

Operation Manual

Single Chamber Toaster
Model 464-B

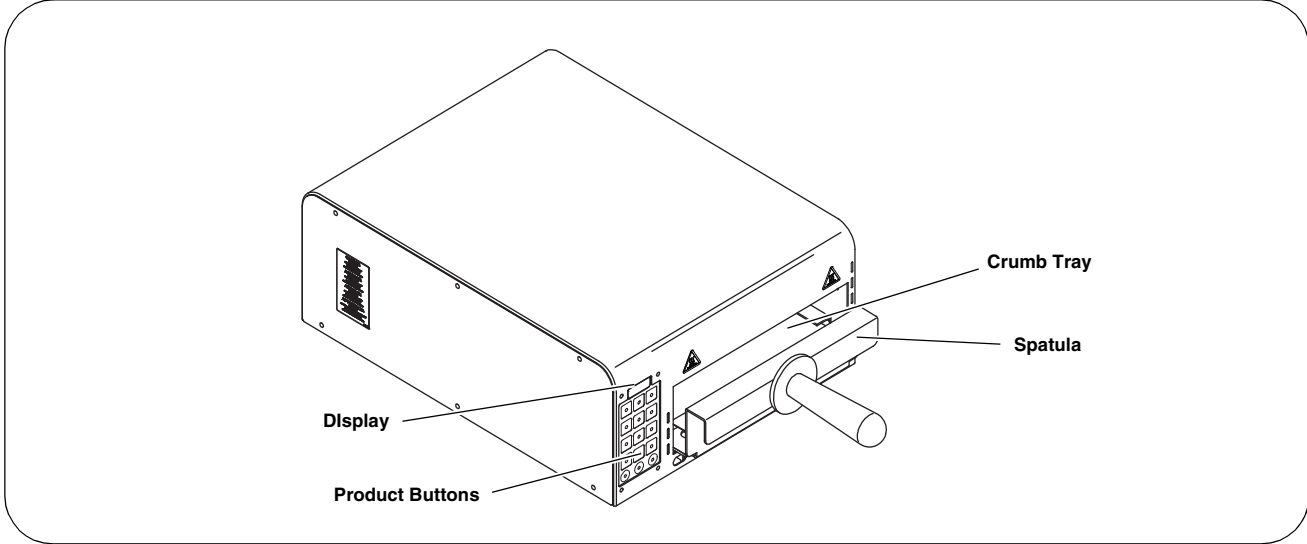

LIMITED WARRANTY

This product is warranted to be free from defects in material and/or workmanship for a period of 1 year from date of original installation, not to exceed 18 months from the date of manufacture.

Any component which proves to be faulty in material and/or workmanship will be replaced or repaired (at the option of Prince Castle, Inc.) without cost to the customer for parts and labor. This equipment is portable; charges for on-location service (e.g., trip charges, mileage) are only included in the first 30 days of this warranty.

This warranty is subject to the following exceptions/conditions:

- Use of any non-genuine Prince Castle parts voids this warranty.
- All labor to be performed during regular work hours. Overtime premium (the incremental amount) will be charged to the customer.
- Damage caused by carelessness, neglect and/or abuse (e.g., dropping, tampering or altering parts, equipment damaged in shipment, by fire, flood or an act of God) is not covered under this warranty.
- All problems due to operation at voltages other than that specified on equipment nameplates are not covered by this warranty. Conversion to correct voltage is the customer's responsibility.

This equipment must be serviced by Prince Castle Authorized Service Agency or a Prince Castle Service Technician during the warranty period.

TABLE OF CONTENTS

Safety Information	2
Important	2
Electrical Specifications	2
Installation	2
Operation	3
Programming Toast Times	4
Programming Alarm Sound Level	5
Factory Default	6
Cleaning	6
Troubleshooting	7
Exploded View and Parts List	8
Wiring Diagram	9



PRINCE CASTLE LLC 
WORLDWIDE



A Marmon Group/Berkshire Hathaway Company

355 East Kehoe Blvd. • Carol Stream, IL 60188 USA
Telephone: 630-462-8800 • Toll Free: 1-800-PCASTLE
Fax: 630-462-1460 • www.princecastle.com

Safety Information

WARNING

Indicates information important to the proper operation of the unit. Failure to observe may result in severe bodily injury or death.

CAUTION

Indicates information important to the proper operation of the unit. Failure to observe may result in damage to the equipment.

NOTE: Damage resulting from any misuse may result in a voided Warranty at the sole discretion of the manufacturer.

Important

Prince Castle reserves the right to change specifications and product design without notice. Such revisions do not entitle the buyer to corresponding changes, improvements, additions or replacements for previously purchased equipment.

Electrical Specifications

Model No.	Volts	Watts	Hz	Phase	Plug
464-B	208 – 240	3030 – 4030	50/60	Single	L6-30P

Installation

1

Remove the unit from the carton and inspect for signs of damage. If there is damage to the unit:

- Notify the carrier within 24 hours of delivery.
- Save carton and packaging materials for inspection purposes.
- Contact your local dealer, or if purchased directly, the Prince Castle Sales Department at 1-800-722-7853 or 630-462-8800 to arrange for a replacement unit.

NOTE: A special packing foam is provided between the heating elements and the protective wire. Be sure to remove this foam prior to operating toaster.

4

Wash, rinse and sanitize spatula prior to use.

Install spatula by sliding it in beneath crumb tray. Spatula to be located in this slot when not toasting product.

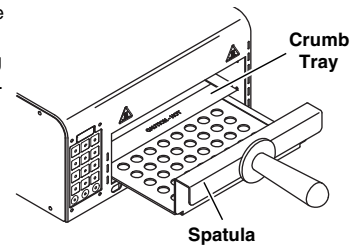

2

Position the Single Chamber Toaster in a well-ventilated area.

NOTE: When installing this unit, the ambient temperature at the site should not exceed 100°F (37.8°C).

5

Insert the three-pin power cord plug into a 208 – 240 VAC 50 – 60 Hz 30A single phase circuit. Once inserted, twist plug to the right and lock into position.

WARNING

All electrical connections must be in accordance with local electrical codes and any other applicable codes.

Plug the unit into an applicable electrical receptacle.

The power cord on this product is rated for a maximum surface temperature of 194°F (90°C). If the cord comes into contact with any heated surface, it may be damaged and/or cause damage to the product and/or injury to the user.

If supply cord is damaged, it must be replaced by the manufacturer, its service agent, or similarly qualified persons in order to avoid a hazard.

3

Unwrap crumb tray and spatula. Install crumb tray on toaster by sliding it into the brackets located on both sides of the heating compartment.

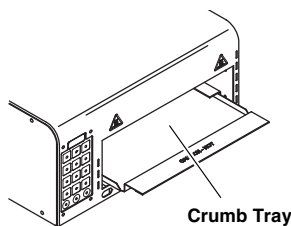

Operation

The following toast times were preset at the factory prior to shipment. Adjustments may be necessary due to variable cut or moisture content of the product (see Programming to adjust).

Recommended Toast Times

Button	Product	Toast Time (sec.)	Button	Product	Toast Time (sec.)
#1	Bakery Style	:55	#6	Jumbo	:55
#2	Roll	:60	#7	Regular	:45
#3	Tortilla	:20	#8	Wheat	:50
#4	Croissant	:30	#9-12	Unassigned	:35
#5	Biscuit	:55			

WARNING

This appliance is not intended for use by persons (including children) with reduced physical, sensory, or mental capabilities, or lack of experience and knowledge unless they have been given supervision or instruction concerning use of the appliance by a person responsible for their safety.

1

While the toaster is OFF (the display is off), press the ON/OFF button once to turn it ON. The display will show the software version for 3 seconds.

NOTE: While the toaster is ON (but not being programmed), pressing the UP Arrow button will display the current temperature of the heater probe.

2

Wait approximately 10 minutes while the toaster warms up. The toaster will display LLL while it is warming up. After warming, the display will show RDY to indicate it is ready for use.



3

Load the spatula with product above the crumb tray and slide the spatula into the toasting chamber. Max 3 buns.

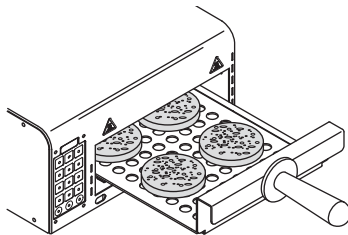

4

To begin a toast cycle, press the desired product button.

The LED associated with this product will light up green, and the toaster's display will change from RDY to the product toast time and begin to count down.

NOTE: To cancel an active toast cycle, press the product button three times within 3 seconds. The LED will go out and the display will stop counting down.



5

At the end of the toast cycle, the product LED will flash green, an audible alarm will sound and the display will read END.

The alarm will stop after pressing any product button, the UP Arrow button or the DOWN Arrow button. The display will revert back to RDY and the LED will turn off.

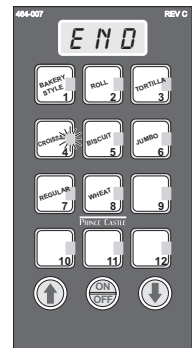

6

To turn the toaster OFF, when no toast cycle is active, press and hold (for 2 seconds) the ON/OFF button.

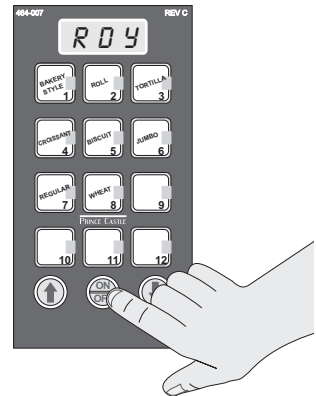

Programming Toast Times

1

NOTE: During programming, if no buttons are pressed for 30 seconds, the toaster will exit programming.

While the toaster is ON, but no toast cycle is active, press and hold (for 6 seconds) both the UP and DOWN Arrow buttons. The display will show SEL.

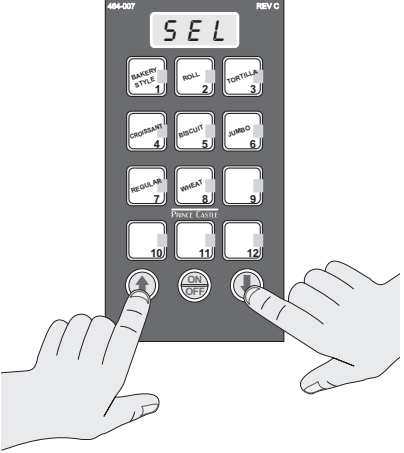

4

To accept the changes, press the product button again. The display will show SEL.

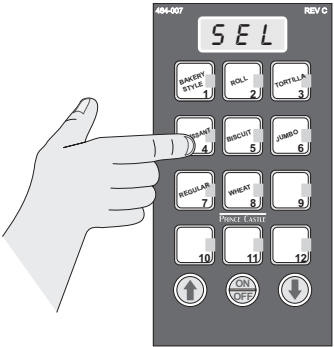

2

Press the product button that you want to program or adjust. Its LED will flash green and the current time for its product will display.

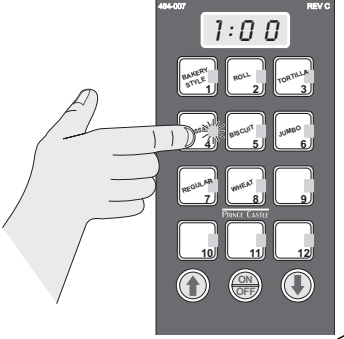

5

To program or adjust the time on the other product buttons, repeat steps 1 - 4.

3

Press the UP Arrow button to increase the time or press the DOWN Arrow button to decrease the time.

Increase Time ↑

↓ Decrease Time

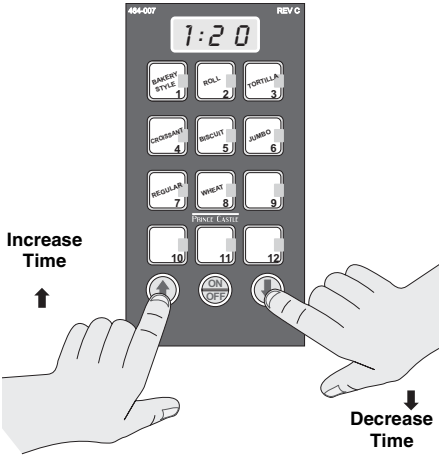

6

To exit programming, press and hold (for 2 seconds) either the UP or DOWN Arrow button.

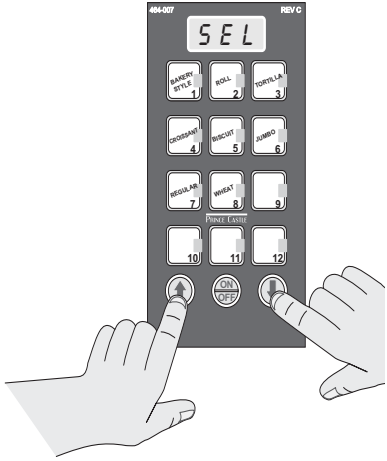

Programming Alarm Sound Level

1

NOTE: During programming, if no buttons are pressed for 30 seconds, the toaster will exit programming.

While the toaster is ON, but no toast cycle is active, press and hold (for 6 seconds) both the UP and DOWN Arrow buttons. The display will show SEL.

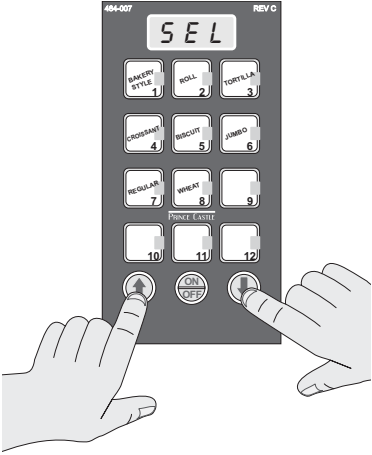

3

Press one of the first eight product buttons to choose a different sound level, where the 1 button is SL0, the 2 is SL1, the 3 is SL2, etc.

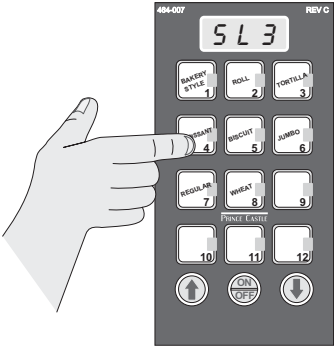

2

Press the UP or DOWN Arrow buttons to display the sound level. The display will show SL (Sound Level) and a number from 0 to 7.

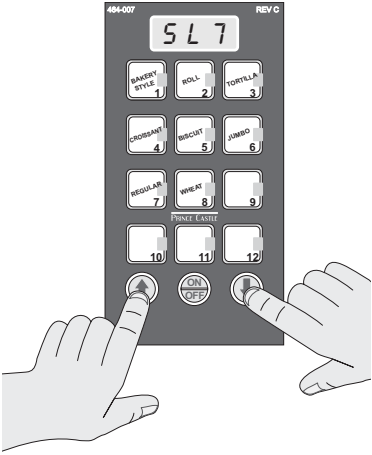

4

To accept the change, press either the UP or DOWN Arrow button. The display will show SEL.

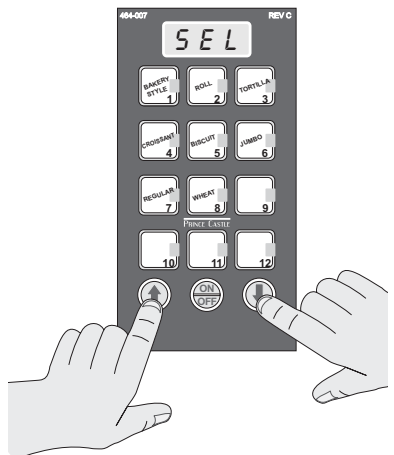

5

To exit programming, again press and hold (for 2 seconds) either the UP or DOWN Arrow button.

Factory Default

1

Follow this procedure if at any time the unit settings need to be reset to the original factory default values.
Unplug the unit and wait 10 seconds.

3

Release the buttons after which the toaster will turn OFF (display goes off).

2

Plug in the toaster and within the next 3 seconds press and hold both the UP Arrow and DOWN Arrow buttons until the display alternates between PrE and SET.

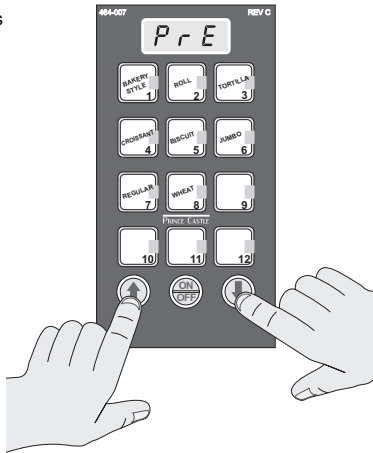

4

Turn on the toaster and the original factory values will have been restored.

Cleaning

1

Turn the toaster OFF and allow it to cool for 20 minutes.
NOTE: Do not unplug the unit while the internal fan is running.

 **WARNING**

BURNELECTRICAL SHOCK HAZARD! Surfaces are **HOT** and can cause severe burns or severe shock. Turn unit OFF and let it cool down completely before cleaning or working on internal apparatus.

 **CAUTION**

Do not get water on the heater. This could cause serious electrical damage to the toaster.
Do not hose down or use a water jet on the unit. Keep unit away from running water.

2

Wipe the toaster with a clean, damp cloth.

 **CAUTION**

Do not use abrasive sponges or scouring pads of any type.
Corrosive cleaners such as oven sprays, cleaners containing chlorine or ammonia and stain removers should not be used.

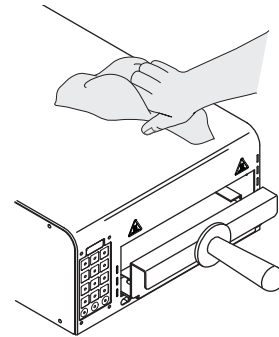

Troubleshooting

Diagnostic Error Codes

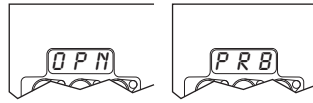

OPN / PRB = Open Probe

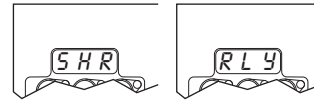

SHR / RLY = Shorted Relay

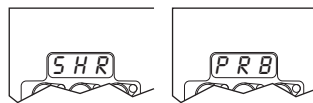

SHR / PRB = Shorted Probe

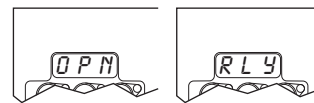

OPN / RLY = Open Relay

Note: If there is a failure on the heater, the toaster cannot be used.

PROBLEM	POSSIBLE CAUSE	SOLUTION
Display reads SHR / RLY OPN / RLY SHR / PRB OPN / PRB	<ol style="list-style-type: none"> 1. Shorted relay. 2. Open relay. 3. Shorted probe. 4. Open probe. 	<ol style="list-style-type: none"> 1. Turn toaster off and call your authorized Prince Castle Service Agent to arrange repair.
Product too light or too dark.	<ol style="list-style-type: none"> 1. Toast time incorrect. 	<ol style="list-style-type: none"> 1. Adjust toast times.
Product button does not activate countdown sequence.	<ol style="list-style-type: none"> 1. Inoperable operate switch. 	<ol style="list-style-type: none"> 1. Turn toaster off and call your authorized Prince Castle Service Agent to arrange repair.
Toaster will not turn on.	<ol style="list-style-type: none"> 1. Unit unplugged. 2. Circuit breaker off. 	<ol style="list-style-type: none"> 1. Plug unit in. 2. Switch circuit breaker on. 3. Contact your authorized Prince Castle Service Agent to arrange repair.

Exploded View and Parts List

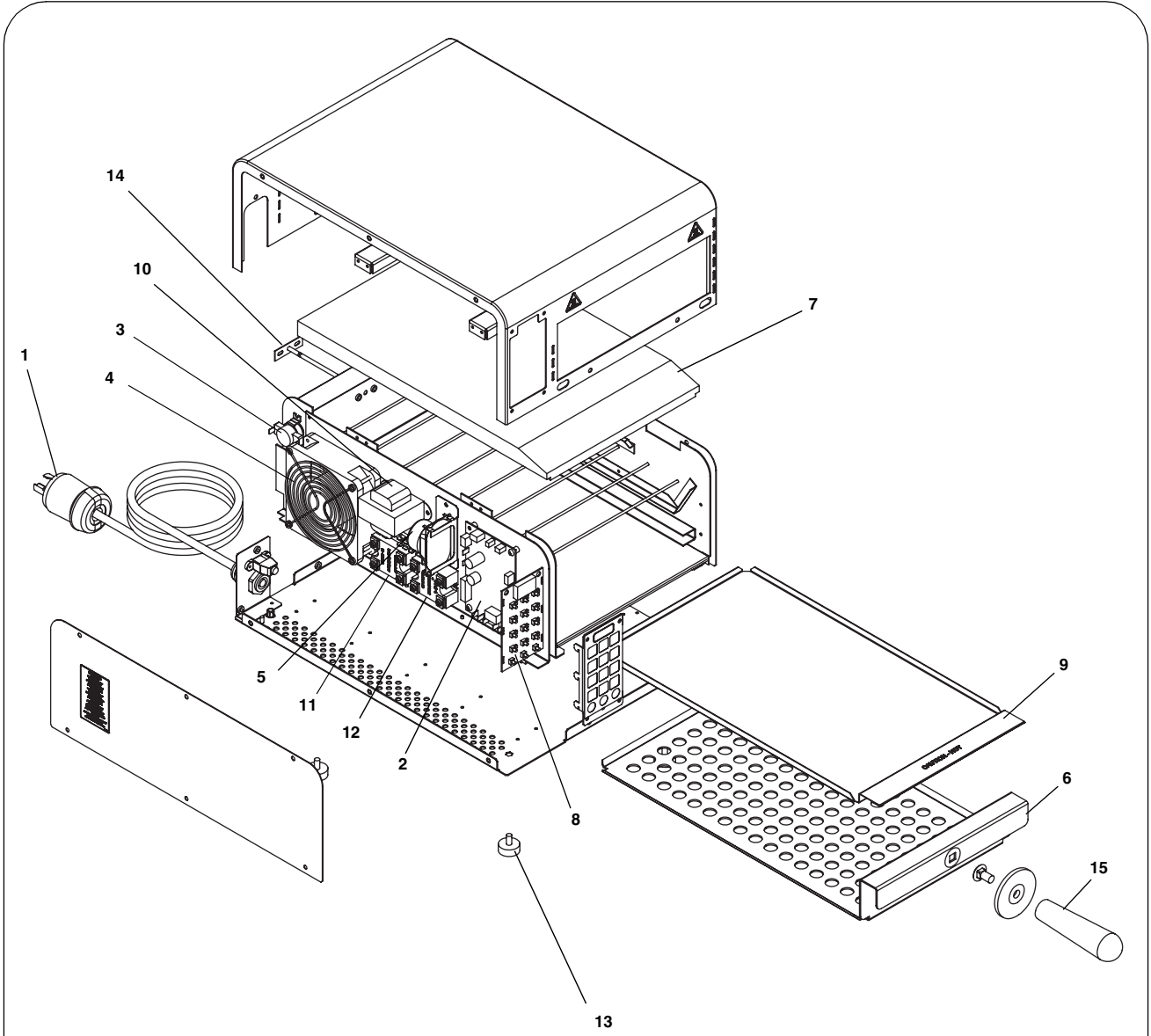

Ref.	Part No.	Description	Ref.	Part No.	Description
1	72-429S	Power Cord	9	424-149S	Crumb Tray
2	464-022S	Main Board Kit	10	307-76S	Transformer Assembly
3	424-170S	Hi-Limit Switch Kit	11	526-064S	Power Relay
4	87-042S	Fan	12	65-058S	SS Relay
5	88-709-2-11S	Speaker Kit	13	197-232S	Foot (Pkg. of 4)
6	464-015S	Spatula	14	464-058S	Probe
7	424-87S	Heater	15	625-097S	Handle Kit
8	464-028S	Display Board			

Wiring Diagram

