

Product Identification

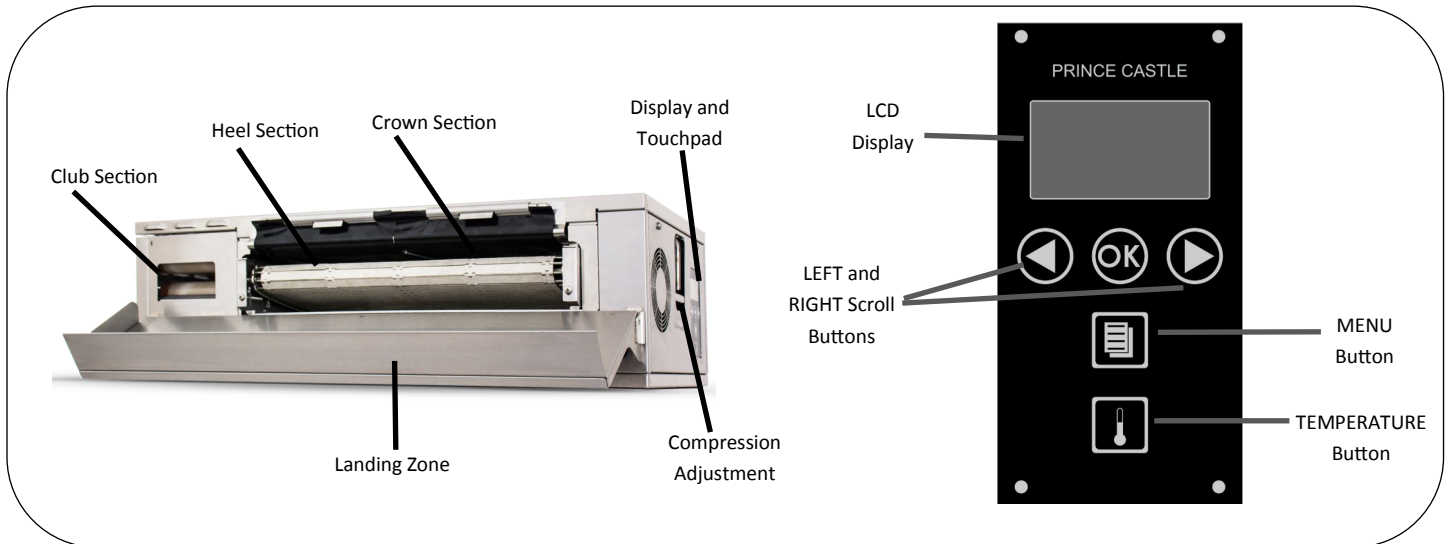

LIMITED WARRANTY

This product is warranted to be free from defects in material and/or workmanship for a period of two (2) years from date of original installation, not to exceed 30 months from date of shipment from our factory. Any part or component which proves to be faulty in material and/or workmanship within the warranty period will be replaced or repaired (at the option of Prince Castle, Inc.) without cost to the customer for parts or labor.

This warranty is subject to the following exceptions/conditions:

- Use of any non-genuine Prince Castle parts voids this warranty and all work must be performed by an authorized Prince Castle Service Agent.
- All labor shall be performed during regular work hours. Overtime premium will not be covered.
- Travel charges are limited to 200 kilometers (100 miles) round trip, 2 hours travel time, one trip per repair.
- Damage caused by carelessness, neglect, and/or abuse (e.g., using wrong current, dropping, tampering with or altering electrical components, or improper cleaning) is not covered.
- Equipment damaged in shipment, by fire, flood or an act of God is not covered.
- Damage to non-stick coated surfaces is not covered by this warranty.



355 East Kehoe Blvd. • Carol Stream, IL 60188 USA
Telephone: 630-462-8800 • Toll Free: 1-800-PCASTLE
Fax: 630-462-1460 • www.princecastle.com

Table of Contents

Product Identification.....	Page 1	Remove/Replace PCB.....	Page 22
Warranty Statement.....	Page 1	Remove/Replace Relay.....	Page 24
Table of Contents.....	Page 2	Remove/Replace Conveyor Belt.....	Page 26
Electrical Specifications.....	Page 3	Remove/Replace Teflon Bars.....	Page 29
Safe Service Practices.....	Page 3	Remove/Replace Motor and Belt Assembly.....	Page 32
Serial Number Matrix.....	Page 3	Remove/Replace Display Assembly.....	Page 34
Tools Required.....	Page 4	Remove/Replace Club Belt.....	Page 35
Fault Identification.....	Page 5	Remove/Replace Club Probe.....	Page 36
Troubleshooting Steps.....	Page 6	Remove/Replace Club Assembly.....	Page 38
Wiring Diagram.....	Page 7	Remove/Replace Platen High Limit Switch.....	Page 40
Test Points.....	Page 8	Allowable Labor Limits.....	Page 43
Exploded View and Parts List.....	Page 12		
Display Menu Options.....	Page 17		
Management Programming.....	Page 19		

Horizontal Core Bun Toaster

CBT-SB-NA-1PS



Electrical Specifications

CBT-SB-NA-1PS 200-240VAC, 50/60 Hz, 1 Ph.

Disconnect Power

 **WARNING**

Failure to turn off the unit before servicing could result in severe bodily injury or death. Switch the On/Off switch to the Off position

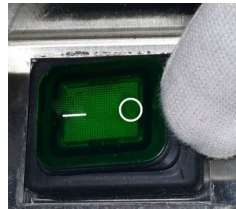

Important

Prince Castle reserves the right to change specifications and product design without notice. Such revisions do not entitle the buyer to corresponding changes, improvements, additions, or replacements for previously purchased equipment.

Safe Service Practices

 **WARNING**

Indicates information important to the proper operation of the unit. Failure to observe may result in damage to the equipment and/or severe bodily injury or death.

 **CAUTION**

Indicates information important to the operation of the unit. Failure to observe may result in damage to the equipment.

GENERAL
This appliance is designed for toasting bread products in a commercial McDonalds kitchen. The dimensions of the bread products as defined

 **CAUTION**

Do not hose down or use a water jet on the unit. Keep the unit away from running water. Disconnect power cord before performing any cleaning or maintenance.

 **CAUTION**

Equipment must be elevated from the floor at all times during cleaning and operation.

Serial Number Matrix

The manufacture date is encoded in the unit's serial number. The service bench installation date (used to determine warranty coverage) is considered to be the end of the following month. For example:

Serial Number: FJ0000458

Manufacture Date: June 2014

Service Bench Installation Date: July 31, 2014

		SERIAL NUMBER MATRIX									
		2014	2015	2016	2017	2018	2019	2020	2021	2022	
		J	K	L	M	N	O	P	Q	R	
January	A	AJ	AK	AL	AM	AN	AO	AP	AQ	AR	
February	B	BJ	BK	BL	BM	BN	BO	BP	BQ	BR	
March	C	CJ	CK	CL	CM	CN	CO	CP	CQ	CR	
April	D	DJ	DK	DL	DM	DN	DO	DP	DQ	DR	
May	E	EJ	EK	EL	EM	EN	EO	EP	EQ	ER	
June	F	FJ	FK	FL	FM	FN	FO	FP	FQ	FR	
July	G	GJ	GK	GL	GM	GN	GO	GP	GQ	GR	
August	H	HJ	HK	HL	HM	HN	HO	HP	HQ	HR	
September	J	JJ	JK	JL	JM	JN	JO	JP	JQ	JR	
October	K	KJ	KK	KL	KM	KN	KO	KP	KQ	KR	
November	L	LJ	LK	LL	LM	LN	LO	LP	LQ	LR	
December	M	MJ	MK	ML	MM	MN	MO	MP	MQ	MR	

Horizontal Core Bun Toaster

CBT-SB-NA-1PS



Tools Required

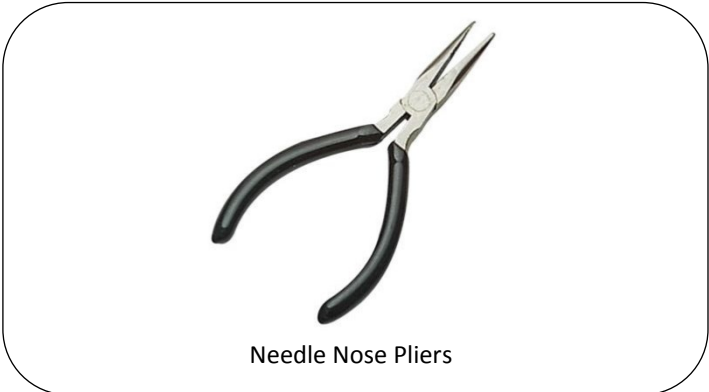
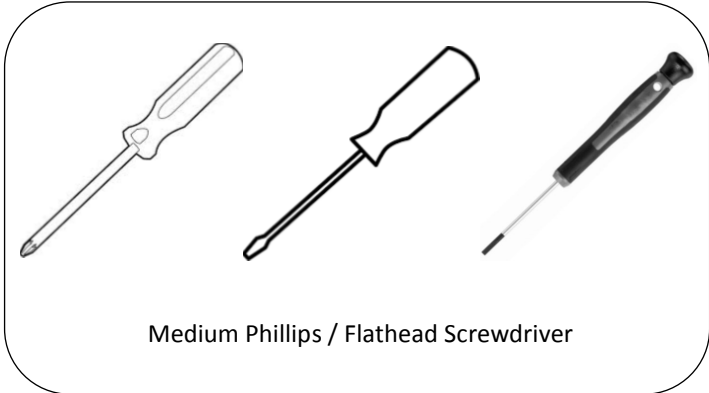

Fault Identification

CBT-MCD ERROR CODE MATRIX					
Error Message to Display		Component Designation	Error code	Problem Description	Action to take
Dual Display Mode					
Initial screen (1.5 sec.)	Toggle Screen (1.5 sec.)	Main Platen	10	Probe shorted	Shut off power to the toaster, wait 30 seconds and turn back on. If the error code is still present or reappears within 24 hours, call for service.
Main Probe Shorted	N/A				
Call for service					
Initial screen (1.5 sec.)	Toggle Screen (1.5 sec.)	Main Platen	11	Probe open	Shut off power to the toaster, wait 30 seconds and turn back on. If the error code is still present or reappears within 24 hours, call for service.
Main Probe Open	N/A				
Call for service					
Initial screen (1.5 sec.)	Toggle Screen (1.5 sec.)	Main Platen	12	Redundant heater switchover mode	Shut off power to the toaster, wait 30 seconds and turn back on. If the error code is still present or reappears within 24 hours, call for service.
Heater switch-over mode	N/A				
Call for service					
Initial screen (1.5 sec.)	Toggle Screen (1.5 sec.)	Main Platen	13	Redundant heater switchover error	Shut off power to the toaster, wait 30 seconds and turn back on. If the error code is still present or reappears within 24 hours, call for service.
Heater switch-over error	N/A				
Call for service					
Initial screen (1.5 sec.)	Toggle Screen (1.5 sec.)	Front Club Platen	20	Probe shorted	Shut off power to the toaster, wait 30 seconds and turn back on. If the error code is still present or reappears within 24 hours, call for service.
Front Club Probe shorted	N/A				
Call for service					
Initial screen (1.5 sec.)	Toggle Screen (1.5 sec.)	Front Club Platen	21	Probe open	Shut off power to the toaster, wait 30 seconds and turn back on. If the error code is still present or reappears within 24 hours, call for service.
Front Club Probe open	N/A				
Call for service					
Initial screen (1.5 sec.)	Toggle Screen (1.5 sec.)	Front Club Platen	22	Heater temperature drifted too low for too long. 25F below setpoint for 5 minutes.	Shut off power to the toaster, wait 30 seconds and turn back on. If the error code is still present or reappears within 24 hours, call for service.
Front Club Low temp error	Power ON				
Power OFF	If problem exist				
Wait 30 seconds	Call for service				
Initial screen (1.5 sec.)	Toggle Screen (1.5 sec.)	Rear Club Platen	30	Probe shorted	Shut off power to the toaster, wait 30 seconds and turn back on. If the error code is still present or reappears within 24 hours, call for service.
Rear Club Probe shorted	N/A				
Call for service					
Initial screen (1.5 sec.)	Toggle Screen (1.5 sec.)	Rear Club Platen	31	Probe open	Shut off power to the toaster, wait 30 seconds and turn back on. If the error code is still present or reappears within 24 hours, call for service.
Rear Club Probe open	N/A				
Call for service					
Initial screen (1.5 sec.)	Toggle Screen (1.5 sec.)	Rear Club Platen	32	Heater temperature drifted too low for too long. 25F below setpoint for 5 minutes.	Shut off power to the toaster, wait 30 seconds and turn back on. If the error code is still present or reappears within 24 hours, call for service.
Rear Club Low temp error	Power ON				
Power OFF	If problem exist				
Wait 30 seconds	Call for service				
Initial screen (1.5 sec.)	Toggle Screen (1.5 sec.)	Motor	40	Motor tach error	Shut off power to the toaster, wait 30 seconds and turn back on. If the error code is still present or reappears within 24 hours, call for service.
Motor speed error	Power ON				
Power OFF	If problem exist				
Wait 30 seconds	Call for service				
Initial screen (1.5 sec.)	Toggle Screen (1.5 sec.)	Motor	41	Motor load error	Shut off power to the toaster, wait 30 seconds and turn back on. If the error code is still present or reappears within 24 hours, call for service.
Motor load error	Power ON				
Power OFF	If problem exist				
Wait 30 seconds	Call for service				

Troubleshooting Steps

BURN/ELECTRICAL SHOCK HAZARD! Platen is HOT and can cause severe burns or severe shock.
Keep hands and objects out of the toaster unit! Failure to exercise caution may result in serious injury!
Turn the unit off, unplug it and let it cool down completely before touching or working on internal apparatus.

Master Display Messages		
PROBLEM	PROBABLE CAUSE	SOLUTION
Unit will not heat up	No power to unit.	Ensure power cord is connected to proper receptacle.
	Inoperable power cord	Call for Service (800) 722-7853
	Loose connection on power switch	Call for Service (800) 722-7853
	Inoperable power switch	Call for Service (800) 722-7853
	High limit switch tripped	Call for Service (800) 722-7853
	Inoperable Temperature Probe	Call for Service (800) 722-7853
	Inoperable Platen	Call for Service (800) 722-7853
Unit heats up, but the conveyor does not run	Loose motor switch connection.	Call for Service (800) 722-7853
	Inoperable motor.	Call for Service (800) 722-7853
	Inoperable motor switch.	Call for Service (800) 722-7853
	Stripped drive gear	Call for Service (800) 722-7853
	Loose chain sprockets	Call for Service (800) 722-7853
Unit under-and over-heats, but does not respond to programming.	Check temperature settings	Adjust temperature set point setting. See management programming.
	Inoperable temperature probe	Call for Service (800) 722-7853
Buns under-or over-done.	Check platen adjustment. See operation manual	Move platen adjustment to the correct product part setting.
	Check conveyor temperature. From READY screen, press the INFORMATION button to display the actual	Adjust temperature set point setting. See management programming.
	Improper toast time.	Adjust toast time as needed.

Wiring Diagram

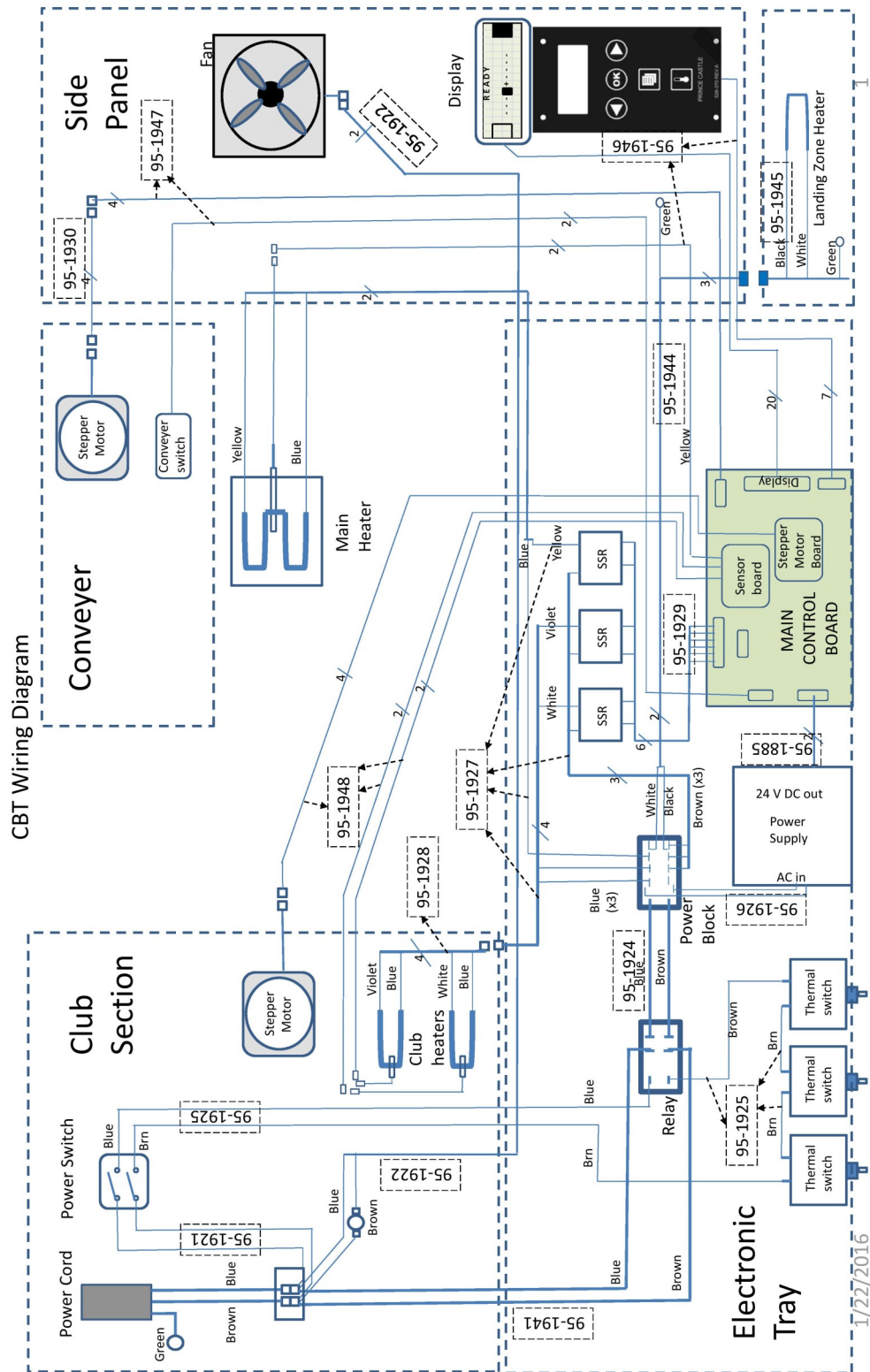

Test Points

Test Points	Operating Ranges for CBT	
	Component	Operating Range
1	Main Platen	15-20Ω
2	Club Platen Top	37-42 Ω
3	Club Platen Bottom	37-42 Ω
4	Main Sensor Probe	1084 Ω @ Room temperature
5	Club sensor probe top	1084 Ω @ Room temperature
6	Club sensor probe bottom	1084 Ω @ Room temperature
7	Heater relays	4-32 VDC Input 24-280 VAC Output
8	AC fan	440-450 Ω

Exploded View and Parts List

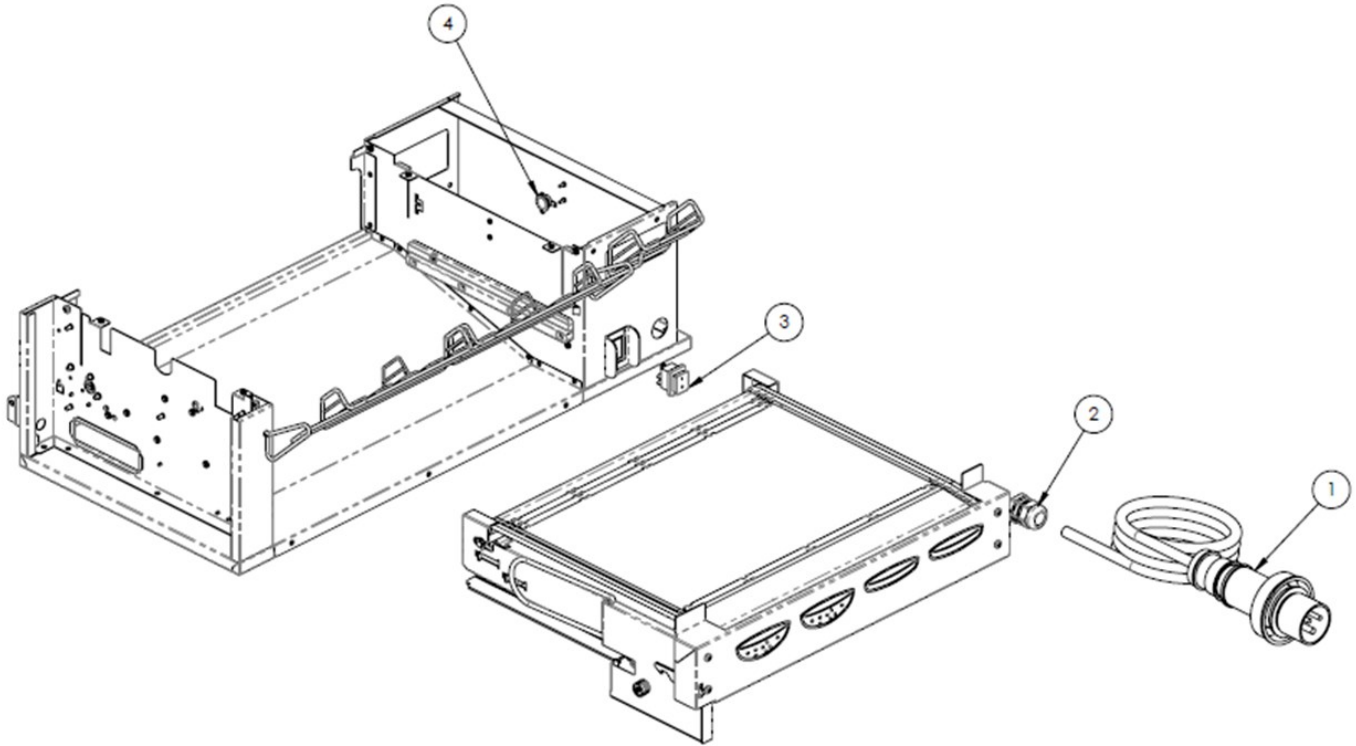

Item #	Part #	Description	Qty
1	72-477	POWERCORD	1
2	66-045S	STRAIN RELEIF	1
3	78-223S	SWITCH, ROCKER, DPST, IP65, 16A	1
4	353-394S	THERMOSTAT, SNAP DISC CONTROL, 120	1
NOT SHOWN	527-127S	SERVICE KIT, CUTOFF SWITCH314	1
NOT SHOWN	353-206S	TRAY, OUTFEED ASSY	1

Exploded View and Parts List (Continued)

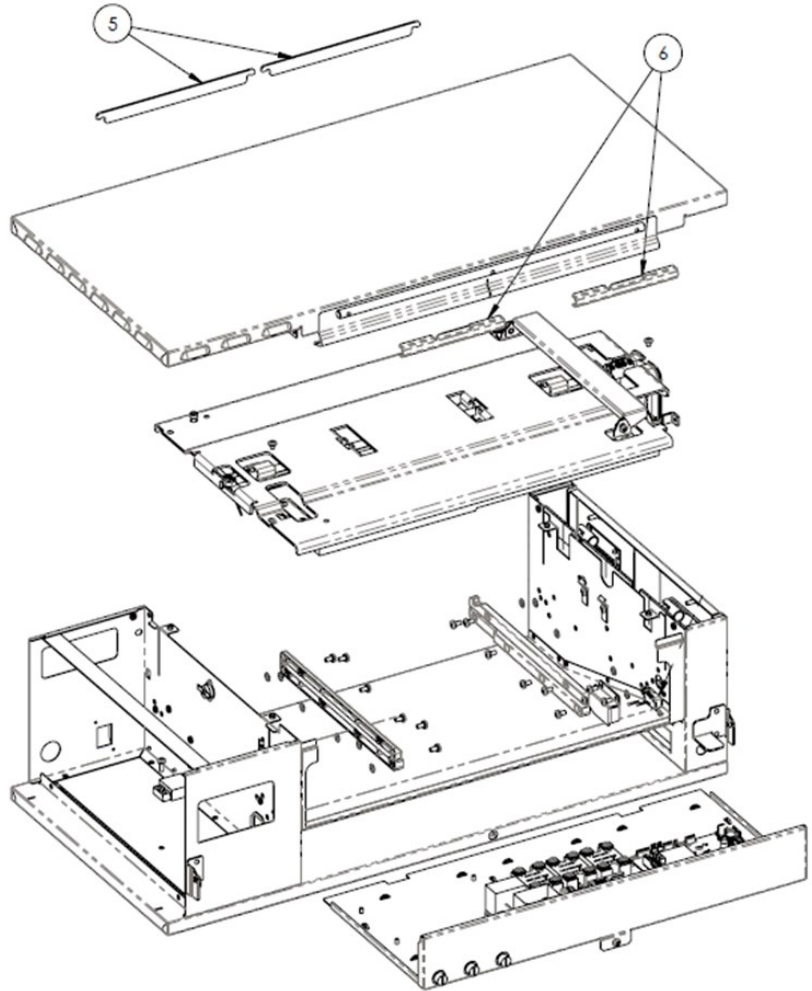

Item #	Part #	Description	Qty
5	353-054S	RELEASE SHEET BAR	2
6	353-053S	RELEASE SHEET CLIP	2

Exploded View and Parts List (Continued)

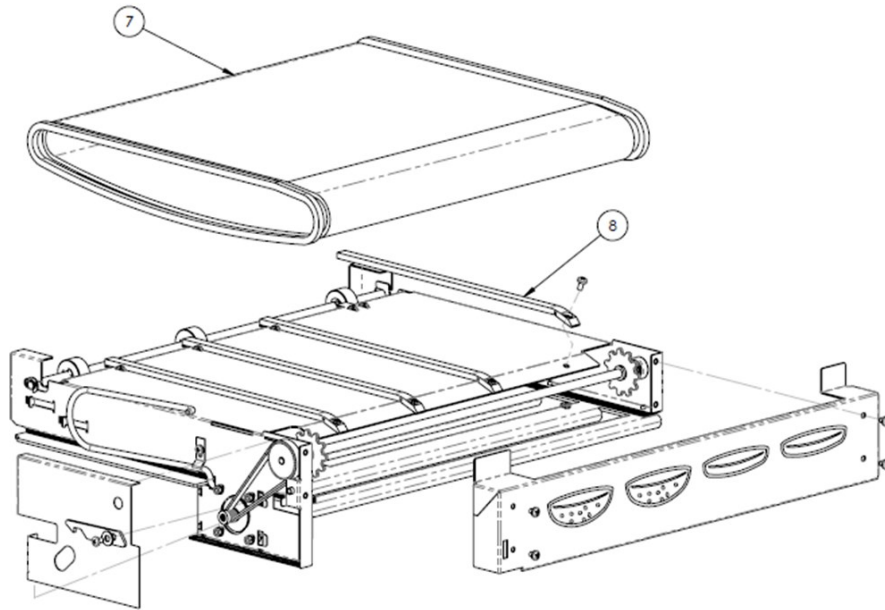

Item #	Part #	Description	Qty
7	353-300S	CONVEYOR, MAIN	1
8	353-442S	SKID BAR, CONVEYOR	4

Exploded View and Parts List (Continued)

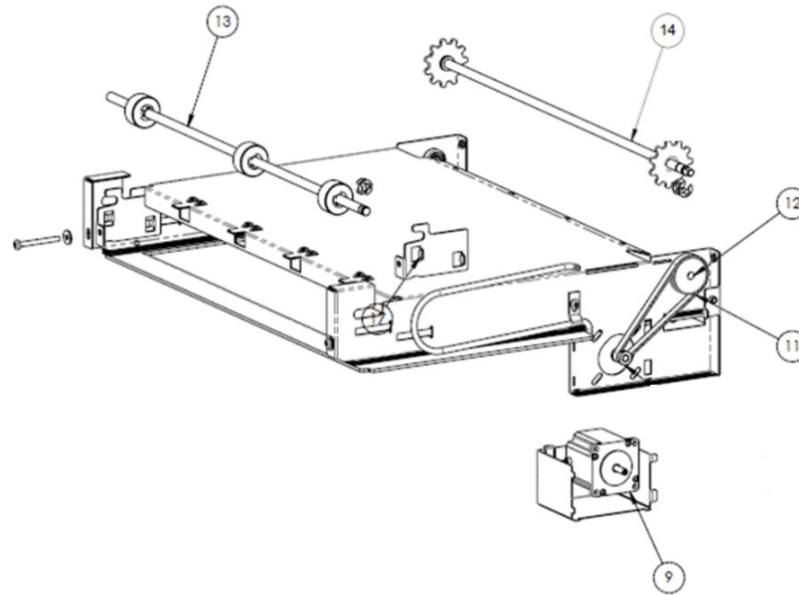

Item #	Part #	Description	Qty
9	353-241S	STEPPER MOTOR	2
11	353-333S	BELT 3MM HTD 106 TEETH	1
12	353-343S	PULLEY, 3MM PITCH .44 GROOVE	2
13	353-257S	SHAFT, TENSIONING ASSY	1
14	353-205S	CONVEYOR SPROCKET SHAFT ASSY	1

Exploded View and Parts List (Continued)

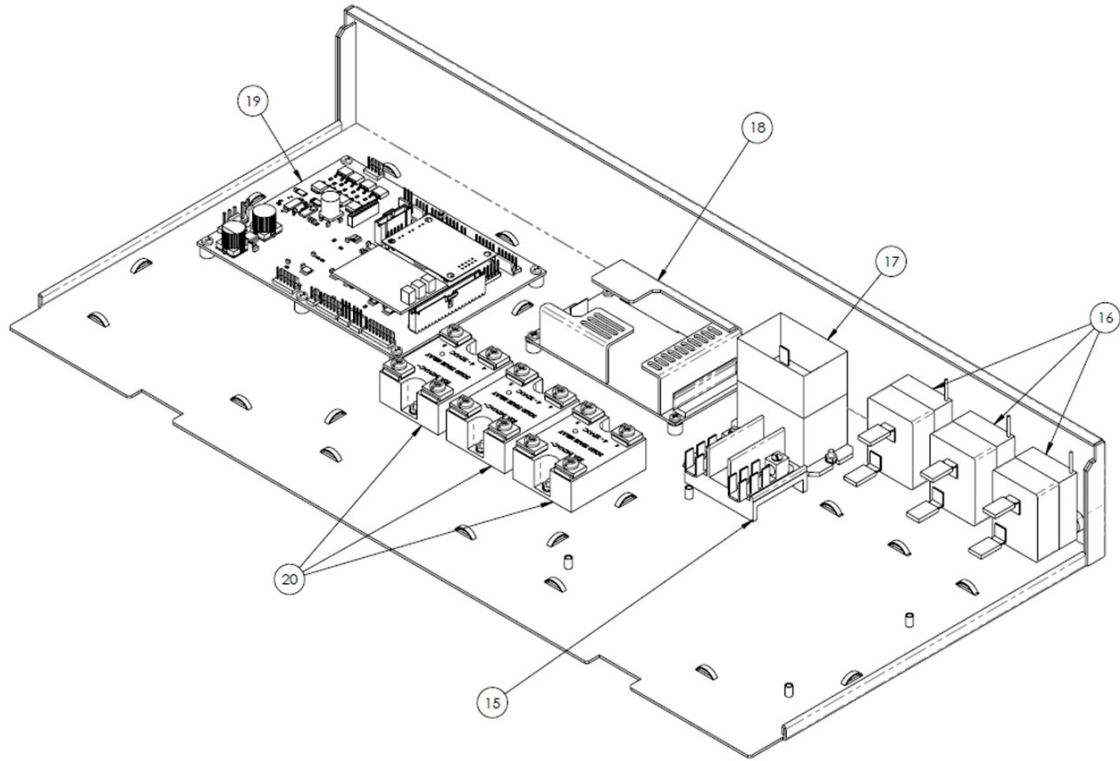

Item #	Part #	Description	Qty
15	77-093S	TERMINAL BLOCK 12POS 2ROW INSULATED	1
16	526-281S	TSTAT, HI-LIMIT BULB & CAP, 700F	3
17	65-067S	RELAY, DPST, 30A, 200/240, 50/60	1
18	85-144-24S	PWER SUPPLY, 24VDC 100W	1
19	353-262CS	PCB, MAIN CONTROLLER	1
20	65-058S	RELAY, SS,50A,280VAC,3-32VDC	3

Exploded View and Parts List (Continued)

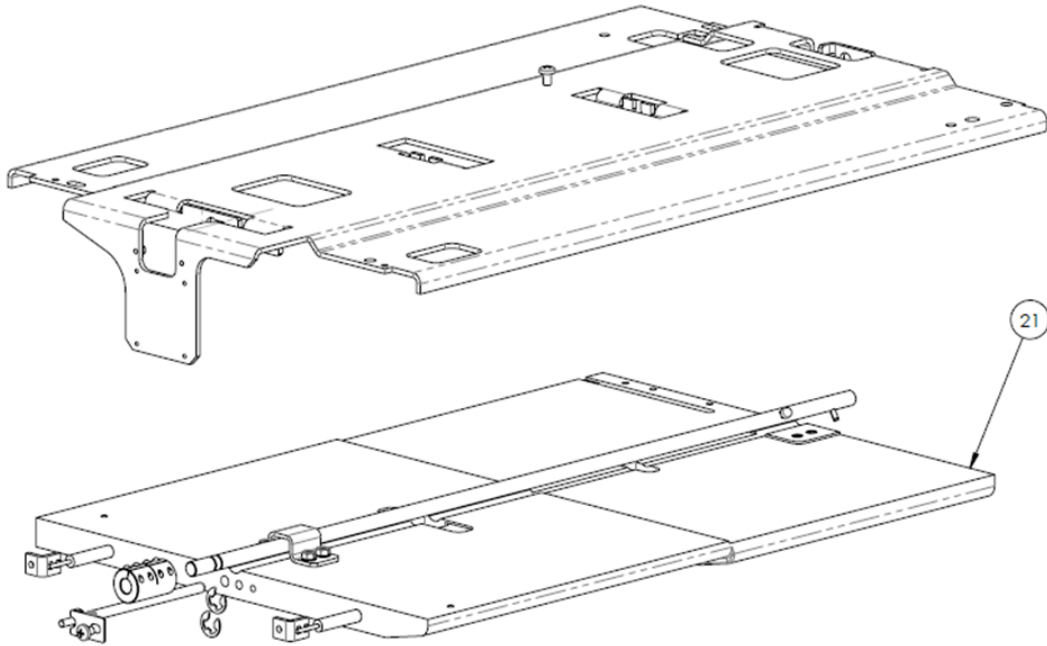

Item #	Part #	Description	Qty
21	353-208S	HEATER PLATEN	1

Exploded View and Parts List (Continued)

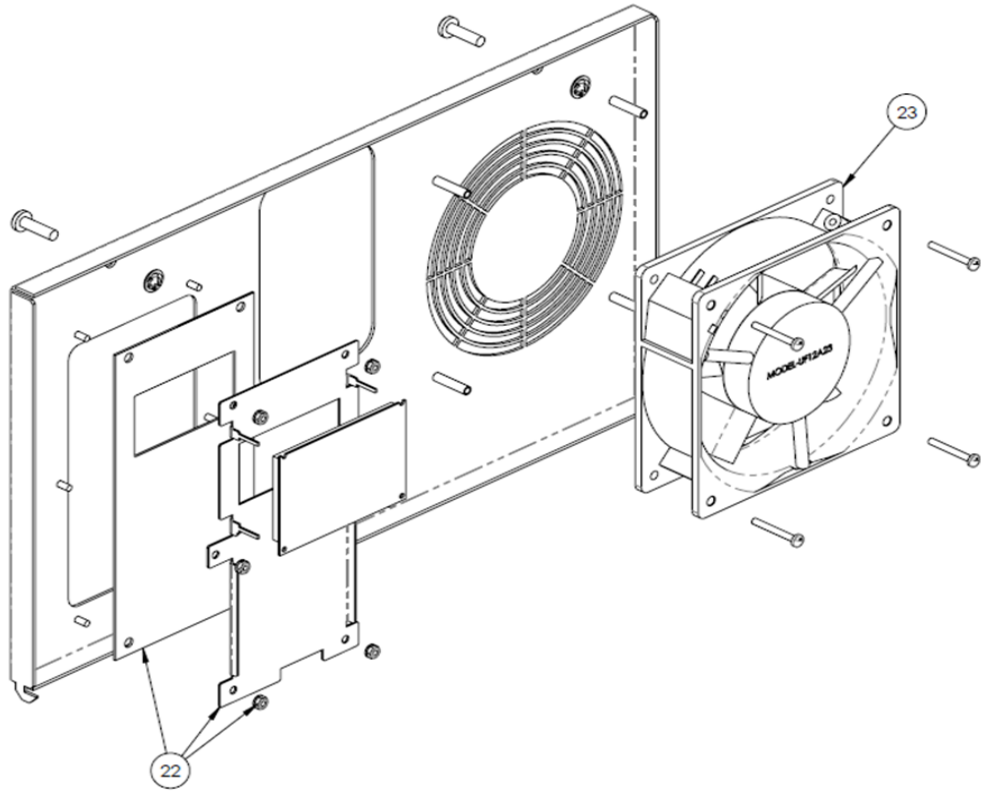

Item #	Part #	Description	Qty
22	527-370S	ASSY, MEMBRANE SWITCH & OVERLAY	1
23	37814S	MOTOR FAN 230V UF12A23	1

Exploded View and Parts List (Continued)

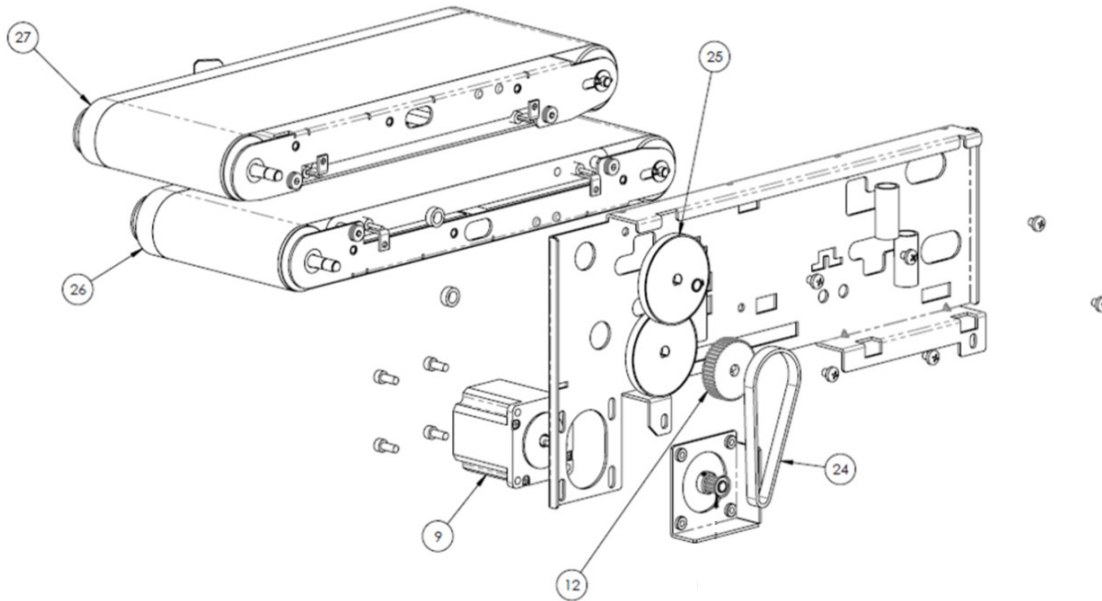

Item #	Part #	Description	Qty
9	353-242S	STEPPER MOTOR	2
12	353-343S	PULLEY, 3MM PITCH .44 GROOVE	2
24	353-357S	BELT 3MM 80 TEETH	1
25	527-819S	GEAR, SPUR,56,TEETH,24.P,2.33P.D..25	2
26	353-233S	CLUB ASSY BOTTOM	1
27	353-231S	CLUB ASSY TOP	1
NOT SHOWN	527-822S	CLUB PROBE TOP	1
NOT SHOWN	527-636S	CLUB PROBE BOTTOM	1

Display Menu Options

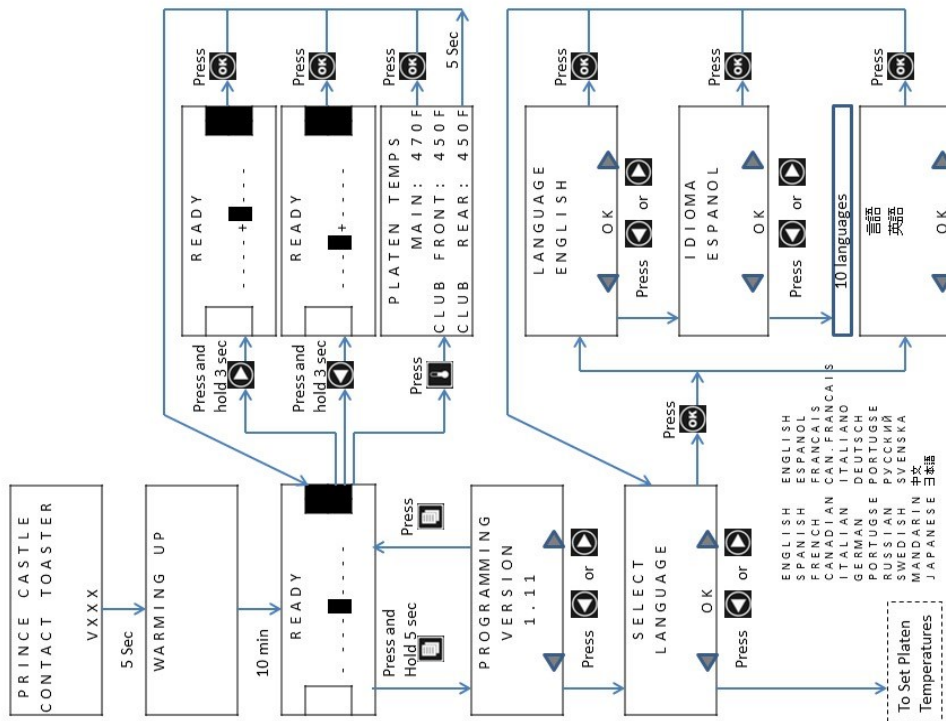
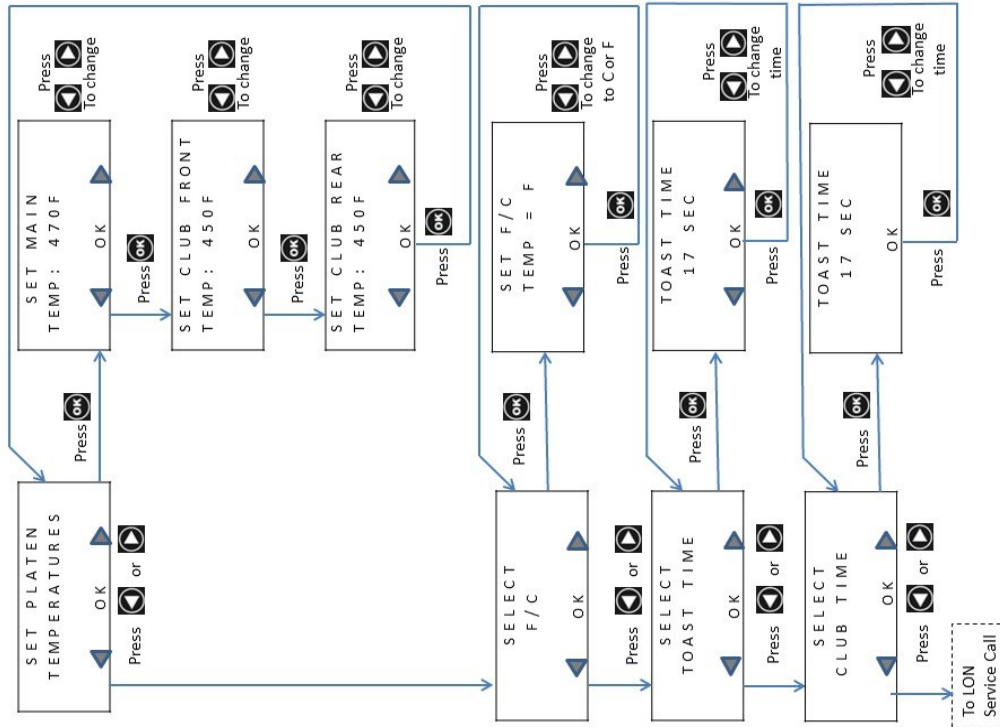

Display Menu Options (Continued...)

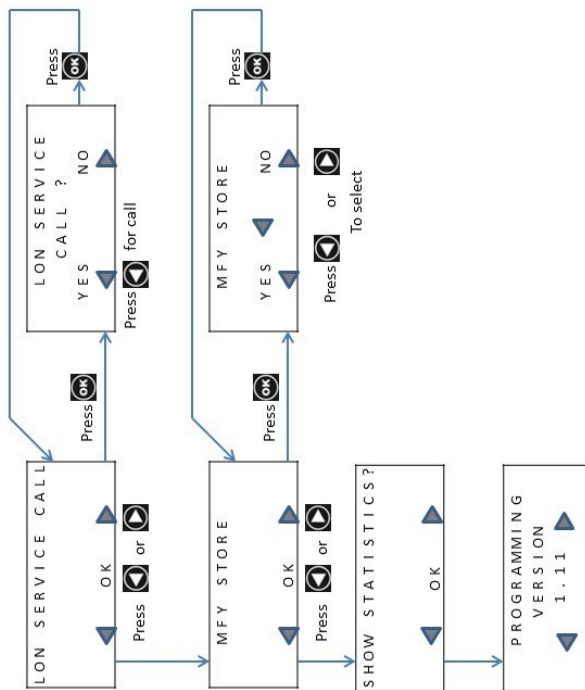

Management Programming

1

To Enter Programming screens
 Press and hold the MENU button for 6 seconds. The PROGRAMMING VERSION screen will appear in the LCD display.

From the PROGRAMMING VERSION screen, you may:

Press RIGHT scroll button to advance to the next menu item

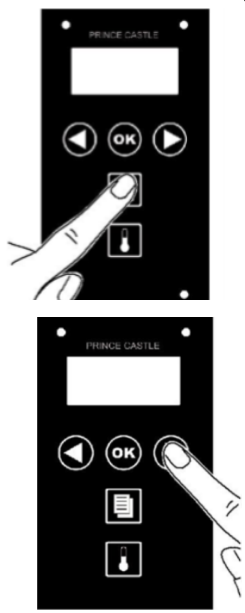

3

To Adjust PLATEN TEMPERATURE from the SELECT LANGUAGE Screen, press the RIGHT scroll button. Press the OK button to enter the programming screen.

A. From the PLATEN TEMPERATURE screen that appears adjust the temperature using the RIGHT and LEFT scroll buttons.

Accept the new Temperature by pressing OK.

NOTE : To cancel without accepting the new setting, press the MENU logo button to return to the previous screen

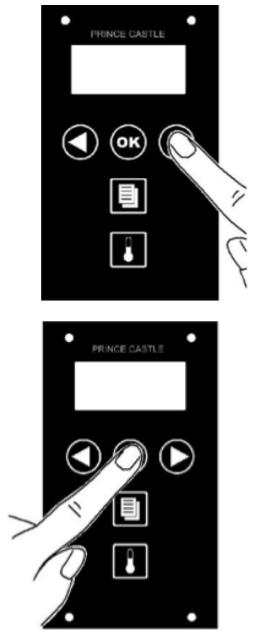

2

To Change the LANGUAGE from the PROGRAMMING VERSION

Screen, PRESS the left scroll button.

From the SELECT LANGUAGE Screen, Press OK button

- A. From the LANGUAGE screen that appears, use the RIGHT and LEFT scroll buttons. TO select different Language
- B. Accept the new language by pressing OK button to return to the SELECT LANGUAGE screen

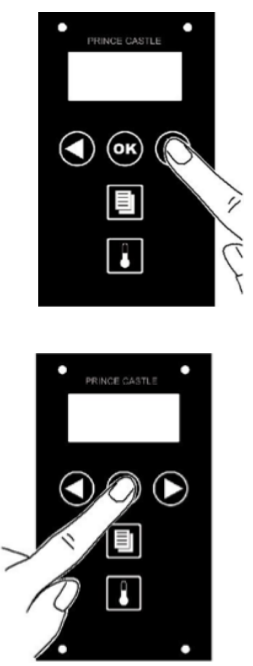

4

To adjust SELECT F/C From The PLATEN TEMPERATURE screen, press the RIGHT scroll button.

From the SELECT F/C screen that appears, press the OK button.

- A. From the SET F/C Screen that appears, Use the LEFT and RIGHT scroll buttons to Select TEMP = F (Fahrenheit) or C (Celsius)
- B. Accept the new scale By pressing the OK Button to return to The SELECT F/C screen

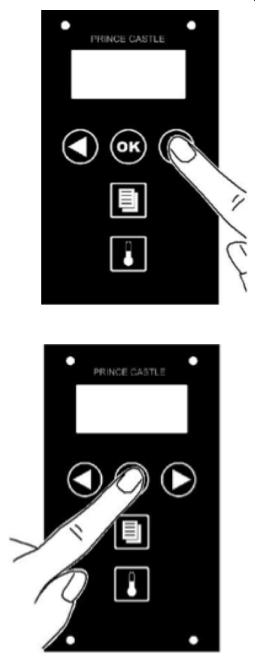

Management Programming (Continued)

5

To adjust set TOAST TIME from the SELECT F/C screen, press the RIGHT scroll button



From the SELECT TOAST TIME Screen, Press OK button

- A. From the SELECT TOAST TIME that appears, Adjust the set point Time Using the RIGHT and LEFT Scroll buttons. Accept The new toast time by Pressing OK.



NOTE : To cancel without accepting the new setting, press the MENU logo button to return to the previous screen

6

To adjust CLUB TOAST TIME from the SELECT TOAST TIME screen, press the RIGHT scroll button

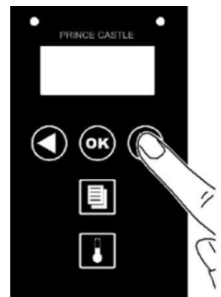

From the SELECT CLUB TOAST TIME Screen, Press OK button

- A. From the SELECT CLUB TOAST TIME that appears, Adjust the set point Time Using the RIGHT and LEFT Scroll buttons. Accept The new toast time by Pressing OK.



NOTE : To cancel without accepting the new setting, press the MENU logo button to return to the previous screen

7

To enter LON SERVICE CALL from CLUB TOAST TIME screen, press the RIGHT scroll button.

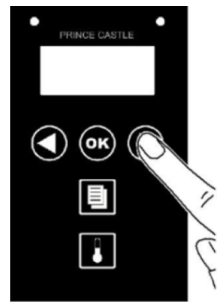

From the LON SERVICE CALL Screen, Press OK button

From the LON SERVICE CALL screen that appears, the following options are available

- YES = LEFT scroll button
- NO = RIGHT scroll button
- OK = Cancel / Go Back

8

To enter MFY STORE from LON SERVICE CALL screen, press the RIGHT scroll button.



From the MFY STORE Screen, Press OK button

From the MFY STORE screen that appears, the following options are available

- YES = LEFT scroll button
- NO = RIGHT scroll button
- OK = Cancel / Go Back

Management Programming (Continued)

9

To view Service Codes, From the MFY Store screen, press the RIGHT scroll button once.

From the Service Codes screen,

- A. Select OK to check the service codes
- B. Refer to Service codes page to understand the operation of the unit.

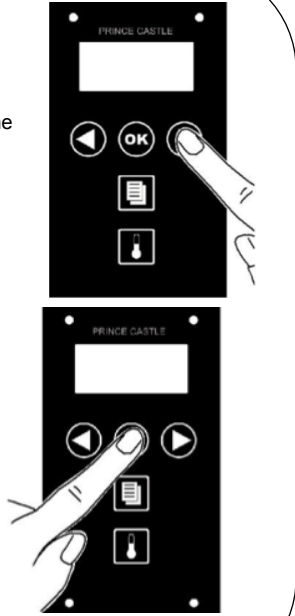

10

Exit Programming

Press the MENU button from any screen to exit programming mode.

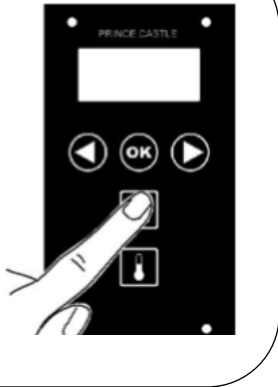

Horizontal Core Bun Toaster

CBT-SB-NA-1PS

Remove/Replace PCB

1 Unplug the unit



WARNING

Failure to disconnect power from the unit before servicing could result in severe bodily injury or death. The ON/OFF Switch does not disconnect incoming power to the unit.

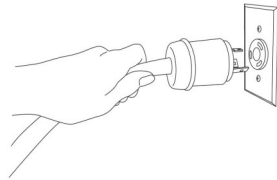

2 Remove the bun landing zone from the unit

3 Loosen the bottom screw to access the electronics tray. Reference the **Red Arrow**.

4 Pull on the screw to slide the electronics tray open

5 Remove the (10) connectors from master control board. Reference the **Black Arrows**.

6 Remove (4) screws to unsecure the master control board. Reference the **Blue Arrows**.

7 Remove the Board

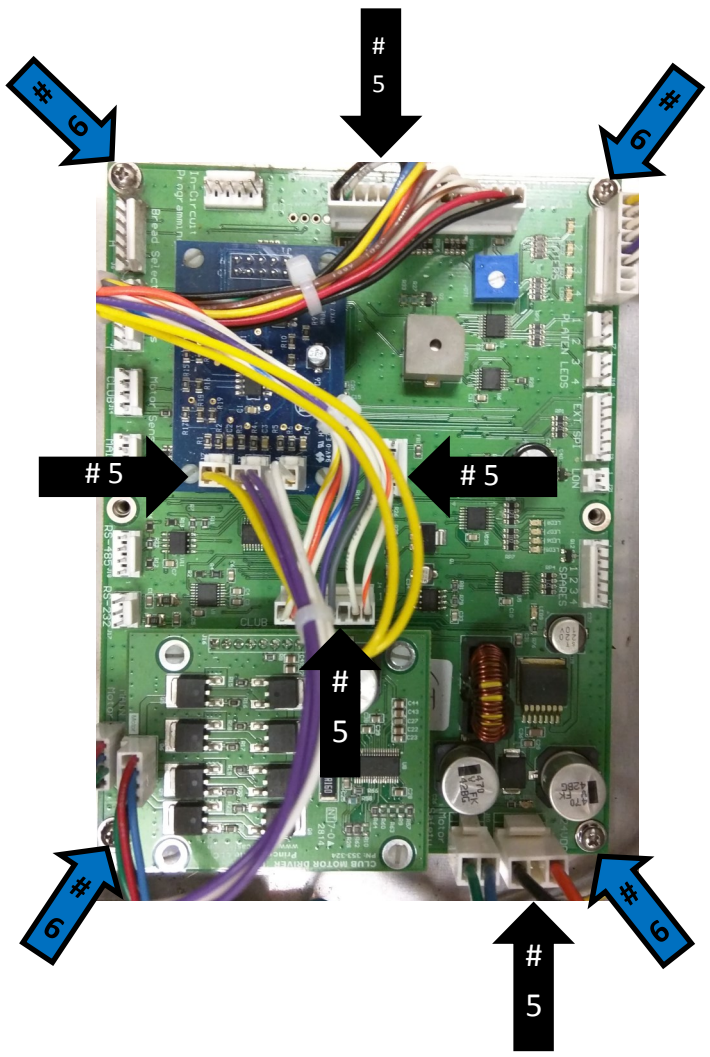

Remove/Replace PCB

- 8 Install the new board
- 9 Using the (4) screws removed in step 6, secure the board onto the electronics tray
- 10 Reconnect (10) connections onto board that were removed in step 5.
- 11 Slide the electronics tray back into unit.
- 12 Tighten the screw to secure the electronics tray.
- 13 Re-install the bun landing zone to the unit
- 14 Plug in Unit, ensure the unit is fully functional.

Horizontal Core Bun Toaster

CBT-SB-NA-1PS

Remove/Replace Relay

1 Unplug the unit

 **WARNING**

Failure to disconnect power from the unit before servicing could result in severe bodily injury or death. The ON/OFF Switch does not disconnect incoming power to the unit.

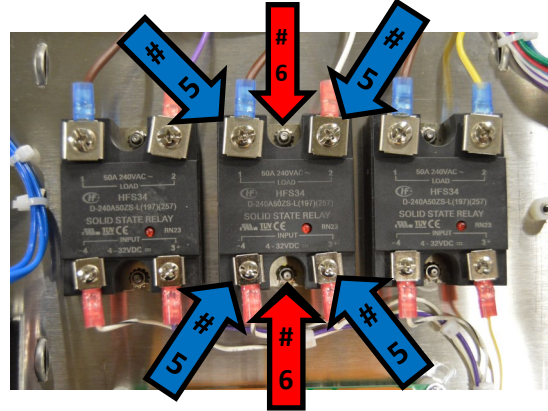
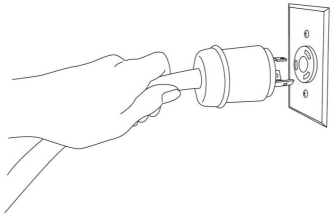

2 Remove the bun landing zone from the unit

3 Loosen the bottom screw to access the electronics tray. Refer to the **Yellow Arrow**

4 Pull on the screw to slide the electronics tray open

5 Remove (4) connectors from relay (Note the position of each connector). Refer to the **Blue Arrows**

6 Remove (2)- 3mm nuts to release the relay from the electronics tray. Refer to the **Red Arrows**

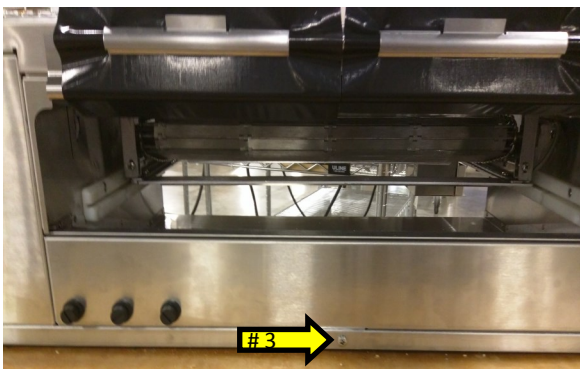
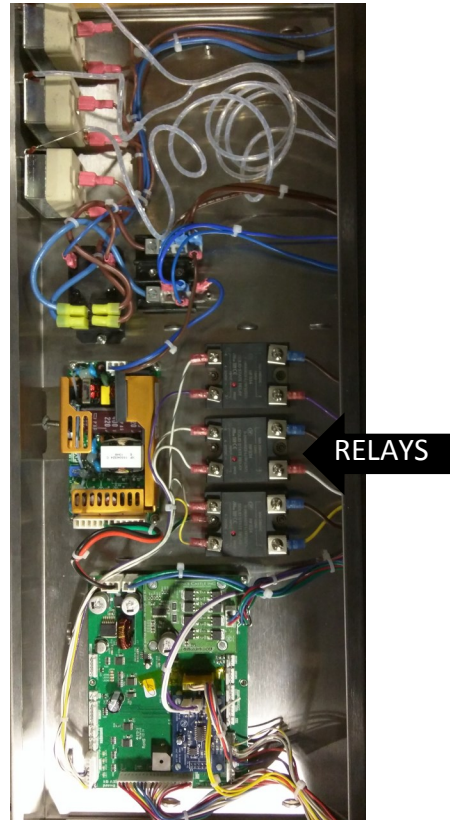

Remove/Replace Relay

7 Install the relay using the (2)- 3mm nuts removed in Step 6

8 Install the (4) connectors that were removed in step 5 back onto the relay.

9 Install the relay using the (2)- 3mm nuts removed in Step 6

10 Slide the electronics tray back into unit.

11 Tighten the screw to secure the electronics tray.

12 Re-install the bun landing zone to the unit

13 Plug in Unit, ensure the unit is fully functional.

Horizontal Core Bun Toaster

CBT-SB-NA-1PS



Remove/Replace Conveyor Belt

1 Unplug the unit

 **WARNING**

Failure to disconnect power from the unit before servicing could result in severe bodily injury or death. The ON/OFF Switch does not disconnect incoming power to the unit.

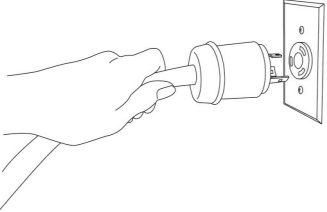

2 Remove the In-Feed Rack

3 Release tension on the conveyor belt by removing (2) screws on rear side of unit. Refer to the **Blue Arrows**

4 Remove the front cover by removing the (4) screws. Refer to the **Red Arrows**

5 Push in the release knob, then pull the conveyor assembly out

6 Find the master link on belt. Refer to the **Yellow Arrow**

7 Un-cripp the master linkage on both sides. Use pliers to remove. Refer to the **Green Arrows**.

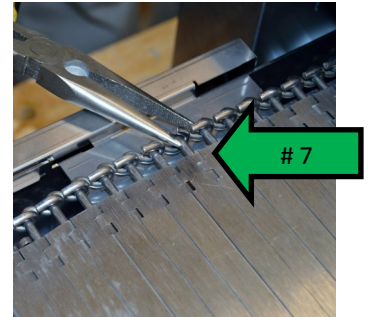
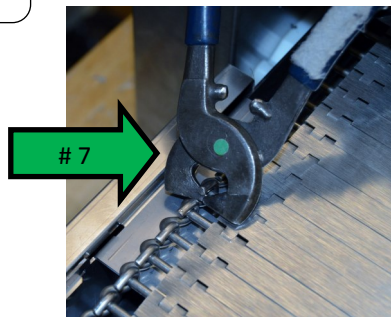
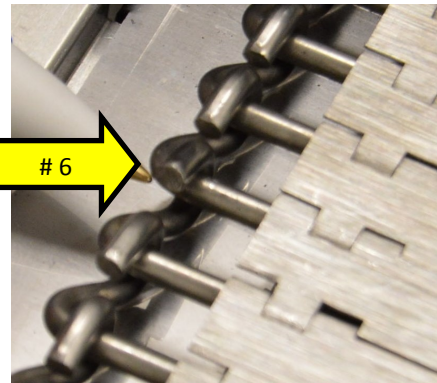
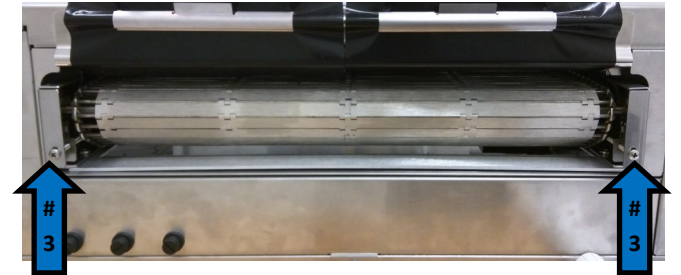

Remove/Replace Conveyor Belt (Cont..)

8 Slide master links out from each side. Refer to the **Black Arrows**

9 Pull conveyor belt out.

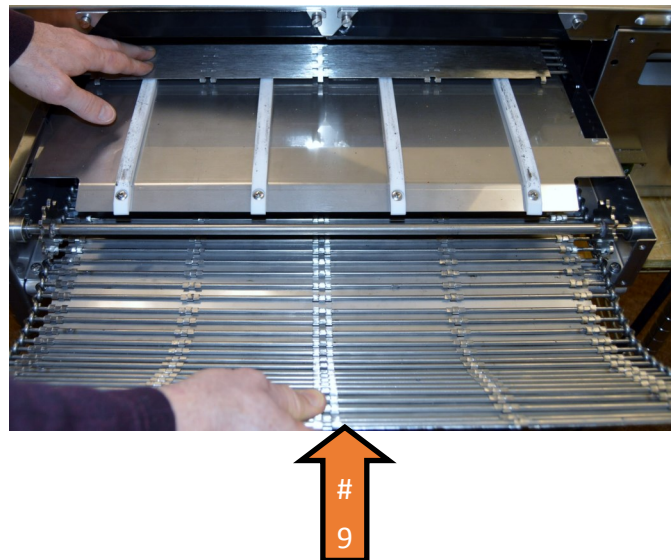
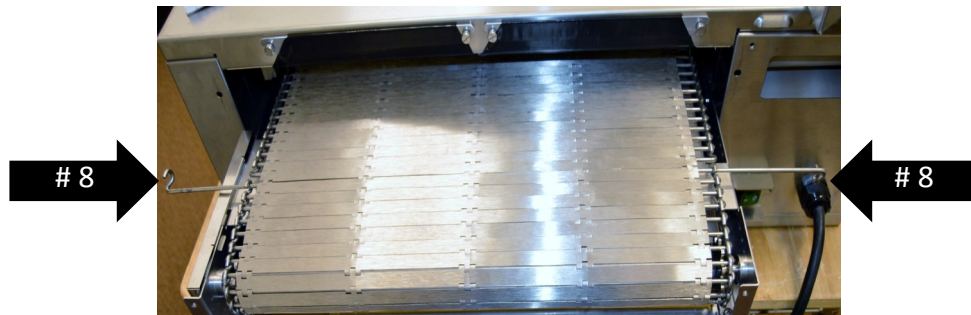

Remove/Replace Conveyor Belt (Cont..)

10 Feed in New Belt

11 Insert (2) linkages that were removed in step 8. (1 on each side of belt)

12 Use pliers to hook linkages onto belt

13 Slightly crimp the master link onto the belt

14 After ensuring the belt is secure, slide the conveyor assembly back into unit

15 Secure the front cover by installing the (4) screws previously removed in step 4.

16 Secure (2) belt tensioner bolts on rear side of unit, previously loosened in step 3.

17 Re-install the in-feed rack

18 Plug in Unit, ensure the unit is fully functional.

Horizontal Core Bun Toaster

CBT-SB-NA-1PS



Remove/Replace Teflon Bars

1 Unplug the unit

WARNING

Failure to disconnect power from the unit before servicing could result in severe bodily injury or death. The ON/OFF Switch does not disconnect incoming power to the unit.

2 Remove the In-Feed Rack

3 Release tension on the conveyor belt by loosening (2) screws on rear side of unit. Refer to the **Blue Arrows**

4 Remove the front cover by removing the (4) screws. Refer to the **Red Arrows**

5 Push in the release knob, then pull the conveyor assembly out

6 Find the master link on belt. Refer to the **Yellow Arrow**

7 Un-cripp the master linkage on both sides. Use pliers to remove. Refer to the **Green Arrows**.

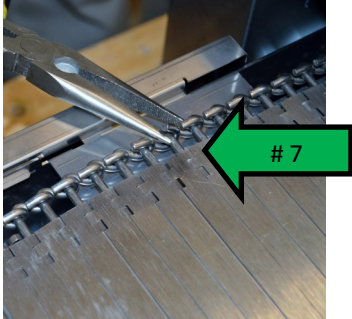
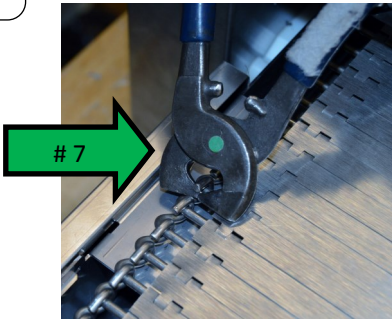
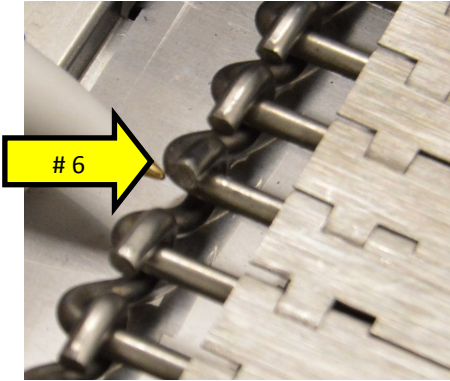
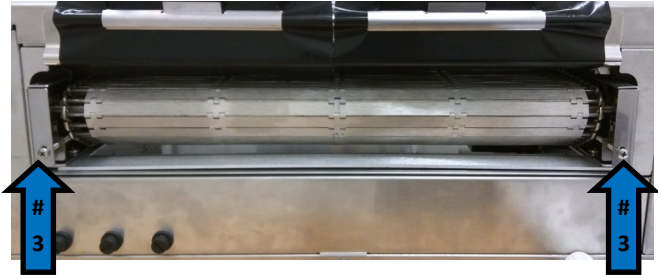

Remove/Replace Teflon Bars (Cont..)

8 Slide master links out from each side. Refer to the **Black Arrows**

9 Pull conveyor belt out. Refer to the **Orange Arrow**.

10 Remove (4) screws to release all (4) Teflon bars. Refer to the **Green Arrows**

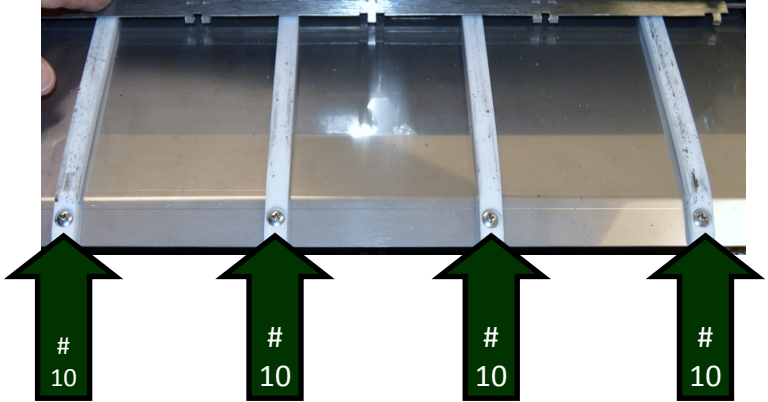
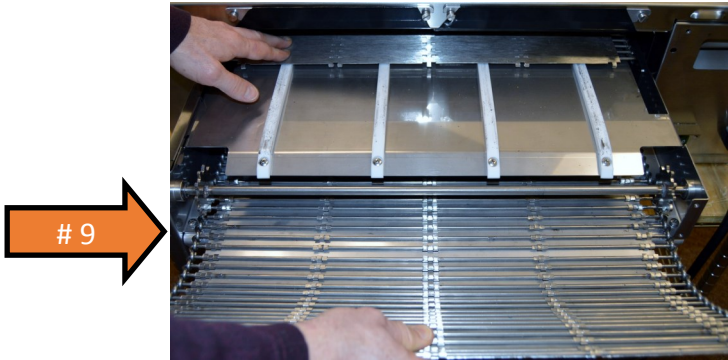
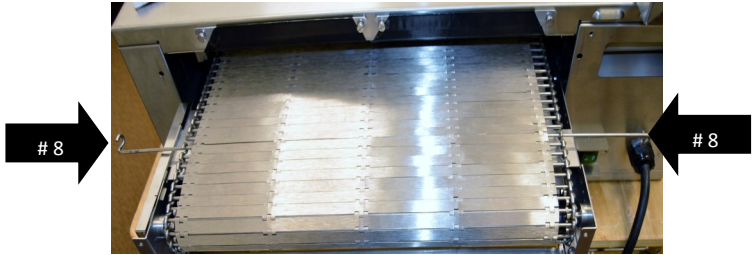

Remove/Replace Teflon Bars (Cont..)

11 Install (4) screws to secure (4) Teflon bars. Ensure the Teflon bars are properly aligned.

12 Feed in the Conveyor Belt

13 Insert (2) linkages that were removed in step 8. (1 on each side of belt)

14 Use pliers to hook linkages onto belt

15 Slightly crimp the master link onto the belt

16 After ensuring the belt is secure, slide the conveyor assembly back into unit

17 Secure the front cover by installing the (4) screws previously removed in step 4.

18 Secure (2) belt tensioner bolts on rear side of unit, previously loosened in step 3.

19 Re-install the in-feed rack

20 Plug in Unit, ensure the unit is fully functional.

Remove/Replace Motor and Belt Assembly

1 Unplug the unit



WARNING

Failure to disconnect power from the unit before servicing could result in severe bodily injury or death. The ON/OFF Switch does not disconnect incoming power to the unit.

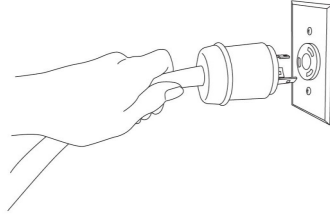

2 Remove the In-Feed Rack

3 Remove the front cover by removing the (4) screws

4 Push in the release knob, then pull the conveyor assembly out

5 On the left side of the conveyor assembly, remove the belt cover.

6 On the underside of the conveyor assembly, remove the motor cover by unhooking the 4 tabs.

7 Remove (4) 8mm nuts to remove motor, and release tension from belt.



Remove/Replace Motor and Belt Assembly (Cont...)

- 8** Reinstall Belt and Motor by securing the (4) 8mm nuts and (4) screws.
- 9** Reinstall the motor cover on the underside of the conveyor assembly
- 10** Reinstall the belt cover on the left side of the conveyor assembly
- 11** Slide electronics tray back into the unit.
- 12** Secure the front cover by installing the (4) screws previously removed in step 3.
- 13** Secure (2) belt tensioner bolts on rear side of unit.
- 14** Re-install the in-feed rack
- 15** Plug in Unit, ensure the unit is fully functional.

Remove/Replace Display Assembly

1 Unplug the unit



WARNING

Failure to disconnect power from the unit before servicing could result in severe bodily injury or death. The ON/OFF Switch does not disconnect incoming power to the unit.

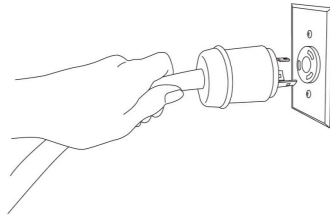

2 Remove the (2) Phillips screws to release the left side panel. Refer to the **Green Arrows**.

3 Unplug the Display Harness. Refer to the **Red Arrow**.

4 Remove the (4) M3 nuts. Lift the display assembly off the control side panel. Refer to the **Blue Arrows**.

5 Reinstall the display assembly by installing the (4) M3 nuts. Previously removed in step 4.

6 Plug in the display harness. Previously removed in step 3.

7 Secure the left side panel using the (2) Phillips screws, previously removed in step 2.

8 Plug in Unit, ensure the unit is fully functional.

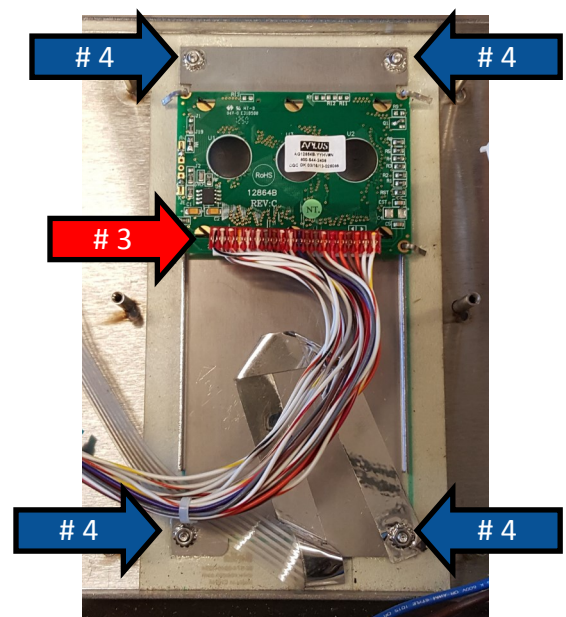

Remove/Replace Club Belt

1 Unplug the unit.



WARNING

Failure to disconnect power from the unit before servicing could result in severe bodily injury or death. The ON/OFF Switch does not disconnect incoming power to the unit.

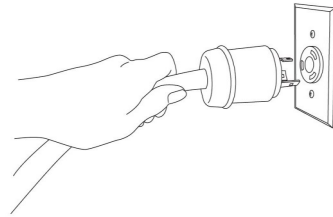

2 Refer to Page to remove club assembly.

3 Loosen (4) motor bolts to lessen tension from belt. Refer to the **Blue Arrows**.

4 Slide belt off gear assembly. Refer to the **Red Arrow**.

5 Replace Belt.

6 Tighten (4) motor bolts to apply tension to belt

7 Refer to Page to replace club assembly.

8 Plug in Unit, ensure the unit is fully functional.

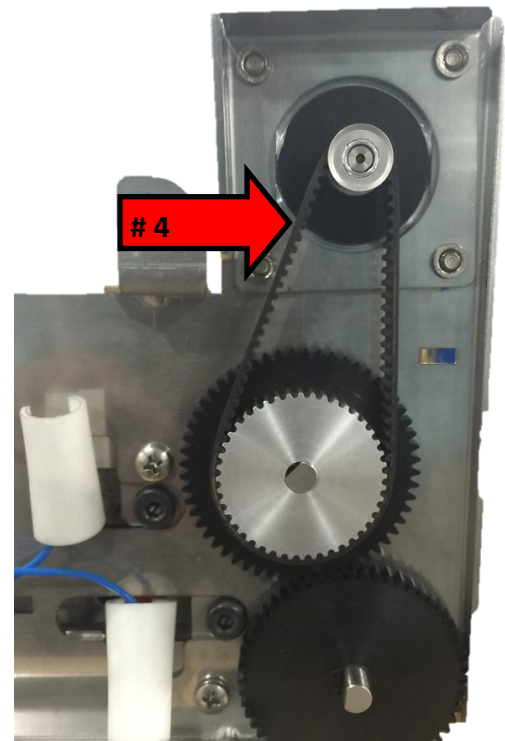
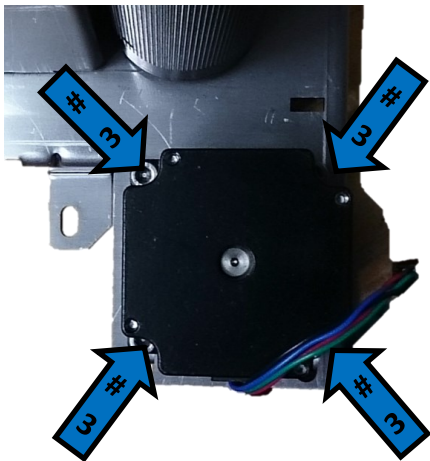

Remove/Replace Club Probe

1 Unplug the unit.



WARNING

Failure to disconnect power from the unit before servicing could result in severe bodily injury or death. The ON/OFF Switch does not disconnect incoming power to the unit.

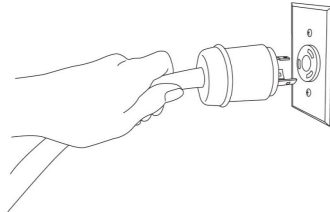

2 Refer to Page to remove club assembly and belt.

3 Remove (2) gears from club assembly. Refer to the **Red Arrows**.

4 Remove (3) Screws. Refer to the **Yellow Arrows**.

5 Remove (2) Wires by removing (2) Phillips screws. Refer to the **Orange Arrows**.

6 Pull out platen assembly.

7 Remove (4) side screws to remove platen from assembly. Note the length and position of screws. Refer to **Blue Arrows**.

8 Lift platen off assembly.

9 Remove Screw to remove probe from platen. Refer to the **Green Arrow**.

10 Replace Faulty Probe. Reuse sleeve for new probe.

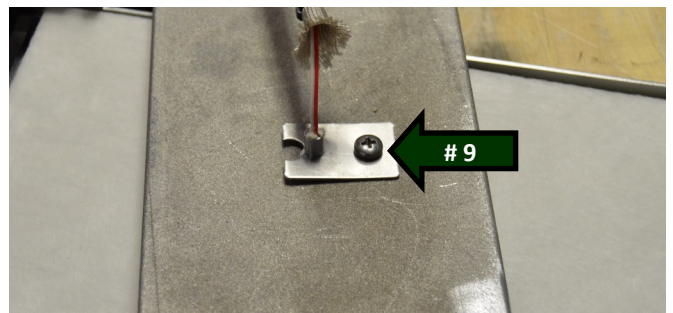
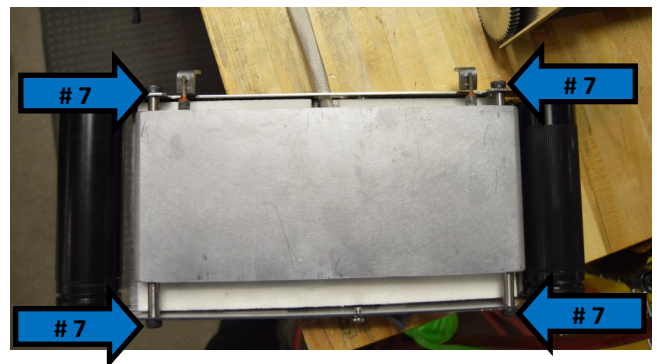
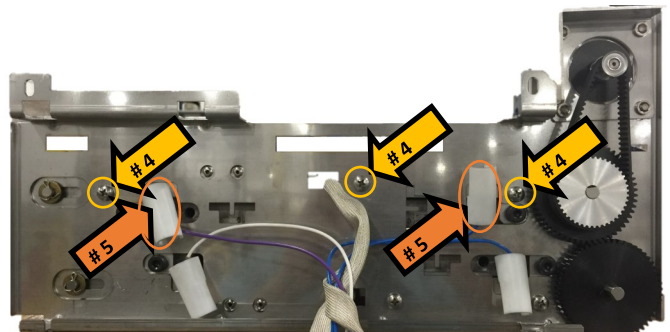
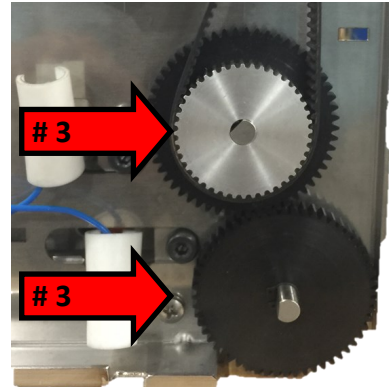

Remove/Replace Club Probe

11 After replacing the probe, reinstall screw to secure the probe to platen. Previously removed in Step 9.

12 Place platen back onto assembly. Previously removed in Step 8.

13 Replace (4) screws to secure platen to assembly. Previously removed in Step 7.

14 Feed probe wire through slot in assembly

15 Reinstall the conveyor platen assembly onto club assembly. Previously removed in Step 6.

16 Replace (2) wires, Previously removed in Step 5.

17 Replace (3) screws, Previously removed in Step 4.

18 Replace (2) gears, Previously removed in Step 3.

19 Tighten (4) motor bolts to apply tension to belt

20 Refer to Page to reassemble club assembly and belt.

Remove/Replace Club Assembly

1 Unplug the unit.

 **WARNING**

Failure to disconnect power from the unit before servicing could result in severe bodily injury or death. The ON/OFF Switch does not disconnect incoming power to the unit.

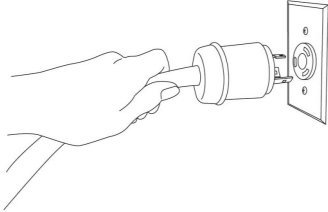

2 Push in from each side right side panel to remove panel from unit. Refer to the **Blue Arrows**

3 Remove (2) screws to release the bottom cover. Remove the bottom cover. Refer to the **Green Arrows**.

4 Remove (2) screws to release the club assembly. Refer to the **Red Arrows**

5 Slide the club assembly upwards, and out to remove the entire club assembly. Be cautious of any wiring.

6 Using a slotted screwdriver, remove the (4) screws to release all connections from the club assembly. Refer to the **Yellow Arrows**.

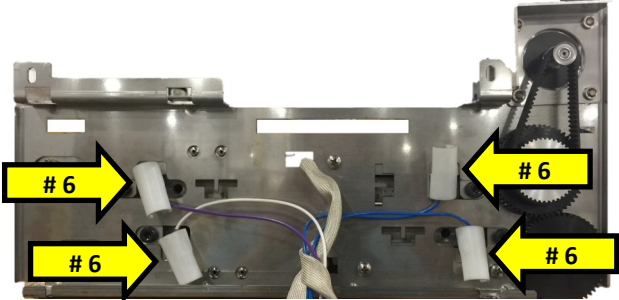
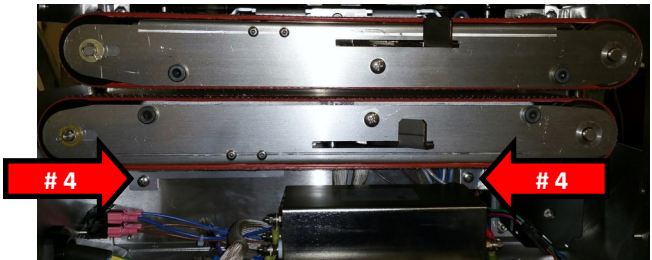

Remove/Replace Club Assembly

- 7** Using a slotted screwdriver, attach (4) wires to club assembly. Previously removed in step 6.
- 8** Slide club assembly back into unit. Make sure all tabs on the upper club assembly are aligned. Ensure all wiring is routed properly. Previously removed in step 5.
- 9** Install 2 screws to secure club assembly. Previously removed in step 4.
- 10** Re-install the cover, and (2) screws. Previously removed in step 3.
- 11** Re-install right side cover. Previously removed in step 2.
- 12** Plug in Unit, ensure the unit is fully functional.

Remove/Replace Platen High Limit Switch

1 Unplug the unit.

 **WARNING**

Failure to disconnect power from the unit before servicing could result in severe bodily injury or death. The ON/OFF Switch does not disconnect incoming power to the unit.

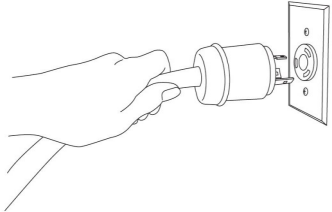

2 Push in from each side right side panel to remove panel from unit. Refer to the **Blue Arrows**

3 Remove (2) screws to release the bottom cover. Remove the bottom cover. Refer to the **Green Arrows**.

4 Remove (4) screws to release the club assembly and top cover. Refer to the **Red Arrows**

5 Slide the club assembly upwards, and out to remove the entire club assembly. Be cautious of any wiring.

6 Using a slotted screwdriver, remove the (4) screws to release all connections from the club assembly. Refer to the **Yellow Arrows**.

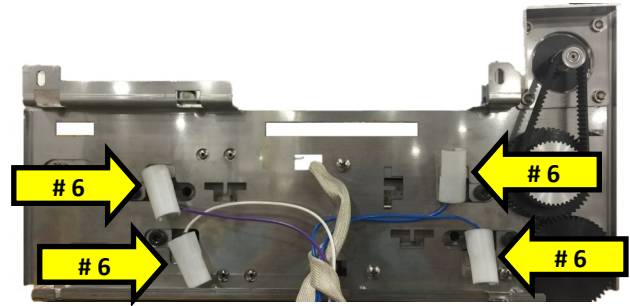

Remove/Replace Platen High Limit Switch (Continued)

7 Open the Left Side panel by loosening the (2) Phillips screws. Refer to the **Blue Arrows**.

8 Remove the (2) screws to release the top cover. Refer to the **Green Arrows**.

9 Lift top cover off the unit.

10 Remove (2) screws to remove High Limit Switch bracket and release the high limit switch. Refer to the **Orange Arrows**.

11 Loosen the bottom screw to access the electronics tray. Reference the **Red Arrow**.

12 Remove (2) nuts to remove High Limit Switch and pull the high limit switch out of the unit. Refer to the **Black Arrow**.

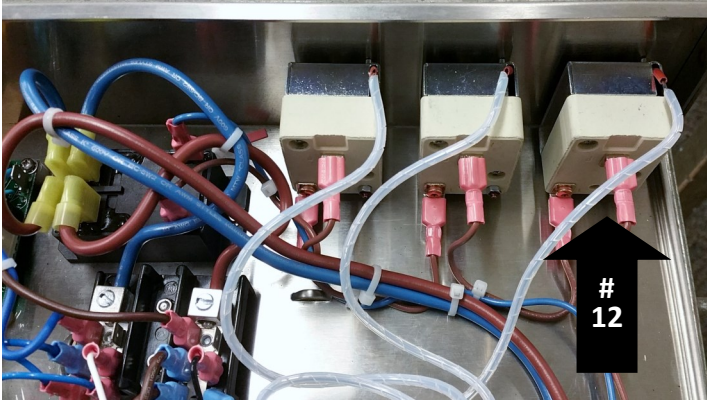
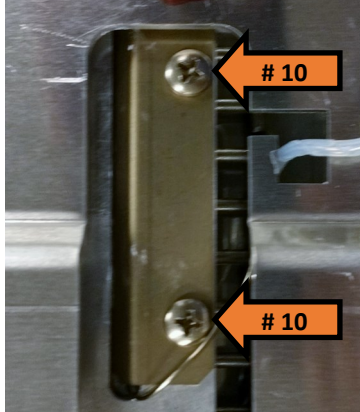
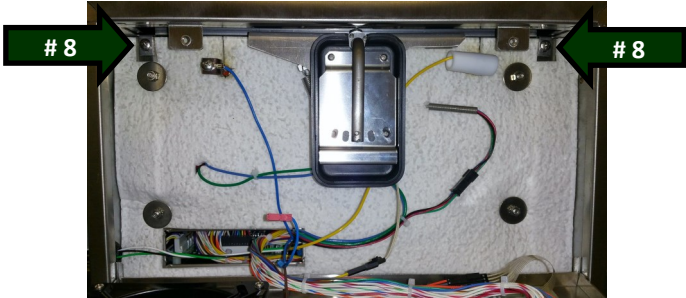

Remove/Replace Platen High Limit Switch

13 Reinstall the high limit switch. Previously removed in Step 12. Rewire high limit switch accordingly.

14 Close the electronics tray. Previously opened in Step 11.

15 Re-install the high limit switch bracket. Previously removed in Step 10.

16 Re-install top cover onto unit. Previously removed in Step 9.

17 Install the (2) Phillips screws on Left side of unit. Previously removed in Step 8.

18 Close the left side panel by tightening the (2) Phillips screws. Previously removed in Step 7.

19 Using a slotted screwdriver, reconnect all (4) connections on club assembly. Previously removed in Step 6.

20 Re-install the club assembly, previously removed in Step 5.

21 Re-install (4) Phillips screws to secure top cover and club assembly to unit. Previously removed in Step 4.

22 Re-install lower club cover. Previously removed in Step 3.

23 Re-install the right side panel. Previously removed in step 2.

24 Plug in Unit, ensure the unit is fully functional.

Allowable Labor Limits

Allowable Labor Limits		
<u>Procedure</u>	<u>Part Number</u>	<u>Max Labor Hours</u>
Remove/Replace PCB	353-262CS	0.5 Hours
Remove/Replace Relay	65-058S	0.5 Hours
Remove/Replace Conveyor Belt	353-300S	0.5 Hours
Remove/Replace Teflon Bars	353-442S	0.5 Hours
Remove/Replace Motor and Belt Assembly	353-241S & 353-357S	0.5 Hours
Remove/Replace Display Assembly	526-370S	0.5 Hours
Remove/Replace Club Belt	353-357S	1.0 Hours
Remove/Replace Club Probe	527-468S OR 527-467S	1.0 Hours
Remove/Replace Club Assembly (Top or Bottom)	353-231S OR 353-233S	1.0 Hours
Remove/Replace Main Platen High Limit Switch	526-281S	0.5 Hours