

# Operation Manual



DHB-CGB Series



DHB2PT-20CGB

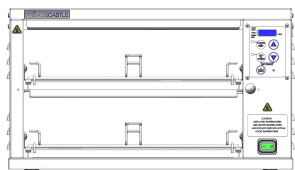

DHB2PT-20CGBN

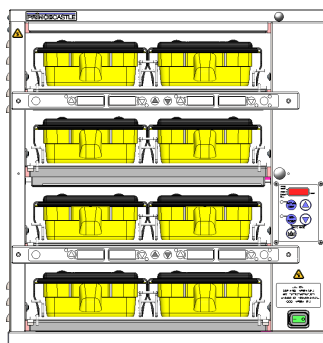

DHB4PT-20CGB  
DHB4SS-20CGB



DHB2PT-27CGB

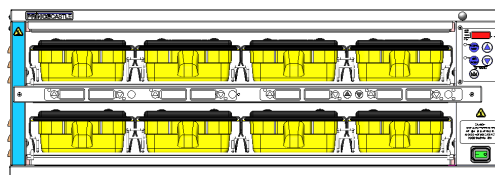

DHB2PT-33CGB; DHB2SS-33CGB



**ATTENTION:** Read the instructions before using the machine.

## LIMITED WARRANTY

This product is warranted to be free from defects in material and/or workmanship for a period of 1 years from date of original installation, not to exceed 18 months from the date of manufacture.

Any component which proves to be faulty in material and/or workmanship will be replaced or repaired (at the option of Prince Castle LLC) without cost to the customer for parts and labor. This warranty covers on location service (i.e. trip charges and or mileage). Travel mileage is limited to 100 miles (200 Kilometers) round trip (one trip warranty) from an authorized service agency or its sub-service agency. This warranty is subject to the following exceptions/conditions:

- Use of any non-genuine Prince Castle parts voids this warranty.
- All labor to be performed during regular work hours. Overtime premium (the incremental amount) will be charged to the customer.
- Damage caused by carelessness, neglect and/or abuse (e.g., dropping, tampering or altering parts, equipment damaged in shipment, by fire, flood or an act of nature) is not covered under this warranty.
- All problems due to operation at voltages other than that specified on equipment nameplates are not covered by this warranty. Conversion to correct voltage is the customer's responsibility.
- This equipment must be serviced by Prince Castle Authorized Service Agency or a Prince Castle Service Technician during the warranty period.

## TABLE OF CONTENTS

Model Specifications .....	2
Safety Information .....	2
Configurations .....	2
Product Identification .....	3
Installation .....	3
Operation .....	4
Cleaning.....	5
Setting the Temperature .....	6
Calibrating the Heaters / Selecting Day Parts .....	7
Changing the Hold and Cook More Times .....	8
Changing Product Names .....	9
Changing Temperature Scale .....	10
Default Menu and Temperature .....	11
Diagnostics .....	12
Wiring Diagrams .....	13
Parts List .....	14



355 EAST KEHOE BLVD. ~ CAROL STREAM, IL, 60188, USA  
PHONE: 630-462-8800 ~ TOLL FREE: 1-800-PCASTLE  
FAX 630-462-1460 ~ WWW.PRINCECASTLE.COM

**Model Specifications**

STYLE	MODEL NO.	VOLTAGE	AMPS	HERTZ
2H X 4W	DHB2PT/SS-33CGB	208-240	20 Max	50/60
4H X 2W	DHB4PT/SS-20CGB	208-240	20 Max	50/60
2H X 3W	DHB2PT-27CGB	208-240	20 Max	50/60
2H X 2W	DHB2PT/SS-20CGB	208-240	20 Max	50/60
2H X 2W	DHB2PT-20CGBN (No timer bars)	208-240	20 Max	50/60

**WARNING**



**WARNING**

Indicates information important to the proper operation of the unit. Failure to observe may result in damage to the equipment and/or severe bodily injury or death.



**CAUTION**

Indicates information important to the operation of the unit. Failure to observe may result in damage to the equipment.

**Important**

Prince Castle reserves the right to change specifications and product design without notice. Such revisions do not entitle the buyer to corresponding changes, improvements, additions or replacements for previously purchased equipment.

## Product Identification

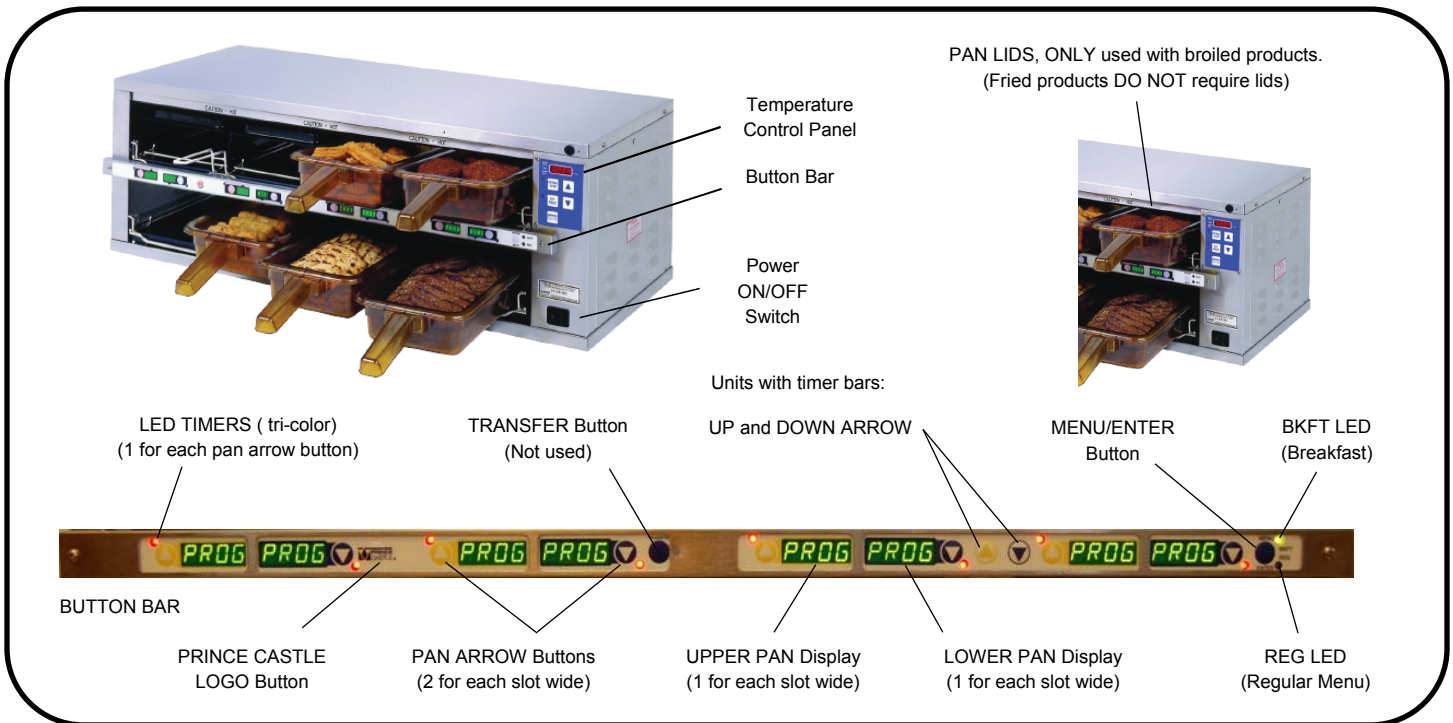

## Installation

1

Remove the unit from the carton and inspect for signs of damage. If there is damage to the unit:

- notify the carrier within 24 hours of delivery
- save carton and packaging materials for inspection purposes
- contact your local dealer, or if purchased directly, the Prince Castle Sales Department at 800-722-7853 or 1-630-462-8800 to arrange for a replacement unit.

**NOTE:** Plug the power cord into the proper electrical receptacle. All electrical connections must be in accordance with local electrical codes and any other applicable codes.

2

Place Holding Bin on flat surface.  
Remove blue and/or white protective covering.

**NOTE:** When installing this unit, the ambient temperature at the mounting site should not exceed 100°F (38°C)

3

Plug unit into a grounded receptacle with a matching plug configuration.

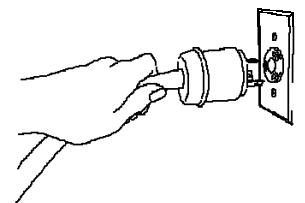

**WARNING:**

All electrical connections must be in accordance with local electrical codes and any other applicable codes. If the supply cord is damaged, it must be replaced by the manufacturer, its service agent, or similarly qualified persons in order to avoid a hazard. To prevent an electric shock hazard this device must be bonded to equipment in close proximity with an equipotential bonding conductor. This device is equipped with a grounding lug for this purpose.

**Operation**

**WARNING:** This application is not intended for use by persons (including children) with reduced physical, sensory or mental capabilities, or lack of experience and knowledge, unless they have been given supervision or instruction concerning use of the appliance by a person responsible for their safety.

**1** To turn on the unit,  
Turn Power On/Off switch (A) to **ON** position.



Allow 20 minutes for heaters to reach operating temperature. The button bar will read "WARM UP" as the unit warms up, they will display the product names.

**NOTE:** Load pan covers (if used) and insert pans into the

**2** Press all Pan Arrow buttons. Timer bar units only  
The Pan displays will show the assigned product name.



If no product is assigned, the display will be dim and show "----". Pressing the Pan Arrow button will not activate the timer if "----" is displayed. Pressing Pan Arrow button when product name is displayed will start timing cycle.

**BKFT** (Breakfast) or **REG** (Regular Menu) will be lit depending on pre-programmed menu.

**3** LED Timing Status Timer bar units only



**LED TIMERS**

- RED** (steady) = Ready for product
- RED** (flashing) = Discard product
- GREEN** (steady) = Oldest product, use first
- GREEN** (flashing) = Cook more product
- YELLOW** (steady) = Newer product, use green first
- YELLOW** (flashing) = Cook more product

**4** When **LED** is steady **RED**, load product and press the Pan Arrow button. Timer bar units only



If more than one pan is active for a product, the **LED** for the first pan loaded will turn from **RED** to **GREEN**.

If only one pan is active for a product, the **LED** will turn from **RED** to **GREEN**.

The **LED** for the 2nd pan loaded with the same product will turn from **RED** to **YELLOW**.

The **LED** timer can be stopped (cancelled) at any time by pressing and releasing the corresponding **PAN** Arrow button.

**5** When any of the timer **LED** flash, cook more product or remove and discard product as indicated. Timer bar units only

- GREEN** (flashing) = Cook more product
- YELLOW** (flashing) = Cook more product
- RED** (flashing) = Discard product

**WARNING:** HOT SURFACES

## Operation (continued)

**6** To change a menu selection for a specific pan cavity, use the following steps: Timer bar units only

A. Press and hold the **PRINCE CASTLE LOGO** button for 6 seconds. All Pan displays will show **PROG**. All LED Timers will be **RED**.

C. Press the **UP** or **DOWN** Arrow button to scroll to the desired menu item.

D. Press the **MENU/ENTER** button to select the menu item.



B. Press a Pan Arrow button to change the menu. The **LED** Timer will change to **YELLOW** and the display will change from **PROG** to the assigned menu item.

E. Repeat steps A – D as required for other Pan displays. Press the **PRINCE CASTLE LOGO** button to exit the Program Mode.

**NOTE:** A pan may be set as "not used" by assigning "- - -" as its product.

**7** To shut down the unit, turn the Power On/Off switch (A) to **OFF** position.



## Cleaning

**! WARNING:**

Before performing any maintenance, turn the power switch to the **OFF** position and unplug the power cord from the electrical receptacle.

**! CAUTION:**

This unit is not watertight. Do not clean with a water jet/jet spray. Do not immerse the unit in water.

1. Turn the unit off and unplug the power cord from electrical receptacle.
2. Remove the pans and covers. Wipe all parts and unit with a damp cloth. **DO NOT** use a green Scotch Bright pad cleaner, ice or water.

**Setting the Temperature**

- 1** The unit has two shelves, each with an upper and lower heater (four heaters total). All units  
 The factory pre-set for the upper heaters is 107°C (225°F)  
 The factory pre-set for the lower heaters is 90°C (195°F)  
 Use the control below and the following steps to set the setpoint temperature for each heater.

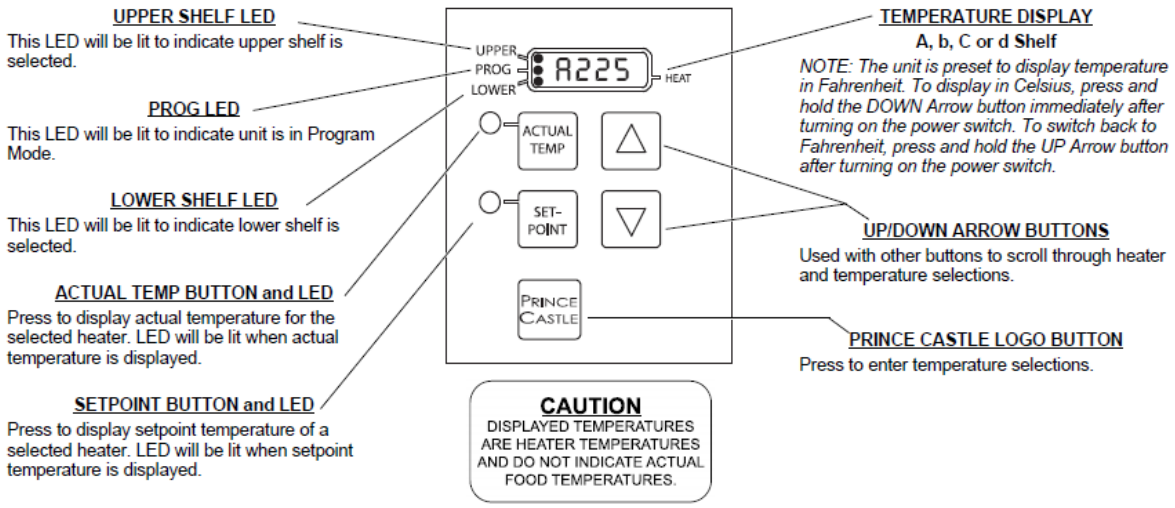

*NOTE: To reset all times and temperatures to the factory settings, turn the unit off, then press and hold the UP and DOWN Arrow buttons simultaneously while turning the unit back on. A "P" will appear in the display and all times and temperatures will be reset to original factory settings.*

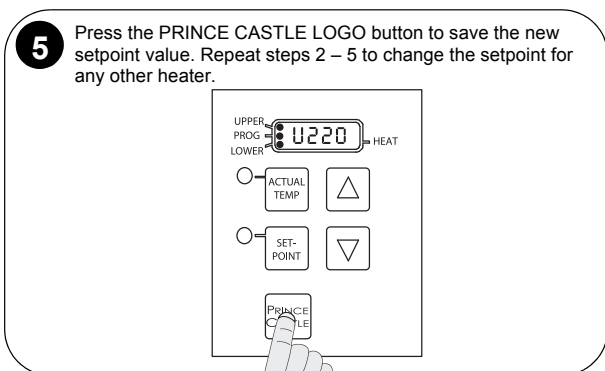
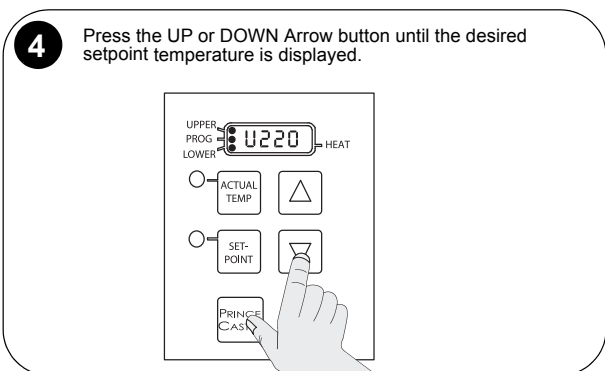
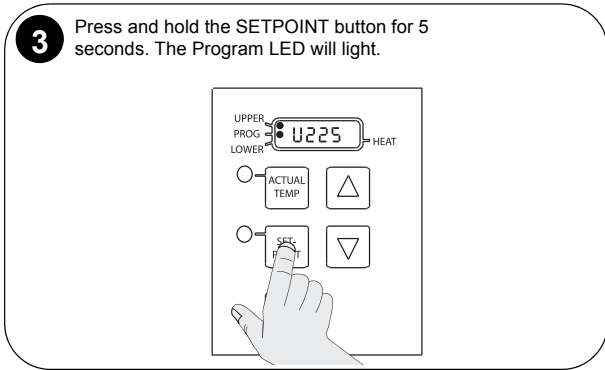
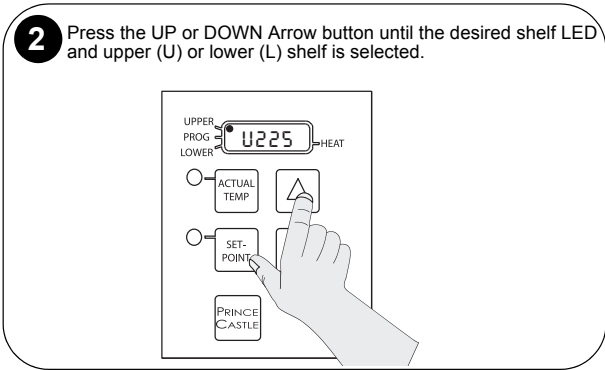

## Calibrating Heaters

**1** Use the following steps to calibrate the individual heaters

Press the **UP** or **DOWN** Arrow button until the desired shelf **LED** and upper or lower heater is selected.

**NOTE:** Allow sufficient amount of time for temperatures to stabilize before starting calibration. (approx. 30 mins.)

**4** Press the **UP** or **DOWN** Arrow button until the temperature displayed matches the reading obtained in Step 2. Press the **PRINCE CASTLE LOGO** button to save the temperature value and exit the Calibration Mode.

**2** Take a temperature reading within the shelf near the center of each heater surface.

**WARNING: HOT SURFACES**  
Use caution when taking temperature readings within the shelf.

**NOTE:** Use an independent Temperature meter

## Selecting Day Part

**3** Press and hold the **PRINCE CASTLE LOGO** and **ACTUAL TEMP** buttons for 5 seconds. The colon (:) LED indicator will light. The temperature displayed is the actual heater temperature sensed by the controller. To clear any offset readings, press the **SETPOINT** button.

**1** Press and hold the **SETPOINT** button and the **DOWN** Arrow button for 3 seconds to change Day Part to change the menu.

**NOTE:** The display will show **DAY #** if the daypart has been successfully changed.

**NOTE:** Whenever a bin is powered **ON** it defaults to **DAY PART 1** no matter what time of day it is.

**Changing the Hold and Cook-More Times**

**1** The **SET PRODUCT TIME** menu is used to change the Hold and Cook-More times. Press and hold the **PRINCE CASTLE LOGO** button, then immediately press and hold the **MENU/ENTER** button until the display shows one of six programming menus.



**2** Press and release the **MENU/ENTER** button to enter the Set Product Time menu. The display will show **BURG TIME** ↑↓ **ENTR**. Use the **UP** or **DOWN** Arrow button to scroll through the list of products. When the desired product is displayed, press the **MENU/ENTER** button to select it.



***NOTE:** Holding the **UP** or **DOWN** Arrow button for longer than 2 seconds will cause the product list to automatically scroll up or down.*

**3** The display will show **90** ↑↓ **ENTR**.



Use the **UP** or **DOWN** Arrow button to scroll to the desired Hold time. When the desired Hold time is displayed, press the **MENU/ENTER** button to save the desired Hold time.



***NOTE:** Hold time cannot be reduced to less than the Cook-More time plus one minute. **NOTE:** All times are displayed in minutes only. For example, 2 and half hours is displayed as 150*

**4** The display will show **COOK 03** ↑↓ **ENTR**.



Use the **UP** or **DOWN** Arrow button to scroll to the desired Cook-More time. When the desired Cook-More time is displayed, press the **MENU/ENTER** button to save it.



***NOTE:** Cook-More time cannot be increased to more than the Hold time, minus one minute.*

**5** The display will show **BURG TIME** ↑↓ **ENTR**. Repeat Steps 2 – 4 for any other product. Press and release the **PRINCE CASTLE LOGO** button at any time to exit the Program Mode and return to the Run Mode.

***NOTE:** If the **MENU/ENTER** button has not been pressed to save any changes, the program will revert to the original values.*



## Changing Product Names

- 1 The **EDIT PRODUCT NAME** menu is used to change a default product name to one of your own choosing. Press and hold the **PRINCE CASTLE LOGO** button, then immediately press and hold the **MENU/ENTER** button until the display shows one of six programming menus. Use the **UP** or **DOWN** Arrow button to scroll to the **PROD NAME** ↑ ↓ **ENTR** (Edit Product Name) menu.



*NOTE: The default menu items and names are listed on page 11.*

- 2 Press and release the **MENU/ENTER** button to enter the Edit Product Name menu. Use the **UP** or **DOWN** Arrow button to scroll through the list of products. When the desired product is displayed, press the **MENU/ENTER** button to select it. The first letter (in this case, the **B**) will start blinking.



- 3 To change the blinking **B**, use the **UP** or **DOWN** Arrow button to scroll to the desired letter/number/symbol. When the desired selection is displayed, press the **PAN** Arrow button to move to the next digit. Repeat for all digits.



*NOTE: Holding the UP or DOWN Arrow button for longer than 2 seconds will cause the display to automatically*

- 4 When all four digits have been changed, press the **MENU/ENTER** button to select the new name.



- 5 The display will show **PROD NAME** ↑ ↓ **ENTR**. Repeat Steps 2 – 4 for any other product. Press and release the **PRINCE CASTLE LOGO** button at any time to exit the Program Mode and return to the Run Mode.



*NOTE: If the MENU/ENTER button has not been pressed to save any changes, the program will revert to the original names.*

**Changing Temperature Scale to Celsius**

**1** Use the following steps to adjust the temperature scale to Celsius

To shut down the unit,  
 turn the Power On/Off switch (A) to **OFF** position.



(A)

**2** Press and hold the DOWN button and turn the power ON/OFF switch (A) to the ON position until 'C' is flashed on the display, then release.

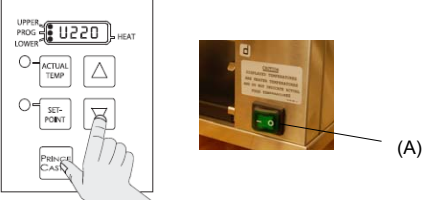

(A)

**Changing Temperature Scale to Fahrenheit**

**1** Use the following steps to adjust the temperature scale to Fahrenheit

To shut down the unit,  
 turn the Power On/Off switch (A) to **OFF** position.



(A)

**2** Press and hold the UP button and turn the power ON/OFF switch (A) to the ON position until 'F' is flashed on the display, then release.

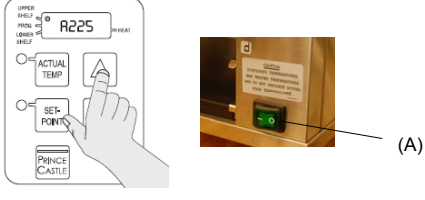

(A)

**Default Menu Items**

**PRODUCTS**

DHB2SS-33CGB Default Settings:

Menu 1:	HAM	SAUS	EGGS	EGGS
	BACN	SAUS	EGGS	EGGS
Menu 2:	BGR1	BGR1	BGR2	BGR2
	BGR1	BGR1	BGR2	BGR2
Menu 3:	CHX1	CHX2	CHX3	WING
	CHX1	CHX2	CHX3	FISH
Menu 4:	CHX1	WING	MOZ	POP
	CHX2	WING	MOZ	POP
Menu 5:	CHX1	CHX3	WING	ORNG
	CHX2	WING	POP	MUSH
Menu 6:	EGGS	EGGS	HAM	SAUS
	EGGS	EGGS	BACN	SAUS

DHB4SS-20CGB Default Settings:

Menu 1:	HAM	SAUS
	BACN	EGGS
	HAM	SAUS
	BACN	EGGS
Menu 2:	BGR1	BGR2
	BGR1	BGR2
	BGR1	BGR2
	BGR1	BGR2
Menu 3:	CHX1	CHX3
	CHX2	WING
	CHX1	CHX3
	CHX2	WING
Menu 4:	FISH	POP
	MOZ	MUSH
	FISH	POP
	MOZ	MUSH
Menu 5:	POP	ORNG
	MOZ	MUSH
	POP	ORNG
	MOZ	MUSH
Menu 6:	EGGS	BACN
	HAM	SAUS
	EGGS	BACN
	HAM	SAUS

Product Name	Hold Time	Cook Time
BGR1	30	3
BGR2	30	3
CHX1	30	3
CHX2	30	3
CHX3	30	3
WING	30	3
FISH	20	4
EGGS	30	3
SAUS	30	3
BACN	30	3
HAM	30	3
POP	30	3
MOZ	30	3
ORNG	10	3
MUSH	30	3
NUGG	30	3
SPCY	30	4
TOST	10	2
STRS	30	3
LRGE	20	3
SIX	20	3
BBQ	20	3
CRSP	30	4
STRP	20	4
SPC1	30	3

**Default Temperatures by Zone (per Day Part)**

2X4  
DHB2SS-33CGB

Day Part 1

UPPER HEATER 107°C (225°F)
pan   pan   pan   pan
LOWER HEATER 90°C (195°F)
UPPER HEATER 107°C (225°F)
pan   pan   pan   pan
LOWER HEATER 90°C (195°F)

Day Part 2

UPPER HEATER 110°C (230°F)
pan   pan   pan   pan
LOWER HEATER 98°C (210°F)
UPPER HEATER 110°C (230°F)
pan   pan   pan   pan
LOWER HEATER 98°C (210°F)

4X2  
DHB4SS-20CGB

Day Part 1

UPPER HEATER 107°C (225°F)
pan   pan
LOWER HEATER 90°C (195°F)
UPPER HEATER 107°C (225°F)
pan   pan
LOWER HEATER 90°C (195°F)
UPPER HEATER 107°C (225°F)
pan   pan
LOWER HEATER 90°C (195°F)
UPPER HEATER 107°C (225°F)
pan   pan
LOWER HEATER 90°C (195°F)

Day Part 2

UPPER HEATER 110°C (230°F)
pan   pan
LOWER HEATER 98°C (210°F)
UPPER HEATER 110°C (230°F)
pan   pan
LOWER HEATER 98°C (210°F)
UPPER HEATER 110°C (230°F)
pan   pan
LOWER HEATER 98°C (210°F)
UPPER HEATER 110°C (230°F)
pan   pan
LOWER HEATER 98°C (210°F)

**Troubleshooting**

 **WARNING:** To avoid personal injury and possible damage to the unit, troubleshooting and repair of electrical equipment should be performed by qualified service personnel. This unit should be unplugged when servicing. Except when electrical tests are required. Use extreme caution during electrical circuit tests as live circuits may be exposed.

<b>Problem</b>	<b>Probable Cause</b>	<b>Solution</b>
No Power	Power switch is turned off, Power cord is not plugged in.	Turn power switch to ON position, Ensure power cord is connected to proper receptacle
Unit will not heat up	Wrong power cord, loose connection on power switch and/or heater	<b>CALL TECH SUPPORT</b>  <b>1-800-462-8800</b>
Unit heats up but timer bars do not work	Timer bar wiring disconnected, timer bar is defective	<b>CALL TECH SUPPORT</b>  <b>1-800-462-8800</b>
Unit under/over heats	Check temperature settings Check temperature scale	<b>CALL TECH SUPPORT</b>  <b>1-800-462-8800</b>
Display flashes <b>OPN</b> and <b>REL</b>	Open relay, circuit or heater inoperable	<b>CALL TECH SUPPORT</b>  <b>1-800-462-8800</b>
Display flashes <b>SHR</b> and <b>REL</b>	Shorted relay, circuit inoperable, open heater, unplugged ribbon cable	<b>CALL TECH SUPPORT</b>  <b>1-800-462-8800</b>
Display shows <b>HHH</b> for extended period and heat- er surface temperature is hot	Temperature is above 300 F (149 C), Abnormal operation	<b>CALL TECH SUPPORT</b>  <b>1-800-462-8800</b>

For all technical support, please contact **PRINCE CASTLE LLC 1-800-462-8800**  
 For technical support worldwide, contact your local service representative / installer.

**Wiring Diagrams**

2X4  
 DHB2SS-33CGB

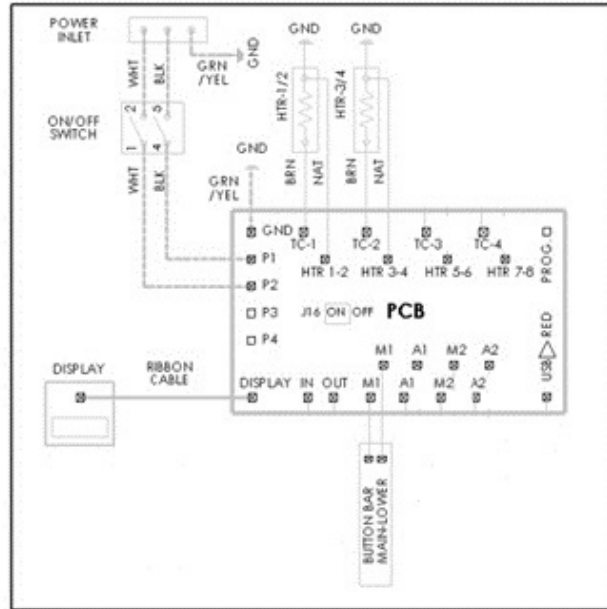

4X2  
 DHB4SS-20CGB

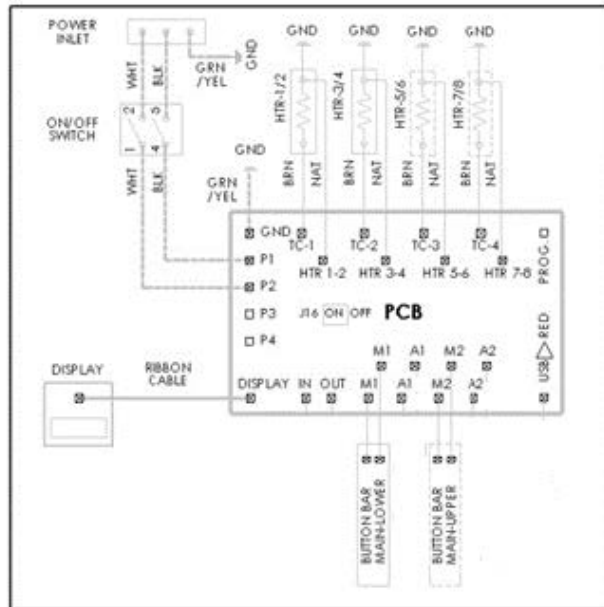

**Service Parts List**

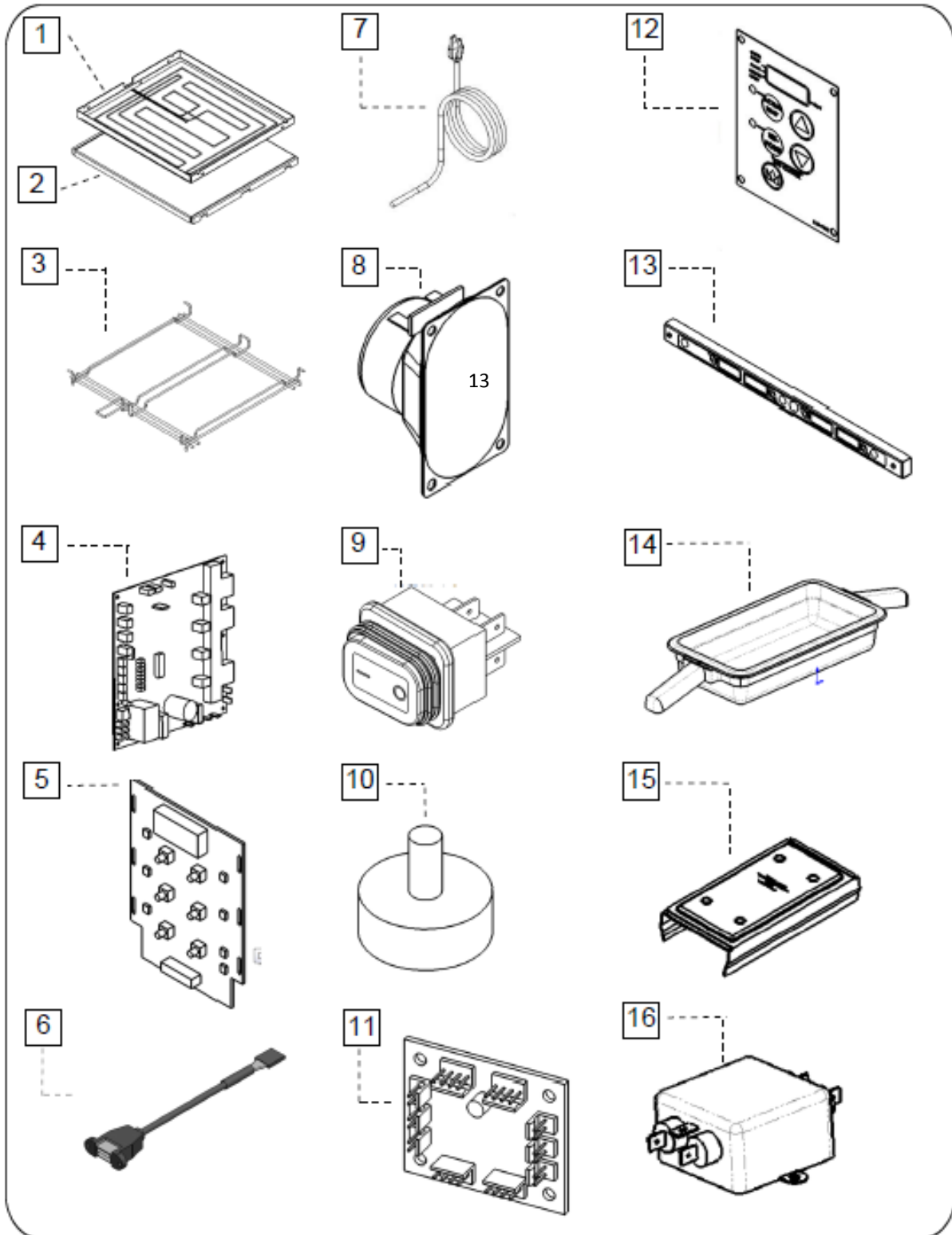

**Part Kit List**

<b>Ref</b>	<b>Part No</b>	<b>Description</b>
1	542-435S	Kit, Upper Heater Assy ( <b>DHB2PT/2SS-33CGB</b> )
	542-426S	Kit, Upper Heater Assy ( <b>DHB2PT-27CGB</b> )
	542-419S	Kit, Upper Heater Assy ( <b>DHB2PT/4PT/4SS-20CGB</b> )
2	542-430S	Kit, Lower Heater Assy ( <b>DHB2PT/2SS-33CGB</b> )
	542-416S	Kit, Lower Heater Assy ( <b>DHB2PT/27CGB</b> )
	542-412S	Kit, Lower Heater Assy ( <b>DHB2PT/4PT/4SS-20CGB</b> )
3	541-636S	Kit, Rack Guide ( <b>DHB2PT/2SS-33CGB</b> )
	541-724S	Kit, Rack Guide ( <b>DHB2PT-27CGB</b> )
	541-169S	Kit, Rack Guide ( <b>DHB2PT/4PT/4SS-20CGB</b> )
4	541-735S	Kit, Main PCB ( <b>DHB2PT/2SS-33CGB</b> )
	541-734S	Kit, Main PCB ( <b>DHB2PT-27CGB</b> )
	541-733S	Kit, Main PCB ( <b>DHB2PT-20CGB</b> )
	541-802S	Kit, Main PCB ( <b>DHB4PT/4SS-20CGB</b> )
	541-1733S	Kit, Main PCB ( <b>DHB2PT-20CGBN</b> )
5	541-719S	Kit, Display PCB
6	95-1819S	Kit, USB
7	72-526S	Kit, Power Cord
8	88-709-2-11S	Kit, Speaker
9	78-219S	Kit Power Switch
10	197-232S	Kit, Foot Mounting
11	541-959S	Kit, PCB Audio Interface
12	541-1202S	Kit, Display Overlay
13	541-1534S	Kit, Main Timer Bar ( <b>DHB2PT/2SS-33CGB</b> )
	541-1533S	Kit, Main Timer Bar ( <b>DHB2PT-27CGB</b> )
	541-1531S	Kit, Main Timer Bar ( <b>DHB2PT/4PT/4SS-20CGB</b> )
14	541-442S	Kit, Pan ( <b>ALL DHB WITH PT</b> )
	541-1095S	Kit, Pan ( <b>ALL DHB WITH SS</b> )
15	541-723E16S	Kit, Cover
16	88-826S	Kit, Filter EMI 20A