



**PFA SERIES
FULLY AUTOMATIC FRYERS
INSTALLATION - INSPECTION - MAINTENANCE**



Be sure ALL operators read, understand and have access to this manual at all times.

PERFECT FRY

www.perfectfry.com

42 Allen Martin Drive, Essex Junction, Vermont 05452 USA Telephone: (802) 658-6600 Fax: (802) 864-0183

PN 84091 Rev I (6/25)

© 2025 - Perfect Fry Company

TABLE OF CONTENTS

Thank you for Purchasing a PFA Automatic Fryer from Perfect Fry!	3
Internet Connection	4
Owner's Responsibilities	5
Regulations & Recycling	6
SAFETY FIRST	7
INSTALLATION	8
Electrical Power Supply (North American Models)	8
Accessory Outlets (North American Models)	9
OVERVIEW	9
Prepare Countertop Area	10
Unpack	10
ASSEMBLY PROCESS	12
CLEANING	15
Daily Maintenance	15
Weekly Maintenance	15
Periodic Maintenance	17
OPERATING INSTRUCTIONS	18
Tips on Deep Frying	18
Oil Facts	19
Starting Up	22
Manual Mode Frying	23
Recipe Mode Frying	25
Rapid Fry	28
Dual Load	29
Canceling a Recipe	30
Standby Mode	31
Shut Down / Cool Down Operations	31
Edit a Recipe	32
Edit Recipe Groups	35
Settings	37
Optional Perfect Filter	40
MAINTENANCE	42
Error Faults & Troubleshooting	42
Troubleshooting Main Fan	43
Troubleshooting Control Fan	43
Troubleshooting Basket Motor	44
Troubleshooting Drawer Motor	44
Troubleshooting Other	45
PFS AUTOMATIC EXTINGUISHER	46
ORIGINAL STANDARD EQUIPMENT LIMITED WARRANTY	48

THANK YOU FOR PURCHASING A PFA AUTOMATIC FRYER FROM PERFECT FRY!

WARRANTY REGISTRATION

Be sure ALL operators read, understand and have access to this manual at all times.

1. Fill out the online warranty registration form anytime at www.perfectfry.com.

Now that you have registered your fryer;

- Take comfort in knowing that the management and staff at Perfect Fry Company are dedicated to ensure that you, the owner and operator of a Perfect Fry unit, receive a top quality product that is thoroughly inspected and tested prior to shipment.
- Take comfort in knowing that our local Authorized Service and Parts Distribution (ASAPD) network is committed to supplying your service and warranty needs. Each ASAPD has dedicated service staff that is able to answer any questions you may have regarding the operation of your Perfect Fry unit. We also have an online knowledgebase available 24/7/365 at perfectfry.com with many great tips and solutions.

OPEN KITCHEN REGISTRATION

1. Assemble unit fully (see “Installation”).
2. Scan code provided on removable label (shown below).
3. Follow steps provided by landing page & enter information as prompted to register unit online.

Connect **With** **OPEN KITCHEN**



GET STARTED TODAY!
bit.ly/PerfectFry-OpenKitchen

PLEASE REMOVE LABEL BEFORE OPERATION

INTERNET CONNECTION

Connecting with SAP

Perfect Fry Units are each supplied with a Secure Access Point (SAP). If the SAP is installed with a ethernet connection to the local network on the port featuring a Globe (left most position when viewing SAP from rear) it will automatically pair with the unit's ConnectWare module. To ensure signal strength the SAP should be installed within line of sight of the unit.

Connecting through a local Wi-Fi network

To bypass the use of the SAP and connect directly to the local network, use the following procedure.

1. From the main menu select More
2. Select Settings
3. Enter Manager passcode (1234 default)
4. Select Wi-Fi settings
5. Fill in SSID and Passkey
6. Save
7. Reboot as prompted

Checking Internet Connection

To check the connection status of your PerfectFry select the ? in the bottom right hand corner of the home screen, to enter the system information screen.

From the system information screen, select the Wi-Fi symbol in the bottom right-hand corner of the screen.

You can now view the connection status of your device in the **Cloud Status** screen.

Ensure your secure access point (SAP) device is powered and has a valid ethernet connection to the internet on the port labeled with a globe. The Connectware module at the rear of your unit will automatically pair with this device.

If you are having issues with your device's connection, email support@powerhousedynamics.com for further information.



OWNER'S RESPONSIBILITIES





IT IS THE OWNER'S RESPONSIBILITY TO:

- Ensure the Perfect Fry unit is properly maintained.
- Allow only properly trained personnel to operate, clean and maintain a Perfect Fry unit.
- Contact local authorities having jurisdiction to insure that the installation conforms to all local fire, building and health regulations.
- Schedule and maintain documentation that the appropriate inspection and maintenance of the PFS Automatic Extinguisher has been completed.
- Ensure that the model ready for installation matches the supply voltage.
- Ensure that the main power supply is disconnected before the Perfect Fry unit is serviced.
- Ensure that all safety devices are intact.
- Ensure that a proper surface is provided for the Perfect Fry unit to sit on.
- Ensure that proper clearances are kept.
- Operate and store the Perfect Fry unit above 32°F (0°C).
- Return the Perfect Fry unit for recycling when it reaches end of life.

REGULATIONS & RECYCLING

Installation of your Perfect Fry unit must conform to all local fire and health regulations and building codes. The installation, use, and maintenance is to be in accordance with the Standard for Ventilation Control and Fire Protection of Commercial Cooking Operations, NFPA 96 - 2004.

The table below describes the standards that your Perfect Fry unit has been tested to and the corresponding listing marks depending on your region.

STANDARD	DESCRIPTION	LISTING MARK
UL 197 UL 710B	Commercial electric cooking appliances. Commercial electric cooking appliances with recirculating systems. UL 197 & UL 710B reference the following standards which your Perfect Fry unit meets applicable parts thereof:	
	<ul style="list-style-type: none"> • UL 1046: Grease Filters for Exhaust Ducts. • UL 300: Fire Testing of Fire Extinguishing Systems for Protection of Restaurant Cooking Areas. • NFPA 17A: Wet Chemical Extinguishing Systems. • NFPA 96: Standard for Ventilation Control and Fire Protection of Commercial Cooking Operations. • EPA 202: Determination of Condensable Particulate Emissions for Stationary Sources. 	
CSA 22.2 #109	Commercial Cooking Appliances forming part of Canadian Electrical Code, Part 2 Safety Standards for Electrical Equipment.	
NSF 4	Commercial Cooking, Rethermalization, and Powered Hot Food Holding and Transport Equipment.	
EN60335-1	Safety of Household and Similar Electrical Appliances Part 1. General Requirements	
EN60335-2-37	Safety of Household and Similar Electrical Appliances Part 2. Commercial Electric Deep Fat Fryers	
EN55014-1 EN55014-2	Electromagnetic Compatibility (EMC) – Emissions & Immunity for Light Industrial Environments	
UL 900	Standard for Safety Air Filter Units	

A compiled “Approvals Documentation” file is available for download at www.perfectfry.com under the Resources, Literature tab.

SAFETY FIRST



LIFTING & MOVING:

- Your fryer's gross shipping weight is 159 lb. (72.12 kg). Net weight = 134 lb. (60.78 kg). **DO NOT LIFT THE FRYER BY YOURSELF. ALWAYS REMOVE OIL BEFORE MOVING FRYER.**

DEEP FRYING:

- Cooking oil is very hot ~350°F (177°C). Hot oil can cause severe burns. **DO NOT TOUCH THE COOKING OIL UNLESS YOU ARE SURE IT HAS COOLED.**

CLEANING:

- **DO NOT OPEN DRAWER LID OR FRONT PANEL WHEN PRODUCT IS LOADING**
- Before cleaning fryer or removing oil, let fryer cool to 122°F (50°C). **DO NOT TOUCH HEATER MODULE, VAT OR OIL UNLESS YOU ARE SURE IT HAS COOLED.**

COOKING OIL MAINTENANCE:

- For sanitation and safety, we recommend that the cooking oil is replaced once a week, more often for higher volume usage. Use a commercial grade deep-fryer formulated cooking oil. See Oil Facts on page 19.

SERVICING:

- **DISCONNECT THE POWER SOURCE BEFORE SERVICING THE FRYER.** There is no need to unplug your Perfect Fry unit for normal cleaning or maintenance.

STORAGE:

- Do not store your fryer below 32°F (0°C)
- Intended for indoor use only

INSTALLATION

ELECTRICAL POWER SUPPLY (NORTH AMERICAN MODELS)

- Your PERFECT FRY PFA must be connected to a dedicated electrical circuit that meets your fryer's requirements (see table below).



CAUTION Improper installation may damage the fryer and void your warranty.

- All electrical connections to comply with local and national standards and codes.
- If your fryer's plug does not fit your wall outlet receptacle, have an electrician install the appropriate NEMA receptacle within 4 feet of the fryer.
- See the manufacturer's label on your fryer for the electrical specifications.

MODEL	VAC	KW	KW W/OPTIONAL HEAT LAMP	CYCLE	PHASE	AMP	AMP W/OPTIONAL HEAT LAMP	NEMA
PFA500	208	5.0	5.4	60	1	24	26	6-30P
					3	14	15	15-30P
PFA730		7.3	7.7	60	1	35	37	6-50P
					3	21	22	15-30P
PFA500	240	5.5	5.9	50/60	1	23	25	6-30P
					3	14	15	15-30P
PFA730		8.0	8.4	50/60	1	34	35	6-50P
					3	20	21	15-30P
PFA500	200	4.7	5.1	50/60	1	24	26	6-30P
PFA730		6.8	7.2		1	34	36	6-50P
PFA500	220	4.6	5.0	50/60	1	21	23	6-30P
PFA730		6.7	7.1		1	31	33	6-50P
PFA500	230	5.0	5.4	50/60	1	22	24	6-30P
PFA730		7.3	7.7		1	32	34	6-50P
PFA500	220/380	4.6	5.0	50/60	3	7	8	*
PFA730		6.7	7.1		3	11	11	*
PFA500	230/400	5.0	5.4	50/60	3	8	8	*
PFA730		7.3	7.7		3	11	12	*
PFA500	240/415	5.5	5.9	50/60	3	8	9	*
PFA730		8.0	8.4		3	12	12	*

* No plug supplied. 1 Phase: Cord only | 3 Phase: No cord or plug

ACCESSORY OUTLETS (NORTH AMERICAN MODELS)

Your PFA is equipped with 1 heat lamp outlet (North American models only) that can accept a Perfect Fry approved heat lamp only. The front heat lamp for the PFA is rated at 400W (240V/2A).

CAUTION

Disconnect the fryer from the electrical supply before attempting the installation of any Perfect Fry heat lamp. The heat lamp is for use only on Perfect Fry equipment equipped and marked with a heat lamp outlet.

A FRONT PANEL MOUNT SWITCH CONTROLS THE POWER TO THE HEAT LAMP.

OVERVIEW

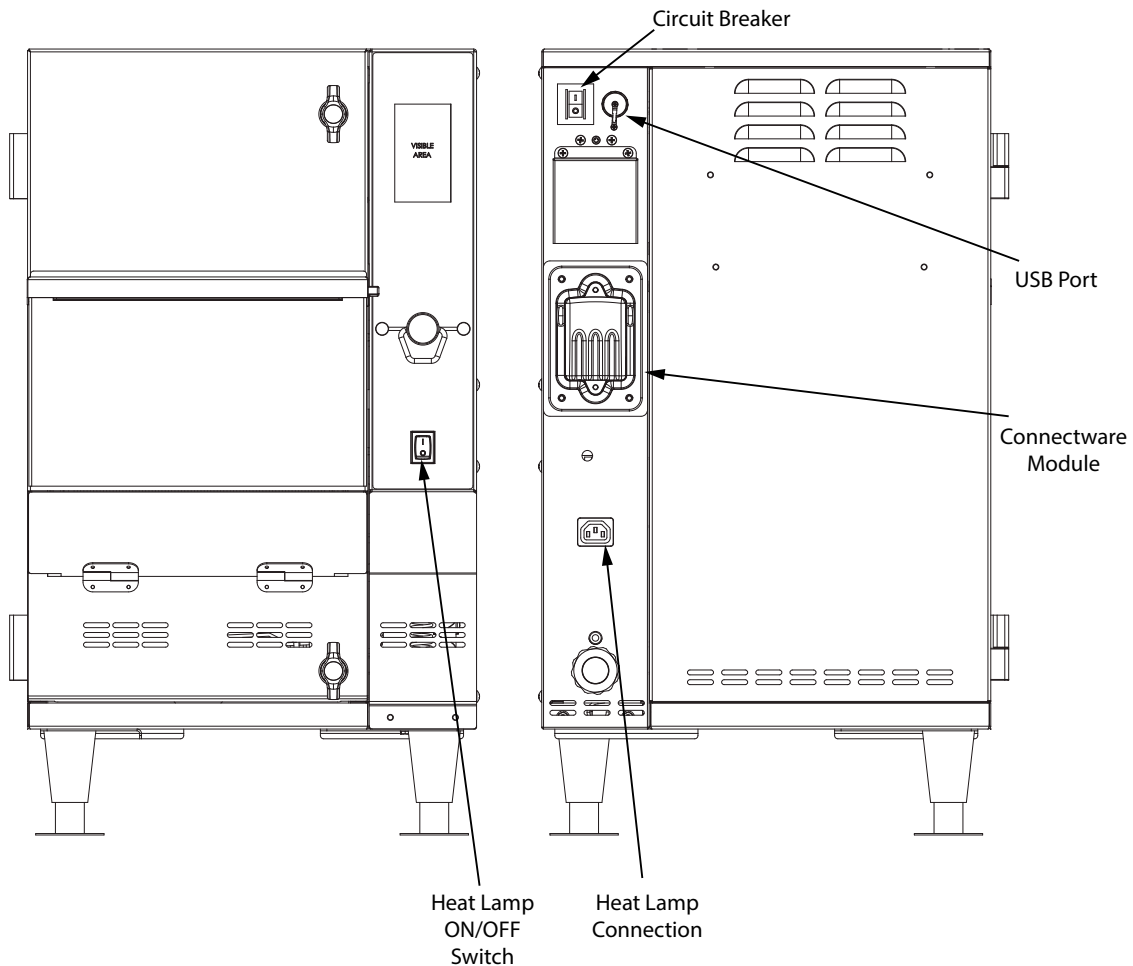

PREPARE COUNTERTOP AREA

Clear space for your PFA fryer on the counter. Refer to the following figure for product and clearance requirement dimensions.

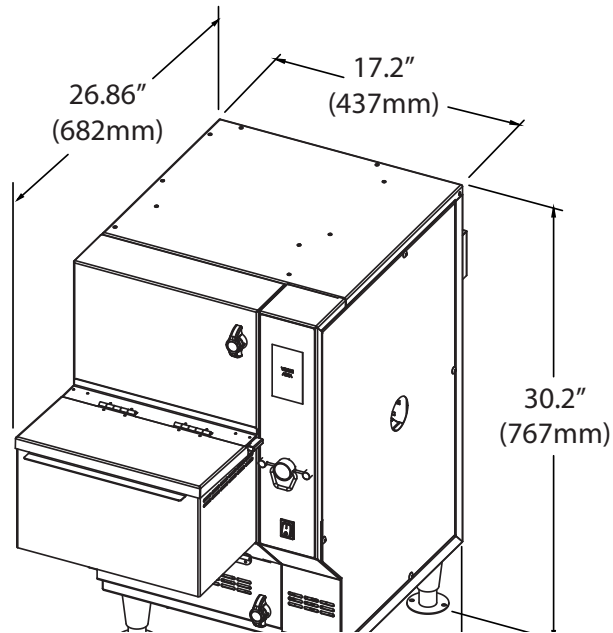

UNPACK

1. Cut straps on shipping box.
2. Remove box top and body
3. Remove outer plastic wrapping and keep box along with foam corners and sides
4. Remove all foam stuffing and parts
5. Remove protective vinyl

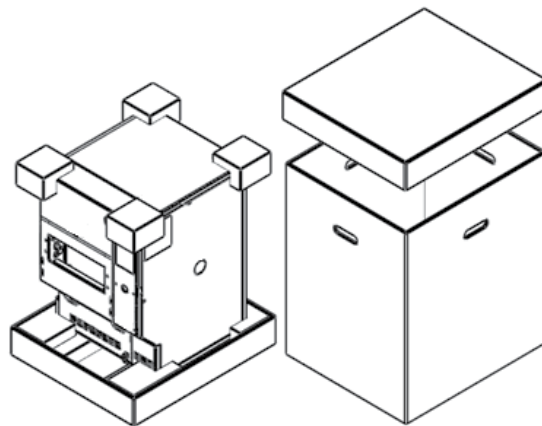



6. Put check mark in the box once the part is removed

- 1** Drawer Lid Assembly
- 2** Drawer Sleeve
- 3** Drain Hose
- 4** Shovel Assembly
- 5** Basket
- 6** Heat Lamp (optional)
- 7** Feet

ASSEMBLY PROCESS

CAUTION

Your PERFECT FRY weights 134 lbs (60.78 kg). Lift it carefully with your legs or with the help of another person and place it in its final location.

1. **Feet:** Attach the four feet to fryer base. The feet **MUST** be installed.



2. **Drawer Sleeve:** Install Drawer Sleeve by placing hooks into slots on face of door.



3. **Heat Lamp Option Only:** Install Heat Lamp below Drawer Sleeve. Plug in heat lamp power cable to Heat Lamp on left side and route cable to rear of fryer and plug into rear receptacle of fryer.



4. **Shovel Assembly:**

- a. Open the door and install the Shovel Assembly. Install round pin into right side of door. Install left pin into slot. (As seen from inside of door)



LEFT

RIGHT

- b. Slide Shovel Assembly onto rails on door. Push shovel in fully.



5. **Drawer Lid Assembly:** Install Drawer Lid Assembly by opening the lid to view the insertion points. The tabs on the left and right sides of the Drawer Lid Assembly will slip into the brackets on the Drawer Sleeve. Close lid once installed.



6. **Add Oil to Oil Vat:** It is the simplest to add oil to the oil vat now, prior to attaching the Basket. Fill to COLD level.



7. **Install Basket:** Install the Basket by placing the ends of the basket into the slots on the left and right side of the unit.



LEFT



RIGHT

CLEANING

DAILY MAINTENANCE

CAUTION

Do not unplug the fryer and always make sure the fryer is turned off.

CAUTION

Do not touch heating element, oil vat or oil unless you are sure it has cooled.

1. Wipe basket with paper towel to remove crumbs and food particles.
2. Wipe crumbs, oil and any other food matter from inside of drawer using a paper towel.
3. Clean outside of fryer with a good stainless steel cleaner and wipe dry.

CAUTION

Do not clean the outside or any other stainless steel part using abrasive cleaners.

4. Check oil level on the back of vat to make sure it is up to cold line (at room temperature). If not, add oil as necessary. Replace the cooking oil once a week or more often if necessary. Use a **COMMERCIAL GRADE DEEP FRY COOKING OIL**.

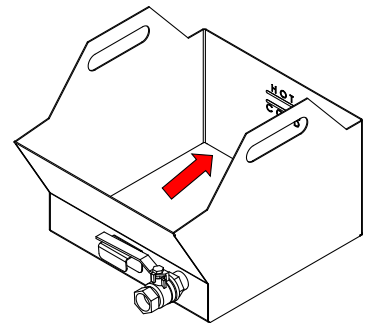
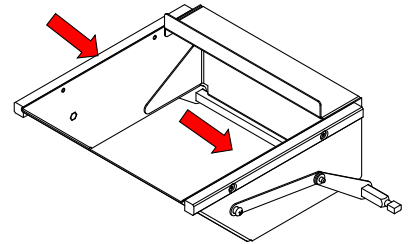

WEEKLY MAINTENANCE

CAUTION

Do not unplug the fryer and always make sure the fryer is turned off.

CAUTION

Do not touch heating element, oil vat or oil unless you are sure it has cooled.

1. Open front panel by turning latches. Remove drawer parts and wash in soap and hot water. Rinse well in hot water and dry
2. Remove air filter cartridge and set aside (for replacement, refer to “Steps to replace air filter cartridge” on page 17).

CAUTION

Do not wash air filter cartridge.

3. Remove grease filter tray from cabinet. Remove grease filter from tray and drain any oil that has accumulated. Wash both parts in soap and hot water. Rinse well in hot water and dry.



4. Attach oil hose and drain cooking oil from vat into containers for disposal. Have empty containers handy for proper disposal of used cooking oil. A rendering company can help with proper disposal.



Alternate Oil Vat Drain Connection and Hose Option shown

5. Remove basket and lift cable to raise element.



6. Remove spill tray and drain any oil that has accumulated. Wash in soap and hot water. Rinse well in hot water and dry.
7. With internal components removed, clean cooking and filter compartments with grease cutting soap or oven cleaner if necessary. Rinse with damp cloth and dry.
8. Clean countertop and external surfaces.
9. Ensure that blow-off caps on fire extinguisher nozzles are kept in place.
10. Re-install all parts.

PERIODIC MAINTENANCE

Air Filter Cartridge Replacement

- Replace the air filter cartridge at least once every 2 months, more often for higher volume usage. Replacement is safer and easier when the fryer is cool rather than hot.
- Only PERFECT FRY filters may be used in your Perfect Fry unit.

Steps to replace air filter cartridge

1. Open front panel by turning latches
2. Release latch on air filter cage, and remove air filter cage and air filter cartridge from filter compartment
3. Remove old used air filter cartridge from air filter cage.
4. Wipe air filter cage clean.
5. Fit air filter cage over new air filter cartridge and write date on cartridge. (↑↑ Arrows up)
6. Install air filter cage and new air filter cartridge firmly back into filter compartment and latch in place.
7. Close front panel and latch shut.



PFS Automatic Extinguisher

- The PFS automatic extinguisher must be inspected monthly by the owner/operator and semi-annually by authorized service personnel as per NFPA 17A. It is important that a maintenance program is set up with a local fire service company to ensure that local jurisdictional codes are being met. Please refer to PFS Automatic Extinguisher section of this manual for more information.

OPERATING INSTRUCTIONS

TIPS ON DEEP FRYING

GREAT FOOD IN LESS TIME

- **Use premium quality commercial deep frying oil.** Canola and Soybean oils are recommended. Do not use household cooking oils from your local supermarket. Poor quality oils may shorten the life of the air filter cartridge.
- **Keep food frozen until ready to fry.** Frozen product will absorb less oil during the cooking process.
- **Remove ice from food.** Ice results in excess bubbling and spillage of oil out of the vat.
- **Minimize the moisture.** Excess moisture extends the cooking time. Water, ice, sugar and breading all contribute to shortening the life of the oil.

MINIMIZE THE MOISTURE

REDUCE THE COOKING TIME

MAXIMIZE THE PROFIT

- **Try to reduce the amount of breading that falls off of the food.** Breading often has sugar and other ingredients that will reduce the oil's life and darken the appearance of food. Consider filtering the oil to remove the breading particles.
- **Do not overfill the drawer.** Excess food may not be cooked properly

COMMON QUESTIONS

• How Much Oil to Use?

The PERFECT FRY has a capacity of 2.9 gallons(11L) of oil. Fill the oil vat to the COLD line only.

• How Much to Fry?

Fill the drawer to the top only. The drawer has an approximate capacity of 3 lbs (1.5 kg) of product per cycle. Whatever you can fit in the drawer is what you can fry.

• What is the Ideal Temperature Range for Cooking?

The ideal temperature range for cooking product is between 350°F and 360°F (177°C and 182°C). The factory default setting for cooking temperature is 350°F (177°C). When frying at too low a temperature, food absorbs more oil which increases oil consumption.

• Should Frozen Food Be Defrosted?

DO NOT THAW FROZEN FOOD! Frozen foods only should be put directly into the fryer in order to minimize moisture.

• Can I Refreeze Frozen Foods?

NO, do not refreeze frozen foods. Foods that are refrozen can absorb more oil, which will result in a dry, brittle and tasteless product.

OIL FACTS

Frying oil is especially formulated to withstand high temperatures. For this reason, you must ensure you are using the right product. Liquid vegetable shortening is produced by several companies; the oil has an additive and/or has been formulated to increase the performance during high temperature usage.

DO NOT USE OIL THAT IS RECOMMENDED BOTH FOR SALAD AND FRYING!

Fill the oil vat to the COLD line only. The oil expands as it heats and if overfilled, the bottom of the basket will remain in the oil when in the up/serve position.

Excessive Oil Usage?

The fried product is absorbing oil. Possible reasons for this include:

- Excess breading or batter, shake off excess before frying.
- Allow basket to drain longer, adjust the drain time.
- Food is being allowed to thaw before frying.

Cleaning Your Fryer?

- Refer to the Cleaning section of this owner's manual. Remember to clean the basket and drawer daily.

Filtering Your Oil?

The most important procedure you can do is to maintain the oil, extending its life:

- Filter at least once a day, preferably first thing in the morning when the oil is at room temperature.
- Filtering removes all the contaminants from the previous days cooking.
- Clean the oil vat.

Points to Remember:

- Keep drawer and basket clean and free of breading/batter build up.
- Clean at least once a week and rinse thoroughly.
- Do not overheat oil.
- Use the standby mode when possible.
- Do not salt product prior to frying.
- Drain fried foods before serving.
- Maintain oil level in vat, check to ensure it is at the hot line often.
- The oil is dead when foaming appears continuously on the oil surface.
- Fill the drawer no higher than the top. Do not overfill the drawer.

Your oil, product taste, and customers depend on you.

If the oil temperature is set too high, the food will cook on the exterior and the interior will be undercooked. When the interior is cooked completely, the exterior will be overdone or burnt. The higher temperature will also cause the oil to break down faster and smoke.

During slow periods, take advantage of the standby mode which allows the oil to cool down to 275°F (135°C), prolonging the oil life and reducing energy costs while allowing quick recover time when required.

The oil temperature should not be adjusted when cooking different products. Adjust the cooking time instead.

Frozen Foods

Put frozen foods directly into the fryer. **DO NOT THAW FROZEN FOODS!** Blot excess water from food before frying. Remove ice crystals that may be at the bottom of the product bag.

OIL AND WATER DO NOT MIX! Water reacts with oil and makes it break down rapidly resulting in darkening, smoking and foaming (a process called hydrolysis). Excess water in the oil can cause the following problems:

- Unnecessary temperature drop meaning longer cooking times.
- More energy usage to maintain cooking temperature.
- Excessive splattering inside the fryer resulting in a mess to clean up.
- Decreased life of the air filter and the oil.

Refreezing Frozen Foods?

Frozen foods should be fried frozen. Foods that are refrozen can absorb more oil and make your fried foods taste greasy. Refrozen food forms excessive ice and these ice crystals can bond food pieces together causing clumping. Remember:

- Always FRY FOOD FROZEN.
- NEVER REFREEZE thawed food
- REMOVE ice crystals from product before frying.
- DO NOT accept thawed or refrozen product from supplier.

Excessive Foaming?

The main reason for foaming is improper rinsing of oil vat after cleaning:

- To remove soap residue, rinse 3 times with water after cleaning or neutralize with a water and vinegar solution (1 part white vinegar to 2 parts water).
- Take care of your oil; use standby mode during slow periods. High temperature and oxygen contribute to oil breakdown. Filter oil and clean vat at least once a day when using heavily breaded products.

Excessive Smoking/Oil Darkening?

- Oil is too hot, check temperature.
- Inadequate filtering, breading or batter build-up in vat causes oil breakdown, giving food a bitter taste.
- Moisture content is too high. Use precooked frozen products only. Remember to remove ice crystals.

Food Not Browning Properly?

- New oil may not brown the product; check color again after a few basket loads.
- Too much product is in the basket; fill no higher than the fill line.
- Product is not frying long enough, follow manufacturers suggested cooking times.
- Oil temperature is too low, check oil temperature.
- Product is frying in excess foam.
- Oil level is too low, check the oil level.

Premature Oil Breakdown?

- Oil is at full temperature during slow periods, use standby mode.
- Oil is contaminated. Never use wire brushes, copper pads or steel wool for cleaning. Use a hard bristle brush and filter oil regularly. Rinse with water vinegar solution.
- Also, see section; **HOW HOT IS TOO HOT?**

Statements used in OIL FACTS section are taken from:

- NAFEM Food Service Industry
- Canola Research Foundation
- Sysco Oil Publication

STARTING UP

Upon powering the Perfect Fry, the control will boot to a screen displaying the Perfect Fry Logo, and a prompt to Tap Screen To Continue. Tapping the screen will progress the unit to a brief system check, ensuring all functions are ready for use.

Once the system check is complete, the control displays the HOME SCREEN.



From this screen you will be able to access your primary frying modes as well as the additional features of the Perfect Fry® unit. To begin heating the unit, Manual or Recipe frying must be selected.

MANUAL MODE FRYING

1. From the Home Screen select the Manual frying tile.

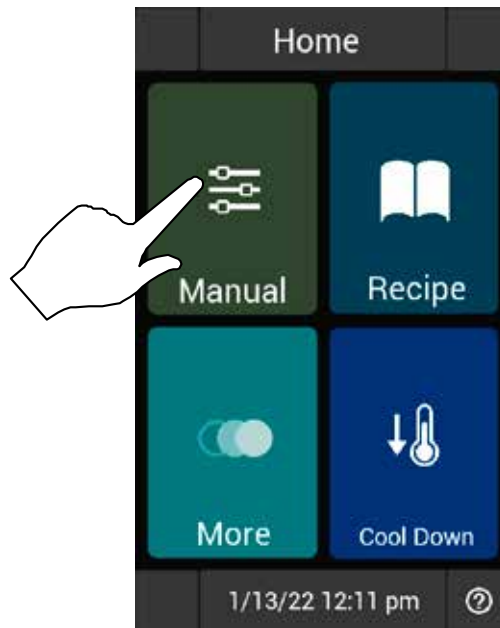

2. The preheat screen is displayed.
 - Select TIME to set the desired frying time.
 - Select TEMP to set the desired oil temperature setpoint.
 - The bottom red bar displays the heating progress toward the temperature setpoint. To view the current oil temperature, press the red bar. The current oil temperature will be displayed in yellow.

- When the oil has reached the set temperature, the unit beeps and the FRYER READY screen is displayed.

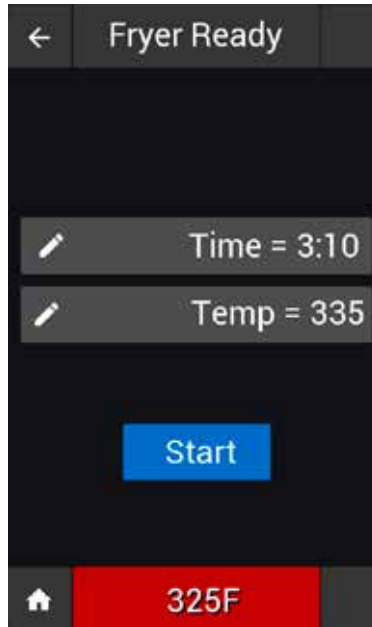

- Press the START key. The unit will prompt the operator to LOAD PRODUCT.

The PFA recognizes the opening and closing of the feeder drawer lid as indication a product has been loaded. Once a product has been loaded, the drawer retracts, moving the product into the fry basket. The timer begins counting down. The product will automatically unload when the frying time has elapsed.

- Once complete, REPEAT may be selected to initiate another frying cycle under the same conditions, or select CANCEL to return to the TIME & TEMP ENTRY screen.

RECIPE MODE FRYING

1. From the HOME SCREEN, press the RECIPE key.

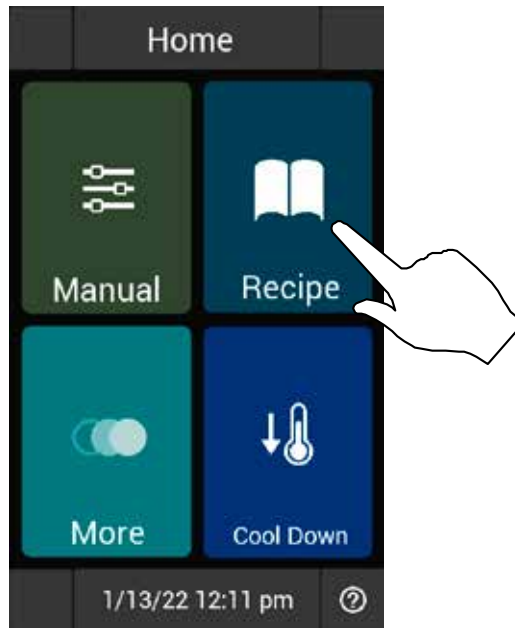

2. The SELECT GROUP screen is displayed. This screen lists all available groups. Select desired group.

A Group is comprised of recipes with the same desired oil temperature. More information on editing of recipes & groups, may be found in the respective sections of this manual.

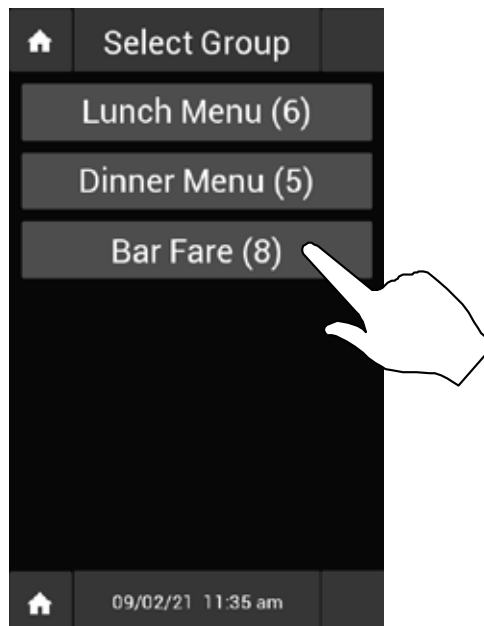

3. The control displays the PREHEATING screen. This screen lists all available recipes within the group.

The bottom red bar displays the heating progress toward the temperature setpoint. To view the current oil temperature, press the red bar. The current oil temperature will be displayed in yellow.

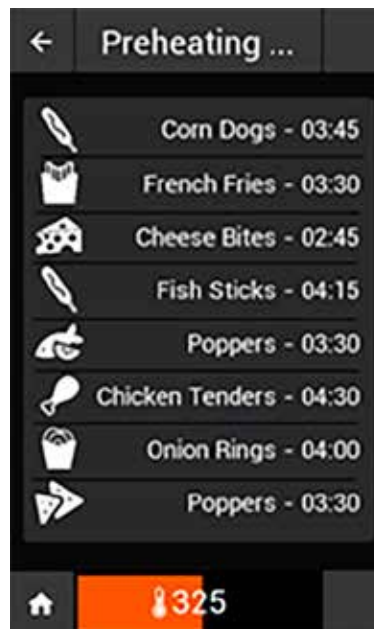

4. Once the oil has reached the preset temperature and is ready to fry, the control displays the SELECT A RECIPE screen.

Icons for each of the recipes in the group are displayed at the top of the screen. Select the desired product using one of the following:

- **Drag & Drop:** Press, hold and drag the icon of the desired product to the Select A Recipe area of the screen. Release the image in this area to assign the recipe.
- **Select & Assign:** Press the product icon to highlight the tile. With the tile highlighted, select the Select A Recipe area to assign the recipe.



5. Once a product has been assigned the unit will prompt to LOAD PRODUCT.

The PFA recognizes the opening and closing of the feeder drawer lid as indication a product has been loaded. Once a product has been loaded, the drawer retracts, moving the product into the fry basket. The timer begins counting down. The product will automatically unload when the frying time has elapsed.

6. Once complete, REPEAT may be selected to initiate another frying cycle under the same conditions, or select CANCEL to return to the SELECT A RECIPE screen.



RAPID FRY

After a product has been loaded into the oil, the unit will provide the option to prepare the next product for frying.

1. While a product is frying, Select Next Recipe will appear below the current frying timer.
2. The SELECT A RECIPE screen is displayed. Select desired next recipe.

Assigning a recipe to this position will prompt to load. Once loaded this product fry will commence immediately after the current product has finished frying, and unloading.

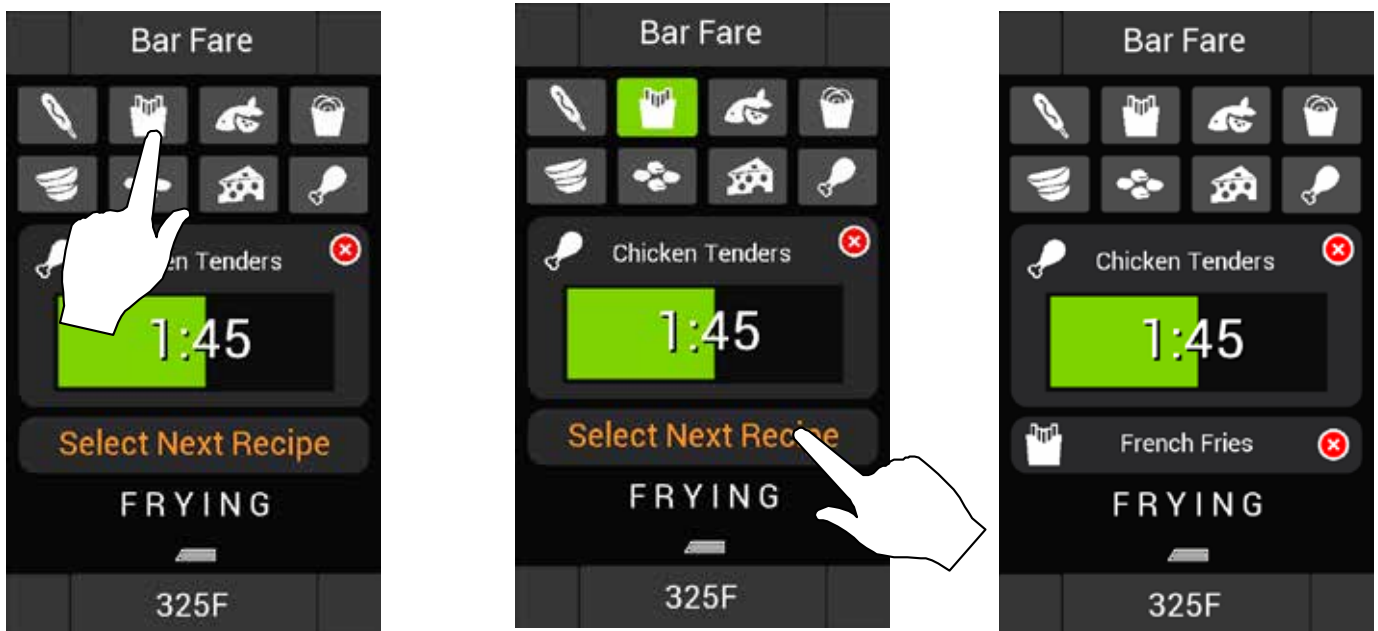

DUAL LOAD

Dual load frying is affiliated with a special recipe type. These recipes load a second product into the oil while the first is frying, so that both products finish frying simultaneously. See EDITING a RECIPE for instructions on programming a DUAL LOAD PRODUCT.

NOTE: There is only one holding position for secondary products, therefore, Dual Load products cannot be selected when using Rapid Fry.

Dual load recipes contain two timings

- The first time is the fry time of the product that takes the longest to complete.
- The second timing is the second product frying time. When the recipe has this time remaining, it will add the second product, so that both products finish at the same time.

When a dual load recipe is assigned to cook, the unit will prompt the loading of the first product. Once this product has been placed in the oil, the unit will prompt for the loading of the second product. Once the second product has been placed in the drawer, the unit will display “waiting for MM:SS”. Once the wait time has been reached (defined in recipe settings), the unit will move the product to the frying oil.

Example: Chicken Tenders and Waffle Fries

In the event that two products are commonly served in combination, it may be desirable to have them be ready to serve simultaneously. Suppose we have chicken tenders that take 6 minutes to fry, and waffle fries with a 3-minute fry time [both products must fry at same oil temperature].

- Create a dual load recipe with TIME 1 of 6 minutes and TIME 2 of 3 minutes.
- Load and begin frying the chicken tenders
- Load the waffle fries while the tenders are frying
- Both products will finish frying at the same time



CANCELING A RECIPE

1. To cancel a recipe, press the Red X next to the product name.



2. The CANCEL YES/NO screen is displayed.

If the product has not yet been loaded, the space will be cleared for a new assignment.

If the product has already been loaded into the fryer, the unit will dispense the product before allowing a new item to be assigned.

You cannot cancel a recipe while the drawer or basket is in motion. Once the drawer and/or motor have finished their current motions the cancel key will become available again.



STANDBY MODE

Standby mode is an optional feature that may be enabled for energy savings during idle periods. If the unit features an activated Standby Mode, it will exit the frying screen after a set duration has elapsed with no user interaction, and begin regulating at a lower temperature. This lower temperature helps conserve energy during the idle period, while ensuring relatively quick preheating should the unit be placed back into a fry mode. If the unit is allowed to remain in Standby mode for the duration defined by the Standby Heat Off parameter, all heating will cease until the user re-enters a cook mode.

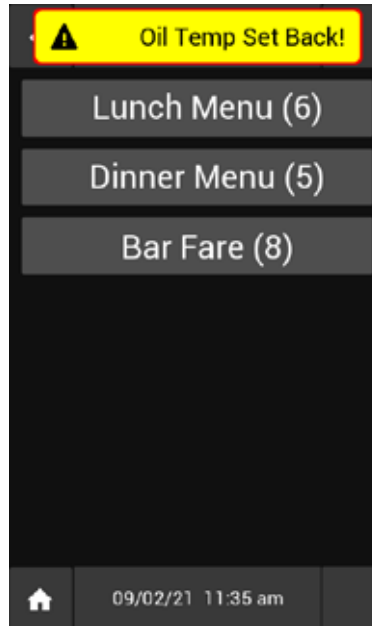

SHUT DOWN / COOL DOWN OPERATIONS

When the unit is in the HOME, MORE, or COOL DOWN screens the unit will initiate cooling procedures. The unit will continue to run the system fans until the oil has achieved a temperature less than 122°F. At this point the unit will return to the logo screen (OFF) automatically.

Press the screen to initiate the system checks and return the user to the HOME screen. To monitor the progress of the cooling, select COOL DOWN from the Home screen. The control displays the actual oil temperature.

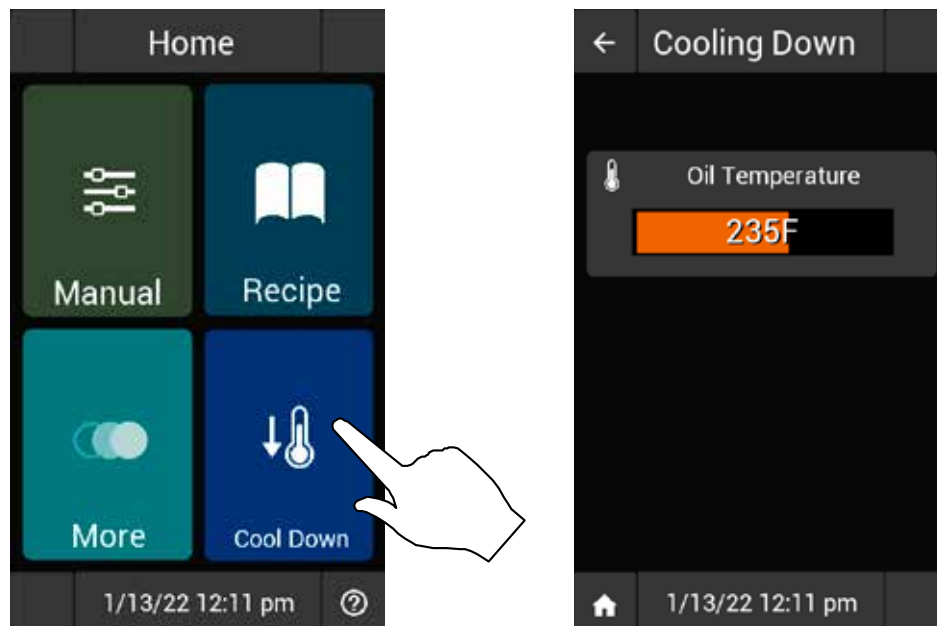

EDIT A RECIPE

1. Select MORE from the HOME screen. Additional options will be displayed.
2. Selecting EDITING. Then select the EDIT RECIPE key. The control displays the RECIPE LIBRARY screen.

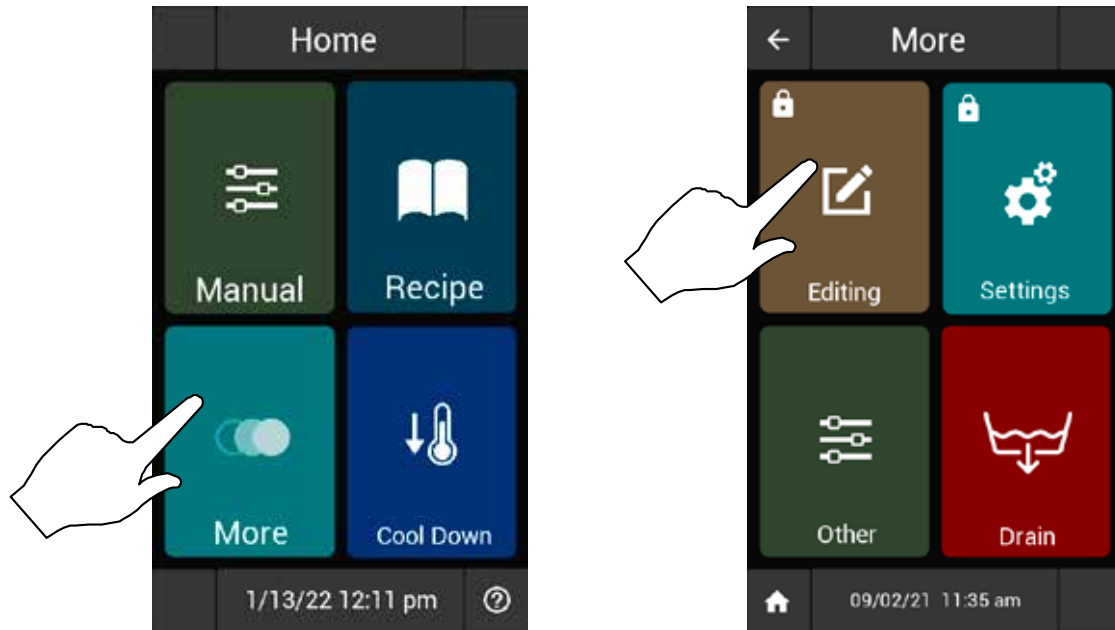

3. Use the Up and Down arrow keys at right side of the display to scroll through the list of up to 16 recipes.

The unit has several recipes pre-programmed from factory. These can be overwritten or one of the spaces labeled "Recipe #" can be used to create a new recipe.

4. Select the recipe you wish to edit. The control display the RECIPE DETAILS menu.

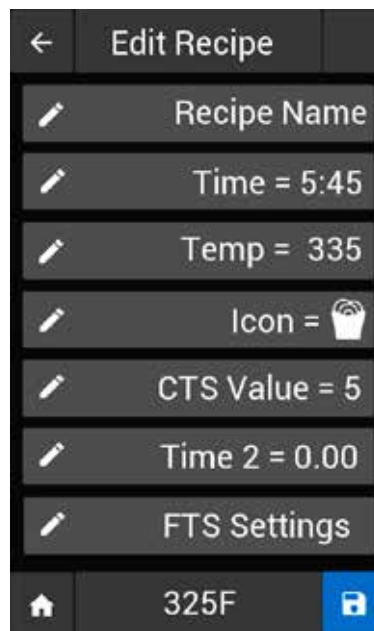

5. Press on the parameter you wish to edit. From this menu you can define the following options:

- Recipe Name
- Cook Time
- Cook Temperature
- Recipe Icon
- Recipe CTS Value (see below for more information)
- Time 2 (Dual load Recipe Time, see below for more information)
- FTS options (see below for more information)

CTS (Cook Time Sensitivity)

CTS adjusts frying time to compensate for the decrease in frying oil temperature when a basket of product is placed into the fryer. CTS increases frying time to accommodate for differences in product moisture content, basket-load size, and initial temperature.

A proper CTS setting will ensure a high-quality product. For example; 2 lbs. of French fries will cook to the same quality as only 6 ounces of French Fries.

In addition to having an optional “global” CTS setting for manually entered cook cycles, each preset can be programmed with its own individual setting. This provides for flexibility among different food products.

Some experimenting with the range of 1 (lowest compensation) to 9 (highest compensation) may be required to achieve optimum quality.

- A value of 5 is a good place to start and is the default.
- A setting of 0 means no CTS at all.
- The cook time will always be as defined in the recipe settings.

FTS (Food Type Sensitivity)

FTS adjusts fry cycle loading and unloading sequences to compensate for differences among food products. Each preset can be programmed with its own individual setting. This provides flexibility among different food products.

FTS OPTIONS:

- **Start: In oil/ Drain** - Defines if basket will be directly in oil or slightly above when product is loaded.
- **Shake @ 15s, 30s, 45s, 60s** - Defines if basket will lift at respective time, to prevent product from clumping during frying process. “s” = seconds.
- **Unloads: 1-4** - Defines how many times unit will shake basket in unload position to fully dispense product.

Dual Load Recipe (Time 2)

Dual load recipes contain two timings. The second timing is the second products cook time. The second product will be loaded at the appropriate time for both products to finish at the same time.

6. Select the blue SAVE key in the bottom right of the screen to save the changes.
7. Select the BACK-ARROW key in the top left to return to the recipe library list.

NOTE: If the BACK-ARROW is selected prior to saving, the changes will not be saved.

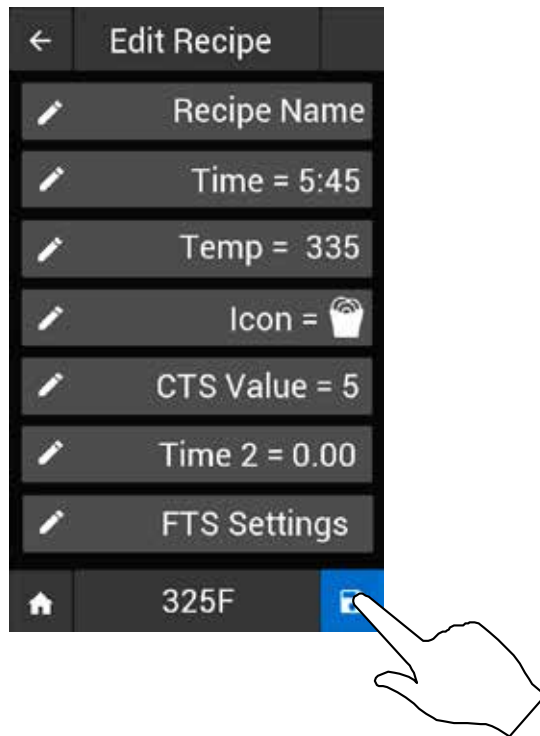

EDIT RECIPE GROUPS

A group is comprised of recipes with the same desired oil temperature. In order to fry a recipe, it must be assigned to a group. Up to 8 recipes may be assigned to a single group.

1. Select MORE from the HOME screen. Additional options will be displayed.
2. Selecting EDITING. Then select the EDIT GROUP key. The control displays the GROUP LIBRARY screen.

Groups that have yet to be defined are listed as "<name>".

Defined groups will list their title and the number of recipes assigned to them.

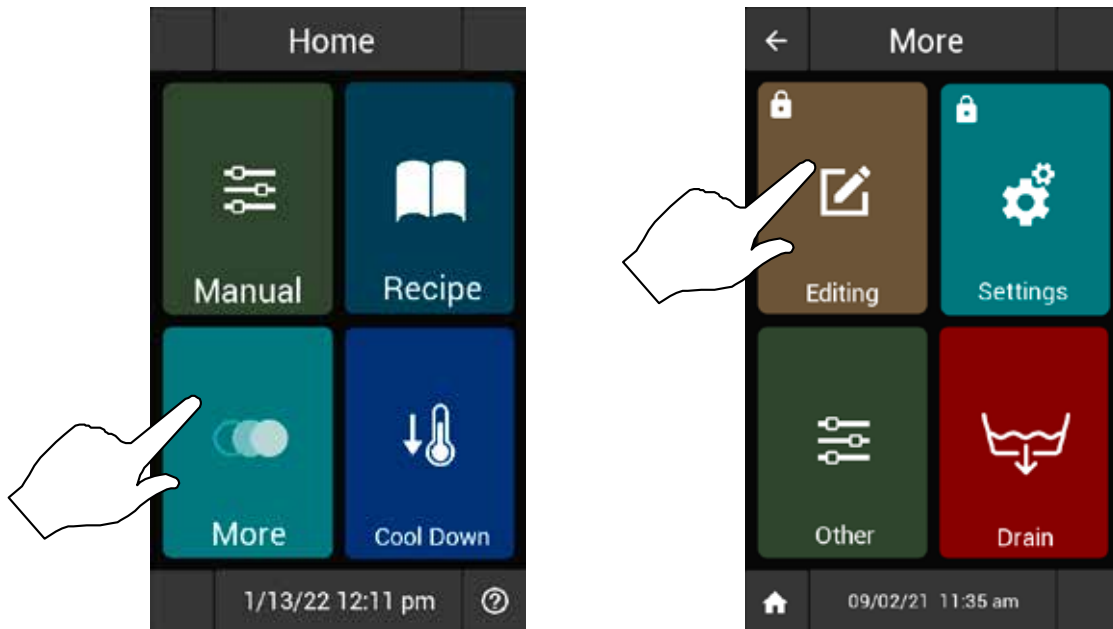

3. Selecting a Group will bring you into the GROUP EDITING menu for that specific group.

The top bar is the position for the group name. Selecting this region will allow you to enter a new name.

The lower bar shows the number of recipes assigned to the group. Selecting this bar will bring up the listing of the current recipe library, in the GROUP RECIPES menu.

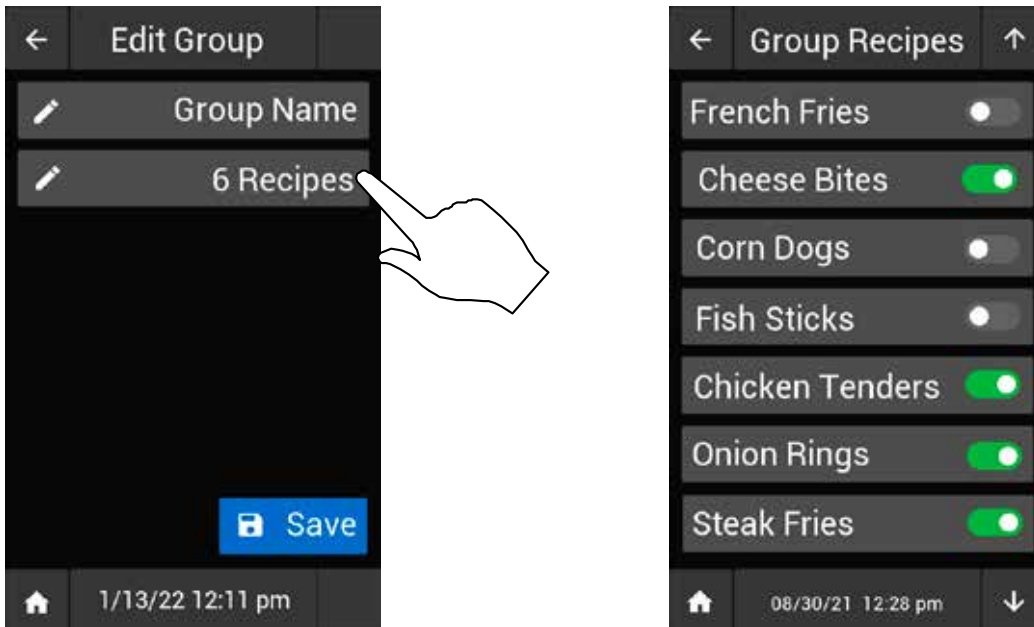

4. To add a recipe to the group, toggle the slider switch to the green ON position.

You may use the Up and Down arrow keys at the right of the screen to scroll through the recipe library.

The first recipe selected will define the frying temperature of the group. Any recipes that do not share that fry temperature will be greyed out, indicating they may not be added to the current group.

A group may hold up to 8 recipes.

5. When all desired recipes have been selected, press the back arrow in the top left to return to the Edit Group menu. The lower bar will now reflect the number of recipes that have been assigned to the group.
6. Select the blue SAVE key in the bottom right of the screen to save the changes.
7. Select the BACK-ARROW key in the top left to return to the group library list.

NOTE: If the BACK-ARROW is selected prior to saving, the changes will not be saved.

SETTINGS

1. Select MORE from the HOME screen. Additional options will be displayed.
2. Select SETTINGS. The control displays the SETTINGS menu.

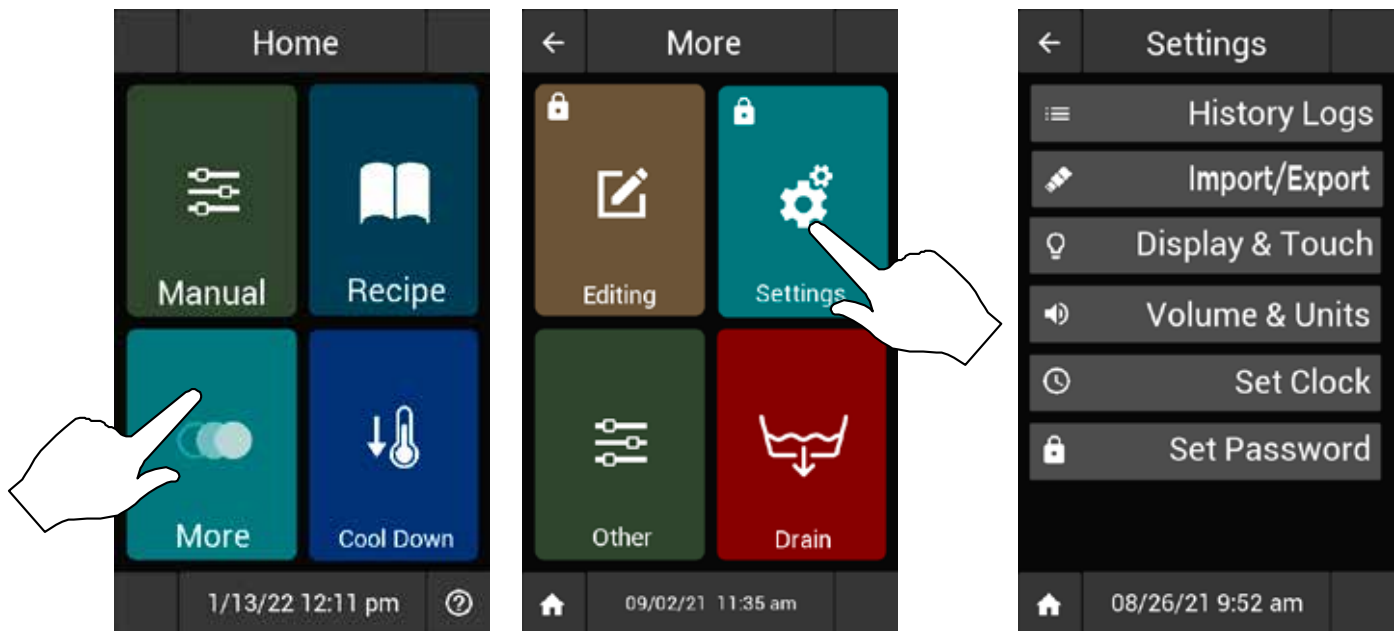

HISTORY LOGS

Note: All History log information may be exported to a USB drive in (.CSV) format to be read on a computer.

- **HACCP** - Average temperature and fry time of recent fry cycles (timestamped).
- **Machine Log** - Log of significant activity events. Ex. Recipe/Group creation & editing, Errors, USB operations.
- **User Counters**
 - Frying Hours - Total Hours in Frying menus (Recipe & Manual)
 - On Hours - Total hours unit has had power applied.
 - Heater Cycles - Number of times heat has cycled on.
 - Total Cooks - Number of complete recipe and manual timings.
 - Recipe Counts - Tally of particular product fry cycles, including manual.
- **Total Counters**
 - Frying Hours - Total Hours in Frying menus (Recipe & Manual)
 - On Hours - Total hours unit has had power applied.
 - Heater Cycles - Number of times heat has cycled on.
 - Total Cooks - Number of complete recipe and manual timings.
 - Recipe Counts - Tally of particular product fry cycles, including manual.

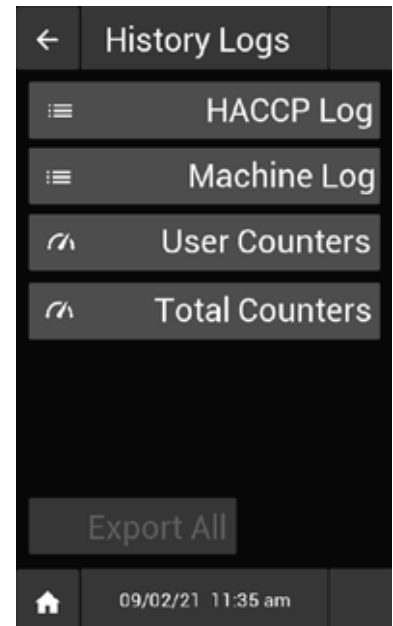

A user may clear the User Counters at any time in order to assist in data collection, such as hours run over a week, or serving counts on a particular product. Total Counters cannot be cleared by the user. This keeps an overall tally of the unit's operational time and activities, similar to a car's odometer.

IMPORT/EXPORT

USB Import

- **Version Update**
 - Checks USB for new version of software
 - If valid update may be initiated
- **Recipes** - Imports saved Recipes & Groups structure and settings.
- **Copy System** - Imports direct copy of previously saved system configuration, including unit particulars such as Serial number.
- **Clone System** - Imports previously saved system configuration to have unit mimic originating unit's performance.

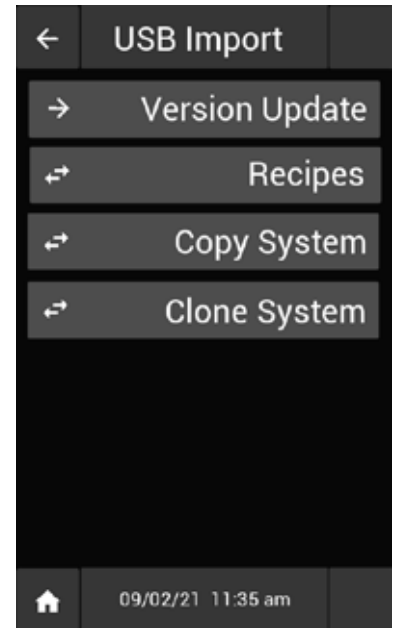

USB Export

- **Recipes (BIN)** - Recipe and group settings for import to another PFA fryer
- **Recipes (.CSV)** - Recipe and group settings for reading on a computer
- **System Cfg (.BIN)** - System configuration for import to another PFA fryer
- **System Cfg (.CSV)** - System configuration for reading on a computer
- **Motor History**

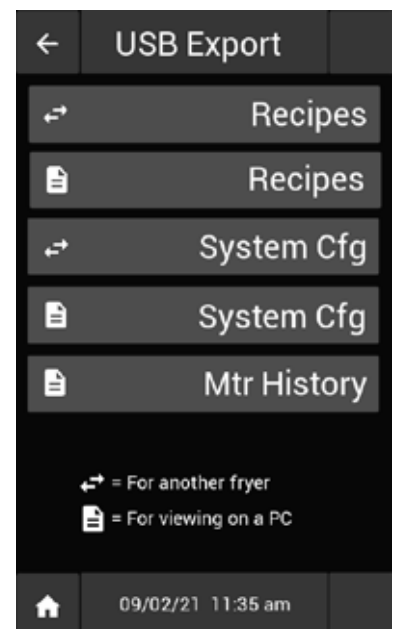

DISPLAY & TOUCH

- Change display Brightness
- Increase touch sensitivity with Glove Mode (On/Off).
- Further Increase touch sensitivity with Overlay Mode (On/Off).

VOLUME & UNITS

- Set Frying alert (Buzzer) volume.
- Set feedback (Key) volume.
- Define temperature units as Celsius/Fahrenheit.

SET CLOCK

- Allows input of time and date for display and record logging purposes.

SET PASSWORD

- Allows for input of new “User” level password to be set by owner/operator for limited access to the Manual cooking and Editing menus.

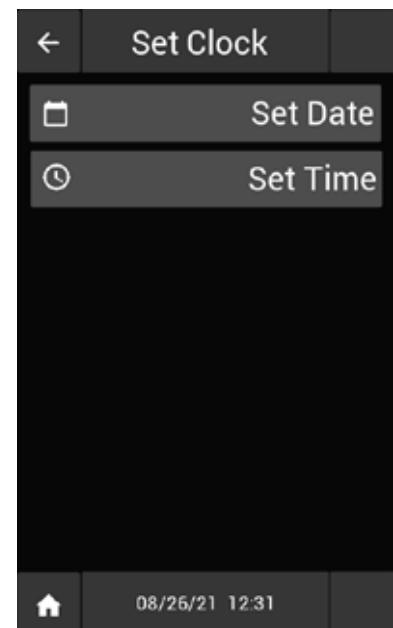
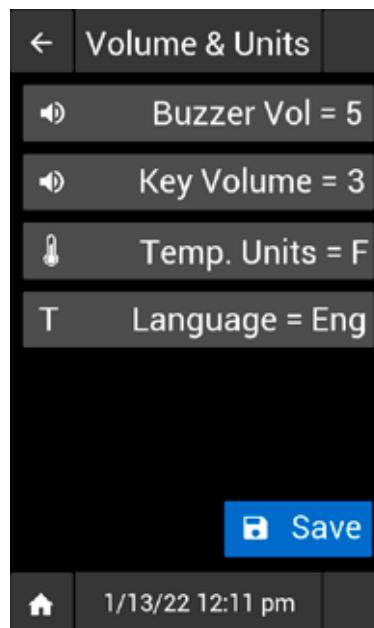
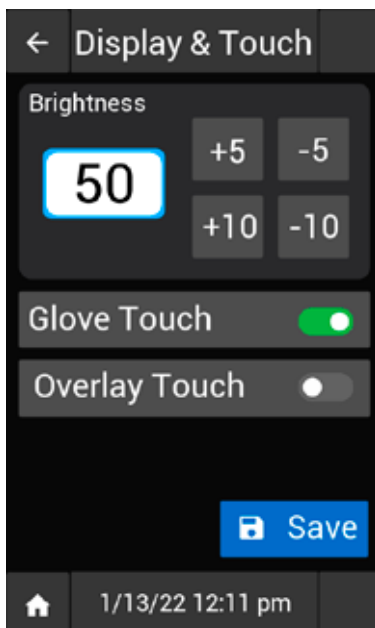

OPTIONAL PERFECT FILTER

The Perfect Filter allows restaurants to filter oil quickly and regularly, extending usability of the oil and increasing the product quality. Using the Perfect Filter is a 10-minute operation. Ensure that a 120v receptacle is nearby for filtering, unit is provided with a 13ft long power cord. The Perfect Filter uses replaceable paper filters that should be disposed of at the end of each day of use.

OPERATING INSTRUCTIONS

1. Assemble the Perfect Filter based on the Operation Manual provided with unit. Ensure all removable parts have been washed, rinsed, sanitized, and allowed to air dry before use.
2. Stop frying and ensure fryer is free of product and turned off. Open fryer door to help heat escape the unit. Take care as air leaving unit may be very hot, heat resistant gloves are recommended.
3. With heat resistant gloves, carefully remove fryer basket. Dispose of any crumbs or particulate in the basket and set aside.
4. Place Perfect Filter into oil vat. Unit may rest directly on the element. NOTE: ensure oil level lies between the (2) indicator arrows on unit.
5. Route power cable to the nearest 120V receptacle. Ensure that the cord is NOT in the oil, the cord MUST stay dry. Ensure that cable is not a trip hazard.
6. Begin filtering oil by pressing the “Start/Stop” button on the top of the Perfect Filter. The filter process will take approximately 4 ½ minutes. Once complete the unit will turn off automatically.
7. Once the unit has finished filtering and turned off, remove the Perfect Filter from the oil vat. Pause during removal to allow residual oil to drain back into the vat. After draining, place the Perfect Filter into the provided drip pan and set aside.
8. With heat resistant gloves, replace the fryer basket. Then close the fryer door and turn the unit back on. Once the home screen reappears, the operator is ready to select the next recipe.
9. Store the Perfect Filter near fryer when not in use. Ensure all removable parts are washed, rinsed, sanitized, and allowed to air dry.



Step 1



Step 2



Step 3



Step 4



Step 5



Step 6



Step 7



Step 8

OPTIONAL REMOTE ALARM INTERFACE:

Perfect Fry models offer an option of a Remote Alarm Interface. The option allows for a wired connection to a location's alarm system. The option is not mandatory as Perfect Fryer models meet all regulatory compliance standards; however, some locations are asked to include this feature by local authorities. The option can be purchased in advance or installed on location afterwards.

MAINTENANCE

ERROR FAULTS & TROUBLESHOOTING

The PFA is equipped with multiple diagnostic sensors in order to maintain safe and consistent operation.

- Some critical conditions will block the user from operating the unit until resolved.
- Minor alerts are presented to the user to prompt general cleaning and maintenance, which if neglected may lead to more substantial issues.

If an issue persists after clearing the error, attempt rebooting the control as follows.

1. Press and hold the area shown in the following image until the unit beeps (approximately 5 seconds).
2. If the issue is still not resolved, call Perfect Fry technical service at 1-802-864-0183, option 4 for additional assistance.



TROUBLESHOOTING MAIN FAN

PROBLEM	PROBABLE CAUSE	PROBABLE SOLUTION
Main Fan Speed High	The RPM feedback from the main fan is higher than anticipated.	Check that the fan is rotating as expected.
Main Fan Speed Low (Critical)	The RPM feedback from the main fan is lower than anticipated.	Check that the fan is rotating as expected.
Main Fan Current High	The current for the main fan is higher than anticipated.	Check that the fan is spinning freely, not impeded or restricted.
Main Fan Current Low	The current for the main fan is low than anticipated.	Check that the fan is operating
Main Fan Inrush High	The starting current for the fan is higher than anticipated.	Check that the main Fan is spinning freely, not impeded or restricted.

TROUBLESHOOTING CONTROL FAN

PROBLEM	PROBABLE CAUSE	PROBABLE SOLUTION
Control Fan Speed High	The RPM feedback from the fan is higher than anticipated	Check that the fan is rotating as expected.
Control Fan Speed Low	The RPM feedback from the fan is lower than anticipated.	Check that the fan is rotating as expected.
Control Fan Current High	The current for the fan is higher than anticipated.	Check that the fan is spinning freely, not impeded or restricted.
Control Fan Current Low	The current for the fan is lower than anticipated.	Check that the fan is operating.
Control Fan Inrush High	The starting current for the fan is higher than anticipated.	Check that the fan is spinning freely, not impeded or restricted. Clean fan guard at rear of unit.

TROUBLESHOOTING BASKET MOTOR

PROBLEM	PROBABLE CAUSE	PROBABLE SOLUTION
Basket Motor Overrun	Motor has run without too long, without intended position feedback.	Check basket is properly installed.
Basket Motor Current Low	Check that basket is installed.	Verify basket is moving as intended.
Basket Motor Current High	Check that basket is installed correctly.	If occurring with product, ensure product is not in excess of recommend load weight.
Basket Motor Inrush High	Check that basket is installed correctly.	If occurring with product, ensure product is not in excess of recommend load weight.

TROUBLESHOOTING DRAWER MOTOR

PROBLEM	PROBABLE CAUSE	PROBABLE SOLUTION
Drawer Motor Overrun	Motor has run without too long, without intended position feedback.	Check loading drawer is properly installed.
Drawer Motor Current Low	Check that loading drawer is installed.	Verify loading drawer is moving as intended.
Drawer Motor Current High	Check that loading drawer is installed correctly.	If occurring with product, ensure product is not in excess of recommend load weight.
Drawer Motor Inrush High	Check that loading drawer is installed correctly.	If occurring with product, ensure product is not in excess of recommend load weight.

TROUBLESHOOTING OTHER

PROBLEM	PROBABLE CAUSE	PROBABLE SOLUTION
Close Front Panel (Critical)	Front panel is registered as open.	Ensure panel is closer and locked in position
Fire Ext Sw. Open (Critical)	The pressure reading for the fire extinguisher is low	Check if extinguisher has discharged, or has become depressurized (gauge).
Grease Filter Switch Open (Critical)	Grease filter is not registered as being installed	Check filter is installed correctly
Air Filter Switch Open (Critical)	Air filter is not registered as being installed	Check filter is installed correctly
Air Flow Switch Closed (Critical)	Ensure front and rear vents are not obstructed	Clean grease filter If issue persists, replace air filter.
Temp/Element Sw Open (Critical)	The element position switch is not engaged, or high limit device has been tripped, check oil level is not too low.	If element position was recently adjusted for cleaning or maintenance, check element is fully seated in vat. If presented while unit is heated, allow time for unit to cool, then attempt reset high limit in the rear of unit.
PCB High Temp (Critical)	Control is registering high temperatures. Clean fan guard at rear of unit.	Allow time for unit to cool, then reattempt operation
Board Temp Error (Critical)	Control is registering erroneous temperatures (<32°F).	Call for service
Temp Probe Failure (Critical)	Probe is register open circuit (>482°F).	Call for service
Probe Wiring Error (Critical)	Temperature probe feedback is erroneous	Call for service
Oil Too Hot (Critical)	Probe is registering oil temperature over 437°F	Allow unit to cool prior to attempting operation.

PFS AUTOMATIC EXTINGUISHER

NOTE: Please refer to the PFS Automatic Extinguisher Installation, Inspection, Maintenance & Recharge Manual (83595) for more detailed information.

 **CAUTION** The PFS must be stored above 32°F (0°C)

1. GENERAL DESCRIPTION

The PFS consists of a cylinder assembly (with pressure switch and gauge), actuating lever, fusible link assembly, manual pull station, and two nozzles. It is designed and acceptable for use in areas that have ambient conditions between 32°F (0°C) and 50°C (120°F).

2. OPERATION

Automatic Operation

Upon the detection of a fire, the PFS will automatically operate. The fusible link rated at 280°F (138°C) will operate when exposed to the fire and operate the PFS automatic extinguisher unit. When operated, the PFS unit will discharge wet chemical agent through the provided discharge piping and distribution nozzles.

Manual Operation

The PFS unit can also be operated manually by pulling the remote lever (to be mounted on the front of the cooking appliance) that is clearly marked “In Case Of Fire - PULL”.

IMPORTANT:

The manual pull handle is to be pulled **ONLY IN CASE OF FIRE** in the Perfect Fry unit (use when the automatic system has failed).



NOTE: Power shut-off is also achieved by system operation. If the pressure in the cylinder(s) drops below 92 psi (6.3 bar), the pressure switch opens, deactivating the power relay causing the appliance to de-energize.

3. INSPECTION & MAINTENANCE

The PFS Automatic Extinguisher must be serviced on a regular basis. Three types of servicing are required by NFPA 17A:

Monthly

An inspection or “quick check” must be conducted by the owner/operator and include verification of the following:

1. The PFS is in its proper location.
2. The PFS shows no physical damage or condition that might prevent operation.
3. The pressure gauge is in the green operating range.
4. The maintenance tag is in place and is up to date.
5. The manual pull is unobstructed.
6. The nozzle blow-off caps are intact and undamaged.
7. At least monthly, the date the inspection is performed and the initials of the person performing the inspection shall be recorded.

Semi-Annually

Maintenance must be conducted by a service technician that is trained and shall have passed a written or online test that is acceptable to the authority having jurisdiction. Maintenance shall be performed at intervals no more than 6 months apart as outlined in NFPA 17A and shall include the following::

1. A check to see that the hazard has not changed.
2. Examination of the fusible link, cylinder, tubing, nozzles and all auxiliary equipment.
3. Fusible links must be replaced at least Semi-annually from the date of installation. They must be destroyed when removed. Only use Perfect Fry part number: [83658](#), in the detection line. A fusible link loaded with grease or other material can result in an excessive delay in actuation.
4. Verification that the agent distribution piping is not obstructed. Remove the blow-off caps ([83108](#)) from the nozzles to ensure that they are free of grease build-up and inspect them for deterioration. Replace them as necessary.

5. Where semi-annual maintenance of any wet chemical containers or PFS components reveals conditions such as, but not limited to, corrosion or pitting in excess of manufactured limits, structural damage or fire damage, repairs by soldering, welding, or brazing, the affected part(s) shall be replaced or hydrostatically tested. The hydrostatic testing of wet chemical containers shall follow the applicable procedures outlined in NFPA 17A.
6. All wet chemical systems must be tested for proper operation, which shall include operation of the detection system signals and releasing devices, including the manual pull station and other associated equipment. A discharge of the wet chemical is not a required part of the test.
 - a. Simply disconnect one lead from the pressure switch to initiate appliance shut-down.
7. Where the maintenance of the PFS reveals defective parts that could cause an impairment or failure of proper operation of the PFS, the affected parts must be replaced or repaired.

8. The maintenance report, with recommendations if any, shall be filed with the owner or with the designated party responsible for the PFS.
9. The PFS must have a tag or label indicating the month and year the maintenance is performed and identifying the person performing the service. Only the current tag or label must remain in place.

Twelve Years

Maintenance must be done by authorized service personnel, as per NFPA 17A and include the following:

1. The wet chemical extinguishing agent must be removed and discarded.
2. The cylinder needs to be hydrostatically tested to 300 psi (21 bar).
3. If the cylinder shows no signs of rupture or distortion, recharge the PFS as directed in the recharging instructions.

SEMI-ANNUAL INSPECTION & MAINTENANCE (I & M) LOG: PERFECT FRY Serial No. _____

Date _____ I & M by _____	Date _____ I & M by _____
Date _____ I & M by _____	Date _____ I & M by _____
Date _____ I & M by _____	Date _____ I & M by _____
Date _____ I & M by _____	Date _____ I & M by _____
Date _____ I & M by _____	Date _____ I & M by _____
Date _____ I & M by _____	Date _____ I & M by _____
Date _____ I & M by _____	Date _____ I & M by _____
Date _____ I & M by _____	Date _____ I & M by _____
Date _____ I & M by _____	Date _____ I & M by _____
Date _____ I & M by _____	Date _____ I & M by _____
Date _____ I & M by _____	Date _____ I & M by _____

ORIGINAL STANDARD EQUIPMENT LIMITED WARRANTY

US & CANADA

Effective January 1, 2018, Serial Number E18AA000000

GENERAL WARRANTY

Perfect Fry warrants to the original purchaser of its commercial cooking appliances and related equipment that said appliances and related equipment will be free from defects in material and workmanship under normal use for a period of one (1) year from the date of installation, with appropriate documentation, to a maximum of fifteen (15) months from the date of manufacture, subject to the following additions, exceptions, exclusions and limitations.

WHAT IS COVERED

This warranty is limited to the repair or replacement at the Company's option, without charge, of any part found to be defective within the warranty period and reasonable expenses incurred for freight and material for the installation of such part; in addition, the Company's obligation shall be limited to reimbursement for normal labor on such parts.

Perfect Fry, Inc. agrees to pay the Authorized Service and Parts Distributor, for any labor and material required to repair or replace, at the Company's option, any part which may fail due to defects in material or workmanship during the above general warranty period.

ADDITIONAL PART ONLY WARRANTY

After the end of the above general warranty, the computer is warranted to be free of defects for an additional one (1) year. This additional warranty only covers the cost of the part. Customer is responsible for all labor and shipping costs during this warranty period.

HOW TO KEEP YOUR WARRANTY IN FORCE

- Make sure any shipping damages are reported immediately. Damages of this nature are the responsibility of the carrier and must be reported by the receiver.
- Install the appliance properly. This is the responsibility of the installer and the procedures are outlined in the manual.
- Register your equipment at www.perfectfry.com. This is necessary to start your warranty and to obtain the unlock code for the computer. The unlock code will be sent via email.
- Do not install the appliance in a home or residence.
- Maintain the appliance properly. This is the responsibility of the purchaser of the appliance and the procedures are outlined in the manual.
- Replace the air filter at regular intervals to prevent filter saturation. Record when the air filter is replaced in the Installation & Operations Manual. Also regularly inspect the door gasket for gaps, cracks and tears. Failure to do so could result in a non-warranty main fan failure due to grease build up.
- Adjustments, such as calibration, leveling, tightening of fasteners or plumbing or electrical connections normally associated with initial installation are outlined in the manual and are not covered under warranty.
- Damages as a result of fire, flood or other acts of God are not covered under this warranty.
- Use the appliance for what it is intended. If the appliance is used for a purpose other than for which it was intended or designed, resulting damages are not covered under the warranty.
- Make sure that the appliance has the correct voltage. If a failure is due to incorrect or erratic voltage, these damages are not covered under the warranty.
- Do not materially alter or modify the appliance.
- Do not obliterate, remove or alter the serial number rating plate.

- Use only Genuine OEM parts from Perfect Fry or its Authorized Parts and Service Distributors. Repairs are not covered by the warranty if non-OEM parts or non-Authorized Parts and Service Distributors are used.
- Failures that are not attributable to a defect in materials or workmanship are not covered.

This warranty specifically excludes parts which wear or would be replaced under normal usage, including, but not limited to, electric lamps, fuses, interior or exterior finishes, filters and gaskets.

LIMITS TO THE WARRANTY

Charges for mileage over one hundred (100) miles and travel time over two (2) hours from the Authorized Service and Parts Distributor are not covered under this warranty. Extended mileage charges are the responsibility of the individual or firm requesting these services.

If any oral statements have been made regarding the appliance, these statements do not constitute warranties and are not part of the contract of sale. This limited warranty constitutes the complete, final and exclusive statement with regard to warranties.

THIS LIMITED WARRANTY IS EXCLUSIVE AND IS IN LIEU OF ALL OTHER WARRANTIES WHETHER WRITTEN, ORAL OR IMPLIED, INCLUDING, BUT NOT LIMITED TO ANY WARRANTY OF MERCHANTABILITY OR FITNESS FOR A PARTICULAR PURPOSE OR WARRANTY AGAINST LATENT DEFECTS.

LIMITATIONS OF LIABILITY

In the event of a warranty or other claim, the sole obligation of Perfect Fry will be limited to the repair or replacement, at the Company's discretion, of the appliance or the component part. This repair or replacement will be at the expense of Perfect Fry except as limited by this warranty statement. Any repair or replacement under this warranty does not constitute an extension in time to the original warranty. Parts covered under this warranty will be repaired or replaced, at the Company's discretion, with new or functionally operative parts. The liability of Perfect Fry on any claim of any kind, including claims based on warranty, express or implied contract, negligence, strict liability or any other legal theories will be limited to the repair or replacement of the appliance. This liability will not include, and the purchaser specifically renounces any right to recover special, incidental, consequential or other damages of any kind, including, but not limited to, injuries to persons, damage to property, loss of profits or anticipated loss of the use of this appliance.

If any provision of this warranty is unenforceable under the law of any jurisdiction, that provision only will be inapplicable there, and the remainder of the warranty will remain unaffected.

The maximum exclusion or limitation allowed by law will be substituted for the unenforceable provision.

HOW TO OBTAIN WARRANTY SERVICE

Direct your claim to the Perfect Fry Authorized Service and Parts Distributor, found at <http://perfectfry.com/servicemap.aspx>, closest to you giving complete model and serial number, voltage and description of the problem. Proof of the date of installation and/or the sales slip may also be required. If there are questions about this procedure, write the National Service Manager, Perfect Fry, 42 Allen Martin Drive, Essex Junction, VT 05452. USA

This warranty gives you certain specific legal rights; you may have other rights which vary from state to state.

ORIGINAL STANDARD EQUIPMENT LIMITED WARRANTY

INTERNATIONAL UNITS

Effective January 1, 2018, Serial Number E18AA000000

WARRANTY

1 Year Parts

During the first year after purchase, all parts of the fryer which prove to be defective in materials or workmanship will be replaced free of charge (parts only).

2 Years Electronics:

During the first 2 years after purchase, if the electronics module proves to be defective in materials or workmanship, it will be replaced free of charge (parts only).

TERMS OF WARRANTY

1. Perfect Fry Company LLC warrants this fryer to be free from defects in materials and workmanship and will repair or replace it at Perfect Fry Company LLC's option for a period of one year after purchase providing the purchaser follows the manufacturer's recommended procedures for operation and maintenance contained in this manual. Perfect Fry Company LLC shall not be liable for injury or damage to property other than this fryer.
2. The warranty applies to materials at the factory for one year (2 years electronics) from date of purchase. The warranty does not include materials and labor employed in cleaning the fryer. Any and all transportation and shipping charges and expenses are the responsibility of the Purchaser. The warranty card must be completed and registered with Perfect Fry Company LLC. within 30 days of purchase to validate the warranty. The warranty will cease to exist if maintenance has not been performed according to the manufacturer's instructions. This warranty does not cover damage arising from or caused by improper maintenance, directly or indirectly, transportation, accident, misuse, improper installation, fire, flood, or acts of God. Parts repaired or replaced under this warranty are warranted throughout the remainder of the original warranty period only. The warranty does not apply to parts and service supplied or obtained from other than Perfect Fry or its authorized distributors.
3. Other than the warranty expressed in clause 1) hereof, Perfect Fry Company LLC expressly disclaims all conditions and warranties, express or implied, including, without limitation, the implied warranties of merchantability and fitness for a particular purpose. Perfect Fry shall not be responsible for, nor does this warranty extend to, any consequential or incidental damages or expenses of any kind or nature, regardless of the cause thereof or any knowledge which Perfect Fry may have regarding the probability of the occurrence of such damages or expenses including, without limitation, injury to persons or property, loss of life, loss of use of the products, lost goodwill, loss of income, lost resale profits, work stoppage, impairment of other goods, breach of contract, negligence or such other actions as may be deemed or alleged to be the cause of a loss or damage.