



Air Curtain Owner's Manual

Models:
CED & CED-E | BCE, BCT, RBT | ETD & ETD-E
ETA & ETA-E



IMPORTANT!

- 1. CHECK FOR DAMAGE:** When you receive your air curtain, immediately check for visible or concealed damage. Claims should be made immediately to the transportation company. Powered Aire will not be liable for damage claims submitted late.
- 2. LOCATE AND RETAIN THE SERIAL NUMBER:** The unit's serial number is necessary to request technical support, order replacement parts or to acquire a wiring diagram. The serial number is located on a silver sticker located on the right side end cap when facing the front of the air curtain.

For PARTS, TECHNICAL SUPPORT or INFORMATION
call: 1-888-321-2473



Trained and experienced mechanic/electrician required for installation.

Powered Aire will not be responsible for misplaced switches.

Please review the following instructions for unpacking your air curtain and preparing it for installation.



- 1.** Remove shrink-wrap and remove wood slats from top and sides of crate.

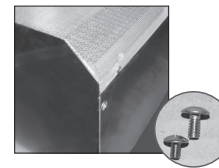

- 2.** Using a Phillips head screwdriver, unscrew the truss head screws that hold intake screen in place. Set aside screen and screws for later use. Remove filter (if supplied).

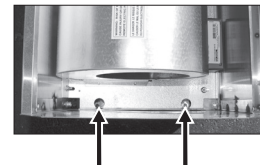

- 3.** The air curtain is lagged to the bottom of the crate frame. Use a 3/8" socket with extension and remove the 4 lag screws (one in each corner) that attach the air curtain to the skid. Unit is now ready for installation. Lag screw holes are used to bolt the air curtain to the wall. (Caution - Do NOT grasp by blower wheels. They will bend and throw wheels out of balance, affecting safety and performance of air curtain).

- 4.** Replace the intake screen and filter (if provided) when installation is complete.

Location of Remote Switches

If remote switches are supplied with the air curtain they are shipped in one of the following locations:

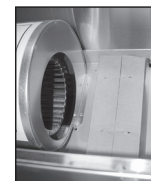

In a box inside the unit.

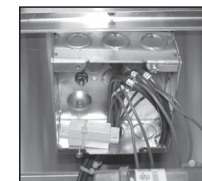

Inside the junction box.



Inside the Control Panel enclosure (if supplied).

INSTALLATION OPTIONS

*Threaded rod provided by others; angle brackets & strut optional for purchase.

**All hardware and brackets must be of sufficient strength to safely support air curtain.

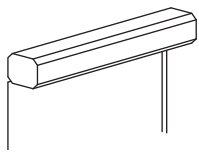

Wall Mount - Back side of air curtain has 4 mounting holes capable of accepting four 3/8 mounting bolts or lags, with washers (use these holes only for mounting). Mark and pre-drill mounting surface accurately. A long extension and ratchet will negate the need to remove the motor/blower plate when installing. Mounting bolts or lags of sufficient size and strength should be installed and tightened through the four 7/8 inch holes in motor/blower plate.

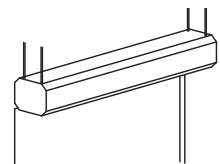

Top Mount - Unit has four 3/8-16 threaded inserts for installing one end of threaded rods. The other ends of the threaded rods can be attached to the ceiling. Threaded rod should not extend more than 3/4 inch into air curtain.

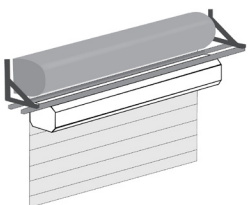

Under Door Canister - If this is a new door, the canister can be raised above the top of the opening so that the air curtain installs beneath it.

NOTE:

Order air curtain wide enough to clear door track system.

-or-

Struts can be added to the top of the air curtain to extend the top mounting points past the canister and brackets added outside the canister (pictured above).

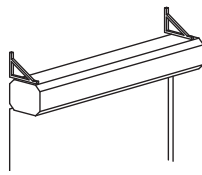

Angle Brackets - Angle brackets (also called knee or L-brackets) can be flush to the wall or constructed to account for a projection from the wall. For proper sizing provide distance from wall to back of air curtain. Max. offset of 20".

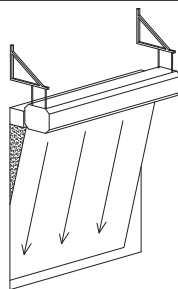

In Front of Door Canister or Other Obstruction - Mounting brackets are attached to the wall above the obstruction. The air curtain is installed in front of the obstruction utilizing threaded rod from the unit to the brackets or connected directly to the brackets. Moving the air curtain away from the wall will create triangular gaps on both sides where outside air may enter. For maximum effectiveness gaps can be sealed off with a permanent barrier or PVC strips to prevent air from entering. See illustration below.

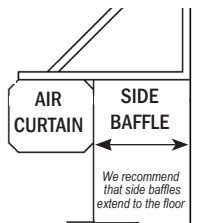

Side Extension Brackets - Extension brackets bolt on to the back of the unit, utilizing the 4 original mounting holes, and allowing for external mounting of unit to wall. Brackets have elongated mounting slots that extend the mounting width by 2 1/2 to 3 1/2 inches.

MB123 Quick Mounting Plate -- The plate has a universal hole pattern that attaches to the wall and a bar that is attached to the air curtain. The back side of the air curtain has four standard mounting holes.

The MB123 can be used when the holes do not line up with wall studs or other structural supports.



INSTALLATION NOTE

The bottom of the air curtain should be flush with the top of the opening if possible. If not and the air curtain has to be raised, the following applies: **For every one inch the bottom of the air curtain is mounted above the door header, the back side of the air curtain should be moved away from the wall 1/2 inch.**

INCORRECT Installation

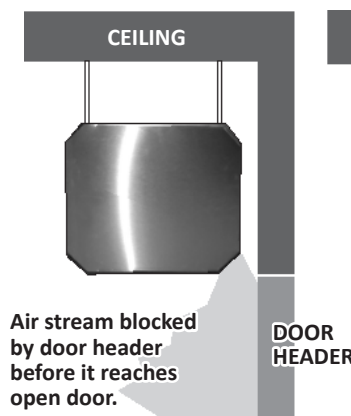

Air stream blocked by door header before it reaches open door.

CORRECT Installation

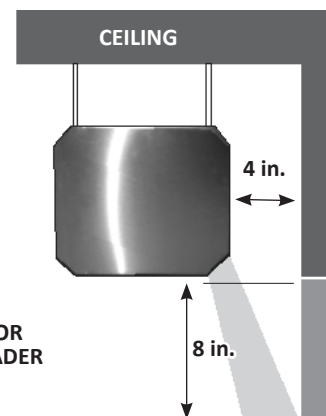

Air stream has a clear path to the open doorway.

CLEARANCES

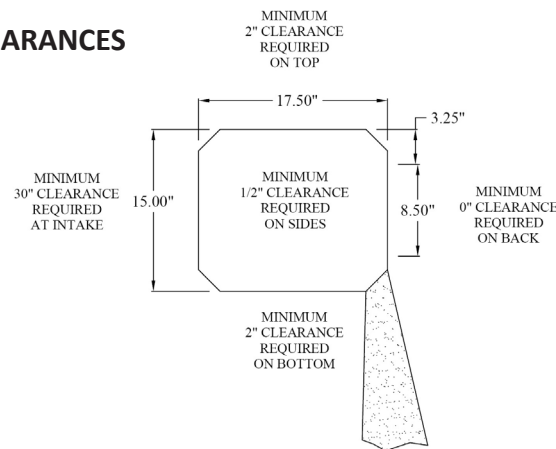

Electrical Installation:

Units must be field wired in accordance with all local and national electric codes, including wire size and materials.

NOTE: For optimum use for both climate control and insect control the air curtain should be installed on the inside of the door opening. If the application is strictly for insect control, the unit may be installed on the exterior of the opening.

OUTDOOR MOUNTING

Models BCE, BCT and RBT are ETL listed for outdoor mounting if required for insect control. Special steps are taken to enable the air curtain to operate in an outside environment, so this feature must be requested when ordering.



MAINTENANCE

*Before any internal maintenance is performed be sure all power to unit is disconnected and locked out.

- Periodically clean return air screen and re-cleanable filter (if equipped). The interval in between cleanings will vary per location depending on the amount of particles in the air. The holes in the screen must be free from obstructions to ensure that the blowers can get enough air to function properly. To clean filter, remove screws and remove screen. Remove filter and simply flush with hot water or steam. Filters are made of rustproof aluminum or galvanized steel. After cleaning, allow the filter to dry before returning it to the unit.
- For units with hot water or steam coil, while cleaning screens and/or filters, visually inspect the heat exchanger fins to ensure they are not clogged up or damaged.
- While doing routine maintenance, verify that the discharge steering vanes are adjusted properly. The steering vanes come pre-set from the factory and will not need adjusted in most cases. In some cases of extreme conditions such as that of high winds, the steering vanes can be adjusted to point further towards the outside to counteract the wind. See Air Directional Adjustment below.

AIR DIRECTIONAL ADJUSTMENT:

Air curtain comes equipped with a steering vane in the discharge to allow for the outward adjustment of the discharge air direction. To adjust, first wrap a rag around the vane so it is not scratched. Grip the vane near the end on one side with a pair of channel locks and rotate it in the direction that you want the air to flow. Repeat for the other side. Periodic cleaning of the steering vane may be required. To clean it just wipe it down with a damp rag.

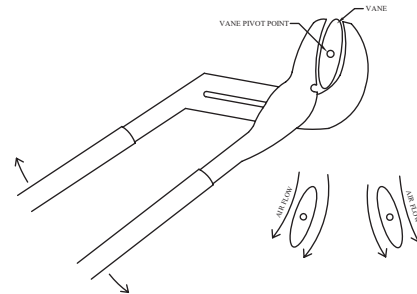

- Periodically do a visual inspection on the unit to ensure that the unit is not damaged and is operating properly with all motors spinning.
- Most commercial units have single phase motors that are permanently lubricated, so there are not any fittings that need greased.

*Note that the air curtain blowers are direct drive so there are no belts to maintain.

NOTE: If motor/blower plate has to be removed, the junction box inside the unit must be removed along with any electrical switches that may be in the way. The electrical switches have a lever that slides in one direction to release the switch contacts from the switch body. All wires will then stay intact for easy installation when replacing blower plate. Remove 7/16 whizlock nuts holding plate in place, and slide plate out, rotating top portion of plate so it comes out first. Remember when installing plate to put bottom of plate in first and rotate top in last. NOTE: For wider units the rivets attaching the center straps will have to be drilled out.

RETURN POLICY

- For all warranty issues contact factory at 724-985-4183.
- All returns must be approved in advance and accompanied by an RGA number or will not be accepted.
- Once units have been installed no returns will be allowed.
- Units that are returned damaged will not be accepted and full payment will be required.
- No returns will be allowed after 10 working days from shipment.
- Contact factory for Restocking Fee Schedule.

TROUBLESHOOTING - UNHEATED UNITS

* REPAIRS SHOULD BE PERFORMED BY A MECHANIC / ELECTRICIAN

SYMPTOMS	POSSIBLE CAUSES	CHECK/REMEDIES	
NON-OPERATIONAL	Main circuit breaker or disconnect is in OFF position.	Move switch to ON position or reset.	
	Loose electrical connection.	Check / tighten connection.	
	Fuse blown.	Replace fuse.	
MINIMAL / NO AIR	Intake screen and filter clogged.	Remove, clean and / or replace.	
	Air intake restricted.	Remove obstruction or move air curtain.	
	Fan not rotating.	Affix set screw(s) to shaft.	
	Air discharge inadequate.	Obstruction in discharge path (i.e. door headers, automatic door openers, etc.) Move air curtain.	
	Air discharge deflecting into wall.	For every 1 inch air curtain is mounted above the door header, air curtain should be moved away from the wall ½ inch.	
	Negative air pressure.	Equalize building pressure.	
	Multiple motor units: (only) one motor not operating.	Repair or replace motor.	
	EXCESSIVE BLOWER NOISE/ VIBRATION	Blower wheel loose on motor shaft.	Tighten set screw(s).
		Air intake vibration.	Tighten air intake screws.
Blower wheel dirty.		Remove and clean.	
	Damaged blower or unbalanced wheel.	Repair or replace.	
	Motor being worn.	Replace motor.	
	Fan hitting / rubbing fan housing.	Motor shaft bent. Repair or replace. Free housing from fan's path.	
ELECTRIC CONTROLS NOT FUNCTIONING	Switch in OFF position.	Move switch to ON position.	
	Door switch won't turn unit on/off when used in conjunction with Hand/Off/Automatic switch.	Move switch to AUTOMATIC position. Check wiring.	
	Improperly wired.	Check and repair.	
	Faulty switch.	Repair or replace.	
	EXCESSIVE AIR SPILL TO OUTSIDE OR INSIDE.	Nozzle angle too great.	Optimum angle setting is 15 degrees towards outside.

TROUBLESHOOTING - ELECTRICALLY HEATED UNITS

* REPAIRS SHOULD BE PERFORMED BY A MECHANIC / ELECTRICIAN

SYMPTOMS	POSSIBLE CAUSES	CHECK/REMEDIES
EXCESSIVE HEAT	Not enough air over electric heating coil.	See MINIMAL / NO AIR
	Improper voltage.	Supply voltage that unit requires.
	Thermostat setting is too high.	Switch to a lower temperature setting.
NO HEAT / NOT ENOUGH HEAT	Time delay is improperly wired.	Blown out, replace.
	Heat switch is in OFF position.	Rotate to ON position.
	Heat switch is in ON position.	Check wiring. Replace switch or contactor.
	Coil(s) burned out.	Replace.
	Heaters glowing red and thermal cut outs activating	Not enough air over coil. See MINIMAL / NO AIR
	Thermostat improperly set.	Set to desired temperature.
	Heater contactor not functioning.	Repair or replace.
	Improperly wired.	Check and adjust.
	Ambient temperature.	Units are recommended to have a minimum of 66 degrees intake air.

Replacement Parts Models: CED & CED-E | BCE, BCT, RBT | ETD & ETD-E ETA & ETA-E

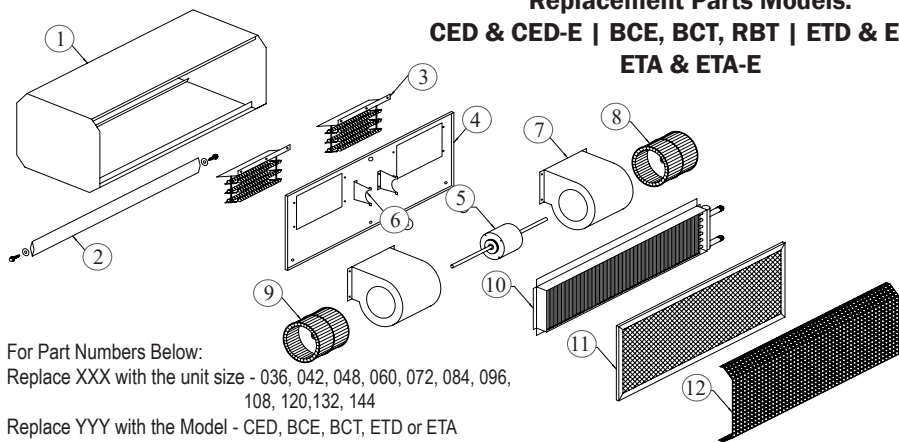

For Part Numbers Below:
Replace XXX with the unit size - 036, 042, 048, 060, 072, 084, 096,
108, 120, 132, 144
Replace YYY with the Model - CED, BCE, BCT, ETD or ETA

ITEM	DESCRIPTION	PART#	ITEM	DESCRIPTION	PART#
1	OUTER CASE	CMCAS-XXX	5	MOTOR (120 Volt, Single Phase)	7124-120-YYY
2	STEERING VANE	CMSV-XXX	5	MOTOR (208/230 Volt, Single Phase)	7124-230-YYY
3	ELECTRIC HEATER (208 VOLT, Double Coil)	21-3307-00	5	MOTOR (480 Volt, Single Phase)	7124-480-YYY
3	ELECTRIC HEATER (240 VOLT, Double Coil)	21-3307-01	5	MOTOR (575 Volt, Single Phase)	7124-575-YYY
3	ELECTRIC HEATER (480 VOLT, Double Coil)	21-3307-02	6	MOTOR MOUNT (For Single Phase Motor)	2120-051
3	ELECTRIC HEATER (575 VOLT, Double Coil)	21-3307-03	7	BLOWER HOUSING	CMBLR-HS
3	ELECTRIC HEATER (208 VOLT, Single Coil)	21-3317-00	8	BLOWER WHEEL (RIGHT)	CMBLR-WH-R
3	ELECTRIC HEATER (240 VOLT, Single Coil)	21-3317-01	9	BLOWER WHEEL (LEFT)	CMBLR-WH-L
3	ELECTRIC HEATER (480 VOLT, Single Coil)	21-3317-02	10	HOT WATER / STEAM COIL	CONSULT FACTORY
3	ELECTRIC HEATER (575 VOLT, Single Coil)	21-3317-03	11	FILTER	CMFLT-XXX

LIMITED WARRANTY

Scope of Warranty: Powered Aire's products are warranted against defects in Powered Aire workmanship and materials. Powered Aire Inc. and its employees are committed to providing our customers with the best designed and manufactured Air Curtains / Door Heaters. We welcome comments and questions regarding our products. Please contact us at Powered Aire Inc. Phone: 724-588-3305.

Warranty Period: Powered Aire unheated air curtains are warranted for 24 months from the date of shipment. All other Powered Aire heated air curtains are warranted for 18 months from the date of shipment. All warranty claims must be submitted to Powered Aire prior to the expiration date of the warranty period. *All warranties cover parts only. If Powered Aire does not supply the controls for the air curtain, the unit will not be warranted.*

Procedure to Receive Warranty Service: Customer should take or ship prepaid the Powered Aire product requiring warranty service to Powered Aire. Contact the Home Office for authorization number. Include an explanation of the defect or problem, a description of the way in which the Powered Aire product is used, and your name, telephone number and address. Tag shipment with authorization number. **Repair by Other than Powered Aire:** Customers who are unable to take or ship the Powered Aire product to the factory, should contact the home office. A repair by anyone other than Powered Aire authorized personnel must be approved in advance by Powered Aire. **Repairs Outside the Scope of Warranty:** Problems with Powered Aire products can be due to improper maintenance, faulty installation, non Powered Aire additions or modifications, or other problems not due to defects in Powered Aire workmanship or materials. If the authorized Powered Aire Service Company determines that the problem with a Powered Aire product is not due to defects in Powered Aire workmanship or materials, then the customer will be responsible for the cost of any necessary repairs. Customers not satisfied with a determination that a problem is outside of warranty coverage should contact the Powered Aire Home Office.

Repairs or Replacement Within the Scope of the Warranty: If a Powered Aire product is defective due to Powered Aire workmanship or materials and the defect occurs during the warranty period, then Powered Aire will either repair the product or replace it with a new one, whichever Powered Aire believes to be appropriate under the circumstances. Powered Aire is not responsible for the removal and shipping of the Powered Aire product to the home office, the reinstallation of Powered Aire product upon its return to the customer, or any incidental or consequential damages resulting from the defect, removal, reinstallation, shipment or otherwise.

Intended Use: Powered Aire products are designed for industrial / commercial applications.

Product Specifications: All product specifications, applications and other information provided in Powered Aire's catalog and publications are subject to correction and change without notice and should be confirmed by the Home Office. **Extended Warranties:** Extended warranties are available. They will be negotiated individually. Extended warranties are subject to the terms and procedures of this Limited Warranty and Service Policy as modified by the additional terms of the extended warranty. **No Other Warranties and Liability Limitation:** This Limited Warranty represents Powered Aire's sole and exclusive warranty obligation with respect to Powered Aire products. Powered Aire's liability to customer or any other person shall not exceed the Powered Aire's sales price of the applicable Powered Aire Product. Powered Aire disclaims all other expenses and implied warranties including the implied warranties of fitness for a particular purpose and merchantability.

109 Mortensen Rd., Greenville, PA 16125
Phone: 724-588-3305 Toll-Free: 1-888-321-2473
www.poweredaire.com