

iCombi[®] Pro

Original instructions for use



 **WARNING**

FOR YOUR SAFETY

Do not store or use gasoline or other flammable vapours and liquids in the vicinity of this or any other appliance.

 **WARNING**

Improper installation, adjustment, alteration, service or maintenance can cause property damage, injury or death
Read the installation, operating and maintenance instructions thoroughly before installing or servicing this equipment.

NOTE

How to respond if you smell gas:

- Do not switch any lights or equipment on or off. Do not unplug anything. Do not use any landlines or mobile phones. They could create sparks and increase the risk of explosion.
- Open the doors and windows to ventilate the room with fresh air. Do not switch on recirculation hoods or ventilators in order to ventilate the room. They could create sparks and increase the risk of explosion.
- Close the locking mechanism on the gas line.
- Leave the building and contact the fire department or your gas company.

Contents

1 Introduction	9
1.1 Unit help function	9
1.2 Product liability	9
1.3 Target audience	9
1.4 Intended use	9
1.5 Using these instructions for use	9
1.5.1 Explanation of symbols	9
1.5.2 Explanation of pictograms	10
1.5.3 Explanation of warnings	10
1.5.4 Illustrations	10
1.5.5 Technical changes	10
2 The iCombi Pro	11
3 General safety information	12
3.1 Safety information for units with gas line connections	13
3.2 Personal protective equipment	13
4 Working with the unit	14
4.1 Initial start-up	14
4.2 Switching the unit on and off	14
4.3 Home screen	15
4.3.1 Date, time, status	16
4.3.2 Help function	16
4.4 Interacting with the unit	16
4.4.1 Gestures	16
4.4.2 Central selection knob	17
4.5 Maximum load capacities	17
4.6 Opening and shutting the cooking cabinet door	18
4.7 Load unit	18
4.8 Inserting core temperature probes	19
4.9 Using the hand shower	22
4.10 Integrated fat drain	23
5 Manual cooking	25
5.1 Fine-tuning your results	25
5.1.1 cooking parameter	25
5.1.2 Additional functions	26
5.1.3 Prompts and information	27
5.2 Steam	27
5.2.1 Cooking cabinet climate and temperature range	27
5.2.2 Cooking with steam	27
5.3 combi-steam	28
5.3.1 Cooking cabinet climate and temperature range	28
5.3.2 Cooking in Combi Steam mode	28
5.4 convection	29

5.4.1	Cooking cabinet climate and temperature range.....	29
5.4.2	Cooking with hot air.....	29
5.5	Cancel manual cooking	30
6	Sous-vide cooking	31
6.1	Sous-vide cooking paths.....	31
7	Pasteurizing	32
7.1	Pasteurization cooking paths.....	32
8	Smoking	33
8.1	Smoking cooking paths	33
9	Low temperature cooking	34
10	Finishing.....	35
10.1	Set à la carte plate weight	35
10.2	Setting the banqueting plate weight	35
11	iProductionManager	37
11.1	Creating manual tickets	37
11.2	Ticket board	38
11.2.1	Adding intelligent cooking paths.....	38
11.2.2	Adding programs and shopping carts	38
11.2.3	Ticket board editor	39
11.3	Timer	39
11.4	Placing tickets.....	40
11.4.1	Combination check	41
11.4.2	Positioning logic.....	41
11.4.3	Close planning gaps.....	41
11.4.4	Time optimization	42
11.4.5	Energy optimization	43
11.5	Editing and deleting tickets	44
11.6	Target time cooking.....	44
11.7	Planning.....	44
11.7.1	Creating plans.....	45
11.7.2	Starting plans.....	46
12	Programming mode	47
12.1	Creating programs manually	47
12.2	Creating an intelligent program	49
12.3	Programming shopping carts	51
12.4	Editing and deleting programs	52
12.5	Starting programs and shopping carts.....	52
13	Programming mode – iCareSystem AutoDose	54
13.1	Create cleaning program (chemical reserves)	54
13.2	Editing and deleting programs (chemical reserves).....	55
14	Switching between operating modes.....	57
15	Settings	58

15.1	Favorites.....	58
15.2	Display	58
15.2.1	Language.....	58
15.2.2	Date and time	58
15.2.3	Setting the temperature format.....	59
15.2.4	Program view	59
15.3	Light.....	60
15.3.1	Display brightness.....	60
15.4	Sound	60
15.4.1	Master volume	60
15.4.2	Loading / action requests	61
15.4.3	Program step end.....	61
15.4.4	End of cooking time	61
15.4.5	Process canceled / error detected.....	62
15.5	Cooking system	62
15.5.1	Information on the unit type.....	62
15.5.2	Power usage	62
15.5.3	iProductionManager energy-saving mode.....	63
15.5.4	Screen lock	63
15.5.5	Demo mode	63
15.5.6	Power steam.....	63
15.5.7	Control nozzle	63
15.5.8	Watchdog	63
15.5.9	Danger	64
15.5.10	Empty steam generator.....	64
15.5.11	VarioSmoker.....	64
15.6	Cook.....	64
15.6.1	Primary national cuisine	64
15.6.2	Secondary national cuisine	64
15.6.3	A la carte plate weight.....	65
15.6.4	Banqueting plate weight	65
15.6.5	Number of racks	65
15.6.6	Order of racks.....	65
15.6.7	Load calculation for manual programs in iProductionManager.....	65
15.6.8	Hold time climate	65
15.6.9	iProductionManager 3D.....	66
15.7	Data management	66
15.7.1	Export all data.....	66
15.7.2	Cooking programs	67
15.7.3	User profiles.....	67
15.7.4	User images	67
15.7.5	Basic cooking system settings.....	68
15.7.6	HACCP data	68
15.7.7	Service	68
15.7.8	MyDisplay.....	69

15.8	Network settings.....	69
15.9	User profile.....	71
15.9.1	Activate profile.....	71
15.9.2	Edit profile.....	72
15.9.3	Add profile.....	74
15.9.4	Edit display.....	74
15.9.5	Create new screen.....	74
15.10	Service.....	75
15.10.1	Installed software version.....	75
15.10.2	Software update info.....	75
15.11	ConnectedCooking.....	75
16	Kitchen management.....	77
16.1	Hygiene management.....	77
16.1.1	Recorded HACCP data.....	77
16.1.2	Exporting HACCP data.....	77
16.1.3	Transmitting HACCP data to ConnectedCooking automatically.....	77
16.2	Connecting units to a network.....	77
16.2.1	Establish WLAN connection.....	78
16.2.2	Connecting the network cable.....	79
16.2.3	Establish network connection.....	79
16.3	ConnectedCooking.....	80
16.3.1	Connect the unit with ConnectedCooking.....	80
16.4	Run software update.....	81
17	Automatic cleaning - iCareSystem.....	82
17.1	General safety information.....	82
17.2	Cleaning modes.....	82
17.3	Cleaning programs.....	83
17.4	Cleaning and care status.....	83
17.5	Starting automatic cleaning.....	84
17.6	Canceling automatic cleaning.....	85
17.7	Forced cleaning after operating hours.....	85
17.8	Cleaning schedule.....	85
18	Automatic cleaning - iCareSystem AutoDose.....	87
18.1	General safety information.....	87
18.2	Cleaning modes.....	87
18.3	Cleaning programs.....	88
18.4	Cleaning, care and cleaner cartridge status.....	88
18.5	Replace cleaner cartridge.....	89
18.6	Starting automatic cleaning.....	91
18.7	Canceling automatic cleaning.....	91
18.8	Forced cleaning after operating hours.....	92
19	Care.....	93
19.1	General safety information.....	93
19.2	Care intervals.....	93

19.3	Care products	93
19.4	Cleaning the cooking cabinet door.....	94
19.5	Descaling the steam nozzle.....	95
19.6	Cleaning the air filter	95
19.7	Cleaning the hand shower	96
19.8	Cleaning the control panel	97
19.9	Cleaning accessories.....	97
19.10	Cleaning the drain ventilation pipe.....	98
20	Care - iCareSystem AutoDose	99
20.1	General safety information	99
20.2	Care products	99
20.3	Maintenance intervals for AutoDose	99
20.4	Cleaning the cooking cabinet door.....	100
20.5	Descaling the steam nozzle.....	101
20.6	Cleaning the air filter	102
20.7	Cleaning the hand shower	102
20.8	Cleaning the control panel	103
20.9	Cleaning accessories.....	103
20.10	Cleaning the drain ventilation pipe.....	104
21	Inspiration and help	105
21.1	search assistant	105
21.2	Unit help function	105
21.3	Telephone help	105
21.4	Service-related help.....	106
21.4.1	Transmitting service data to ConnectedCooking automatically	106
21.4.2	Querying service data	106
21.5	Problem resolution	106
21.5.1	Error messages heating steam generator	106
21.5.2	Error messages for gas units.....	107
21.5.3	Error messages heating hot air	107
21.5.4	Error messages humidity	108
21.5.5	iCareSystem error messages – cleaning	108
21.5.6	iCareSystem error messages – care	108
21.5.7	Notification centre	109
22	Maintenance.....	110
22.1	Replacing air filters.....	110
22.2	Replacing the cooking cabinet door seal	111
23	Transport	112
23.1	Transporting the unit.....	112
24	Decommissioning and disposal	114
24.1	Decommissioning.....	114
24.2	Disposal	114
25	Technical data	115

25.1	Units with electrical connections.....	115
25.2	Units with gas connections.....	115
25.3	Types and model names	115
25.4	115
25.5	Conformity	115
25.5.1	Units with electrical connections.....	115
25.5.2	Units with gas connections	116
26	Regulatory Information.....	117
	Directory of keywords.....	119

1 Introduction

Dear customer,

Congratulations on purchasing your new iCombi Pro. Read the operating instructions carefully prior to using your unit for the first time. The operating instructions are there to ensure that you use the unit safely. Keep these operating instructions in a place that is accessible at all times to anyone who will be using the unit.

The iCombi Pro is the most intelligent combi-steamer. It cooks a multitude of different dishes for 20 or several thousands of guests. Whether these are fish, meat, poultry, side dishes or baked goods, or whether they are fried, steamed, grilled or baked. Thanks to its cooking intelligence and its intelligent climate management, this is all done automatically, to the point, even with a maximum load.

We hope you enjoy using your iCombi Pro.

All the best from

RATIONAL AG

1.1 Unit help function

These instructions for use are loaded to your unit, along with numerous example applications from all over the world. More information on this function is available here: Unit help function [► 105]

1.2 Product liability

RATIONAL assumes no liability for damage occurring in connection with unauthorized technical modifications or improper use.

1.3 Target audience

This document is written for people working in professional kitchens and food-service operations.

The unit must not be used, cleaned, or maintained by:

- Persons with restricted physical, sensory, or mental faculties
- Persons with limited knowledge and experience
- Children

Children in the vicinity of the unit must be supervised at all times. Do not allow children to play with the unit.

1.4 Intended use

The iCombi Pro has been developed for the preparation of hot food.

This unit is only intended for commercial use, such as in restaurant kitchens, hospital food service operations, bakeries, or delis. Do not use this unit outdoors. This unit must not be used for continuous mass industrial food production.

All other usages of this cooking system are considered improper and dangerous. RATIONAL AG assumes no liability for consequences of improper use.

1.5 Using these instructions for use

1.5.1 Explanation of symbols

This document uses the following symbols to provide information and instructions for action:

- ✓ This symbol indicates prerequisites that must be met before you take a specific action.
 1. This symbol indicates an action you will need to take.
 - > This symbol indicates an intermediate result you can use to evaluate the results of a single action.
 - >> This symbol indicates an end result you can use to evaluate the results of a series of instructions.
 - This symbol is used for bullet points.
 - a. This symbol is used in lists.

1.5.2 Explanation of pictograms

The following pictograms are used in this document:

 Caution! Read the instructions for use before using the unit.

 General warning symbol

 Useful information to help you use your unit.

1.5.3 Explanation of warnings

The following warnings are used to advise you of potentially dangerous situations and how to avoid them.

DANGER

The word DANGER indicates a situation that will result in severe injuries or death.

WARNING

The word WARNING indicates a situation that could result in severe injuries or death.

CAUTION

The word CAUTION indicates a situation that could result in injuries.

NOTE

The word NOTE indicates a situation that could result in damage to the unit.

1.5.4 Illustrations

The illustrations in these instructions for use may deviate from the actual unit.

1.5.5 Technical changes

We reserve the right to make technical changes in the interest of progress.

2 The iCombi Pro



Model 20-half size



Model 20-full size

3 General safety information

This unit is constructed securely, and does not pose a danger when used normally and in accordance with specifications. These instructions for use describe proper procedures for using this unit.

- This unit should only be installed by your RATIONAL Service Partner.
- All maintenance on this unit should be performed by your RATIONAL Service Partner.
- To ensure that your cooking system remains in perfect condition, it must be serviced by an authorized RATIONAL Service Partner at least once per year.
- Do not modify the unit or the way your RATIONAL Service Partner has installed it.
- Do not remove the drain sieve.
- Do not use the cooking system if it is damaged in general, or if the connection cable is damaged. Damaged cooking systems are unsafe and could cause burns or other injuries.
- Do not use the unit if the glass on the cooking cabinet door is damaged. Contact your RATIONAL Service Partner and have the cooking cabinet door glass replaced.
- Never place objects on top of the device.
Do not place hot containers or containers of hot liquids on top of the cooking system.
- Never store flammable or combustible materials near the unit.
- Only use the cooking system at ambient temperatures between +41°F and +104°F.
- Avoid placing sources of heat near the unit, such as deep fryers or grills.
- While using the unit, keep the floor around it clean and dry.
- Regular training and safety instructions for operating personnel are essential to preventing accidents or damage to the cooking system.
- This cooking system must not be used by children or persons with reduced physical, sensory or mental capabilities, or by anyone lacking proper experience and/or knowledge, unless that person is made aware of the potential dangers of the cooking system, and remains under the supervision of someone who takes responsibility for safety. When supervising, please keep in mind that surfaces and accessories may be hot. Cleaning and user maintenance must not be performed by children, even when supervised

Safety instructions before use

- Make sure that the temperature of the unit is at least +41°F.
- Make sure that the air baffle in front of the fan is secure at the top and the bottom.
- When using the hinging rack or mobile oven rack, make sure to lock them in place.
- Make sure that the cooking cabinet is free of cleaner tab residue.
- If the unit has been inactive for a longer period of time, rinse out the hand shower with at least 2 1/2 gallons of water before using the unit again.
- When heating food in packaging, always use the settings specified by the packaging distributor.

Safety instructions during use

- To avoid scalding and burn injuries:
 - Exercise caution when opening the cooking cabinet door - Hot steam may escape.
 - Always wear personal protective equipment when removing anything from the hot cooking cabinet.
 - When the unit is in use, only touch the control panel and the cooking cabinet door grip. The external surfaces can heat up to temperatures exceeding 140°F.
 - Only slide containers of food into racks at levels you can see into. Otherwise, hot food can spill out when being unloaded from the unit.
- To avoid the risk of fire or explosion:
 - Do not use the cooking system to cook highly flammable liquids, e.g., wine or other alcoholic beverages. Flammable liquids can catch fire when evaporating.
 - When roasting or grilling, place a drip pan underneath the food to catch grease.
- To prevent equipment damage due to improper use of accessories:

- Only use original RATIONAL accessories.
- Only smoke food using the VarioSmoker.
- If there is food in the cooking cabinet that has already been brought up to serving temperature, do not load cold food into the cooking cabinet.
- Always use the manufacturer's cooking climate specifications when heating packaged food to serving temperature.

To avoid injury when working with transport trolleys, mobile racks, or mobile plate racks:

- Exercise caution when pushing transport trolleys, mobile racks, or mobile plate racks across uneven surfaces or thresholds, to prevent them from tipping.
- Activate locking brakes on transport trolleys, mobile racks, or mobile plate racks to keep them from rolling away on uneven floors.
- Before sliding a mobile rack or mobile plate rack into or out of the cooking system, secure the transport trolley to your cooking system.
- When moving the mobile rack, secure the container lock on the mobile rack and cover containers of hot food. Otherwise, hot food could splash out.

Safety instructions after use

- Clean the unit after each use.
- In order to prevent the cooking cabinet from corroding, leave the cooking cabinet door open a crack whenever the unit will not be in use for a longer period, including overnight.
- If the unit will not be in use for a longer period, cut off the building water, electric and gas lines to the unit.
- Empty the steam generator before transporting the unit, or when the unit will not be in use for a longer period.

3.1 Safety information for units with gas line connections

- To prevent fire risk:
 - If your cooking system is connected to a chimney, contact your gas technician regularly to have the cooking system's exhaust line cleaned. Always observe country-specific regulations in this regard.
 - Never place objects atop the exhaust pipes.
 - Keep the appliance area free and clear from combustibles
 - Gardez la zone d'exploitation de l'appareil libre et dégagée de tout combustible.
- To prevent fatal accidents:
 - If using your cooking system with a recirculating hood, always switch on the recirculating hood while the cooking system is in use. Otherwise, flammable gases could build up.
- How to respond if you smell gas:
 - Do not switch any lights or equipment on or off. Do not unplug anything. Do not use any landlines or mobile phones. They could create sparks and increase the risk of explosion.
 - Open the doors and windows to ventilate the room with fresh air. Do not switch on recirculating hoods or ventilators in order to ventilate the room. They could create sparks and increase the risk of explosion.
 - Close the shut-off mechanism of the gas line.
 - Leave the building and contact the fire department or your gas company.

3.2 Personal protective equipment

- Only use the unit when wearing clothing that will protect you against work-related accidents, especially due to heat, splashing hot liquids, or corrosive substances.
- Wear gloves that will provide reliable protection when handling hot or sharp-edged objects.
- When cleaning the unit, wear tight-fitting safety glasses and chemical protective gloves that will allow you to handle cleaning products safely.

4 Working with the unit

4.1 Initial start-up

When you start your unit for the first time, it will have already been properly installed by a RATIONAL Service Partner. The self-test will have been completed, so the unit will be ready for use. Information related to installation is available in the installation manual included in delivery.

Before working with the unit for the first time

1. Clean the unit and all accessories before initial use.

More information is available here: Care [▶ 93]

4.2 Switching the unit on and off

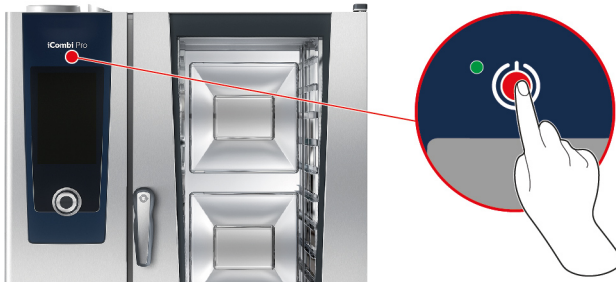

Switching the cooking system on

1. To switch the cooking system on, press and hold this button until the LED lights up green: 
 - > The cooking system will power on. The home screen [▶ 15] will appear.

Operation without water supply

NOTE

To prevent overheating and cooking system damage, operate the cooking system only with the water connected.

Without a water connection, the cooking system cannot be used in steam or combination mode. Only convection mode (dry heat) is available. The measures described are absolutely necessary to prevent overheating of the cooking system and possible damage.

Continuous operation without water is not possible.

When operating the cooking system without connecting it to a water supply, you will be prompted to pour 3 liters of water into the cooking cabinet. This symbol will appear in the footer:  Temporary operation without a water supply is possible under the following conditions:

1. Pour 3 liters of water into the bottom of the cooking cabinet to prevent the cooking system from overheating.
2. To confirm, press this button: 
3. After max. 5 hours of cooking system operation, cool it down to < 100°C.
4. Then pour another 3 liters of water into the cooking cabinet.
5. As soon as water is available again, start cleaning.

Switching the cooking system off

1. To switch the cooking system off, press and hold this button until the LED lights up orange: 
 - > A prompt will appear, asking if you really want to switch the cooking system off.
 2. To switch off the cooking system, swipe the bar to the right.
- >> The cooking system will power off.

4.3 Home screen

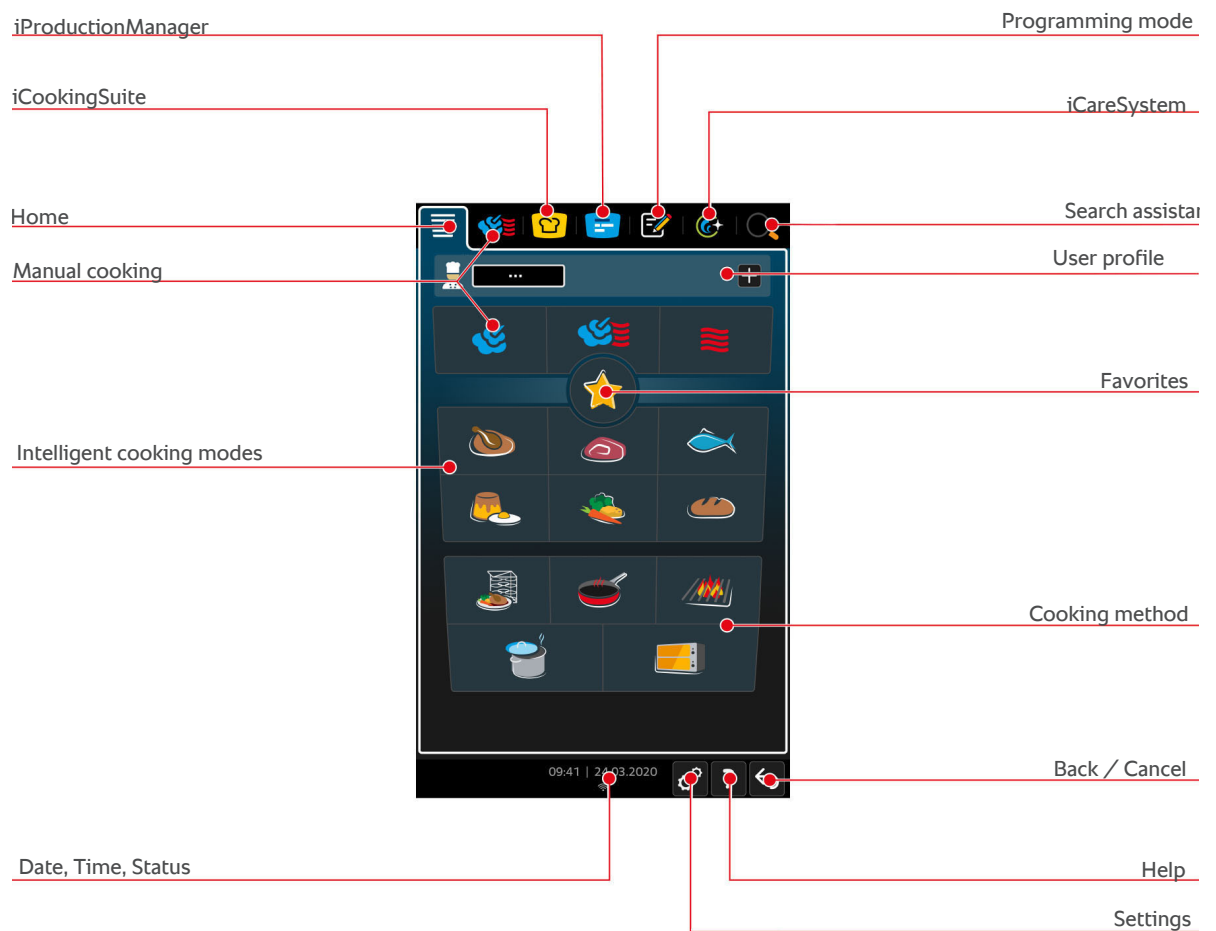

- iProductionManager [▶ 37]
- Intelligent cooking - iCookingSuite
- Home
Pressing this button will take you to the home screen.
- Manual operating modes [▶ 25]
- Favorites
- Intelligent cooking modes
Pressing one of these buttons will display all of the intelligent cooking paths assigned to that intelligent cooking mode.
- Cooking method
Pressing this button will display all of the intelligent cooking paths assigned to that cooking method.
- Programming mode [▶ 47]
- Automatic cleaning - iCareSystem [▶ 82]
- Date, time, status [▶ 16]
- Settings [▶ 58]
- Unit help function [▶ 105]
- Back / Cancel
Pressing this button will take you back to the previous screen. Press and hold this button in order to cancel the cooking process.

See also

 search assistant [▶ 105]

4.3.1 Date, time, status

The footer bar always shows the current date and time, as well as the status of the following ports and connections:



USB stick connected

This symbol indicates that there is a USB stick plugged into the cooking system.



Network connection

This symbol indicates that you are connected to the router but not to the Internet: 

This symbol indicates that your cooking system is connected to a LAN network. If a network error occurs, this symbol will be shown: 



WLAN connection

This symbol indicates that your cooking system is connected to a WLAN network. The connection quality is very good.

If connection quality decreases, these symbols will be shown: 

This symbol indicates that you are connected to the router but not to the Internet: 

If a connection error occurs, this symbol will be shown: 



Error message

This symbol indicates that an error message is being shown on the display.



ConnectedCooking connection

This symbol indicates that your cooking system is connected to ConnectedCooking. If your cooking system is not connected to ConnectedCooking, this symbol will be shown: 





Water connection

This symbol indicates that your cooking system is not connected to a water supply. When you switch the cooking system on, you will be prompted to pour 3 liters of water into the cooking cabinet.



Active energy optimization (optional connection to energy optimization system)

Your RATIONAL cooking system can optionally be equipped with an interface to an energy optimization system. If the energy optimization system restricts the power available to your cooking system, this symbol will appear in the display footer: . If the  symbol is not visible on the display, full mains power is available to the system.

4.3.2 Help function



Selecting help in the cooking system

Selecting the question mark icon will take you to the cooking system's built-in help function. It describes how to operate your cooking system in digital form. The help function is context-sensitive: information for the current screen content is always displayed first. The help function also offers detailed information and useful tips related to the individual cooking paths.

4.4 Interacting with the unit

4.4.1 Gestures

You can operate the display using a few simple gestures.



Pressing

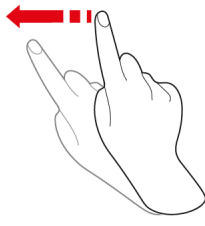

Swiping

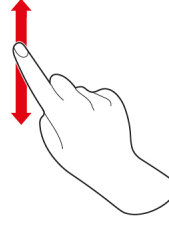

Scrolling

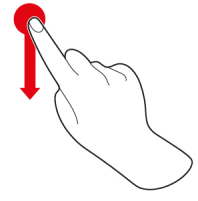

Drag-and-drop

4.4.2 Central selection knob

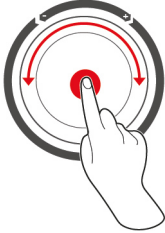

Instead of Gestures [▶ 16], you can adjust settings by turning the central selection knob. Press the central selection knob to confirm actions.

4.5 Maximum load capacities

NOTE

Damage to the unit due to overloading

Exceeding the maximum load capacity may damage the unit.

1. Never load the unit past the maximum capacity specified here.

Model	Max. load capacity [lb]	Max. load per tray
20-half size	198 lb	33 lb
20-full size	396 lb	66 lb

4.6 Opening and shutting the cooking cabinet door



Open cooking cabinet door

1. Turn the cooking cabinet door handle to the right.
2. If your unit is equipped with a security lock, first press the foot pedal, then turn the cooking cabinet door handle to the right, into the horizontal position.
3. Open the cooking cabinet door slowly. **⚠ CAUTION! Scalding hazard! When the unit is in operation, hot steam may billow out of the cooking cabinet.**

>> The fan wheel will be stopped.

Close cooking cabinet door

1. Close the cooking cabinet door, and then turn the handle to the left, into the vertical position.

4.7 Load unit

WARNING

Risk of injury due to broken glass

Always make sure that accessories are pushed all the way into the cooking system. Otherwise, the inside glass pane may break when the cooking cabinet door is closed, potentially leading to cut injuries.

NOTE

Protruding accessories

Always make sure that accessories are pushed all the way into the cooking system. Otherwise, the internal glass pane may break when the cooking cabinet door is closed.

1. Open the cooking cabinet door.
 - > The fan wheel brake will be activated, stopping the fan wheel.
2. Slide the food into the cooking system.
3. If grilling or roasting food, slide a container underneath the food in order to catch dripping fat. .

4. Close the cooking cabinet door. Make sure to close the cooking cabinet door all the way, and make sure that the handle is in the vertical position. **NOTE! If the cooking system has been turned off or disconnected from power for less than 15 minutes, the current process will resume where it left off.**

Rack levels above 1.60m



If your cooking system is installed such that the top rack level is more than 1.60m off the floor, the warning sign included in delivery must be affixed here.

4.8 Inserting core temperature probes

This section describes how to work with the core temperature probe, as well as how to work with the two optional, externally attachable core temperature probes. With a sous-vide USB core temperature probe, the temperature of sous-vide cooked food can be monitored without destroying the vacuum in the sous-vide bag. An external USB core probe can also be used if, for example, there is an equipment variant without an internal core temperature probe.

⚠ CAUTION

Hot core temperature probe

Touching the hot core temperature probe without protective gloves could result in burns.

1. Always wear gloves when working with hot core temperature probes.

⚠ CAUTION

Sharp core temperature probe

If you are not careful with the core temperature probe, you could injure yourself on the sharp tip. This applies in particular to the sous-vide USB core temperature probe.

1. Always wear gloves when working with hot core temperature probes.
2. After using the core temperature probe, return it to its holder.

NOTE**Core temperature probe hanging out of the cooking cabinet**

Failing to return the core temperature probe to its holder after use could result in damage to the core temperature probe.

1. After using the core temperature probe, return it to its holder.

**TIP**

- If you often prepare very thin or liquid food, we recommend using the optional positioning aid. Insert the core temperature probe into the positioning aid first, and then into the food.
- If the core temperature probe is hotter than the set core temperature, use the hand shower to cool the core temperature probe.

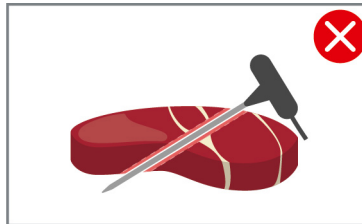
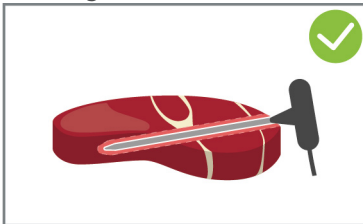
Meat, e.g., steak

1. Insert the core temperature probe into the food at an angle, all the way to the handle, so that the core temperature probe is as far down into the food as possible.

Large pieces of meat, e.g., roasts

1. Insert the core temperature probe into the thickest part of the meat, all the way to the handle.

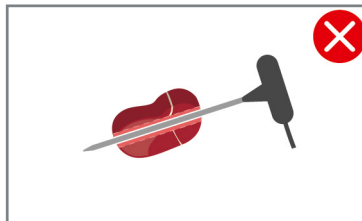
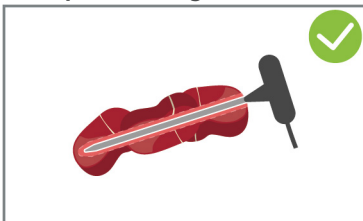
Small products, e.g., stew meat

1. Thread the core temperature probe through pieces of the food until the temperature probe is fully covered from tip to edge of handle.

Products of different sizes

1. Start by inserting the core temperature probe into the smallest piece.
2. Once that piece has reached the desired core temperature, remove the small pieces from the core temperature probe, and take them out of the cooking cabinet.
3. After that, insert the core temperature probe into a larger piece of food and use the **Reinsert** option to continue the cooking path .

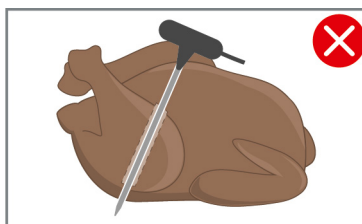
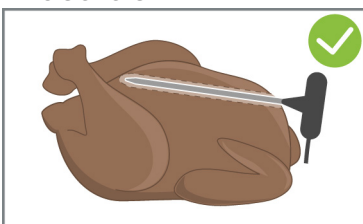
Whole chicken

1. Insert the core temperature probe into the thickest part of the breast, all the way to the handle. Avoid positioning it too close to the ribs.

Make sure that the tip of the core temperature probe is not poking through the abdominal cavity of the chicken.
Do not insert the core temperature probe into the thigh.

Fish fillets

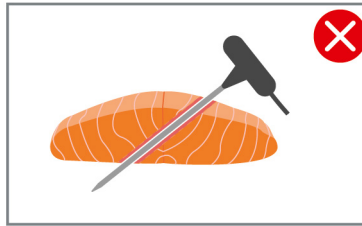
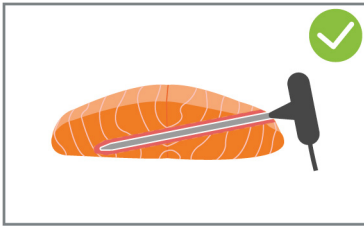

1. Insert the core temperature probe into the food at an angle, all the way to the handle, so that the core temperature probe is as far down into the food as possible.

Whole fish

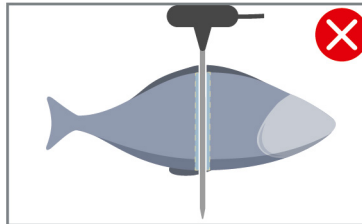
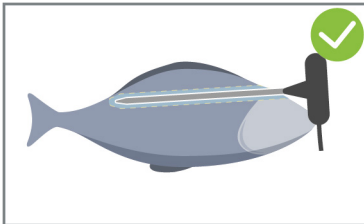

1. Insert the core temperature probe into the thickest part of the meat, all the way to the handle.
Make sure that the tip of the core temperature probe is not poking through the abdominal cavity of the fish.

Vegetables, e.g., potatoes

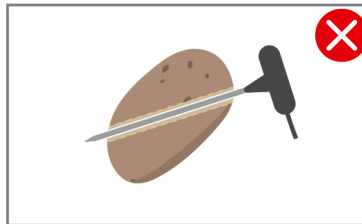
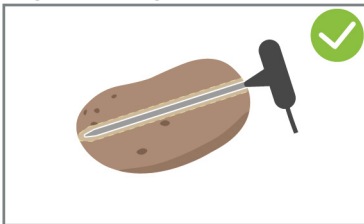

1. Insert the core temperature probe into the thickest part of the meat, all the way to the handle.

Soups, sauces, desserts

1. Place the core temperature probe into the Gastronorm container (hotel pan), so that the core temperature probe is completely immersed in the liquid.
2. When stirring the liquid, make sure that the core temperature probe remains in the Gastronorm container.

Baked goods

1. When preparing baked goods that rise a great deal during baking, insert the core temperature probe vertically into the center of the product.

Use the optionally available positioning aid.

Finishing with the mobile plate rack

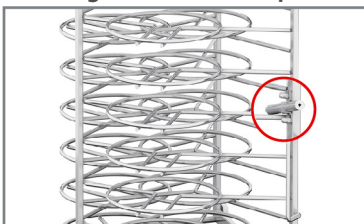

1. Insert the core temperature probe into the white ceramic tube on the mobile plate rack.

Core temperature probe not detected

✓ The display will show this symbol: 

1. Place the core temperature probe as described in these instructions for use.
2. Confirm the correction.



>> The cooking path will be implemented correctly. If you do not confirm the correction, the cooking path will be canceled and you will need to restart it. A few cooking paths, such as **low-temperature cooking**, will continue running despite the error.

Removing the core temperature probe

1. Once the food has reached your desired degree of doneness, remove the core temperature probe from the food, and then remove the food from the cooking cabinet.
2. Once you have cleaned the core temperature probe, insert it into the holder provided and then remove the food from the cooking cabinet.

4.9 Using the hand shower

Please note that you have the option of ordering a cooking system without a hand shower.

The hand shower has two spray modes: spray  (A) and jet  (B).

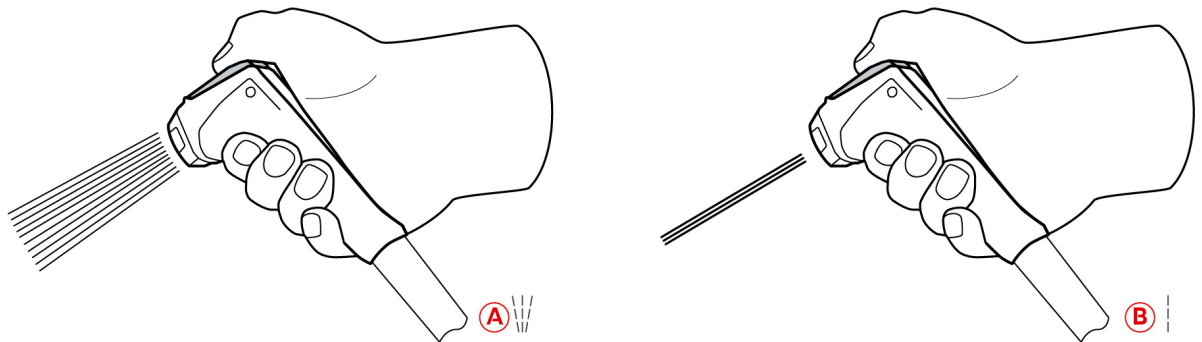

⚠ CAUTION

The hand shower water and the hand shower itself may reach temperatures exceeding 140°F.

Grasping heated parts or coming into contact with hot water may cause scalding injuries.

1. Always wear gloves when working with the hand shower.

⚠ CAUTION

Water line bacterial growth

Not using the hand shower every day can result in bacteria building up inside the water line.

1. Flush the hand shower with water for 10 seconds every morning and evening.

NOTE

Improper hand shower operation

Yanking the hand shower hose or extending it past the maximum available hose length can damage the hand shower's automatic return mechanism, after which the hand shower will no longer retract into the housing automatically.



1. Do not pull the hand shower out further than the hose length allows.

NOTE

The hand shower is not suitable for cooling the cooking cabinet.

Cooling the cooking cabinet with the hand shower could damage the cooking cabinet, the air baffle, or the glass on the cooking cabinet door.

1. Only cool the cooking cabinet using the cool-down function.

1. Pull the hand shower at least 8 in out of the park position.
2. Hold the hand shower hose firmly.
3. Turn the front part of the hand shower to select the desired spray mode.
 - Set the hand shower to  to select **jet** mode.
 - Set the hand shower to  to select the **spray** mode.

If you do not turn the front part of the hand shower to one of the two spray modes, water could drip out of the spray head.

1. Press the lever on the hand shower. The harder you press the lever, the stronger the spray will be.
2. After use, let the hand shower slowly retract into the housing. **⚠ CAUTION! Make sure that the hose of the hand shower is clean before letting it retract into the housing.**

4.10 Integrated fat drain

If your unit is equipped with an optional integrated fat drain, the dripping fat is collected in the cooking cabinet and fed into the grease drip container.



1	Ball valve handle	2	Drain pipe
3	Filler neck with bayonet lock	4	Fat collection container

1. Open the cooking cabinet door.
2. Remove the drain pipe plug.
3. Place the plug on the floor of the cooking cabinet next to the drain. The chain prevents the plug from being lost.
4. Place the grease drip pan in the cooking cabinet so that the opening of the grease drip pan is in the drain pipe.
5. Place a fat collection container (e.g. a canister) on the outside of the device under the drain.

6. Insert the filler neck of the integrated fat drain into the fat collection container.
 7. Connect the bayonet lock of the filler neck onto the drain.
 8. Lock the bayonet lock.
 9. Turn the handle of the ball valve into the horizontal position.
- >> The ball valve is open. Dripping fat can now be collected in the grease drip container.

Replacing the grease drip container

CAUTION

The outside of the device, the drain and the grease drip container can get very hot

You may get burned if you touch hot functional parts. Wear personal protective equipment when replacing the grease drip container.

1. When the grease drip container is full, turn the handle of the ball valve into the vertical position.
 - > The ball valve is closed.
2. Release the bayonet lock.
3. Replace the grease drip container.
4. Dispose of the grease correctly. **NOTE! Grease and other liquid substances collected in the grease drip container must be disposed of in accordance with the local regulations. Never dispose of grease by pouring it down the drain. Never use the fat collected in the fat collection container for cooking food or as a food itself.**

5 Manual cooking



With the manual modes, the iCombi Pro supports you in your personal craft.

By selecting this mode, you set the climate and select whether you want to cook the food in steam, with convection heat or with a combination of steam and convection. Then you set the cooking cabinet temperature, the air speed and cooking time and make all the necessary decisions yourself. This gives you control to ensure the food is cooked exactly as you want it.

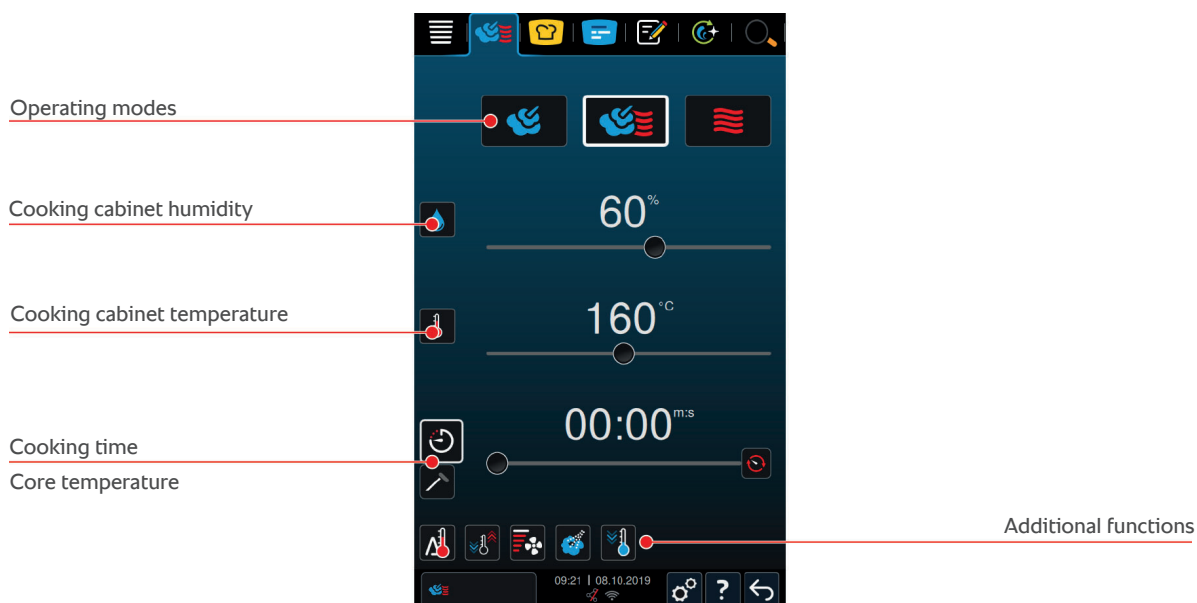

5.1 Fine-tuning your results

5.1.1 cooking parameter



Cooking cabinet temperature

Use this cooking parameter to adjust the cooking cabinet temperature. When you set the temperature to boiling temperature in **Steam** mode, this symbol is displayed: 

To view the current cooking cabinet temperature and humidity level:

1. Press and hold this button: 
 - > After 10 seconds, the current cooking cabinet temperature will be displayed.
2. Release the button to return to the set parameters.



Cooking cabinet humidity

Use this cooking parameter to adjust moisture levels inside the cooking cabinet.

- In **Steam** mode, the cooking cabinet humidity level is set to 100% and cannot be adjusted.
- In **Combi Steam** mode, the steam generator supplements the food's natural moisture. If the humidity exceeds the set humidity level, the cooking cabinet is dehumidified.
- In **Hot Air** mode, the steam generator does not supply additional moisture - all moisture comes from the food itself. If the humidity exceeds the set humidity level, the cooking cabinet is dehumidified.



Cooking time

Use this cooking parameter to set the cooking time for the food. If you set a cooking time, the **core temperature** parameter will no longer be available.

Alternatively, you can choose continuous mode to have your unit run uninterrupted using the settings you have chosen.

1. If you want to use your cooking system in continuous operation mode, either press  or slide the Cooking time control all the way to the right until the following message is displayed: **Continuous operation**



Core temperature

Use this cooking parameter to specify the core temperature you want the food to reach. Setting a core temperature will disable the **cooking time** option.

5.1.2 Additional functions



Delta-T cooking

NOTE

Please note that, when using Delta-T cooking with a cooking time, the core temperature probe must also be inserted into the product.

This additional function is used to maintain a constant differential between the cooking cabinet temperature and the core temperature. Raising the temperature of the cooking cabinet gradually, while maintaining a constant differential to the core temperature, helps cook the food slowly and gently. This option also minimizes cooking losses. You can set the differential anywhere between 50°F and 104°F. The smaller the difference between the cooking cabinet temperature and the core temperature, the more slowly and gently the food will cook. The greater the difference between the cooking cabinet temperature and the core temperature, the quicker the food will cook.

Either a target temperature or a desired cooking time can be set. If a target core temperature is set for the product, the cooking cabinet temperature will be regulated automatically based on the difference between the set delta temperature and the set core temperature. If a cooking time is set for the product, the cooking cabinet temperature will be regulated automatically based on the difference between the set delta temperature and the end of the set cooking time.



Create climate

This function adjusts the cooking cabinet temperature to fit the target temperature of a cooking path. For example, when you switch from a grilling application to a baking application, the cooking cabinet is cooled down. When you switch from baking to grilling, the cooking cabinet is heated up.



Fan speed

This additional function is used to set fan speed. The higher the level, the higher the fan speed. Choose a low level for small, delicate products.



Steam injection

With this additional function, water is sprayed from the steam nozzle onto the heating element during cooking. The steam condenses, moistening the surface of the food to optimize oven power and give you crisp crusts. The cooking cabinet temperature must be between 86 - 575°F.

1. Press and hold this button: 

>> Water will continue to spray out of the steam nozzle onto the fan for as long as you hold the button.



Cool down function

When you finish cooking at a high temperature and want to shift to a lower cooking temperature, you can use the cool down function to cool the cooking cabinet.

✓ Make sure the air baffle is secured correctly.

1. Press this button: 

> Set the temperature you want the cooking cabinet cooled to.

2. **⚠ WARNING! Scalding hazard! Hot steam may billow out of the cooking cabinet when you open the cooking cabinet door.** Open the cooking cabinet door.

>> **⚠ WARNING! Risk of injury! Opening the cooking cabinet door does not stop the fan. Do not touch the fan while it is in motion.** The fan speed will be increased. The cooking cabinet will cool down.

5.1.3 Prompts and information

During the cooking process, you may be shown the same prompts and information as you would during an intelligent cooking path.





5.2 Steam

5.2.1 Cooking cabinet climate and temperature range

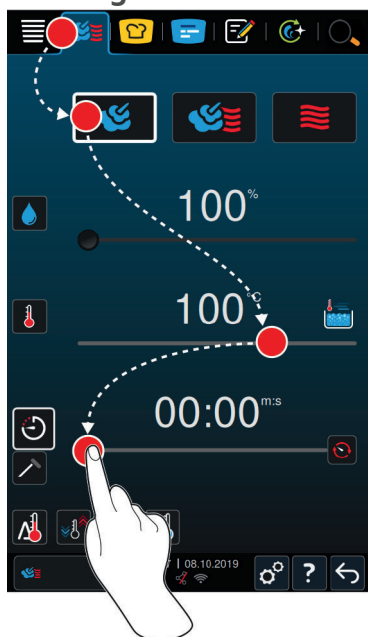
Cooking cabinet climate	cooking method	Cooking cabinet humidity	Cooking cabinet temperature
moist	<ul style="list-style-type: none"> ▪ Steam ▪ Stew ▪ Blanch ▪ Heat through ▪ Steaming rice ▪ Sous-vide cooking [▶ 31] ▪ Defrost ▪ Canning / Preserves 	100%	86 – 266°F

5.2.2 Cooking with steam



1. In the menu bar, press this button: 
2. Press this button: 
 - > The unit is preheating.
3. Set the cooking cabinet temperature you want.
4. To cook based on cooking time, press this button: 
5. Set the cooking time.
6. To cook using the core temperature probe, press this button: 
7. Set the core temperature.
 - > Once the set cooking cabinet temperature has been reached, you will be prompted to load the food.
8. Load product now.

>> The cooking path will continue. Once the cooking time has elapsed or the food has reached the set core temperature, a signal tone will sound, prompting you to check whether the food has reached your desired level of doneness.

5.3 combi-steam



5.3.1 Cooking cabinet climate and temperature range

Cooking cabinet climate	Cooking method	Cooking cabinet humidity	Cooking cabinet temperature
moist and hot	<ul style="list-style-type: none"> ▪ Bake ▪ Pan-fry side dishes 	0 – 100%	86–572°F

If the cooking cabinet temperature remains above 500°F for 30 minutes, it will automatically be reduced to 500°F if you do not work with the unit during that time. Taking action within those 30 minutes (opening the cooking cabinet door, for example) will reset the timer - the cooking cabinet temperature will be kept above 500°F for another 30 minutes.

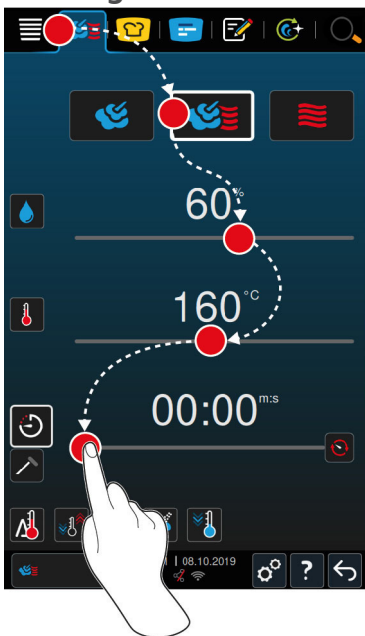
5.3.2 Cooking in Combi Steam mode



1. In the menu bar, press this button: 
 - > The cooking system will preheat to the set temperature.
 2. Set the desired cooking cabinet humidity to the exact percentage.
 3. Set the cooking cabinet temperature you want.
 4. Set the cooking time. 
 - > The cooking time will begin immediately when you press the dial or after five seconds with no additional input.
 5. To cook using the core temperature probe, press this button: 
 6. Set the core temperature.
 - > Once the set cooking cabinet temperature has been reached, you will be prompted to load the food.
 7. Load product now.
- >> The cooking path will continue. Once the cooking time has elapsed or the food has reached the set core temperature, a signal tone will sound, prompting you to check whether the food has reached your desired level of doneness.

5.4 convection





5.4.1 Cooking cabinet climate and temperature range

Cooking cabinet climate	cooking method	Cooking cabinet humidity	Cooking cabinet temperature
hot	<ul style="list-style-type: none"> ▪ Baking ▪ Pan-fry ▪ Grilling ▪ Deep-fry ▪ Browning ▪ Glazing 	0 – 100%	85 – 575°F

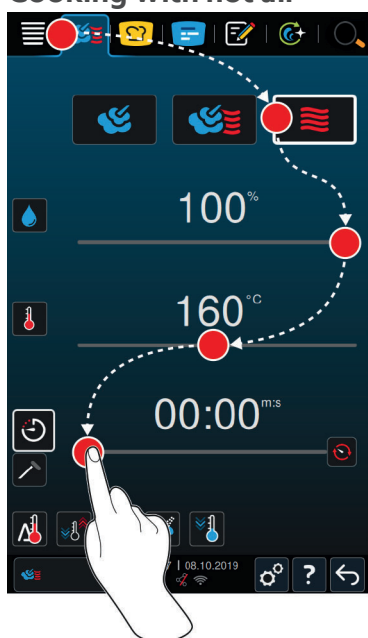
If the cooking cabinet temperature remains above 500°F for 30 minutes, it will automatically be reduced to 500°F if you do not work with the unit during that time. Taking action within those 30 minutes (opening the cooking cabinet door, for example) will reset the timer - the cooking cabinet temperature will be kept above 500°F for another 30 minutes.

5.4.2 Cooking with hot air



1. In the menu bar, press this button: 
2. Press this button: 
 - > The cooking system will preheat to the set temperature.
3. Press this button:  to set the maximum permitted humidity in the cooking cabinet.
4. Set the cooking cabinet temperature you want.
5. To cook based on cooking time, press this button: 
6. Set the cooking time.
 - > The cooking time will begin immediately when you press the dial or after five seconds with no additional input.
7. To cook using the core temperature probe, press this button: 
8. Set the core temperature.
 - > Once the set cooking cabinet temperature has been reached, you will be prompted to load the food.
9. Load product now.

>> The cooking path will continue. Once the cooking time has elapsed or the food has reached the set core temperature, a signal tone will sound, prompting you to check whether the food has reached your desired level of doneness.

5.5 Cancel manual cooking

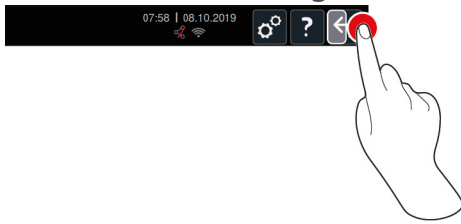

1. Press and hold this button: ↶
 - > The cooking process is canceled. The home screen will appear.

6 Sous-vide cooking

In sous-vide cooking, food is prepared, seasoned, marinated and/or seared before being placed into a vacuum bag and cooked at a low temperature. The method results in very flavorful food which retains its natural color, vitamins and minerals, and the gentle cooking process minimizes cooking losses. After cooking, the food needs to be cooled down. Before serving, the food is reheated in its plastic bag, then removed from the bag and finished accordingly.

Sous-vide cooking is particularly suitable for the following uses:

- **Cook and Chill**
Produce your food in a central production kitchen and then deliver it to satellite kitchens. This allows you to avoid costly overproduction, because you only Finish food you actually need.
- **Room service**
Produce dishes or individual components in advance, chill them and then Finish individual portions to order. This method allows you to offer 24-hour service whether or not an experienced cook is in the kitchen.
- **Special diets**
This gentle cooking method preserves food's natural flavor, making it ideal for preparing low-fat, low-salt, or other special dietary options.

For detailed information on sous-vide cooking paths, see [Sous-vide cooking paths](#) [▶ 31].



TIP

The sous-vide core temperature probe is an accessory available to help you make sure that your food reaches the correct core temperature when using sous-vide cooking applications. Expanded, automatic HACCP documentation of core temperatures ensures that basic principles of food hygiene are documented appropriately.

Additional details on assembling and using the sous-vide core temperature probe are available in the USB core temperature probe instructions for use, which you can download from our website.

6.1 Sous-vide cooking paths

These cooking paths are only accessible when using the sous-vide USB core temperature probe.

Sous-vide poultry

Select this cooking path if you want to cook pieces of poultry in vacuum pouches using the sous-vide method.

Sous-vide meat

Select this cooking path if you would like to prepare salt-crusted fish.

Sous-vide fish

Select this cooking path if you would like to prepare salt-crusted fish.

Sous-vide side dishes

Select this cooking path if you would like to prepare salt-crusted fish.

7 Pasteurizing

Pasteurization heats food to reduce germs and microorganisms, which extends shelf life. Food is prepared, transferred into suitable containers and heated gently at controlled temperatures. This preserves the food's flavor while ensuring its safety and quality.

7.1 Pasteurization cooking paths

These cooking paths are only accessible when using the sous-vide USB core temperature probe.

Pasteurizing

Select this cooking path if you want to pasteurize.

Pasteurizing poultry

Select this cooking path if you would like to prepare onsen eggs.

Pasteurizing_meat

Select this cooking path if you want to pasteurize meat.

Pasteurizing eggs

Select this cooking path if you would like to prepare onsen eggs.

Convenience pasteurization

Select this cooking path if you want to pasteurize previously cooked products in vacuum packaging for improved shelf life. This cooking path is particularly well-suited to producing your own convenience food.

Container pasteurization

Select this cooking path if you would like to prepare onsen eggs.

8 Smoking

Smoking involves exposing food to aromatic smoke, which gives it a unique and intense flavor. The food is prepared, seasoned or marinated and then loaded into the cooking system set to smoking mode.

8.1 Smoking cooking paths

These cooking paths are only available to users of the new VarioSmoker with USB connection.

Hot smoking Poultry

Select this cooking path to smoke poultry. You can specify a target core temperature as well as a cooking time.

Hot smoking Turkey

Select this cooking path to smoke turkey. You can specify a target core temperature as well as a cooking time.

Hot smoking Fish

Select this cooking path to smoke fish. You can also cook the fish while smoking it. You can specify a target core temperature as well as a cooking time.

Hot smoking Side Dishes

Select this cooking path to smoke side dishes, or to create interesting vegetarian/vegan dishes and components. You can also cook the fish while smoking it. You can set a desired temperature and/or a target cooking time.

Low temperature smoking

Select this cooking path to smoke pieces of meat gently while cooking them at the same time. You can specify a target core temperature as well as a cooking time.

Braise and smoke

Select this cooking path to smoke pieces of meat gently and braise them at the same time. You can specify a target core temperature as well as a cooking time.

9 Low temperature cooking

Cooking large meat and poultry products requires a lot of time-intensive monitoring and many years of experience, plus it renders conventional appliances unavailable for hours on end. With your cooking system, you can face these challenges with less worry: you can roast, boil, or braise food slowly at low temperatures during off-peak hours, such as during the afternoon or outside of service periods, so you can make optimum use of your cooking system, up to 24 hours a day. Cooking overnight also lets you take advantage of lower nighttime electricity prices.



TIP

If the power goes out while low temperature cooking is in process, the cooking path will be interrupted. If the power outage lasts less than 15 minutes, the cooking path will be resumed. If it lasts for more than 15 minutes, the cooking system will switch to standby mode after the power returns. You will need to either restart the cooking path from the point when the power failure occurred or finish cooking the food manually.

10 Finishing

Finishing allows you to separate food production and service, giving you more flexibility to spend time on important things like planning, menu design, or creative plating. Finishing minimizes loss of quality caused by long holding periods, so your food always comes out tasting great.



- You can Finish exactly as much food as you currently need, so you can respond easily to changing guest numbers.
- Shortened production and service times mean there's no more hectic rush to get everything plated.
- Reduce personnel costs by utilizing time efficiently and streamlining the process of getting food out to customers.
- Run multiple events at the same time, maximizing capacity usage without increasing expenses.

Whether you're cooking in a restaurant, a hotel, or a lunchroom, Finishing makes it even easier to serve a wide variety of great-tasting food:

- **Finishing in restaurants**
Use Finishing to get food ready exactly when you need it.
- **Finishing in hotels**
Plate Finishing is perfect when you need to be able to serve a large number of plates at the same time, e.g., conferences, weddings, or catering.
- **Finishing in food service operations**
Container Finishing is especially useful when you need to provide a wide variety of food in large quantities.

10.1 Set à la carte plate weight

Before starting the Finishing step, set how heavy an empty plate is. Based on this information, the cooking system will adjust the cooking steps to ensure ideal Finishing results and prevent moisture from condensing onto the plates.



1. Press this button: 
2. Press this button:  **Cooking**
3. Press this button:  **A la carte plate weight**
4. Select one of the following values:
 - <750 g
 - 750 g – 899 g
 - 900 g – 1099 g
 - >1100 g

10.2 Setting the banqueting plate weight

NOTE

To prevent material damage, insert the core temperature probe into the ceramic tube on the right side of the mobile plate rack after loading.

Before starting the Finishing step, set how heavy an empty plate is. Based on this information, the cooking system will adjust the cooking steps to ensure ideal Finishing results and prevent moisture from condensing onto the plates.

1. Press this button: 
2. Press this button:  **Cooking**
3. Press this button:  **Banquet plate weight**
4. Select one of the following values:
 - <750 g

- 750 g – 899 g
- 900 g – 1099 g
- >1100 g

11 iProductionManager



iProductionManager organizes the entire production process intelligently and flexibly. It identifies which foods can be prepared together, determines the perfect order to prepare the foods, and monitors each cooking path separately.



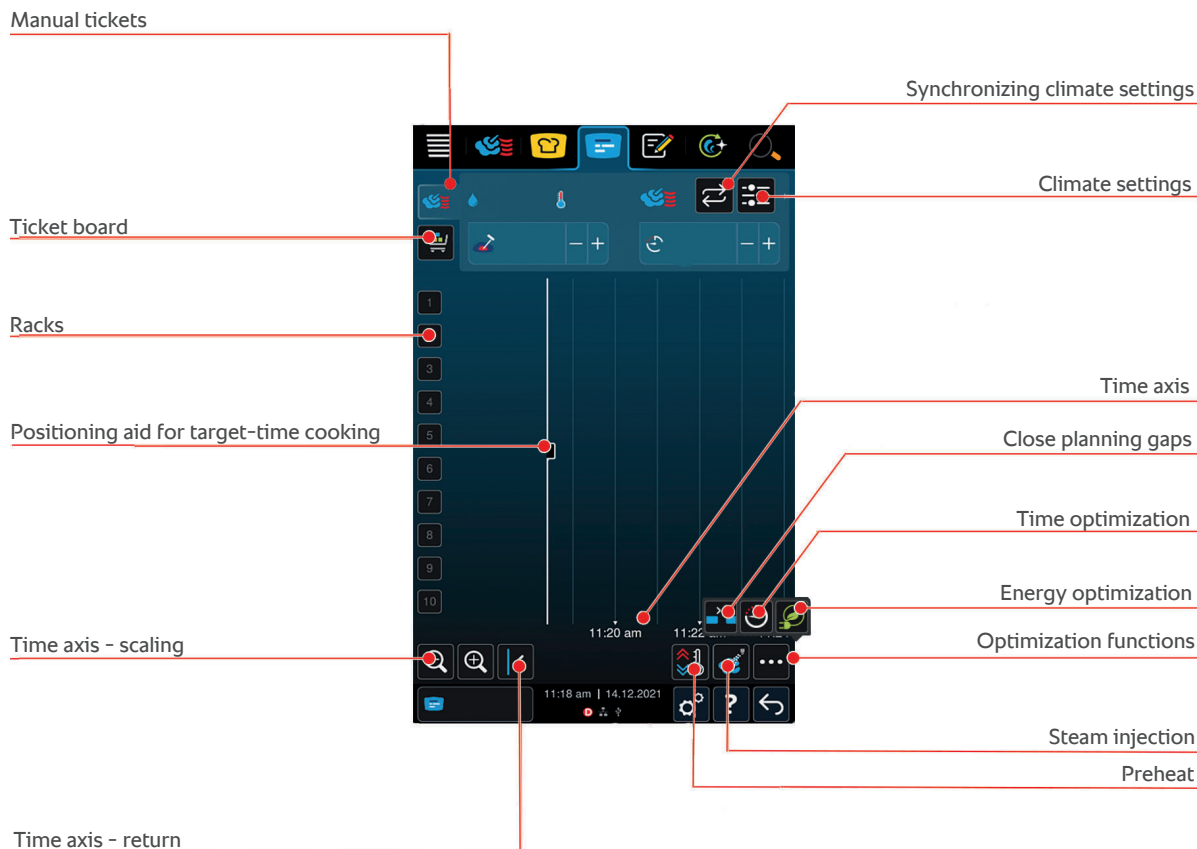







iProductionManager lets you know when each dish needs to be put in or taken out. You decide whether to optimize cooking speed, maximize your energy efficiency, or have your food ready at a target time, and iProductionManager intelligently arranges the order of preparation accordingly. You'll have everything under control without needing to monitor a thing, making your food production process more efficient than ever.



11.1 Creating manual tickets

You can add manual tickets to the iProductionManager. First select the climate and then select whether the ticket should be created based on cooking time or core temperature. Please note: If you are cooking food with the integrated core probe, you can only place one manual core temperature ticket on the time axis at the same time.





1. In the menu bar, press this button: 
 2. Press this button: 
 3. Press this button: 
 4. Select the operating mode: Steam [▶ 27]  Combi-Steam [▶ 28]  or Convection [▶ 29] 
 5. Adjust the cooking parameters as desired. You can also set the speed of the fan wheel. To do so, press this button: 
 6. To save your changes, press this button: 
 7. To increase or decrease the core temperature or the cooking time, either turn the central dial or press the buttons:  or 
 8. Press the button until the desired setting is achieved.
- >> You can now place the tickets [▶ 40].



11.2 Ticket board

You can add any intelligent cooking paths, programs, or shopping carts to the ticket board. If you do not save the ticket board using Save shopping cart [▶ 51], it will be overwritten as soon as a new shopping cart is loaded.

11.2.1 Adding intelligent cooking paths

1. To send an intelligent cooking path from the iCookingSuite to the iProductionManager, press this button in the menu bar: 
 2. Press this button beside your chosen cooking path: 
 3. Press this button: 
- >> The intelligent cooking path will be sent to the iProductionManager and displayed on the ticket board.









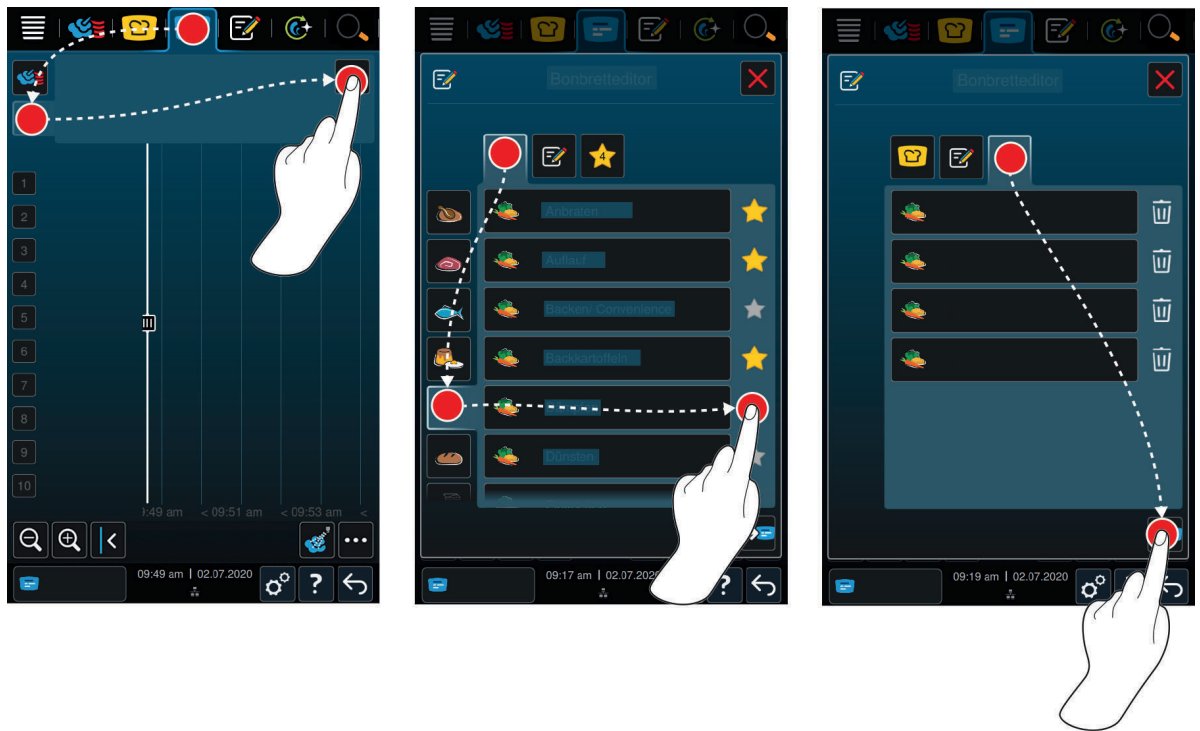

11.2.2 Adding programs and shopping carts

1. In the menu bar, press this button: 
 2. To send a manual or intelligent program to the iProductionManager, press this button beside the program: 
 3. Press this button: 
- > The program will be sent to the iProductionManager and displayed on the ticket board.

4. To send a shopping cart to the iProductionManager, tap the shopping cart you want to use.
 - > The shopping cart will be sent to the iProductionManager. All programs will be displayed on the ticket board.

11.2.3 Ticket board editor



1. In the menu bar, press this button: 
 2. Press this button: 
 3. Press this button: 
 4. To add intelligent cooking paths to the shopping cart, press this button: 
 - > All intelligent cooking paths will be displayed.
 5. Scroll through the list or select a cooking mode and then tap the cooking path you want to add.
 - > The cooking path is  and add it to the ticket board.
 6. To add programs to the shopping cart from programming mode, press this button: 
 - > All saved programs will be displayed. If you have not yet saved any programs, this section will be empty.
 7. Scroll through the list or select manual or intelligent programs, and then tap the program you want to add.
 - > The system will mark the program with  and add it to the ticket board.
 8. To check the contents of the ticket board, press this button: 
 9. To delete an intelligent cooking path or a program, press this button: 
 10. To update the ticket board, press this button: 
- >> The intelligent cooking paths or programs will be shown on the ticket board. You can now place the tickets [▶ 40].

11.3 Timer

Even if the combination check [▶ 41] prevents you from placing tickets a certain way, you can still place a timer. The timer is a time ticket, set to 5 minutes by default. The timer does not have its own assigned climate, i.e., placing a timer will not result in a climate being established or affect the current climate. You can adjust the length of the timer as needed and place it at the current time or in the future.

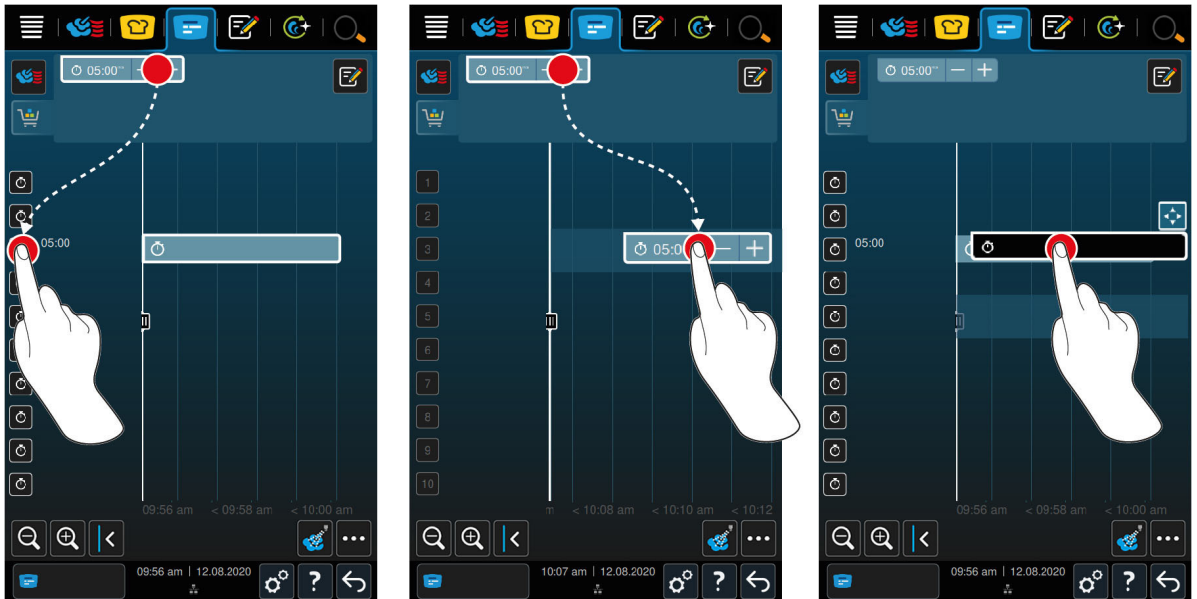

1. To place a timer at the current time, first tap the timer on the ticket board, and then select a rack level.
 - > The timer will be placed at the current time.
 2. To place a timer in the future, drag the timer to the start time and rack level of your choice.
 3. To move the timer to a different rack level or change its start time, press and hold the timer.
 4. Drag the timer to the correct position.
 5. To increase or decrease timer length, tap the timer briefly,
 6. and then either rotate the selection dial or press these buttons: **+** Or **-**
 - > After a brief waiting period, your new settings will be applied.
- >> When the timer goes off, you will be prompted to unload the cooking system. This symbol will appear beside the rack level: . The cooking time is at 00:00.

11.4 Placing tickets

- ✓ You have created manual tickets [▶ 37], shopping carts [▶ 38] or a ticket board [▶ 39].
1. Drag a ticket to the desired rack level.
 - > For better orientation, the rack level you are placing the ticket on will be highlighted in blue. The time will also be displayed on the ticket as an additional aid.
 - > If the rack level is marked in yellow or red, it means that you cannot place the ticket without moving tickets that have already been placed. More information is available here: Combination check [▶ 41] and placement logic [▶ 41]

2. If you have placed multiple tickets, scale the time axis back to a summary view. To do so, press this button: 

The following options are available to optimize the positioning of the tickets:

- Close planning gaps [▶ 41]
- Time optimization [▶ 42]
- Energy optimization [▶ 43]
- Target time cooking [▶ 44]

If you place tickets for the actual time, a vertical yellow or blue bar will appear:

- A yellow bar indicates that the cooking cabinet is heating up.
- A blue bar indicates that the cooking cabinet is being cooled down with the Cool Down function.
- The width of the bar indicates how long the heating or cooling will take.

Once the desired temperature is reached, you will be prompted to load the food. This symbol will appear beside the rack level: .

Once you have loaded the cooking system, it will display the remaining time for the food to remain in the cooking cabinet next to the corresponding rack level.

When the cooking process on the ticket finishes, you will be prompted to unload the cooking system. This symbol will appear beside the rack level: . The cooking time is at 00:00.

11.4.1 Combination check

For each ticket you want to place in the iProductionManager, a check is carried out to determine whether the new ticket matches the already positioned tickets and can be placed at the selected time. The tickets are separated based on the following 3 values and checked independently of each other:

- Each ticket is assigned an operating mode. A check will be carried out to determine whether the operating modes match.
- A cooking cabinet temperature is assigned to each ticket. A check will be carried out to determine whether the cooking cabinet temperatures match.
- A cooking cabinet humidity is assigned to each operating mode. A check is carried out to determine whether the cooking cabinet humidities match.

Both manual operating modes and intelligent cooking paths are checked for compatibility. You can only combine cooking paths that are cooked in a consistent climate. Cooking paths that run through different climates, such as low-temperature roasting, can not be combined with other tickets. Furthermore, only single-step manual programs can be combined.

11.4.2 Positioning logic

Based on the combination check, the iCombi Pro decides where the ticket is placed. The tickets are positioned optimally in the iProductionManager depending on the result of the check. A color marking in the rack levels indicates whether a new ticket will impact the already positioned tickets in the iProductionManager:

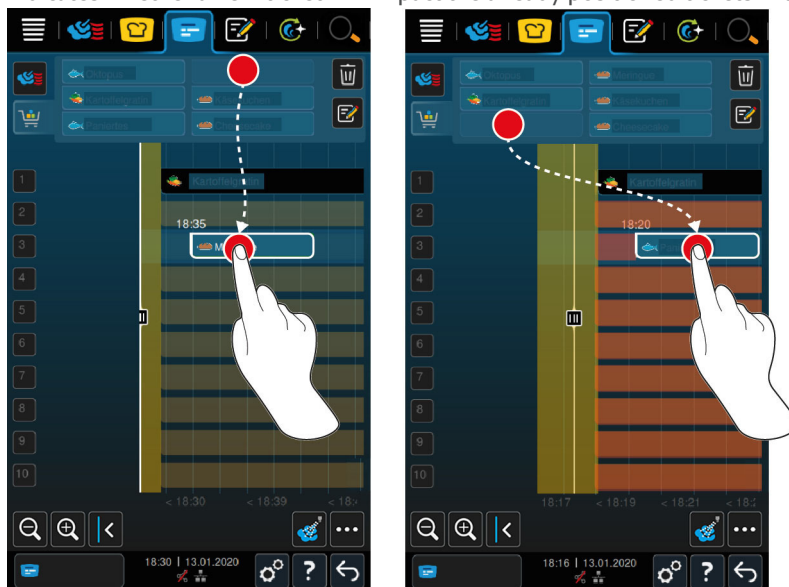

- If the rack levels are marked in yellow, you can place a ticket, but tickets that are already placed are moved.
- If the background is red, you can not place the ticket because a ticket is already being processed.

If you move a ticket, the entire block in which the ticket was placed after the combination check is moved.

11.4.3 Close planning gaps

You can have time gaps that were created when placing tickets across all rack levels closed automatically by your unit.

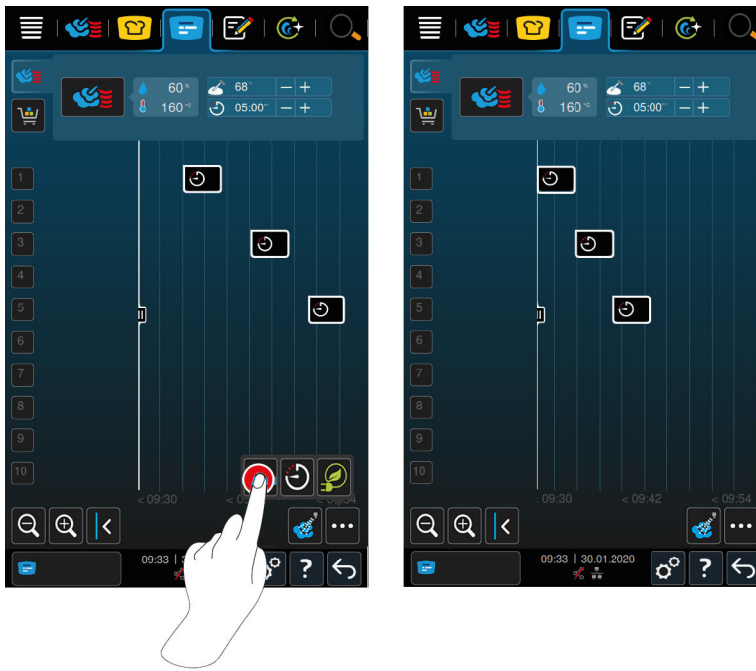

✓ You have created and positioned tickets.

1. Press this button: 

> You are asked whether you really want to close the planning gaps. **NOTE! The action can not be reversed.**

2. Confirm the question with: **OK**

>> The time gaps between the tickets are closed. The positioning of the tickets in relation to each other is retained. The positioning of the tickets on the time axis can move.

11.4.4 Time optimization

You can have tickets that you have already placed in the iProductionManager optimized automatically by your iCombi Pro so that the dishes are cooked in an optimal sequence and time gaps are closed. The time sequence and positioning on the rack levels is retained.

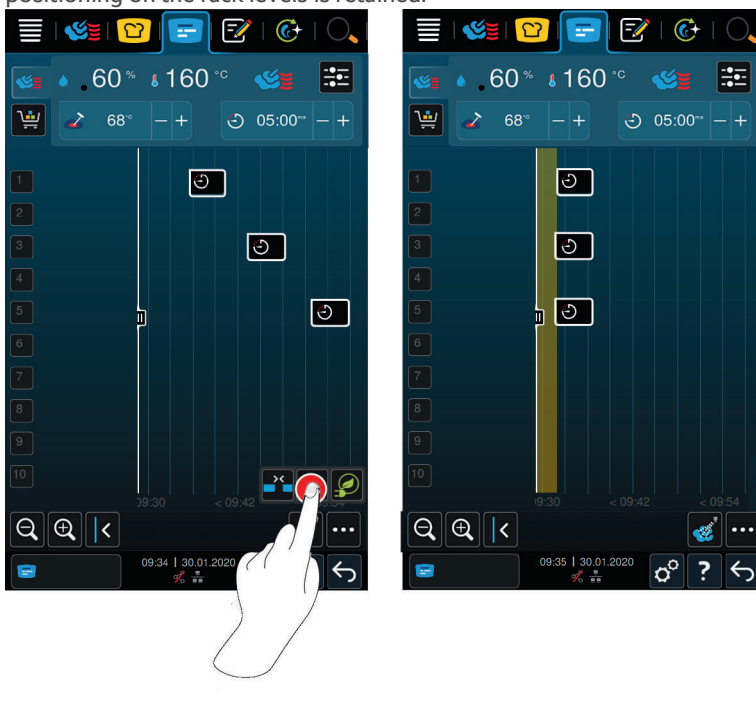

✓ You have created and positioned tickets.

1. Press this button: 

> You are asked whether you would really like to close the time gaps. **NOTE! The action can not be reversed.**

2. Confirm the question with: **OK**

>> The tickets are re-positioned depending on the combination check [▶ 41].

11.4.5 Energy optimization

You can have tickets that you have already placed in the iProductionManager optimized automatically by your iCombi Pro so that the dishes are cooked in the most energy-efficient way. This enables the unit utilization to be optimized and energy to be saved. Please note that the time sequence of the tickets can change during this process.

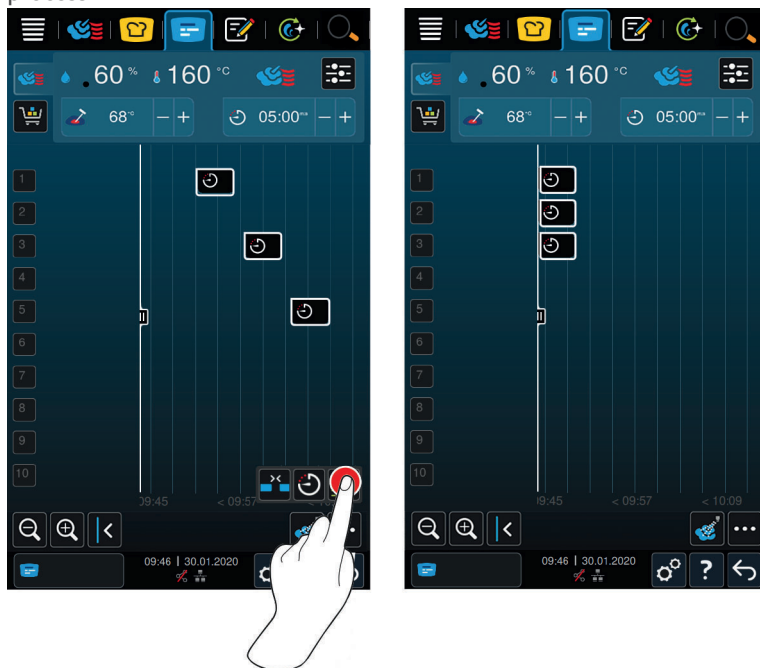

✓ You have created and positioned tickets.

1. Press this button: 

> You are asked whether you would really like the tickets to be arranged in an energy-optimized way. **NOTE! The action can not be reversed.**

2. Confirm the question with: **OK**

>> The tickets are re-positioned depending on the combination check [▶ 41].

11.5 Editing and deleting tickets



Manual tickets

Once you have placed a manual ticket, you can either adjust the core temperature or extend the cooking time. You cannot adjust the climate settings.

1. Tap the ticket.
 - > The settings for that ticket will be displayed.
2. To increase or decrease the core temperature or the cooking time, press these buttons: + or —
3. To delete the ticket, press this button: 

Intelligent tickets and programs

With many intelligent tickets or programs, you can change the settings after they have been placed. For some, you can only delete the ticket.

1. To increase or decrease the core temperature or the cooking time, press these buttons: + or —
2. To delete the ticket, press this button: 

11.6 Target time cooking

In the iProductionManager, you can plan the dishes so that the dishes start cooking at the same time or dishes are finished at the same time. You can carry out this planning either at the current time or in the future. To do this, position the tickets before or after the positioning aid. When you start the iProductionManager, the positioning aid marks the actual time. If you slide the positioning aid to the right, the time axis will be shifted to the future.

1. In the menu bar, press this button: 
2. Activate the positioning aid by pressing it and then drag it to the desired point on the time axis. If you move the positioning aid to the right edge of the display, the time axis will be moved into the future.
3. Position the desired tickets on the right or left of the positioning aid.
 - > If you place a ticket to the left of the positioning aid, the end of the ticket will be set for this time. Your dishes will finish cooking at the same time.
 - > If you place a ticket to the right of the positioning aid, the start of the ticket will be set for this time. Double-tapping the slider icon on the positioning aid will make the dishes begin cooking simultaneously.

11.7 Planning



With the iProductionManager's planning function, you need only place tickets once, and then you can access them at any time.



- It is not possible to save previously completed tickets as a plan.
- The **Moisten** function is not available in planning.

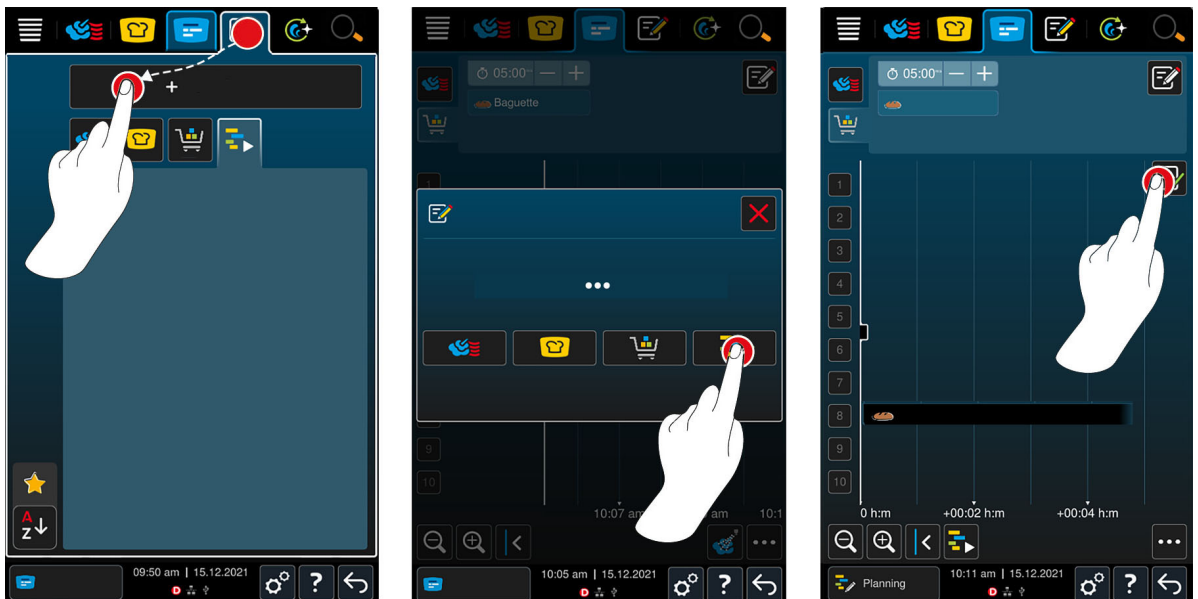

11.7.1 Creating plans



1. In the menu bar, press this button: 
2. In the menu bar, press this button: 
3. Press this button: **+New planning**
4. Press this button: 
 - > The positioning aid will slide to the left edge of the display. The time axis will switch from showing the current time of day to displaying time in minutes. You can now place tickets independently of the time of day.
5. Place the tickets you want to use. You can incorporate up to 30 tickets.

The following planning-optimization functions are available:

- Close planning gaps [▶ 41]
- Time optimization [▶ 42]
- Energy optimization [▶ 43]

1. To start the plan without saving it, press this button: 
2. To save the plan, press this button: 

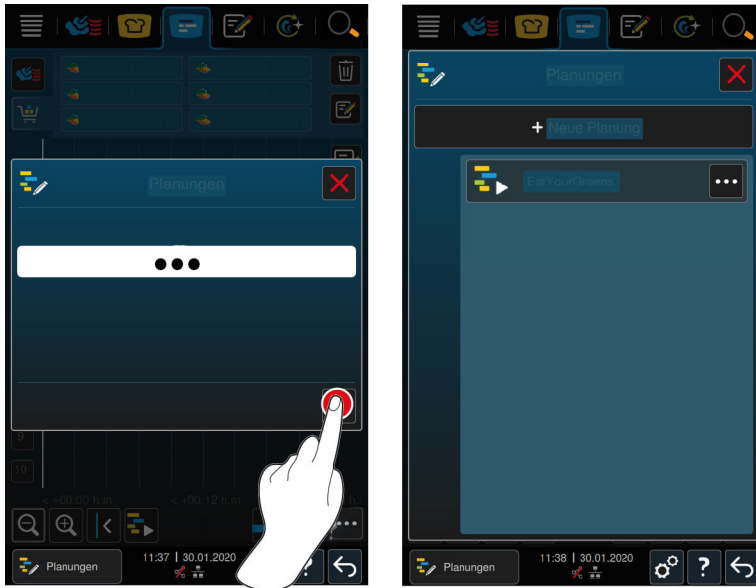

3. Enter a name.
 4. To confirm, press this button: ✓
- >> The plan will be added to your list of plans.

11.7.2 Starting plans

- ✓ Use this feature after creating plans. [▶ 45]
 - ✓ Make sure that the iProductionManager is not currently running a ticket. If tickets are in progress, a message will be displayed to notify you that all tickets will need to be canceled before the plan can be run.
1. Press this button:  in the cooking system menu under *Programming*.
 2. Press the plan you want to run.
- >> The plan will start immediately. Tickets will be placed on levels in accordance with the plan. The tickets on the ticket board will be replaced with the ones in the plan.

12 Programming mode



You can create, save, and manage your own manual programs [▶ 47], intelligent cooking paths [▶ 49] and shopping carts [▶ 51] in programming mode. You can choose from among any of the available manual operating modes [▶ 25], intelligent cooking paths, cleaning programs [▶ 54] and pre-programmed shopping carts.

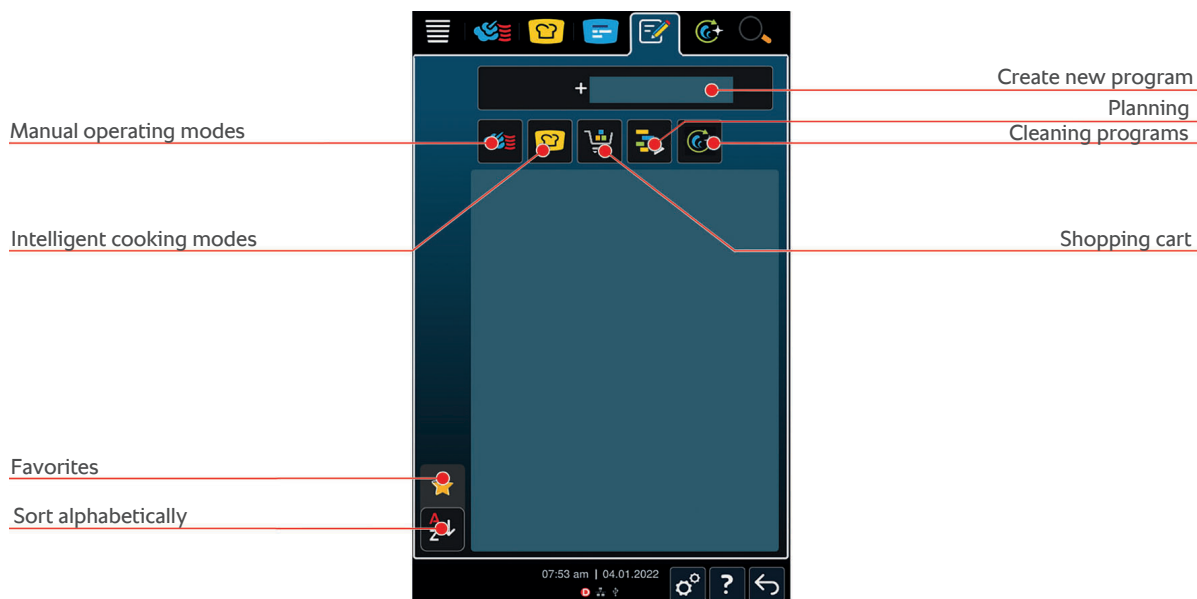

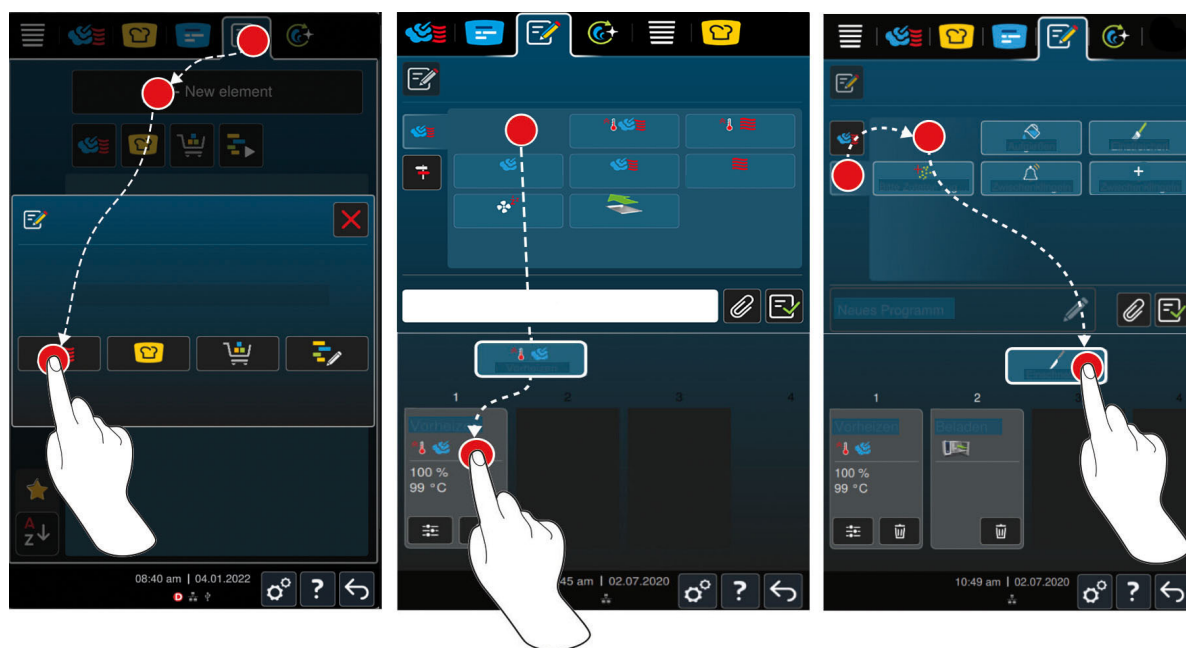

12.1 Creating programs manually

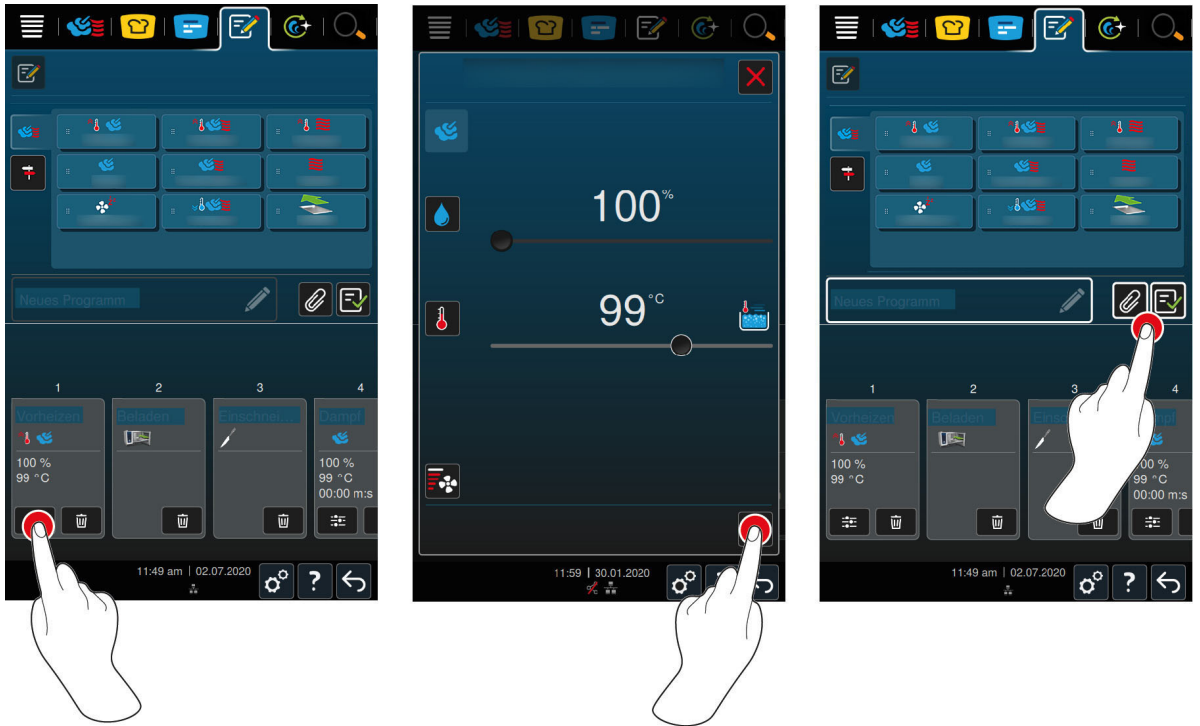

1. In the menu bar, press this button:
2. Press this button: + **New element**
3. Press this button:
 - > A summary view of available cooking steps will be displayed.
4. Select the cooking steps you want to use and drag them to the bottom section. **NOTE! You cannot combine certain cooking steps.**
5. To add prompts to the program, press this button:

- > A summary view of available prompts will be displayed. These configurable action cards help you plan intermediate steps during the cooking process. You can either use the preset action cards or create your own.
- 6. Select the prompts you want to use and drag them to the bottom section.
- 7. You also have the option of creating your own action cards. To do so, press this button: . Now you can name your action card and add text, an image, and a sound.



- 8. To edit a cooking step, press this button: 
 - > The cooking parameters and additional functions available for that operating mode will be displayed.







cooking step	Cooking parameter	Additional functions
Preheat	<ul style="list-style-type: none"> ▪ Cooking cabinet temperature 	<ul style="list-style-type: none"> ▪ Fan speed
Steam	<ul style="list-style-type: none"> ▪ Cooking cabinet temperature ▪ Cooking time ▪ Core temperature 	<ul style="list-style-type: none"> ▪ Delta-T cooking ▪ Fan speed
Combi-steam	<ul style="list-style-type: none"> ▪ Cooking cabinet humidity ▪ Cooking cabinet temperature ▪ Cooking time ▪ Core temperature 	<ul style="list-style-type: none"> ▪ Delta-T cooking ▪ Fan speed ▪ Steam injection
Hot Air	<ul style="list-style-type: none"> ▪ Cooking cabinet humidity ▪ Cooking cabinet temperature ▪ Cooking time ▪ Core temperature 	<ul style="list-style-type: none"> ▪ Delta-T cooking ▪ Fan speed ▪ Steam injection
Cool down	<ul style="list-style-type: none"> ▪ Cooking cabinet temperature 	<ul style="list-style-type: none"> ▪ Fan speed

1. Adjust the cooking step as desired.
2. To save your changes, press this button: 



Default start times and program images

✓ Use this function once you have imported images [▶ 67].

1. To assign a default start time to a program, press this button: 

2. Press this button:  **Default start time**
3. Press this button: **ON**
4. Enter the start time.
5. To confirm, press this button: 
6. To assign an image to the program, press this button: 
7. Press this button:  **Select program image**
8. Select an image.
9. To confirm, press this button: 
10. To set a low fan level after loading, press this button: .



Saving a program

1. To give the profile a name, press this button: 
 2. Enter a name.
 3. To save your program, press this button: 
- >> The system will check the program. If all cooking parameters are fully defined and logically organized, the program will be saved and added to the list of available programs.
- >> If the program contains an error, that section of the program will be marked. Fix the error before saving the program again.

12.2 Creating an intelligent program

On intelligent cooking paths, you can only adjust the cooking parameters - it is not possible to re-sequence the individual cooking steps.





1. In the menu bar, press this button: 
2. Press this button: **+ New element**
3. Press this button: 
 - > The system will ask you what you would like to program.
4. Select one of the following options:
 - operating mode
 - Operating mode and cooking method
 - Cooking method



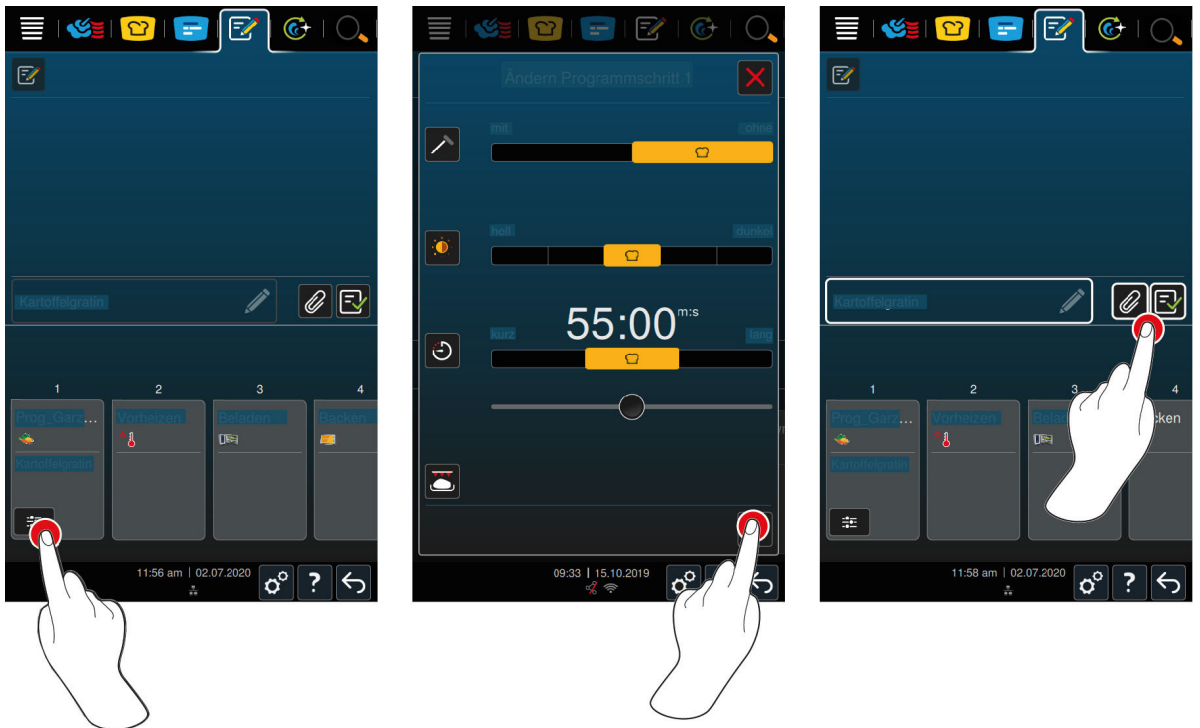



After making your selection, any matching intelligent cooking paths will be shown on the display.

1. Select an intelligent cooking path.
 - > The individual cooking steps will be displayed. Now you are ready to adjust the cooking parameters to fit your needs.





2. Press this button: 
 - > Any editable cooking parameters and additional functions for that cooking path will be displayed. Standard settings for the cooking path are marked with this symbol: 
3. Adjust the cooking parameters as desired.
4. To save your changes, press this button: 
 - > The individual cooking steps will be displayed again.

Default start times and program images

- ✓ Use this function once you have imported images [▶ 67].
1. To assign a default start time to a program, press this button: 
 2. Press this button:  **Default start time**
 3. Press this button: **ON**
 4. Enter the start time.
 5. To confirm, press this button: 
 6. To assign an image to the program, press this button: 
 7. Press this button:  **Select program image**
 8. Select an image.
 9. To confirm, press this button: 
 10. To set a low fan level after loading, press this button: 





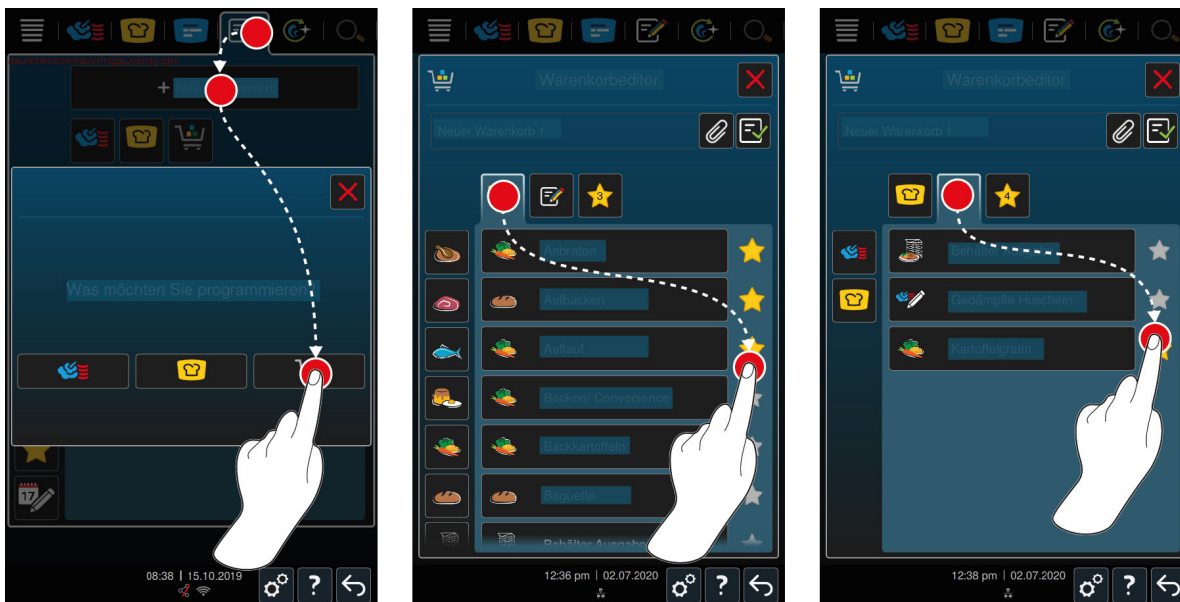

Saving a program

1. To give the profile a name, press this button: 
2. Enter a name.
3. To save your program, press this button: 

>> The program will be shown in the list of programs.



12.3 Programming shopping carts



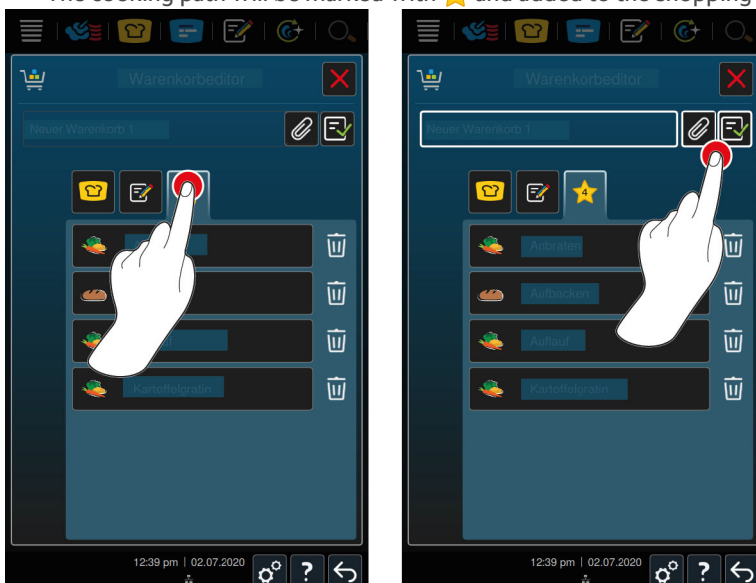

1. In the menu bar, press this button: 
2. Press this button: **+ New element**
3. Press this button: 
4. To add intelligent cooking paths to the shopping cart, press this button: 
 - > All intelligent cooking paths will be displayed.
5. Scroll through the list or select a cooking mode and then tap the cooking path you want to add.
 - > The cooking path will be marked with  and added to the shopping cart. You can also check whether cooking paths can be combined by holding the buttons for the selected cooking paths. A green check mark indicates that applications can be combined.
6. To add previously saved programs to the shopping cart, press this button: 
7. Scroll through the list or select manual or intelligent programs, and then tap the program you want to add.
 - > The cooking path will be marked with  and added to the shopping cart.



Reviewing shopping carts

1. To review the shopping cart, press this button: 
 - > All selected intelligent cooking paths and programs will be displayed.
2. To delete an element from the shopping cart, press this button: 

Saving a shopping cart

1. To give the shopping cart a name, press this button: 
 2. Enter a name.
 3. To save the shopping cart, press this button: 
- >> The shopping cart will be shown in the list of programs.

Checking combinability

You can check whether applications can be combined in programming mode.







1. Press and hold the selected application.
2. Applications that are marked with a green check can be combined with the selected application.
3. Applications marked with a red X cannot be combined with the selected application.

12.4 Editing and deleting programs

- ✓ Use this feature once you have created manual programs [▶ 47], intelligent cooking paths [▶ 49] or shopping carts [▶ 51].



1. To edit a program, press this button: 

The following editing options are available:



- Edit element 
- Duplicate element 
- Delete element 
- Set default start time 
- Send program to iProduction Manager 
- Add program to favorites 

12.5 Starting programs and shopping carts

Starting manual programs

1. To start a manual program, tap the program you want to use.
 - > The program will start immediately. All cooking steps will be displayed.
 2. To send a manual program to iProductionManager, press this button: 
 3. Press this button: 
- >> The manual program will be displayed on the ticket board. You can now place the ticket as usual [▶ 40].

Starting an intelligent cooking path

1. To start an intelligent cooking path, tap the program you want to use.
 - > The program will start immediately. All cooking steps will be displayed.
 2. To send an intelligent cooking path to iProductionManager, press this button: 
 3. Press this button: 
- >> The intelligent program will be displayed on the ticket board. You can now place the ticket as usual [▶ 40].

Starting shopping carts

1. To add a shopping cart to iProductionManager, tap the shopping cart you want to use.
 - > All elements within the shopping cart will be shown on the ticket board. You can now place the tickets as usual [▶ 40].

13 Programming mode – iCareSystem AutoDose



You can create, save, and manage your own manual programs [▶ 47], intelligent cooking paths [▶ 49] and shopping carts [▶ 51] in programming mode. You can choose from among any of the available manual operating modes [▶ 25], intelligent cooking paths, cleaning programs [▶ 54] and pre-programmed shopping carts.

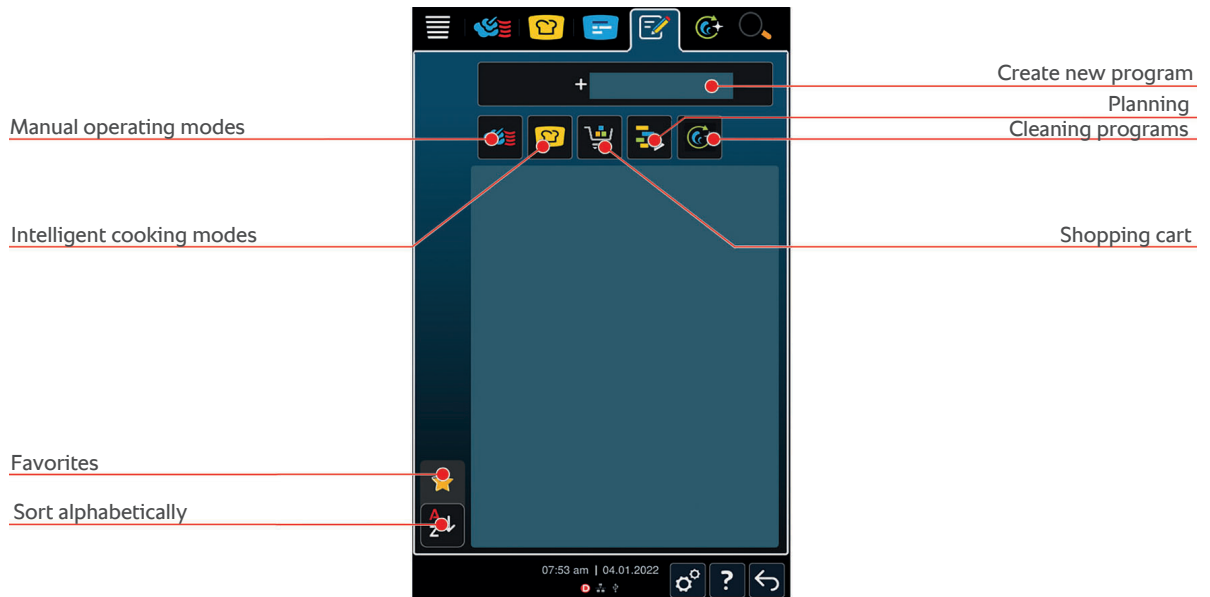

13.1 Create cleaning program (chemical reserves)

You can create your own cleaning program here:

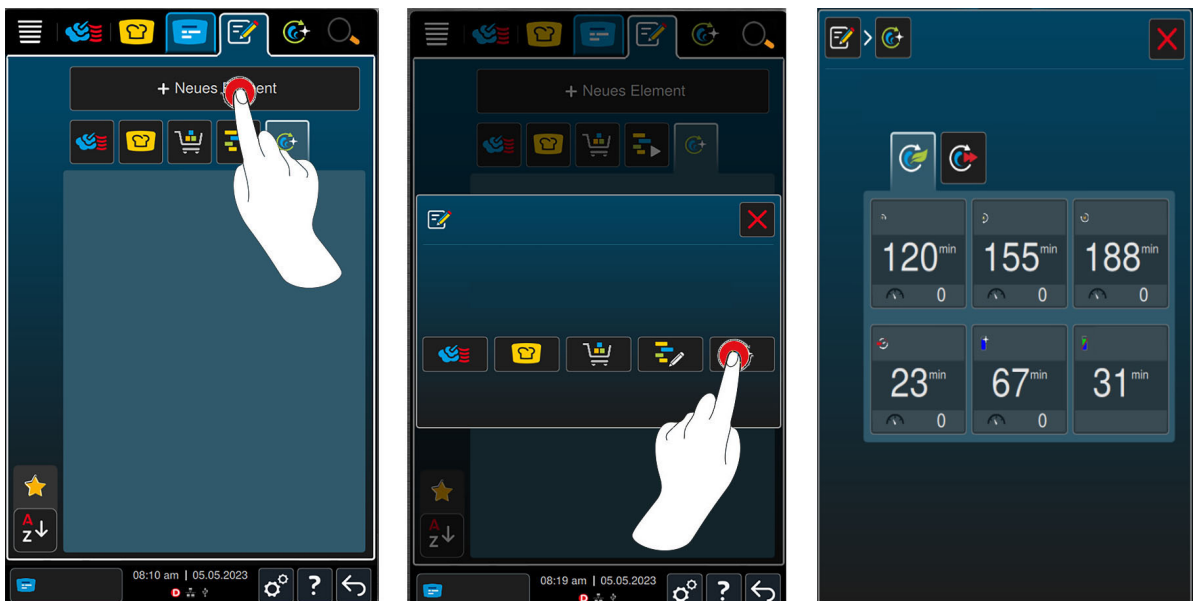

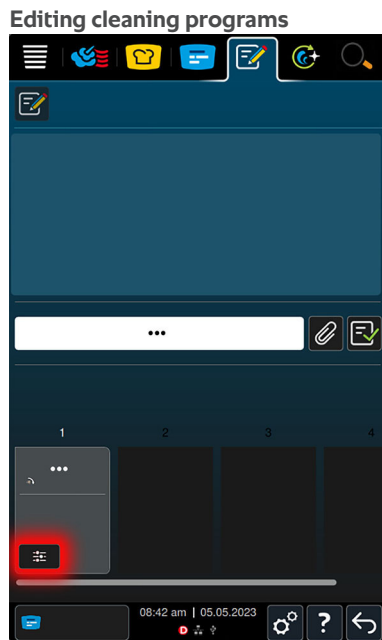

1. Press this button: Programming mode.
2. Press this button: **+ New element.**
3. Press this button: .
4. Press this button: Eco mode or Normal mode to customize cleaning programs as desired.

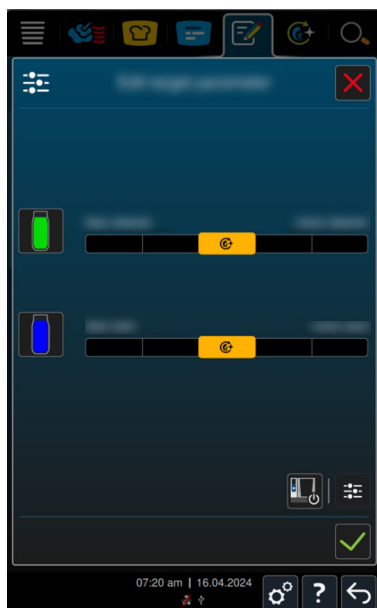

After selecting a cleaning program, press  to edit the target parameters.



You can increase or decrease the quantities of cleaning and care products used during cleaning.



- Press this button:  to confirm your selection.
- Press this button:  to save your cleaning program settings.
- Press this button:  to switch off the cooking system after cleaning.





13.2 Editing and deleting programs (chemical reserves)

✓ You have programmed manual programs [▶ 47], intelligent cooking paths, [▶ 49] shopping carts [▶ 51] or cleaning programs. [▶ 54]

1. To edit a program, press this button: 

The following editing options are available:

- Edit element 
- Duplicate element 

- Delete element 
- Set default start time 
- Send program to iProduction Manager 
- Add program to favorites 



14 Switching between operating modes

With iCombi Pro, you can switch easily between the manual cooking, iCookingSuite and iProductionManager cooking modes at any time. This offers the optimal mix of automatic, work-saving cooking intelligence and individually desired control options. You can run the following main applications:

- Change a ticket to a manual operating made in the iProductionManager.
- Change an intelligent cooking path from the iCookingSuite to an intelligent ticket in the iProductionManager.
- Change an intelligent cooking path from the iCookingSuite to a manual operating mode.



Changing a ticket to a manual operating mode

✓ Use this function after placing a ticket [▶ 40]. Use this function while cooking is in process.

1. In the menu bar, press this button: 
 - > A query field will appear so that you can confirm the changeover to the manual operating mode.
 2. **NOTE! This action cannot be undone.** Press this button: 
- >> The cooking parameters of the ticket are adopted and displayed in the manual mode.



Changing an intelligent cooking path into an intelligent ticket

✓ Use this function after starting an intelligent cooking path. Use this function while cooking is in process.

1. In the menu bar, press this button: 
 - > A query field will appear so that you can confirm the changeover to iProductionManager.
 2. **NOTE! This action cannot be undone.** Press this button: 
- >> The intelligent cooking path will be sent to iProductionManager and displayed on the center rack level.

Changing an intelligent cooking path into a manual mode

✓ Use this function after starting an intelligent cooking path. Use this function while cooking is in process.

1. In the menu bar, press this button: 
 - > A query field will appear so that you can confirm the changeover to the manual operating mode.
 2. **NOTE! This action cannot be undone.** Press this button: 
- >> The current cooking parameter settings will be applied from the intelligent cooking path, displayed in manual mode and started directly.

15 Settings



You can permanently change the factory settings on your unit to suit your requirements.

1. Press this button: 

> You will see a list of all available settings options:

- Favorites [▶ 58]
- Display [▶ 58]
- Light [▶ 60]
- Sound [▶ 60]
- Cooking system [▶ 62]
- Cooking [▶ 64]
- cleaning
- Data management [▶ 66]
- Network settings [▶ 69]
- User profile [▶ 71]
- Service [▶ 75]
- ConnectedCooking [▶ 75]

Change settings by scrolling through the list and pressing on the desired category. Each category has a selection of settings options assigned to it; these can be modified using gestures [▶ 16] or the selection dial [▶ 17].

15.1 Favorites

All the settings you have marked as favorites will be displayed in the favorites.

Saving settings as favorites

1. Select a setting.

2. Press this button: 

>> The setting will be saved as a favorite. Favorites will be displayed under , sorted chronologically in the order they were added.

15.2 Display

Opening display settings

1. Press this button: 

2. Press this button:  **Display**

15.2.1 Language

Here, you can change the language of the user interface.

Setting the user interface language



1. Press this button:  **Language**

2. Select the desired language.

>> The language of the user interface will be changed immediately.

15.2.2 Date and time

You can change the following settings here:

- **Date**  
- **Time of day**  

- Switch 24h/12h

Setting the date

1. Press this button: **Date**
 - > A calender is shown.
 2. Select the desired date.
- >> The date is applied automatically.

Setting the time

1. Press this button: **Time of day**
 - > The time is shown.
 2. Press the time.
 3. Set the desired time.
- >> The time is applied automatically.

Switching between 24 h/12 h clock formats

1. Select **12** to use a 12-hour clock format and **24** to use a 24-hour clock format.

Synchronizing time via ConnectedCooking

You can also have the time synchronized automatically via ConnectedCooking.

1. Press this button:
2. Press this button: **ConnectedCooking**
3. Next to **automatic time synchronization**, press this button: **ON**

15.2.3 Setting the temperature format

Use this to choose whether to display temperatures in °C or °F.

15.2.4 Program view

Here, you can set whether intelligent cooking paths in the iCookingSuite and in the programming mode should be displayed in a single-column, dual-column or triple-column format.

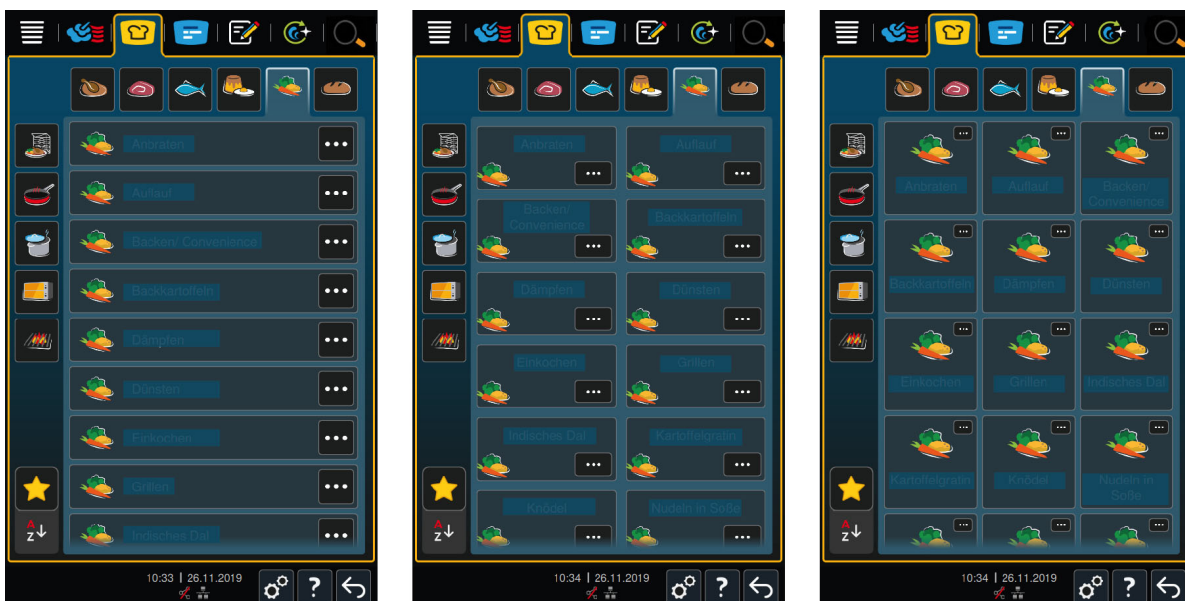



1. Press this button: **Program view**
2. Select **Single-column**, **Two-column**, or **Three-column**.

>> The selection will be applied automatically.

15.3 Light

Adjusting light settings

1. Press this button: 
2. Press this button:  **Light**

15.3.1 Display brightness

Setting display brightness

Here, you can adjust the display brightness on a scale of 0 - 100%.

1. Press this button:  **Display brightness**
2. Select the desired value on the scale or set it using the dial.

>> The display brightness is adjusted automatically.

Automatic dimming

1. Press this button:  **Automatic dimming**

>> You can switch automatic dimming on or off here.

Set dimming after x min

1. Press this button:  **Dimming after x min**

>> Use this setting to specify the number of minutes after which automatic dimming occurs.

Maximum brightness cooking cabinet

1. Press this button:  **Maximum brightness cooking cabinet**

>> Here, you can adjust the display brightness from a scale of 0 - 100 %.

Activating/deactivating the screen saver

1. Press this button:  **Screen saver**

>> Use this setting to switch the screen saver on or off.



Activate screen saver after x min

1. Press this button:  **Activate Screen Saver after x min**

>> Use this setting to specify the number of minutes after which the screen saver is activated.

15.4 Sound

Sound settings

1. Press this button: 
2. Press this button:  **Sound**

15.4.1 Master volume

Master volume settings







Here, you can set the master volume of the unit on a scale of 0– 100 %.

1. Press this button:  **Master volume**
2. Select the desired value on the scale.

>> The master volume is adjusted immediately.







15.4.2 Loading / action requests

This is where you select the sound or melody that the cooking system uses to prompt you to take action or load the cooking system. There are 25 sound options to choose from.

1. Press this button:  **Loading/Action prompt**
2. Press this button:  **Sound**
3. Press the sound you would like to use.
 - > The sound will be played.
4. To turn off sounds, press this button: **OFF**
5. Go to the icon bar and press:  to return to the overview.
6. If you want the sound to play continuously until the cooking system has been loaded or the action has been confirmed, press this button:  **Continuous playback ON**
7. If you only want the sound to play for a certain length of time, press this button:  **Continuous playback OFF**
 - > The  **Tone length** field will be activated.
8. Set the length anywhere between 0 – 180 seconds.
9. To apply the setting, press this button in the icon bar: 
 - >> You will be returned to the overview screen.



15.4.3 Program step end





This is where you select the sound or melody that the cooking system uses to indicate that a program step has been completed. There are 37 sound options to choose from.

1. Press this button:  **End of program step**
2. Press this button:  **Sound**
3. Press the sound you would like to use.
 - > The sound will be played.
4. To turn off sounds, press this button: **OFF**
5. Go to the icon bar and press:  to return to the overview.
6. If you want the sound to play continuously until the cooking system has been loaded or the action has been confirmed, press this button:  **Continuous playback ON**
7. If you only want the sound to play for a certain length of time, press this button:  **Continuous playback OFF**
 - > The  **Tone length** field will be activated.
8. Set the length anywhere between 0 – 180 seconds.
9. To apply the setting, press this button in the icon bar: 
 - >> You will be returned to the overview screen.

15.4.4 End of cooking time







This is where you select the sound or melody that the cooking system uses to signal the end of the cooking time. There are 37 sound options to choose from.

1. Press this button:  **End of cooking time**
2. Press this button:  **Sound**
3. Press the sound you would like to use.
 - > The sound will be played.
4. To turn off sounds, press this button: **OFF**
5. Go to the icon bar and press:  to return to the overview.

6. If you want the sound to play continuously until the cooking system has been loaded or the action has been confirmed, press this button:  **Continuous playback ON**
7. If you only want the sound to play for a certain length of time, press this button:  **Continuous playback OFF**
 - > The  **Tone length** field will be activated.
8. Set the length anywhere between 0 – 180 seconds.
9. To apply the setting, press this button in the icon bar: 
- >> You will be returned to the overview screen.

15.4.5 Process canceled / error detected

This is where you select the sound or melody that the cooking system uses to indicate that an error has been detected. There are 37 sound options to choose from.

1. Press this button:  **Proc. interrupt / Error found**
2. Press the sound you would like to use.
 - > The sound will be played.
3. To turn off sounds, press this button: **OFF**
4. Tap  in the icon bar to return to the overview screen.
5. If you want the sound to play continuously until the cooking system has been loaded or the action has been confirmed, press this button:  **Continuous playback ON**
6. If you only want the sound to play for a certain length of time, press this button:  **Continuous playback OFF**
 - > The  **Tone length** section will be activated.
7. Set the length anywhere between 0 - 180 seconds.
8. To apply the setting, press this button in the icon bar: 
- >> You will be returned to the overview screen.

15.5 Cooking system

1. Press this button: 
2. Press this button:  **Cooking system**

15.5.1 Information on the unit type

Here, you can see the model of your unit and the software version installed.

15.5.2 Power usage

NOTE

Energy consumption information is only available after the cooking process has been completed; it is overwritten when a new cooking process is started. The energy values shown are calculated rather than measured. Measuring instruments may indicate slightly different values to the ones displayed.

You can call up the Energy Dashboard via this menu item. From there, you can monitor your cooking system's energy consumption. Energy consumption is calculated in detail based on the chosen settings; it can also be displayed and evaluated in ConnectedCooking.

Press this button:  to check your cooking system's energy consumption.

The energy consumption display allows you to view the energy consumption of the most recently completed cooking process. The following consumption data is provided after completion of a manual or intelligent cooking process, use of iProductionManager, or cleaning:

- Cooking process duration
- Type of cooking process



- Energy consumption in kWh



15.5.3 iProductionManager energy-saving mode

Press this button:  to switch the IPM energy saving mode on or off.

15.5.4 Screen lock

You can activate or deactivate the control nozzle here:

- To activate the function, press this button:  ON
- To deactivate the function, press this button:  OFF

If activated, the screen can be locked by pressing and holding the  button. This prevents accidental operation, e.g. when wiping the display. The screen lock can be deactivated again by pressing and holding the  button.

15.5.5 Demo mode

Activating/deactivating demo mode

This is used to switch the cooking system to demo mode. Demo mode is useful for viewing cooking system functions without actually cooking.

1. To activate the function, press and hold this button:  ON until the progress bar has moved past the two switch positions (ON and OFF).

>> When demo mode is activated, the cooking system will restart. This symbol will appear in the footer: 

15.5.6 Power steam

Use this setting if, in Steam [▶ 27] cooking mode, you want to ensure a continuous, uninterrupted supply of fresh steam when preparing particularly delicate products.

CAUTION

Working with the Power Steam function will generate a great deal of hot steam

You can be scalded by the hot steam when opening the cooking cabinet door.

1. When working with the Power Steam function, always open the cooking cabinet door carefully.

1. To activate the function, press:  ON

>> In **Steam** cooking mode, the boiling temperature is replaced with this symbol: 

15.5.7 Control nozzle

Use this setting to set whether the cooking system's control nozzle condenses excess steam. This function is standard in eco mode. Adjust this setting in order to optimize escaping steam. In addition to the Eco mode setting, you can activate or deactivate the control nozzle function:





- Activating the control nozzle can be especially useful for preventing undesired condensation in the kitchen.
- Deactivating the control nozzle allows you to save water if your ventilation system is sufficiently powerful.

Consult your RATIONAL service partner before activating or deactivating the function.

1. Press this button:  **Control nozzle**
2. To activate the function, press this button: **ON**
3. To deactivate the function, press this button: **OFF**



15.5.8 Watchdog

Use this setting to specify whether you want a warning signal to sound when the cooking cabinet door is left open too long while the cooking system is being loaded. Set the time anywhere between 0 - 180 seconds.

- Press this button:  to access the watchdog settings.
- Press this button:  to set the number of seconds for watchdog function 1.
- Press this button:  to set the number of seconds for watchdog function 2.
- Press this button:  to set the number of seconds for the watchdog function in programming mode.

15.5.9 Danger

Use this setting to specify whether you want a warning signal to sound when the cooking cabinet door is left open too long during cooking. Set the time anywhere between 0 - 180 seconds.

- Press this button:  to access the Danger settings.
- Press this button:  to set the number of seconds for the Danger function in preheating or the iProductionManager preheating function.
- Press this button:  to set the number of seconds for danger levels in iProductionManager.

15.5.10 Empty steam generator



1. Press this button:  to empty the steam generator.

15.5.11 VarioSmoker

You can activate or deactivate the smoking function regardless of whether you have already connected the VarioSmoker.

1. Press this button:  Use **VarioSmoker ON** or **OFF** to enable the VarioSmoker activation option button in manual programming.

15.6 Cook

1. Press this button: 
2. Press this button:  **Cook**

15.6.1 Primary national cuisine

The primary national cuisine setting translates cultural eating habits into intelligent cooking paths. The cooking parameters in those intelligent cooking paths reflect these cultural eating habits, so dishes are prepared the way that diners in that particular country or region expect. This means that you can master not just local cuisine, but cuisine from anywhere in the world. This setting is independent of the set language.



Selecting a primary national cuisine

1. Press this button:  **Primary national cuisine**
 2. Scroll through the list and select your desired primary national cuisine.
- >> The national cuisine will be applied immediately. The intelligent cooking paths that correspond to the national cuisine will be shown in the iCookingSuite. The cooking parameters in the intelligent cooking paths will be adjusted according to those cultural eating habits.

15.6.2 Secondary national cuisine

You can add an additional national cuisine to the primary national cuisine. This means that you can prepare the typical dishes from 2 countries at the same time. This is an advantage, for example, if you want to offer a special weekly menu with a different national cuisine in your restaurant.

Selecting a secondary national cuisine

1. Press this button:  **Secondary national cuisine**
 2. Scroll through the list and select your desired secondary national cuisine.
- >> The national cuisine will be applied immediately. In the iCookingSuite, additional intelligent cooking paths for the secondary national cuisine will be displayed and marked with . Cooking parameter settings will still be influenced by the primary national cuisine [▶ 64].

15.6.3 A la carte plate weight

Before starting the Finishing step, set how heavy an empty plate is. Based on this information, your iCombi Pro will adjust the cooking steps so that they achieve an ideal Finishing result and so that no moisture forms on the plates. More information is available here: [Set à la carte plate weight \[► 35\]](#)

15.6.4 Banqueting plate weight

Before starting the Finishing step, set how heavy an empty plate is. Based on this information, your iCombi Pro will adjust the cooking steps so that they achieve an ideal Finishing result and so that no moisture forms on the plates. More information is available here: [Setting the banqueting plate weight \[► 35\]](#)

15.6.5 Number of racks



Here, you can set how many racks you want to use in the iProductionManager.

1. Press this button:  **Number of racks**
 2. Select the desired value between 0 - 12.
- >> The setting will be applied immediately.

15.6.6 Order of racks

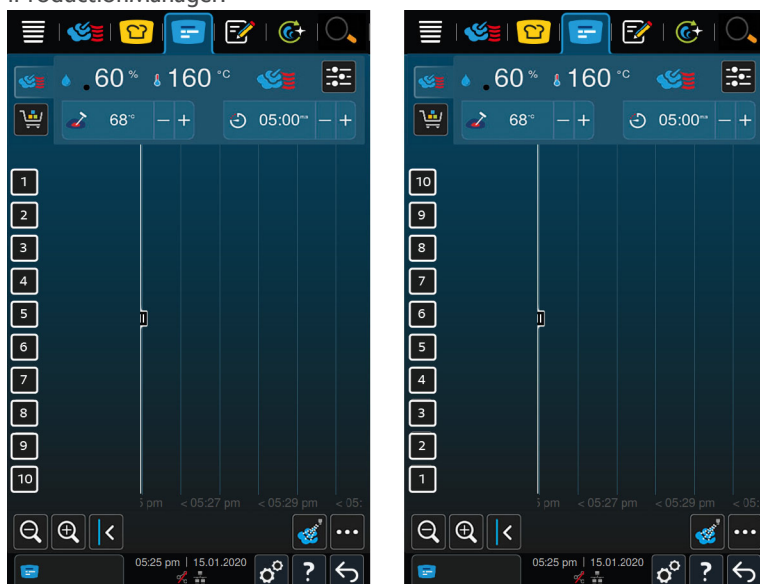
Here, you can set whether the rack order should be shown in ascending or descending order in the iProductionManager.



1. To display the racks in ascending order, press:  **123**
 2. To display the racks in descending order, press:  **321**
- >> The setting is adopted immediately.

15.6.7 Load calculation for manual programs in iProductionManager

Use this setting to specify whether cooking time should be extended on manual programs in iProductionManager when the door is left open during cooking and the measured energy loss is significant enough that the desired cooking results cannot be achieved using the current settings.

1. To activate the function, press this button: **Load calculation for manual programs in iProductionManager ON**

15.6.8 Hold time climate

This setting allows you to specify how long you want the cooking system to maintain the climate within the cooking cabinet when you are not preparing dishes using iProductionManager.

1. Press this button:  **Climate hold time**
2. Select the desired value on the scale.

>> The hold time will be adjusted immediately.

NOTE

A shorter holding time will save energy.

15.6.9 iProductionManager 3D

Use this setting to specify that you want to load two trays per level in iProductionManager. Each tray will be monitored separately. Please note that no more than 12 levels can be displayed at once.

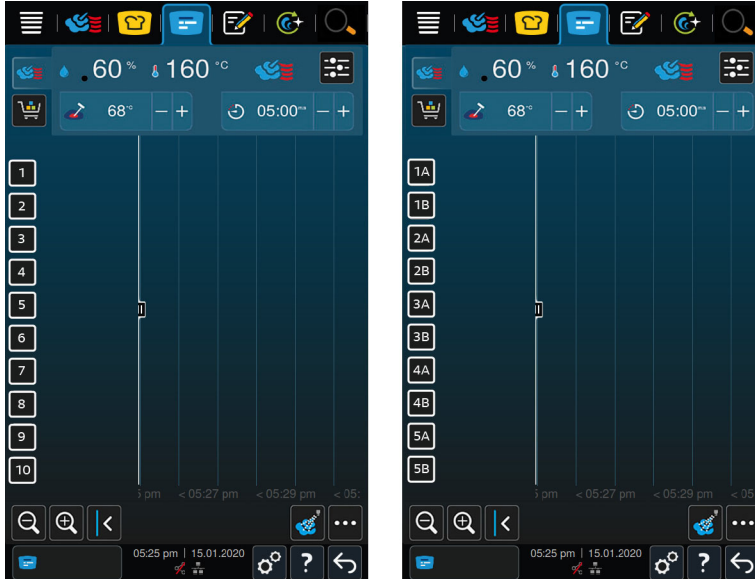

1. To activate the function, press this button: **ON**

>> The setting will be applied immediately.

15.7 Data management

Please note that **Data Management** functions will only be available once you have plugged a USB stick into the unit.

1. Press this button:
2. Press this button: **Data management**

You can change the following settings:

- Export all data [▶ 66]
- Cooking programs [▶ 67]
- User profiles [▶ 67]
- User images [▶ 67]
- User data: Delete all
- Basic cooking system settings [▶ 68]
- HACCP data [▶ 68]
- Service [▶ 68]
- MyDisplay [▶ 69]

15.7.1 Export all data

✓ Start by plugging a USB stick into the cooking system.

1. Press this button: **Export all data**

>> You can now export all data to a USB stick.

15.7.2 Cooking programs

Use this function to export, import or delete all programs you have created.

Export programs

- ✓ Use this function after you have created programs in programming mode.
- ✓ Start by plugging a USB stick into the cooking system.

1. Press this button:  **Export programs**

>> The saved profiles will be saved to the USB stick.

Importing programs

1. Connect a USB stick containing previously exported programs to the cooking system.
2. Press this button:  **Import programs**

>> The saved programs will be imported and displayed in programming mode.

Programs: Delete all own

Use this function to delete all programs you have created.

1. Press this button: 

> You will be prompted to confirm that you really want to delete the programs.

2. To confirm, press this button: 

>> A message will be shown confirming that all programs have been deleted.

15.7.3 User profiles

Exporting profiles

- ✓ Use this feature once you have created profiles.
- ✓ Start by plugging a USB stick into the cooking system.

1. Press this button:  **Export profiles**

>> The saved profiles will be saved to the USB stick.

Importing profiles

1. Connect a USB stick containing previously exported profiles to the cooking system.
2. Press this button:  **Import profiles**

>> The saved profiles will be imported and displayed in the user management area.

15.7.4 User images

Use this screen to import and export any images that you wish to assign to programs or shopping carts. Images must fit the following parameters:

- File type: PNG
- Color depth: 3 x 8 bit
- Image size: 130 x 130 px
- File size: max. 50 KB

Importing images

1. Save the images to a USB stick in a folder named **userpix**.
2. Connect the USB stick to the cooking system.
3. Press this button:  **Import images**

>> The saved images will be imported.

Exporting images

- ✓ Use this function once you have imported images.
- ✓ Start by plugging a USB stick into the cooking system.
- 1. Press this button:  **Export images**
- >> The stored images will be saved to the USB stick.

Deleting all own images

Use this function to delete the images you have imported.

- 1. Press this button: **Delete all own images**
 - > You will be prompted to confirm that you really want to delete the images.
- 2. To confirm, press this button: 
- >> A message will be shown confirming that all of your own images have been deleted.

15.7.5 Basic cooking system settings**Basic cooking system settings: Export all**

- ✓ Start by plugging a USB stick into the cooking system.
- 1. Press this button:  **Basic cooking system settings: Export all**
- >> The basic system settings will be saved to the USB stick.

Importing basic cooking system settings

- 1. Connect a USB stick containing previously exported basic system settings to the cooking system.
- 2. Press this button:  **Basic cooking system settings: Import all**
- >> The basic settings will be imported.

15.7.6 HACCP data

Here, you can export the HACCP data recorded by the unit to a USB stick. You can also have the HACCP data sent automatically to ConnectedCooking.

HACCP data: Export all

- ✓ Start by plugging a USB stick into the cooking system.
- 1. Press this button:  **HACCP data: Export all**
- >> The HACCP data is saved on the USB stick.

HACCP data: Export for time period

- ✓ Start by plugging a USB stick into the cooking system.
- 1. Press this button:  **HACCP data: Export for time period**
- 2. Select the desired time period and press the "Export" button.
- >> HACCP data for the selected period will be saved to the USB stick.

15.7.7 Service**Developer protocol: Export all**

- ✓ Start by plugging a USB stick into the cooking system.
- 1. Press this button:  **Developer protocol: Export all**
- >> The developer logs will then be downloaded to a USB stick.

Developer protocol: Export for time period

✓ Start by plugging a USB stick into the cooking system.

1. Press this button:  **Developer protocol: Export for time period**

>> You can now download the developer logs for a certain period of time.

Service reports: Export all

✓ Start by plugging a USB stick into the cooking system.

1. Press this button:  **Service reports: Export all**

>> The service reports will now be downloaded to a USB stick.

Exporting error statistics logs



✓ Start by plugging a USB stick into the cooking system.

1. Press this button:  **Copying error statistics log to a USB stick**

>> The error statistics log is saved on the USB stick.

15.7.8 MyDisplay

Use the **MyDisplay** option to export chain scripts installed on the cooking system, for example to transfer profiles, programs, or images to a different cooking system. Before exporting, you can use the **Delete before updating** toggle switch to specify whether any existing programs, profiles and images should be deleted when the chain script is imported.

- Press this button:  to delete previously installed programs, profiles and images before importing.
- Press this button:  to export your MyDisplay configurations to a USB stick.

15.8 Network settings

NOTE

Cybersecurity hazards

The unit is a networkable cooking system with digital controls, user interface, and software integration. To ensure cybersecurity, data protection, and safe operation, be mindful of the following:







1. Only authorized, trained personnel may configure and maintain the cooking system.
2. Perform the regular software updates RATIONAL provides. Use only signed and authenticated software. Non-approved software usage is prohibited and could jeopardize security.
3. Only connect the cooking system to secure networks (e.g. WPA2/WPA3 for WLAN, VLAN for LAN). Always use encrypted connections (e.g., HTTPS) to communicate with RATIONAL ConnectedCooking or other services.
4. All forms of manipulation or unauthorized modification of the cooking system software, hardware, or network configuration are prohibited; doing so will compromise operational security and invalidate warranty and liability claims.
5. Responsibility for integrating the cooking system securely into your IT infrastructure lies with the operator. The manufacturer is not liable for damage resulting from improper use, insufficient protection, or access by unauthorized persons.

If necessary, you can enable **NTP-based** time synchronization in the system settings. If **NTP** is enabled, the customer must ensure that a trusted, secure **NTP** server is available.



- The **NTP** server must come from a reliable, controlled **NTP** environment to ensure accurate, tamper-proof time data.
- **NTP** server communication must be secured using protected network segments and suitable firewall rules.

Connecting the unit to a wireless network that requires you to log in via a website will not allow the unit to establish a wireless connection. It is not possible to connect to Wi-Fi networks that require login via a website.

1. Press this button: 

2. Press this button:  **Network**
 3. To activate the function, press this button:  **ON**
 4. Press this button:  **WiFi**
 - > A list of all available wireless networks is shown. Wireless networks will be shown in descending order of signal strength.
 5. Select the wireless network you wish to use.
 - > You will be prompted to enter the password for the wireless network.
 6. To confirm, press this button: 
 - > Once the connection has been established successfully, the following symbol appears in the footer: 
 - > The wireless network will be displayed at the top of the list of available wireless networks.
 7. To view connection details, click this button beside the wireless network: **V**
 8. To disconnect from the network, go to the connection details and press this button: **Disconnect**
 9. Tap  in the icon bar to return to the network settings overview screen.
- >> The name of the wireless network will be displayed in the **Wireless network** section.

Optimized network settings allow you to connect to wireless networks with hidden SSIDs:

- Press this button:  **Manual WiFi connection.**
- You can now enter the network name (**SSID**) and the associated password.
- Press this button:  to connect.



1. Press this button: 
2. Press this button:  **Network settings**

You can find out how to connect your unit to a WiFi network here: [Connecting to WiFi \[▶ 78\]](#)

You can find out how to connect your unit to a network here: [Connecting to a network \[▶ 79\]](#)

Starting the network wizard

The Network Wizard helps you set up your network settings.

1. Press this button:  **Start network wizard**
 - > You will then be asked whether you want assistance with network settings. The Wizard can help you set up either a wireless connection or a LAN connection.
2. Press this button:  **IP DHCP active: OFF** will allow you to edit the following network settings:
 - **IP address**
 - **IP gateway**
 - **IP net mask**
 - **DNS 1**
 - **MAC address**
1. Press this button:  **IP DHCP active: ON** will allow you to edit the following network settings:
 - **MAC address**

You can run network diagnostics to help troubleshoot connection issues.

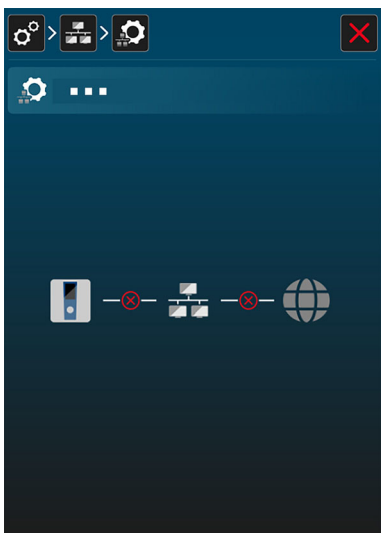

1. Press this button:  *Perform network diagnostics* to see if your cooking system is connected to the network.



The **Network status** button can be used to check whether the cooking system is connected to the router and the Internet.

15.9 User profile



You can compile users to profiles and assign access authorizations to these profiles. By default, your cooking system is assigned a profile that cannot be deleted. You can add up to 10 additional profiles.

1. Press this button: 
2. Press this button:  **User profile**

You can find out how to create and edit profiles and transfer them to other cooking systems here: [Managing profiles and permissions](#)

15.9.1 Activate profile

✓ You have created a profile. See also [Create new profile](#)

1. Press this button:  **Activate profile**
2. Select the desired profile.
3. If you have assigned a password to the profile, enter the password.
4. To confirm, press this button: 

>> The profile will be activated immediately.

>> The activated profile will be shown when you open the home screen. If you have displayed multiple profiles, you can scroll through the list.

>> To create a new profile, press this button:

>> You will now be taken to the profile settings.



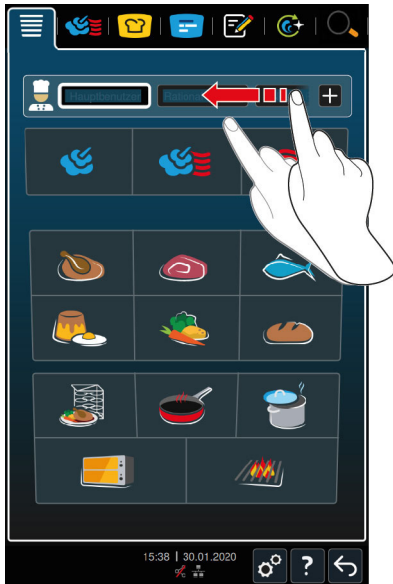





>> Press this button: [Create new profile](#).



15.9.2 Edit profile









- ✓ You have created a profile.
- 1. Press this button:  **Edit profile**
 - > You can now select a profile to be edited.

Profile settings

- 1. Press this button:  **Profile settings**.
- >> You can now edit the following settings:
 -  **Edit profile name**
 -  **Edit profile password**
 -  **Change language**
 -  **Change profile type NOTE! The profile type can only be changed by the primary user.**
 -  **Change primary national cuisine**
 -  **Change secondary national cuisine**
 -  **Delete profile**
 -  **Hide all elements except favorites** can be switched on or off.

Adjusting the menu bar

This option allows you to customize the menu bar to your liking.

- 1. Press this button:  **Adjusting the menu bar**
- >> You can change the following settings:
 -  The **start screen** can be shown or hidden.
 -  **Manual operating modes** can be shown or hidden.
 -  **iCookingSuite** can be shown or hidden.
 -  **iProductionManager** can be shown or hidden.
 -  **Programming mode** can be shown or hidden.
 -  **iCareSystem** can be shown or hidden.
 -  **Search assistant** can be shown or hidden.

Creating and editing display screens

1. Press this button: **ON** or **OFF**, the option : **Create and edit screen** to enable or disable the Create new screen [▶ 74] option.







Edit footer

1. Press this button:  **Edit footer**.
- >> Now you can set whether the **? Cooking system help function** is shown or hidden in the footer.





















Change profiles

1. Press this button: **ON** or **OFF**, the Option:  **Change** to activate or deactivate the ability to change between profiles

Adjusting iCookingSuite

1. Press this button:  **iCookingSuite**
- >> You can now change the following settings:
-  **Parameter permissions**. Here, you can choose between **operable** and **not visible**.
 -  **Humidity** can be shown or hidden.
 -  **Cooking cabinet temperature** can be shown or hidden.
 -  **Core temperature** can be shown or hidden.
 -  **Cockpit header** can be shown or hidden.

iProductionManager

1. Press this button:  **iProductionManager**
- >> You can now change the following settings:
-  **À la carte mode** can be shown or hidden.
 -  **Manual ticket board** can be switched on or off.
 -  **Time ticket** can be shown or hidden.
 -  **Edit ticket board** can be shown or hidden.
 -  **Allow drag-and-drop** can be shown or hidden.
 -  **Ticket combinability** can be shown or hidden.
 -  **Allow level assignments** can be shown or hidden.
 -  **Place at actual time** can be shown or hidden.
 -  **Allow subsequent drag-and-drop** can be shown or hidden.
 -  **Allow pop-over access** can be shown or hidden.
 -  **Clone tickets** can be shown or hidden.
 -  **Jump to current time** can be shown or hidden.
 -  **Positioning aid** can be shown or hidden.
 -  **Allow scrolling** can be shown or hidden.
 -  **Zoom** can be shown or hidden.
 -  **Steam injection** can be shown or hidden.
 -  **Preheat** can be shown or hidden.
 -  **Close planning gaps** can be shown or hidden.
 -  **Time optimization** can be shown or hidden.
 -  **Energy optimization** can be shown or hidden.

See also



- 📄 Add profile [▶ 74]

15.9.3 Add profile

Here you can add a new profile.

1. Press this button:  **Add profile**

>> You can now add a new profile.

1. Press this button:  **from an existing profile** to create a profile based on an existing one. You can now change settings for the newly added profile under the  **Edit profile** [▶ 72] menu item.
2. Press this button:  **from a profile template** to create a new profile using a profile template.

15.9.4 Edit display







- ✓ Create a new display before using this function.

1. Press this button:  **Edit screen**

> The functions and intelligent assistants on the menu bar will be displayed.

2. Press the desired button.

> All available functions will be displayed.

- Within the  **Manual Cooking** section, you have access to the  **Steam**,  **Combination** and  **Hot Air** cooking modes.
- You can access all intelligent cooking paths within the  **iCookingSuite** section.
- All manual and intelligent programs as well as shopping carts are available to you within the  **Programming Mode** section. If you have not yet saved any programs or shopping carts, this section will be empty.
- Within the  **iCareSystem** section, you have access to all Cleaning modes [▶ 82] and Cleaning programs [▶ 83].

1. Tap each function you would like to assign to the display menu.

> The function will be marked with .

2. To check the list of functions on the display menu, press this button: 

3. To remove a function from the display menu, press this button: 

4. To give the display menu a name, press this button: 

5. Enter a name.

6. To save the display menu, press this button: 

>> You will be returned to the overview screen.

1. To assign the display menu to a profile, press this button:  **Edit profile**

2. Select the desired profile.

3. Press this button:  **Customize menu bar**

4. Press this button, which is behind the on-screen menu: **ON**

5. Tap  in the icon bar to return to the user profile overview screen.

>> Profile activation [▶ 71] will result in the new display menu being shown in the menu bar.

15.9.5 Create new screen

1. Press this button: 



2. Press this button: 

3. Press this button: 









4. You can now customize your display using the **Display editor**.

5. Tap each function you would like to add to / remove from the MyDisplay menu.
6. To name your screen, enter a title in the text field.
7. To save your changes, press this button: 

15.10 Service

1. Press this button: 
2. Press this button:  **Service**

The following information is available:

- Information on cooking system model/software version 
- Serial number information 
- Hotline - Chef [▶ 105] 
- Hotline - Service [▶ 105] 
- Service level 
 - This function is only available to RATIONAL service partners.
- Software update info [▶ 75] 
- Installed software version [▶ 75]
- Service messages of the last 14 days 
- Open source licenses 

15.10.1 Installed software version

Here, you will find all information on the installed software version and installed help packages.

15.10.2 Software update info

Here, you can see which software version is installed on your unit. If you have connected your unit with ConnectedCooking and activated the function **Download software updates automatically**, the software updates are made available automatically. More information is available here: Run software updates automatically [▶ 81] If a software update is available, the current software version is shown and the **Start installation** button is active.

1. Press this button: **Start installation**
- >> The software update is carried out and the unit is rebooted.

15.11 ConnectedCooking

NOTE

If no activation code is displayed, it is not yet possible to connect to the ConnectedCooking server.

Check the following:

- DNS name resolution for www.connectedcooking.com.
- Variant with DHCP: DHCP active – network-assigned IP address.
- Version without DHCP: network operator must provide IP address, network mask, gateway, DNS server - can then be entered manually on the cooking system.
- Firewall ports 443 and 8883 free (protocol: HTTPS and MQTT) for outgoing communication to destination host: www.connectedcooking.com (IP 185.113.124.8)
- Networks with MAC filter: MAC addresses can be read out on the combi-steamer or requested via customer service *These settings correspond to the default settings of a home router

1. Press this button: 
2. Press this button:  **ConnectedCooking**

To learn how to connect your cooking system to ConnectedCooking and discover the available functions, go here: ConnectedCooking [▶ 80]

When your cooking system is connected to ConnectedCooking, you have the following setting options.

1. Press this button: 

>> You can log in to ConnectedCooking with your existing account.

1. Press this button: 

>> You can log in anonymously to ConnectedCooking without an account.

Automatic time synchronization

1. Press this button:  **ON** or **OFF**

>> Press **OFF** to prevent automatic time synchronization. Press **ON** to synchronize the time automatically.

Transfer HACCP data automatically

1. Press this button:  **ON** or **OFF**

>> Press **OFF** if you do not want your cooking system to automatically transfer HACCP data to ConnectedCooking. As soon as you press the **ON** button, the cooking system will automatically begin transferring HACCP data to ConnectedCooking.

Remote access

1. Press this button:  **ON** or **OFF**

>> Press **OFF** to make remote access unavailable. Press **ON** to allow your cooking system to be controlled remotely through ConnectedCooking.

Software updates

1. Press this button:  **ON** or **OFF**

>> Press **OFF** to prevent automatic software updates. Press **ON** if you want software updates to be performed automatically.

Connect automatically

If your cooking system loses network connectivity, the unit will automatically reconnect to ConnectedCooking once connectivity is restored. If you do not want this, you can deactivate the function.

1. Press this button:  **ON** or **OFF**

>> Your cooking system will disconnect from ConnectedCooking when you press **OFF**. When you press **ON**, your cooking system will automatically re-connect to ConnectedCooking

Log off

You can log a cooking system off ConnectedCooking at any time. Connection details will be deleted. To re-connect the cooking system to ConnectedCooking, you will need to register it again.

1. Press this button: 

>> You will be asked to confirm whether you really want to log off ConnectedCooking. Once you have provided confirmation, your unit will be logged out of ConnectedCooking immediately.

16 Kitchen management

16.1 Hygiene management

16.1.1 Recorded HACCP data

The following HACCP data is recorded for each batch:

- Batch number
- Cooking system model
- Serial number
- Software and help version
- Date and time
- cleaning program
- Rinse hand shower
- Cooking cabinet temperature
- Target core temperature
- Measured core temperature
- Time (hh.mm.ss)
- Temperature unit
- Connection to energy optimization system
- Name and ID of the cooking path
- Opening / shutting of cooking cabinet door
- Change cooking mode
- Automatic cleaning



16.1.2 Exporting HACCP data

HACCP data is stored on the cooking system for up to 14 days at maximum usage. You can download that data during this period. More information is available here: Export HACCP data. [▶ 68] If the cooking system is used less frequently, the data will be available for a longer period.

16.1.3 Transmitting HACCP data to ConnectedCooking automatically

If your unit is connected to ConnectedCooking, you can set it to transmit HACCP data to ConnectedCooking automatically when a cooking path finishes.

✓ Start by connecting your unit to ConnectedCooking [▶ 80].

1. Press this button: 
2. Press this button:  **ConnectedCooking**
3. Next to **Transfer HACCP data automatically**, press the button:  **ON**

>> Now HACCP data will be transmitted automatically upon completion of each cooking path. You can view that data on connectedcooking.com or through the ConnectedCooking app.

16.2 Connecting units to a network

The following options are available when you network your unit:

- Operate both units of a Combi-Duo installation on just one unit.
- Connect the units with ConnectedCooking.

NOTE**Cybersecurity hazards**

The unit is a networkable cooking system with digital controls, user interface, and software integration. To ensure cybersecurity, data protection, and safe operation, be mindful of the following:







1. Only authorized, trained personnel may configure and maintain the cooking system.
2. Perform the regular software updates RATIONAL provides. Use only signed and authenticated software. Non-approved software usage is prohibited and could jeopardize security.
3. Only connect the cooking system to secure networks (e.g. WPA2/WPA3 for WLAN, VLAN for LAN). Always use encrypted connections (e.g., HTTPS) to communicate with RATIONAL ConnectedCooking or other services.
4. All forms of manipulation or unauthorized modification of the cooking system software, hardware, or network configuration are prohibited; doing so will compromise operational security and invalidate warranty and liability claims.
5. Responsibility for integrating the cooking system securely into your IT infrastructure lies with the operator. The manufacturer is not liable for damage resulting from improper use, insufficient protection, or access by unauthorized persons.

If necessary, you can enable **NTP-based** time synchronization in the system settings. If **NTP** is enabled, the customer must ensure that a trusted, secure **NTP** server is available.



- The **NTP** server must come from a reliable, controlled environment to ensure accurate, tamper-proof time data.
- **NTP** server communication must be secured using protected network segments and suitable firewall rules.

16.2.1 Establish WLAN connection

Connecting the unit to a wireless network that requires you to log in via a website will not allow the unit to establish a wireless connection. It is not possible to connect to Wi-Fi networks that require login via a website.

1. Press this button: 
 2. Press this button:  **Network**
 3. To activate the function, press this button: 
 4. Press this button:  **WiFi**
 - > A list of all available wireless networks is shown. Wireless networks will be shown in descending order of signal strength.
 5. Select the wireless network you wish to use.
 - > You will be prompted to enter the password for the wireless network.
 6. To confirm, press this button: 
 - > Once the connection has been established successfully, the following symbol appears in the footer: 
 - > The wireless network will be displayed at the top of the list of available wireless networks.
 7. To view connection details, click this button beside the wireless network: **V**
 8. To disconnect from the network, go to the connection details and press this button: **Disconnect**
 9. Tap  in the icon bar to return to the network settings overview screen.
- >> The name of the wireless network will be displayed in the **Wireless network** section.

Optimized network settings allow you to connect to wireless networks with hidden SSIDs:

- Press this button:  **Manual WiFi connection.**
- You can now enter the network name (**SSID**) and the associated password.
- Press this button:  to connect.

16.2.2 Connecting the network cable

Your unit is equipped with a network connection as standard. To connect your unit with the network and to ensure that your unit is protected from water jets from all directions, use a network cable with the following properties:

- Network cable category 6
- Maximum plug length of 45 mm
- Plug diameter of 18.5 mm
- Cable diameter of 5.5 – 7.5 mm

⚠ CAUTION

The function parts around the network connection can reach temperatures of over 140 °F

You may burn yourself when connecting a network cable to a unit that is currently in use or that was recently in use.

1. Allow the unit to cool down before connecting the network cable.

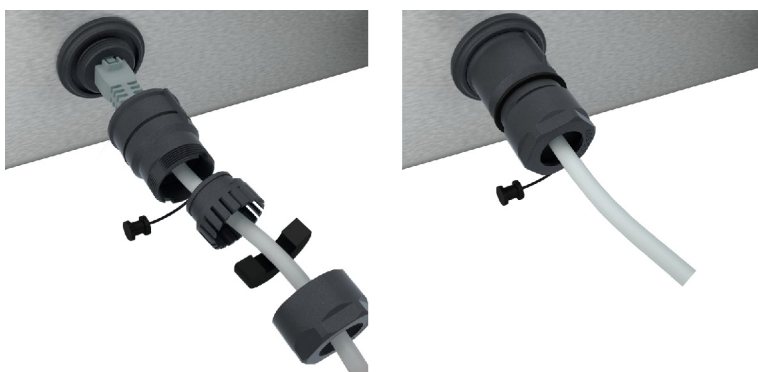

1. Unscrew the protective cover.
2. Feed the individual parts of the protective cover onto the network cable.
3. Connect the network cable to the network connection.
4. Screw on the protective cover.

16.2.3 Establish network connection

✓ Make sure you have all network connection data on hand.

1. Press this button:
2. Press this button: **Network settings**
3. Press this button: **LAN**
4. Press this button: **IP network**
5. Enter the IP address.
6. Press this button: **IP gateway**
7. Enter the IP gateway address.
8. Press this button: **IP subnetmask**
9. Enter the IP subnetmask.
10. To assign the network configuration to clients via a server, activate DHCP. Press this button: **IP DHCP ON**
 - > IP address, gateway and DNS will now be configured automatically.
11. Press this button: **IP DNS 1 (primary)**
12. Enter the DNS server address.

16.3 ConnectedCooking

ConnectedCooking is RATIONAL's state-of-the-art networking solution. Whether you own one RATIONAL cooking system or several, ConnectedCooking opens up a wealth of new and convenient possibilities. All you have to do is connect your RATIONAL cooking system to a network and then visit connectedcooking.com to register.

In ConnectedCooking, you can see the online status, cleaning details, operating statistics and whether HACCP specifications are complied with at a glance. The following features are also available:

- **Push notifications**

Any time a cooking system is ready to load, finishes a cooking process, or needs service, you'll receive real-time information no matter where you are.

- **Transfer and manage cooking paths**

Transfer tried-and-tested cooking paths automatically to all units in your business.

- **Automatic software updates**

Software updates are always provided automatically and at no cost to you.

At connectedcooking.com, you will also find extensive recipe libraries, tips and tricks from our professionals and a wide range of how-to videos

16.3.1 Connect the unit with ConnectedCooking

Once you connect your cooking system to ConnectedCooking, the following features will be available:

- Transmitting HACCP data to ConnectedCooking automatically [► 77]
- Transmitting service data to ConnectedCooking automatically [► 106]

Operate the unit remotely via ConnectedCooking

- Monitor device display remotely

✓ Make sure you have established a network connection.

✓ Make sure you have registered on connectedcooking.com.

1. Press this button: 
2. Press this button: **ConnectedCooking**
3. In the first tab, select a server to use for the connection. You can choose between the international server, **iot.com**, and the Chinese server, **iot.cn**.
4. Log in using your ConnectedCooking account.
 - > Enter your registration details or select registration via QR code.
5. Press this button beside **Connect: Log in**
 - > After a few moments, a nine-digit PIN and a QR code will be displayed. If you do not have a smartphone available, you can register through www.connectedcooking.com. If you have a smartphone available, you can scan the QR code.
6. Alternatively, you can use the auto-registration feature, but then only the basic features will be available to you.

Registration without smartphone

1. Note down the PIN.
 2. Log into www.connectedcooking.com.
 3. Click this symbol: **Cooking system management**
 4. Select: **Cooking systems overview**
 5. Click this symbol: Red circle with +
 6. Enter a cooking system name under **Name**.
 7. Under **Activation key**, enter the PIN showed on the cooking system display.
- >> After a few moments, the cooking system will be displayed on ConnectedCooking's cooking systems overview screen.







- >> The display will indicate that a connection has been established between the cooking system and the ConnectedCooking server. This symbol will appear in the footer: 
- >> You will receive an email confirming that the cooking system has been registered successfully.

Registration with smartphone

- ✓ Make sure you have a QR code scanner app installed on your smartphone.
- ✓ Make sure you have the ConnectedCooking app installed on your smartphone.
- 1. Scan the QR code.
- >> After a few moments, the cooking system will indicate that a connection has been established to the ConnectedCooking server. This symbol will appear in the footer: 
- >> The cooking system will appear on the ConnectedCooking cooking systems overview screen.
- >> You will receive an email confirming that the cooking system has been registered successfully.

16.4 Run software update

Automatic software updates via ConnectedCooking

- ✓ Start by connecting your unit to ConnectedCooking.
- 1. Press this button: 
- 2. Press this button:  **ConnectedCooking**
- 3. To activate the **Download software updates automatically** function, press the button:  **ON**
- 4. Press this button: 
- 5. Press this button:  **Service**
- 6. Press this button:  **Software update info**
- 7. Press this button: **Start installation**
- >> The software update is carried out and the unit is rebooted.

Software update via USB stick

- ✓ You have connected a USB stick containing a software update to the unit.
- ✓ A message appears informing you that a software update has been detected.
- 1. Confirm the message that a software update should be carried out.
- >> The software update is carried out and the unit is rebooted.

17 Automatic cleaning - iCareSystem



The iCareSystem is the intelligent cleaning and descaling system in the iCombi Pro. It recognises how dirty the unit is and proposes the ideal cleaning program and the optimal quantity of care products.

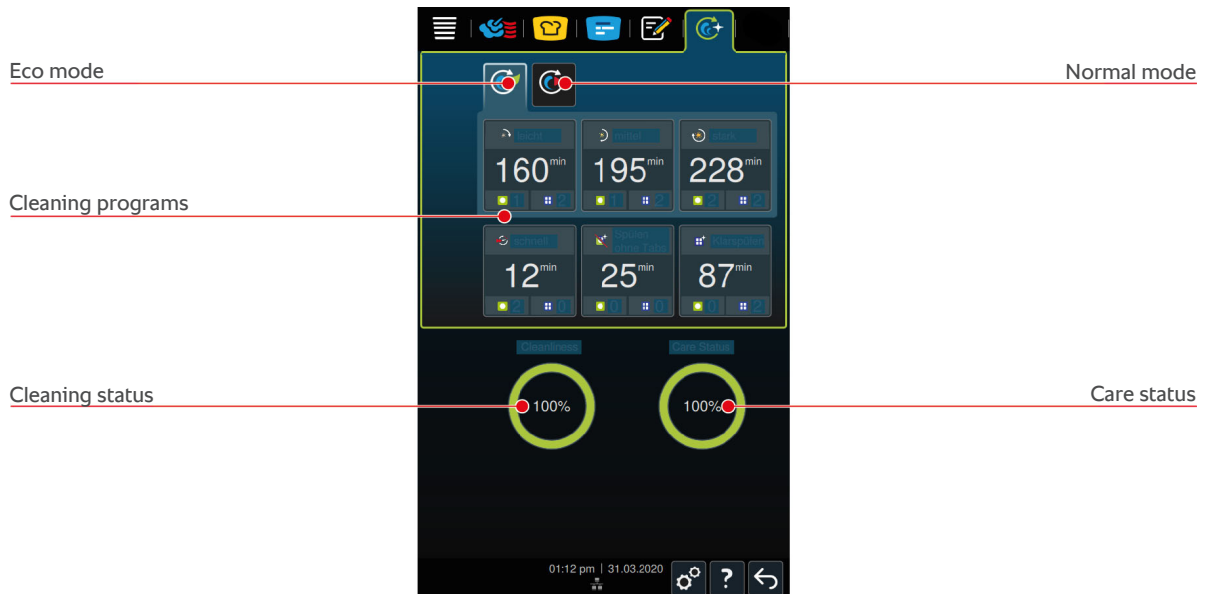

17.1 General safety information

- Only use the manufacturer's recommended Active Green cleaner tabs and care tabs in automatic cleaning.
- Do not use red cleaners.

To avoid scalding and burn injuries:

- Allow the cooking system and all functional components to cool down before starting automatic cleaning.

To avoid severe chemical burns:

- Cleaning and care products can cause severe eye damage and chemical burns to the skin. Always wear securely fitting safety eyewear and chemical-resistant gloves when cleaning the unit.
- Keep the cooking cabinet door closed during automatic cleaning. Otherwise, hot steam and corrosive cleaning chemicals could escape. If you open the cooking cabinet door during automatic cleaning, a message will appear prompting you to close it again.
- Make sure the core temperature probe is not hanging out of the cooking system while automatic cleaning is in progress. This could damage the seal on the cooking cabinet door and allow corrosive cleaning chemicals to escape.
- Do not clean the externally attached core temperature probes using automatic cleaning.
- Before preheating the cooking system for use, remove all cleaning products and cleaning product residues.

How to respond if you come into contact with cleaning chemicals:

- If you touch cleaning agents when not wearing gloves or your skin otherwise comes into contact with Active Green cleaner tabs, rinse your skin with running water for 10 minutes.
- If you get cleaning chemicals into your eyes, rinse your eyes with running water for 15 minutes. Remove your contact lenses, if applicable.
- If you swallow cleaning chemicals, rinse your mouth out with water and drink two glasses of water immediately. Do not induce vomiting.
- Call the poison control hotline or a doctor immediately.

17.2 Cleaning modes

The **light**, **medium** and **strong** cleaning programs can be used in two different cleaning modes:



Eco mode

If you select this cleaning mode, cleaning programs [▶ 83] will use less cleaning chemicals and water to clean the cooking system, but cleaning will take longer than it does in Normal mode.



Normal mode

If you select this cleaning mode, cleaning programs [▶ 83] will use more cleaning chemicals and water to clean the cooking system, but they will be shorter than in Eco mode.

17.3 Cleaning programs

The following cleaning programs are available to you:

Program	Mode	Description	Care product
Light	Eco / Normal	Suitable for removing minor food residue and limescale accumulated when using the cooking system at temperatures of up to 200°C.	<ul style="list-style-type: none"> ▪ Active Green cleaner tabs ▪ Care tabs
medium	Eco / Normal	Suitable for removing stains and limescale that have accumulated during cooking paths involving grilling or frying.	<ul style="list-style-type: none"> ▪ Active Green cleaner tabs ▪ Care tabs
strong	Eco / Normal	Suitable for removing heavy soiling or significant limescale buildup that has occurred during cooking paths involving grilling or frying.	<ul style="list-style-type: none"> ▪ Active Green cleaner tabs ▪ Care tabs
fast	–	Suitable for interim cleaning, to remove heavy soiling quickly. This cleaning program does not reset the forced cleaning timer.	<ul style="list-style-type: none"> ▪ Active Green cleaner tabs
Rinse w/o tabs	–	Suitable for removing water-soluble dirt and grime. This cleaning program does not reset the forced cleaning timer.	–
Rinse	–	Suitable for removing stains containing limescale that occur during cooking paths involving baking or steaming.	<ul style="list-style-type: none"> ▪ Care tabs



TIP

If your cooking system is connected to soft water, you should set the soft water switch to "Soft water".

17.4 Cleaning and care status

iCareSystem automatically detects your unit's cleaning and care status.

Cleaning status

- When the indicator is green, the unit is clean.
- When the indicator is yellow, the unit is dirty, but you can continue using it to prepare food until you are prompted to run a cleaning program.
- When the indicator is red, the unit is very dirty. Start a cleaning program as soon as possible - no later than the next time you are prompted to run a cleaning program.

Care status

- When the care status indicator is green, the steam generator is free of limescale.
- When the indicator is yellow, the steam generator has a small amount of limescale buildup.

- When the indicator is red, the steam generator has a great deal of limescale buildup. Start a cleaning program as soon as possible - no later than the next time you are prompted to run a cleaning program.

17.5 Starting automatic cleaning

- ✓ The hinging racks are correctly placed in the cooking cabinet.
 - ✓ Make sure the mobile rack is placed correctly within the cooking cabinet. **NOTE! The locking brake must not be activated on the mobile rack.**
1. In the menu bar, press this button: 
 2. Select the desired cleaning program [▶ 83].
 - > With almost all cleaning programs, the cool-down function starts automatically if the cooking cabinet temperature is above 90°C.
 3. Open the cooking cabinet door.
 4. Remove any containers and trays from the cooking cabinet. **⚠ WARNING! Danger of burns! Wear safety gloves when removing trays and containers from the cooking cabinet.**



5. Unwrap the indicated number of Active Green cleaner tabs and place them into the floor drain sieve. **⚠ WARNING! Danger of chemical burns! Wear tight-fitting protective glasses and chemical-safe gloves for reliable protection when handling Active Green cleaner tabs and care tabs.**
 6. Unwrap the indicated number of Care tab packages and place them into the care drawer.
 7. Close the cooking cabinet door.
- >> Automatic cleaning will start.
- >> When automatic cleaning is finished, a signal tone will sound.



TIPS



- If foam builds up in the cooking cabinet even though you have used the recommended number of Active Green cleaner tabs, use fewer tabs the next time you run automatic cleaning. If foam continues to build up, please contact your RATIONAL Service Partner.

See also

 Additional functions [▶ 26]

17.6 Canceling automatic cleaning

You can cancel all automatic cleaning programs at any time.



1. Press this button: 
 - > You will be asked if you really want to cancel cleaning. The display will indicate how long cancellation will take.
 2. Press this button: 
 - > Remove the Active Green cleaner tabs.
 3. Open the cooking cabinet door.
 4. **⚠ WARNING! Danger of chemical burns! Wear close-fitting protective goggles and chemical-resistant gloves to protect yourself reliably when working with Active Green cleaner tabs.** Remove the Active Green cleaner tabs from the cooking cabinet and dispose of them.
 5. Rinse the cooking cabinet with water to eliminate any remaining Active Green cleaner tab residue.
 6. Close the cooking cabinet door.
 - > Cancellation will proceed.
 - > Once cancellation has finished, you will be prompted to check the cooking cabinet for Active Green cleaner tab residue.
 7. Open the cooking cabinet door.
 8. Close the cooking cabinet door.
- >> After that, the cooking system is ready for use again. The home screen will appear.

**TIP**

If a power failure occurs during automatic cleaning, automatic cleaning will be interrupted. Once power has been established again, automatic cleaning will resume.



17.7 Forced cleaning after operating hours

If you have activated forced cleaning, you will be prompted to clean the cooking system after a defined time. You can only continue working with the cooking system once cleaning is complete.

1. Press this button: 
 2. Press this button:  **Cleaning**
 3. Press this button:  **Forced cleaning**
 4. To activate forced cleaning, press this button: **ON**
 5. To set the time after which you want to be prompted to clean the cooking system, press this button: **Time to cleaning request** Please note that this time represents how long the cooking system has been in operation, not how much total time has passed.
 6. Set the time anywhere between 1– 24 hours.
 7. To set the number of hours by which cleaning can be postponed following a prompt, press this button: **Forced cleaning delay time**
 8. Set the time anywhere between 1 – 24 hours.
- >> The footer will indicate how many hours of operation are left until cleaning will be required.

17.8 Cleaning schedule

Use a cleaning schedule to specify the weekdays on which you want forced cleaning [▶ 85] to occur. If you have activated forced cleaning, no cleaning schedule can be created.

1. Press this button: 
2. Press this button:  **Cleaning**

3. Press this button:  **Cleaning schedule**
4. In order to define how the cooking system behaves when a cleaning request is issued, press this button: **Scheduled cleaning time**
5. If you do not want to be notified when the scheduled cleaning time arrives, press this button: **OFF**
6. If you want a warning to be displayed at the scheduled cleaning time, press this button: **Warning**
7. To specify that cleaning must be done immediately when a cleaning request is displayed, press this button: **Force**
8. Tap in the icon bar to return to the cleaning schedule overview screen.
9. Select the day of the week on which you want cleaning to occur.
10. Press this button: **ON**
11. Set the time at which you want cleaning to occur.
12. Tap in the icon bar to return to the cleaning schedule overview screen.

18 Automatic cleaning - iCareSystem AutoDose



The iCareSystem is the intelligent cleaning and descaling system in the iCombi Pro. It recognises how dirty the unit is and proposes the ideal cleaning program and the optimal quantity of care products.

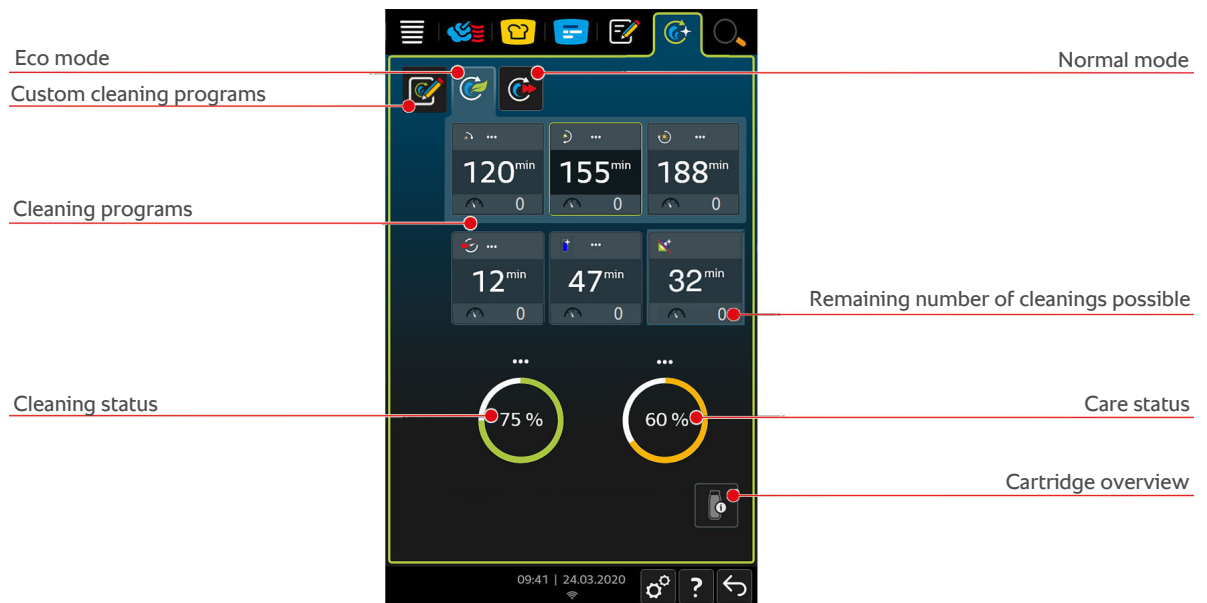

18.1 General safety information

- Only use the manufacturer's recommended Active Green cleaner tabs in automatic cleaning.
- Do not connect a hose to the emergency overflow.

To avoid scalding and burn injuries:

- Allow the cooking system and all functional components to cool down before starting automatic cleaning.

To avoid severe chemical burns:

- Cleaning and care products can cause severe eye damage and chemical burns to the skin. Always wear securely fitting safety eyewear and chemical-resistant gloves when cleaning the unit.
- Keep the cooking cabinet door closed during automatic cleaning. Otherwise, hot steam and corrosive cleaning chemicals could escape. If you open the cooking cabinet door during automatic cleaning, a warning signal will sound.
- Make sure the core temperature probe is not hanging out of the cooking system while automatic cleaning is in progress. This could damage the seal on the cooking cabinet door and allow corrosive cleaning chemicals to escape.
- Do not clean the externally attached core temperature probes using automatic cleaning.

How to respond if you come into contact with cleaning chemicals:

- If you touch cleaning products when not wearing gloves or your skin otherwise comes into contact with cleaning products, rinse your skin with running water for 10 minutes.
- If you get cleaning chemicals into your eyes, rinse your eyes with running water for 15 minutes. Remove your contact lenses, if applicable.
- If you swallow cleaning chemicals, rinse your mouth out with water and drink two glasses of water immediately. Do not induce vomiting.
- Call the poison control hotline or a doctor immediately.

18.2 Cleaning modes

The **light**, **medium** and **strong** cleaning programs can be used in two different cleaning modes:



Eco mode

If you select this cleaning mode, cleaning programs [▶ 83] will clean the cooking system using less water and cleaning chemicals. but cleaning will take longer than it does in Normal mode.



Normal mode

If you select this cleaning mode, cleaning programs [▶ 83] will use more cleaning chemicals and water to clean the cooking system, but they will be shorter than in Eco mode.

18.3 Cleaning programs

The following cleaning programs are available to you:

Program	Mode	Description	Care product
light	Eco / Normal	Suitable for removing minor food residue and limescale accumulated when using the cooking system at temperatures of up to 400 °F.	<ul style="list-style-type: none"> Active Green cartridge Care cartridge
medium	Eco / Normal	Suitable for removing stains and limescale that have accumulated during cooking paths involving grilling or frying.	<ul style="list-style-type: none"> Active Green cartridge Care cartridge
Strong	Eco / Normal	Suitable for removing heavy soiling or significant limescale buildup that has occurred during cooking paths involving grilling or frying.	<ul style="list-style-type: none"> Active Green cartridge Care cartridge
fast	–	Suitable for interim cleaning, to remove heavy soiling quickly. This cleaning program does not reset the forced cleaning timer.	<ul style="list-style-type: none"> Active Green cartridge
Rinse without cleaner	–	Suitable for removing water-soluble dirt and grime. This cleaning program does not reset the forced cleaning timer.	–
Rinse	–	Suitable for removing stains containing limescale that occur during cooking paths involving baking or steaming.	<ul style="list-style-type: none"> Care cartridge

You have the option of editing existing cleaning programs individually and saving them. You can then export these and import them to other cooking systems.



TIP

If your cooking system is connected to soft water, you should set the soft water switch to "Soft water".

18.4 Cleaning, care and cleaner cartridge status

iCareSystem automatically detects your unit's cleaning and care status.

Cleaning status

- When the indicator is green, the cooking system is clean.
- A yellow indicator means that the cooking system is dirty, but you can continue using it to prepare food until you are prompted to run a cleaning program.
- A red indicator means that the cooking system is very dirty. Start a cleaning program as soon as possible - no later than the next time you are prompted to run a cleaning program.

Care status

- When the care status indicator is green, the steam generator is free of limescale.
- When the indicator is yellow, the steam generator has a small amount of limescale buildup.
- When the indicator is red, the steam generator has a great deal of limescale buildup. Start a cleaning program as soon as possible - no later than the next time you are prompted to run a cleaning program.

Cartridge overview

Cleaner cartridge status can be checked on the diagram designed for that purpose.



- The diagram shows the various slots and status information for each.
- Four full bars (see Slot 2) mean that the cartridge is full.
- Cleaner cartridges with a yellow warning indicator and one filled bar (see Slot 1) symbolize a cleaner cartridge that is only 25% full.
- Cleaner cartridges with a red warning indicator (see Slot 3) symbolize an empty cleaner cartridge.
- If the cleaner cartridge is grayed out (see Slot 4), it means that no cleaner cartridge has been inserted into that slot.
- Press this button:  to start the cartridge replacement wizard.
- Follow the instructions shown.
- After replacing the cleaner cartridges, please confirm on the display that you have inserted full cleaner cartridges.

18.5 Replace cleaner cartridge

CAUTION

Danger of chemical burns!

Wear close-fitting protective goggles and chemical-resistant gloves to protect yourself reliably when working with cleaner cartridges.



NOTE

Handling cleaner cartridges

- Cleaner cartridges should not be removed or inserted at random! Replace only empty cartridges with full ones.
- Do not use defective cleaner cartridges!
- Even outside of the cleaning process, do not replace empty cleaner cartridges until prompted to do so.
- If the cleaner cartridge has been dropped, check it for damage.

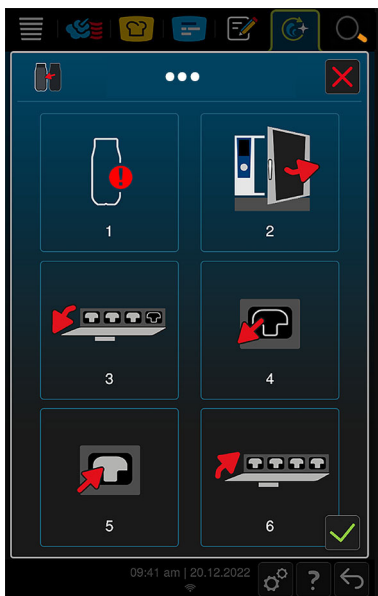
Contact your RATIONAL Service Partner if you have any questions regarding the correct handling of cleaner cartridges.



1. Press this button: .
2. Open the cooking cabinet door.
3. Open the cleaning hatch **NOTE! Do not set anything that weighs more than 7 kg atop the open cleaning hatch!** Cartridge status is displayed automatically.
4. Pull empty cartridges out of the slot via the recessed grips.
5. Unpack the Active Green cleaner cartridges or Care cleaner cartridges, remove the cap and place the cartridge into an empty slot in the chemical storage system. You can decide for yourself how many cleaner cartridges you want to use. However, we recommend using two Care cleaner cartridges and two Active Green cleaner cartridges.
6. You will be asked if you have inserted a new cleaner cartridge.
7. Close the cleaning hatch.
8. Press:  to confirm that you have inserted full cleaner cartridges.
9. Close the cooking cabinet door.

18.6 Starting automatic cleaning

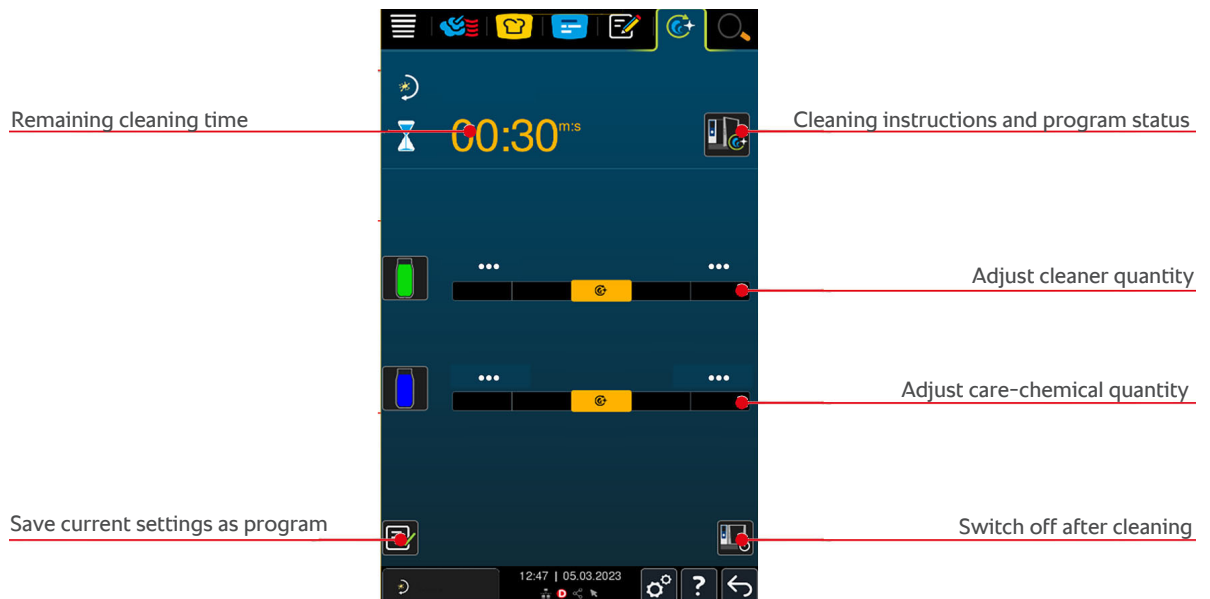

- ✓ The hinging racks are correctly placed in the cooking cabinet.
 - ✓ Make sure the mobile rack is placed correctly within the cooking cabinet. **NOTE! The locking brake must not be activated on the mobile rack.**
1. In the menu bar, press this button:
 - > If the cooking cabinet temperature is above 165 °F, this message will be displayed: **Cooking cabinet too hot**
 2. Select the desired cleaning program [▶ 83].
 3. You now have the option of adjusting cleaning chemical quantities, selecting whether the cooking system should be switched off after cleaning, and pressing the programming button.
 4. Open the cooking cabinet door.
 5. Remove any containers and trays from the cooking cabinet.
 6. Close the cooking cabinet door.
 7. The cool down function [▶ 26] will be started in order to lower the cooking cabinet temperature.
 8. Automatic cleaning will start.
 9. When automatic cleaning is finished, a signal tone will sound.
 10. Dispose of empty cartridges in the forced cleaning recycling bin.



TIPS

- If foam forms in the cooking cabinet during automatic cleaning even though you have used the recommended amount of Active Green cleaner, have your Service Partner set the foam switch (Service level). If foam continues to build up, please contact your RATIONAL Service Partner.

18.7 Canceling automatic cleaning

You can cancel all automatic cleaning programs at any time.

1. Press and hold this button:
- > You will be asked if you really want to cancel cleaning. The display will indicate how long cancellation will take.
2. Press this button:
- >> Automatic cleaning will be canceled.







TIP

If a power failure occurs during automatic cleaning, automatic cleaning will be interrupted. Once power has been established again, automatic cleaning will resume.

18.8 Forced cleaning after operating hours

If you have activated forced cleaning, you will be prompted to clean the cooking system after a specified time. You can only continue working with the cooking system once cleaning is complete.

1. Press this button: 
 2. Press this button:  **Cleaning**
 3. Press this button:  **Forced cleaning after operating hours**
 4. To activate forced cleaning, press this button: **ON**
 5. To set the time after which you want to be prompted to clean the cooking system, press this button: **Time to cleaning request** Please note that this time represents how long the cooking system has been in operation, not how much total time has passed.
 6. Set the time anywhere between 1 – 24 hours.
 7. To set the number of hours by which cleaning can be postponed following a prompt, press this button: **Forced cleaning delay time**
 8. Set the time anywhere between 1 – 24 hours.
 9. Press this button: . You can now select from either standard or custom-created **cleaning programs**.
 10. Press this button:  to switch **automatic cleaning start** on or off.
- >> The footer will indicate how many hours of operation are left until cleaning will be required.

19 Care

WARNING

Accumulated grease or food residue in the cooking cabinet

Failure to clean the cooking cabinet sufficiently could result in food residue or accumulated grease creating a fire hazard.

1. Clean the unit daily.
2. If a fire breaks out, leave the cooking cabinet door closed in order to cut off the fire's oxygen supply. Switch the unit off. If the fire has spread, use a fire extinguisher that is suitable for grease fires. Never use water or foam extinguishing agents on grease fires.

19.1 General safety information

To avoid scalding and burn injuries:

- Allow the cooking system and all functional components to cool down before cleaning.

To avoid property damage, injury or death:

- Disconnect the unit from the power supply for all cleaning work except for automatic cleaning.
- Do not spray the reservoir with the hand shower or any type of liquid.
- Clean the cooking system daily even if you are only using the Steam manual operating mode.
- Do not use the cooking system's automatic cleaning functions to clean accessories.

19.2 Care intervals

Care interval	Functional components
Daily	<ul style="list-style-type: none"> ▪ Cooking cabinet ▪ Cooking cabinet seal ▪ Cooking cabinet door ▪ Drip pan and discharge spout ▪ core temperature probe ▪ Accessories ▪ Hand shower
Weekly	<ul style="list-style-type: none"> ▪ Unit exterior surfaces ▪ LED cover ▪ Control panel ▪ Plastic parts
Monthly	<ul style="list-style-type: none"> ▪ steam nozzle

At minimum, the functional components must be cleaned in accordance with the care interval; they can be cleaned more frequently if necessary.

19.3 Care products

Suitable care products

- Clean the following functional components using lukewarm water, a mild detergent, and a soft cloth:
 - Cooking system exterior
 - Cooking cabinet door glass
 - LED cover inside cooking cabinet door
 - Cooking cabinet seal
- Clean accessories using lukewarm water, a mild detergent, and a soft cloth.

Unsuitable care products

Do not use any of the following products to clean the unit or its functional components or accessories:

- Scouring agents
- Hydrochloric acid, lye, sulphurous substances, or other oxygen-consuming agents
- Undiluted alcohol, methanol, or solutions such as acetone, benzene, toluene, or xylene
- Oven cleaner or grill cleaner
- Pot scrubber with steel wool
- Steel wool
- High-pressure cleaning jets
- Sharp or pointed tools

19.4 Cleaning the cooking cabinet door

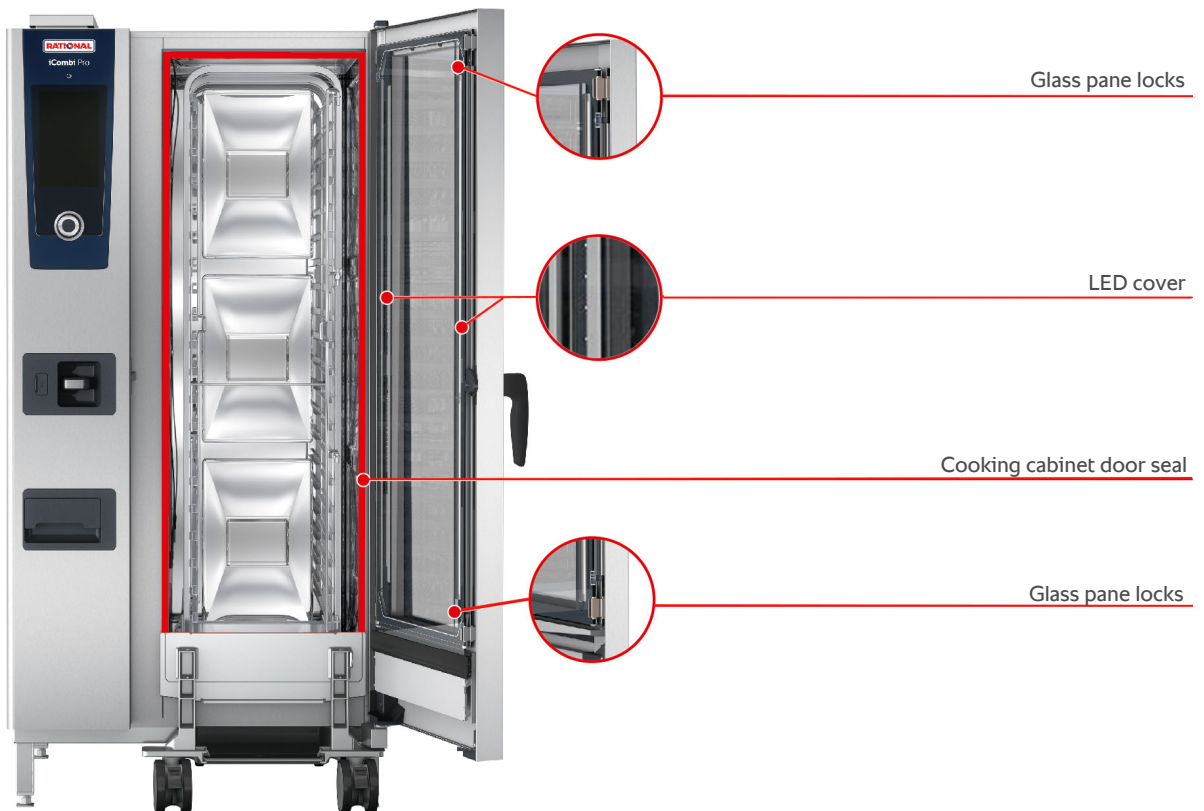

Cleaning the glass panes

1. Open the cooking cabinet door all the way, until it reaches the stop position.
2. Use light pressure to release the locks on the glass panes.
3. Swing the glass panes on the cooking cabinet door open one at a time.
4. Clean the glass panels of the cooking cabinet door with lukewarm water, a mild detergent and a soft cloth.
5. Allow the glass to dry completely.



Cleaning the LED covers

After cleaning the glass on the cooking cabinet door, you can also clean the LED covers. Use only appropriate care products [► 93] to clean the LED covers.

The LED cover is between the front and center panes of glass on the cooking cabinet door.

- ✓ Make sure the glass panes on the cooking cabinet door are unlocked.
1. Clean the LED covers with lukewarm water, a mild detergent and a soft cloth.
 2. Remove cleaning agent residues with clean water and a soft cloth.

3. Allow the LED covers to dry completely.
4. Lock all the panes back into position on the cooking cabinet door.

Cleaning the cooking cabinet door gasket

Using your cooking system in continuous operation, frequently cooking at high temperatures (above 500 °F), and cooking primarily products containing high levels of fat and gelatin can all accelerate wear on the cooking cabinet door gasket. Daily cleaning can help extend the life of the cooking cabinet door gasket.

- ✓ Start by opening the cooking cabinet door.
1. Clean the cooking cabinet door gasket with lukewarm water, a mild detergent and a soft cloth.
 2. Allow the cooking cabinet door gasket to dry completely.

Cleaning the door drip pan

Using your cooking system in continuous operation, frequently cooking at high temperatures (above 500°F), and cooking primarily products containing high levels of fat and gelatin can all result in the door drip pan becoming very dirty. Clean it daily to ensure that hygiene standards are maintained.

- ✓ Start by opening the cooking cabinet door.
1. Clean the door drip pan with lukewarm water, a mild detergent and a soft cloth.
 2. Make sure that you have removed cooking residues, accumulated grease, and crusted-on grime.

Cleaning the outlet on the door drip pan and the flat gasket on the drain opener

- ✓ Start by opening the cooking cabinet door.
1. Open the drain opener with one hand on the actuating foot and hold it securely.
 2. Clean the flat gasket and outlet with a soft cloth, lukewarm water and mild detergent to remove any grease or crusted-on food residues. Hold the steam generator drain opener securely in the open position to prevent unintentional unhooking of the mechanism.
 3. If the gasket has slipped during cleaning, return it to the correct position.

19.5 Descaling the steam nozzle



Required tool

- Hexagon key
1. Switch the unit off.
 2. Loosen the nut of the steaming nozzle with the hexagon key (A).
 3. Remove the steaming nozzle.
 4. **⚠ WARNING! Danger of chemical burns! Wear a mask and chemical protective gloves for reliable protection when handling descaler.** Place the steaming nozzle in descaler (B).
 5. Leave the steaming nozzle in the descaler until the scale is dissolved.
 6. Remove the descaled steaming nozzle from the descaler.
 7. Rinse the steaming nozzle thoroughly with water and then leave it to dry completely.
 8. Reassemble the steaming nozzle in reverse order.

19.6 Cleaning the air filter

NOTE

Spraying water may penetrate into the unit if the air filter is not inserted correctly

Correct attachment of the air filter is the only way of protecting the unit from water spraying in any direction.

1. Slide the air filter into the unit so that it snaps into place.

NOTE**Do not use sharp objects**

Do not use sharp objects such as knives to open the air filter cover, as this could damage the filter holder.

**Tools required**

- Screwdriver



1. Insert a screwdriver into the notches on the air filter cover.
2. Press the tabs in slightly.
3. Pull the air filter out.
4. Clean the air filter in the dishwasher and then allow it to dry completely.
 - > If the air filter is not clean after going through the dishwasher, it will need to be replaced.
5. Once the air filter is clean, slide it back into the cooking system.
6. Re-insert the air filter cover into the cooking system.

19.7 Cleaning the hand shower

1. Pull the hand shower hose all the way out and hold it in place.
2. Use a soft sponge to clean the hand shower and the hose.
3. To remove stubborn scale deposits, clean the hand shower and the hose using diluted vinegar.

19.8 Cleaning the control panel







⚠ CAUTION! Avoid cuts! The selection dial has sharp edges. Wear gloves when cleaning the selection dial and the surfaces around it.

1. Remove the selection dial by hand, without using tools. Lift straight up.
2. Clean the selection dial and the surface underneath it using a soft cloth.
3. Reattach the selection dial.

If your cooking system is equipped with a lockable control panel, the lockable control panel must be unlocked and the cover opened before cleaning the control panel.

You can lock the display before cleaning it, in order to keep from accidentally starting cooking paths, taking action or accessing functions.

1. Press and hold this button: 
 - > After a few seconds, the display lock will activate and this symbol will be shown: 
2. Clean the display using a soft cloth.
3. To unlock the display, press and hold this button: 
 - > The display will show this symbol: 
4. Remove the selection dial by hand, without using tools. Lift straight up.
5. Clean the selection dial and the surface underneath it using a soft cloth.
6. Reattach the selection dial.

19.9 Cleaning accessories

NOTE

Do not leave accessories in the cooking system during automatic cleaning.

Never leave accessories in the cooking system during automatic cleaning. This can damage the cooking system or the accessories.

1. Allow accessories to cool before cleaning them.
2. Use a soft cloth to remove any traces of food and grease, starch or protein residues.

3. If the stains do not come out easily, soak the accessory in lukewarm water and then use a soft cloth to wipe them clean.

19.10 Cleaning the drain ventilation pipe

If your cooking system was connected to a pre-existing siphon at the time of installation, a ventilation pipe was installed on the drain. If your water is soft or the cooking system is connected to a water softening system, and if you frequently use **medium** and **strong** cleaning programs, the foam generated during cleaning will be drained into the ventilation pipe. Clean the ventilation pipe once per week in order to ensure that foam can drain properly.

1. Pour warm water into the ventilation pipe until it is clean and free of residue. Use water at a temperature of 60°C.

20 Care - iCareSystem AutoDose

WARNING

Accumulated grease or food residue in the cooking cabinet

Failure to clean the cooking cabinet sufficiently could result in food residue or accumulated grease creating a fire hazard.

1. Clean the unit daily.
2. If a fire breaks out, leave the cooking cabinet door closed in order to cut off the fire's oxygen supply. Switch the unit off. If the fire has spread, use a fire extinguisher that is suitable for grease fires. Never use water or foam extinguishing agents on grease fires.

20.1 General safety information

To avoid scalding and burn injuries:

- Allow the cooking system and all functional components to cool down before cleaning.

To avoid property damage, injury or death:

- Disconnect the unit from the power supply for all cleaning work except for automatic cleaning.
- Do not spray the reservoir with the hand shower or any type of liquid.
- Clean the cooking system daily even if you are only using the Steam manual operating mode.
- Do not use the cooking system's automatic cleaning functions to clean accessories.

20.2 Care products

Suitable care products

- Clean the following functional components using lukewarm water, a mild detergent, and a soft cloth:
 - Cooking system exterior
 - Cooking cabinet door glass
 - LED cover inside cooking cabinet door
 - Cooking cabinet seal
- Clean accessories using lukewarm water, a mild detergent, and a soft cloth.

Unsuitable care products

Do not use any of the following products to clean the unit or its functional components or accessories:

- Scouring agents
- Hydrochloric acid, lye, sulphurous substances, or other oxygen-consuming agents
- Undiluted alcohol, methanol, or solutions such as acetone, benzene, toluene, or xylene
- Oven cleaner or grill cleaner
- Pot scrubber with steel wool
- Steel wool
- High-pressure cleaning jets
- Sharp or pointed tools

20.3 Maintenance intervals for AutoDose

Care interval	Functional components
Daily	<ul style="list-style-type: none"> ▪ Cooking cabinet ▪ Cooking cabinet seal ▪ Cooking cabinet door

Care interval	Functional components
	<ul style="list-style-type: none"> ▪ Drip pan and discharge spout ▪ core temperature probe ▪ Accessories ▪ Hand shower
Weekly	<ul style="list-style-type: none"> ▪ Unit exterior surfaces ▪ LED cover ▪ Control panel ▪ Plastic parts
Monthly	<ul style="list-style-type: none"> ▪ steam nozzle ▪ Cleaning hatch

At minimum, the functional components must be cleaned in accordance with the care interval; they can be cleaned more frequently if necessary.

20.4 Cleaning the cooking cabinet door

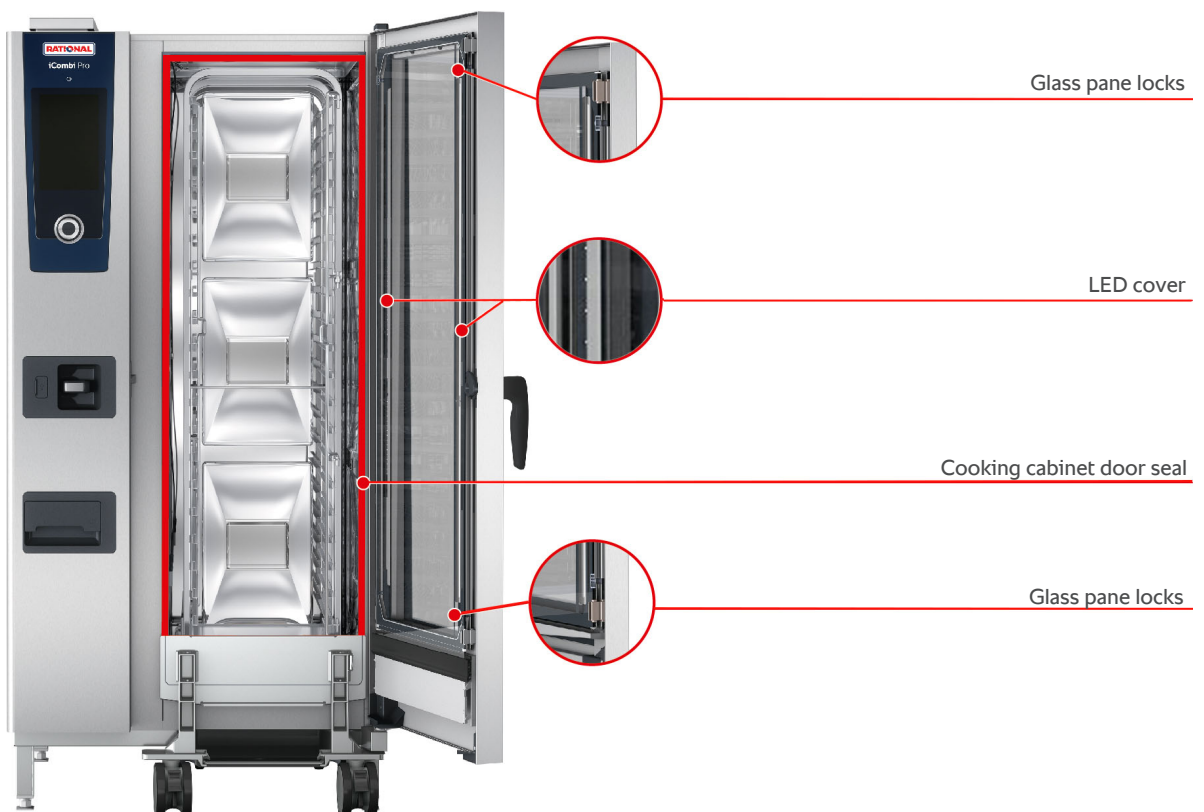

Cleaning the glass panes

1. Open the cooking cabinet door all the way, until it reaches the stop position.
2. Use light pressure to release the locks on the glass panes.
3. Swing the glass panes on the cooking cabinet door open one at a time.
4. Clean the glass panels of the cooking cabinet door with lukewarm water, a mild detergent and a soft cloth.
5. Allow the glass to dry completely.



Cleaning the LED covers

After cleaning the glass on the cooking cabinet door, you can also clean the LED covers. Use only appropriate care products [► 99] to clean the LED covers.

The LED cover is between the front and center panes of glass on the cooking cabinet door.

- ✓ Make sure the glass panes on the cooking cabinet door are unlocked.
- 1. Clean the LED covers with lukewarm water, a mild detergent and a soft cloth.
- 2. Remove cleaning agent residues with clean water and a soft cloth.
- 3. Allow the LED covers to dry completely.
- 4. Lock all the panes back into position on the cooking cabinet door.

Cleaning the cooking cabinet door gasket

Using your cooking system in continuous operation, frequently cooking at high temperatures (above 500 °F), and cooking primarily products containing high levels of fat and gelatin can all accelerate wear on the cooking cabinet door gasket. Daily cleaning can help extend the life of the cooking cabinet door gasket.

- ✓ Start by opening the cooking cabinet door.
- 1. Clean the cooking cabinet door gasket with lukewarm water, a mild detergent and a soft cloth.
- 2. Allow the cooking cabinet door gasket to dry completely.

Cleaning the door drip pan

Using your cooking system in continuous operation, frequently cooking at high temperatures (above 500°F), and cooking primarily products containing high levels of fat and gelatin can all result in the door drip pan becoming very dirty. Clean it daily to ensure that hygiene standards are maintained.

- ✓ Start by opening the cooking cabinet door.
- 1. Clean the door drip pan with lukewarm water, a mild detergent and a soft cloth.
- 2. Make sure that you have removed cooking residues, accumulated grease, and crusted-on grime.

Cleaning the outlet on the door drip pan and the flat gasket on the drain opener

- ✓ Start by opening the cooking cabinet door.
- 1. Open the drain opener with one hand on the actuating foot and hold it securely.
- 2. Clean the flat gasket and outlet with a soft cloth, lukewarm water and mild detergent to remove any grease or crusted-on food residues. Hold the steam generator drain opener securely in the open position to prevent unintentional unhooking of the mechanism.
- 3. If the gasket has slipped during cleaning, return it to the correct position.

20.5 Descaling the steam nozzle



Required tool

- Hexagon key
- 1. Switch the unit off.
- 2. Loosen the nut of the steaming nozzle with the hexagon key (A).
- 3. Remove the steaming nozzle.
- 4. **⚠ WARNING! Danger of chemical burns! Wear a mask and chemical protective gloves for reliable protection when handling descaler.** Place the steaming nozzle in descaler (B).
- 5. Leave the steaming nozzle in the descaler until the scale is dissolved.
- 6. Remove the descaled steaming nozzle from the descaler.
- 7. Rinse the steaming nozzle thoroughly with water and then leave it to dry completely.
- 8. Reassemble the steaming nozzle in reverse order.

20.6 Cleaning the air filter

NOTE

Spraying water may penetrate into the unit if the air filter is not inserted correctly

Correct attachment of the air filter is the only way of protecting the unit from water spraying in any direction.

1. Slide the air filter into the unit so that it snaps into place.

NOTE

Do not use sharp objects

Do not use sharp objects such as knives to open the air filter cover, as this could damage the filter holder.



Tools required

- Screwdriver



1. Insert a screwdriver into the notches on the air filter cover.
2. Press the tabs in slightly.
3. Pull the air filter out.
4. Clean the air filter in the dishwasher and then allow it to dry completely.
 - > If the air filter is not clean after going through the dishwasher, it will need to be replaced.
5. Once the air filter is clean, slide it back into the cooking system.
6. Re-insert the air filter cover into the cooking system.

20.7 Cleaning the hand shower

1. Pull the hand shower hose all the way out and hold it in place.
2. Use a soft sponge to clean the hand shower and the hose.
3. To remove stubborn scale deposits, clean the hand shower and the hose using diluted vinegar.

20.8 Cleaning the control panel







⚠ CAUTION! Avoid cuts! The selection dial has sharp edges. Wear gloves when cleaning the selection dial and the surfaces around it.

1. Remove the selection dial by hand, without using tools. Lift straight up.
2. Clean the selection dial and the surface underneath it using a soft cloth.
3. Reattach the selection dial.

If your cooking system is equipped with a lockable control panel, the lockable control panel must be unlocked and the cover opened before cleaning the control panel.

You can lock the display before cleaning it, in order to keep from accidentally starting cooking paths, taking action or accessing functions.

1. Press and hold this button: 
 - > After a few seconds, the display lock will activate and this symbol will be shown: 
2. Clean the display using a soft cloth.
3. To unlock the display, press and hold this button: 
 - > The display will show this symbol: 
4. Remove the selection dial by hand, without using tools. Lift straight up.
5. Clean the selection dial and the surface underneath it using a soft cloth.
6. Reattach the selection dial.

20.9 Cleaning accessories

NOTE

Do not leave accessories in the cooking system during automatic cleaning.

Never leave accessories in the cooking system during automatic cleaning. This can damage the cooking system or the accessories.

1. Allow accessories to cool before cleaning them.
2. Use a soft cloth to remove any traces of food and grease, starch or protein residues.

3. If the stains do not come out easily, soak the accessory in lukewarm water and then use a soft cloth to wipe them clean.

20.10 Cleaning the drain ventilation pipe

If your cooking system was connected to a pre-existing siphon at the time of installation, a ventilation pipe was installed on the drain. If your water is soft or the cooking system is connected to a water softening system, and if you frequently use **medium** and **strong** cleaning programs, the foam generated during cleaning will be drained into the ventilation pipe. Clean the ventilation pipe once per week in order to ensure that foam can drain properly.

1. Pour warm water into the ventilation pipe until it is clean and free of residue. Use water at a temperature of 60°C.





21 Inspiration and help

21.1 search assistant

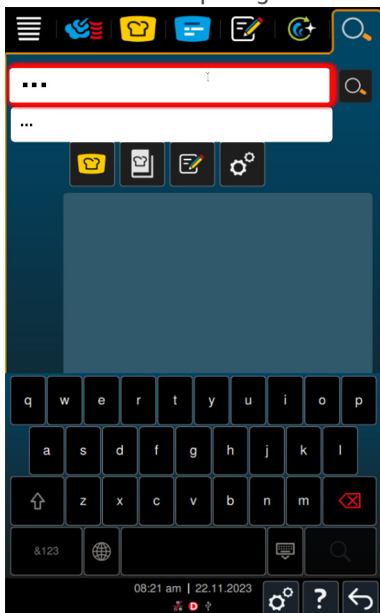
Your cooking system's search function makes it easier to search for intelligent cooking paths, custom programs, settings, and application examples.

1. In the menu bar, press this button: .
2. Enter your search term. The integrated text search ensures precise results even in the event of typos or similarities in spelling.



- > As you type, the search function will auto-suggest results in the set language. The path displayed allows you to trace the found result's location on the cooking system.
 - > The search results are divided into the categories **iCookingSuite** , **Application examples** , **Custom programs**  and **Settings** .
 - > You can filter the results by intelligent cooking paths, custom programs, settings, and application examples.
3. Tap an icon in order to display those search results.

The search function allows you to start cooking paths, custom programs, and application examples directly from a search. It also helps users see which dishes can be found in which cooking paths. In short, it is a comprehensive solution for an optimized cooking experience.

21.2 Unit help function

These operating instructions are available in the cooking system as a help function. Information about load capacities and instructions for using RATIONAL accessories are included as well.

When you press , the cooking system will always display help content corresponding to the area you are currently in.

21.3 Telephone help

ChefLine®

Whenever you have application or recipe questions, we'd be happy to provide assistance through our ChefLine. We offer quick, straightforward advice from one chef to another, 365 days a year. Just call the RATIONAL ChefLine®. You can find the number on the ChefLine® sticker on the cooking cabinet door, in the settings under Service and at rational-online.com.

RATIONAL Service Partners



Our cooking systems are reliable and built to last. Should you ever encounter technical issues, our RATIONAL Service Partners can provide fast, efficient assistance. Spare part supplies are guaranteed, and weekend emergency service is included. You can find the number under Settings > Service or at rational-online.com.

21.4 Service-related help

21.4.1 Transmitting service data to ConnectedCooking automatically

If your unit is connected to ConnectedCooking, you can set it to transmit service data to ConnectedCooking automatically at regular intervals.

✓ Start by connecting your unit to ConnectedCooking [▶ 80].

1. Press this button: 
2. Press this button:  **ConnectedCooking**
3. Next to **Transfer service data automatically**, click this button: **ON**

>> Service data will now be transferred to ConnectedCooking automatically. You can view that data in your account on connectedcooking.com or through the ConnectedCooking app.

21.4.2 Querying service data

You can call up the service data in the settings. More information is available here: Service [▶ 75]

21.5 Problem resolution

You can swipe error messages aside if they appear while you are waiting for help. The error messages will be minimized and shown on the side of the display as a red symbol. Tapping that symbol will display the error message in original size again.

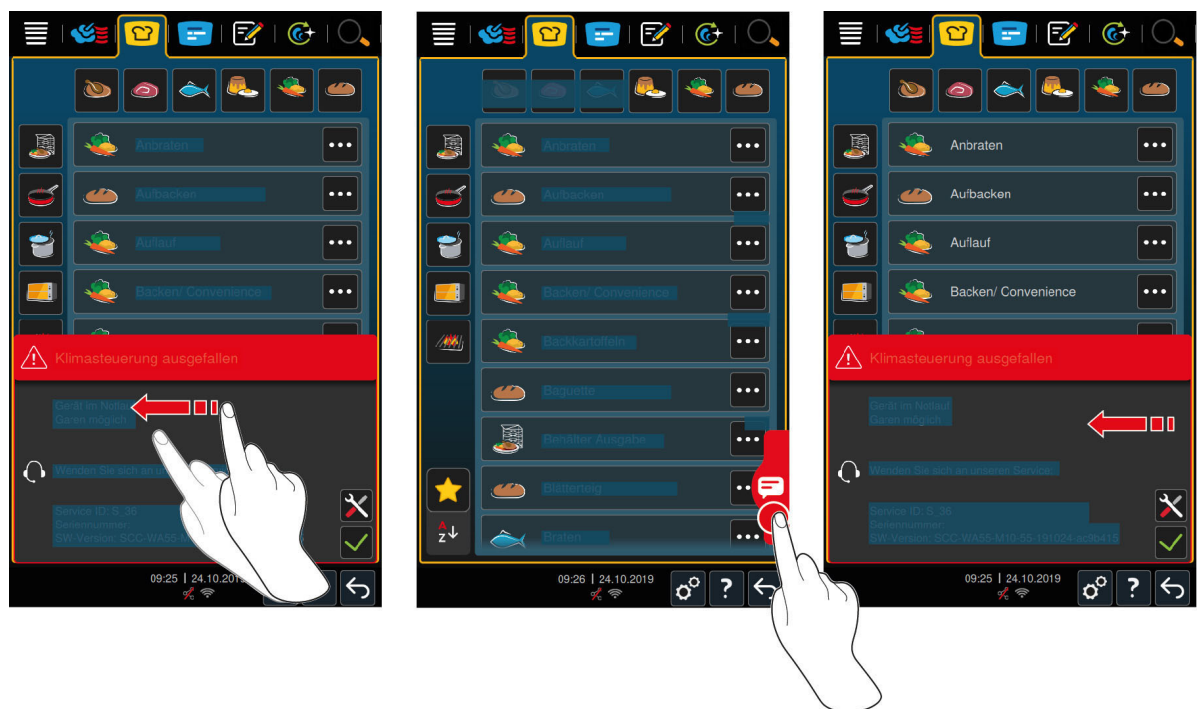

Please contact your RATIONAL Service Partner regarding all error messages. Always have your cooking system's serial number and the installed software version number at the ready. This information will be displayed in the error message.

21.5.1 Error messages heating steam generator

Error message	Cause	Cooking possible
Service 10	SC automation is malfunctioning.	Yes

Error message	Cause	Cooking possible
Service 11	The water intake for the steam generator is malfunctioning.	Yes
Service 12	The water measurement system is malfunctioning.	Yes
Service 13	Detection of the water level in the steam generator is malfunctioning.	Only hot air mode is available.
Service 20.8	Temperature probe defective.	Only hot air mode is available.
Service 28.4	Cooking cabinet temperature limit exceeded.	Only hot air mode is available.
Service 42.1	The water supply is malfunctioning.	Only hot air mode is available.
Service 43.1	The internal water supply is not closing.	Only hot air mode is available.
Service 46.1	The water supply is malfunctioning.	Yes

21.5.2 Error messages for gas units

If your unit is connected to the gas supply, the following additional error message could appear. For all error messages, please contact your RATIONAL Service Partner [▶ 105]. Always have the serial number of your unit ready.

Error report	Cause	Cooking possible
Service 32.1	The gas burner is faulty. Close the shut-off valve on the gas line.	No
Service 32.2	The gas burner is faulty. Close the shut-off valve on the gas line.	No
Service 32.3	The gas burner is faulty. Close the shut-off valve on the gas line.	No
Service 33.1	The gas burner is faulty. Close the shut-off valve on the gas line.	No
Service 33.2	The gas burner is faulty. Close the shut-off valve on the gas line.	No
Service 33.3	The gas burner is faulty. Close the shut-off valve on the gas line.	No
Service 34.32	The internal data communication is faulty.	Yes
Service 60	The initialisation of the ignition box is defective. Switch the unit off and on again. If the error is still displayed, call your Service Partner.	–

21.5.3 Error messages heating hot air

Error report	Cause	Cooking possible
Service 20.1	The temperature probe is defective.	No
Service 28.1	The temperature limit of the steam generator has been exceeded.	No
Service 28.2	The temperature limit of the cooking cabinet has been exceeded.	No
Service 34.1	The internal data communication is faulty.	No
Service 34.2	The internal data communication is faulty.	No
Service 34.4	The internal data communication is faulty.	No

Error report	Cause	Cooking possible
Service 42.3	The water supply is faulty.	The steam injection function is not available.
Service 42.6	The water supply is faulty.	Yes
Service 43.3	The internal water supply is not closing.	Only the convection mode is available at the moment.

21.5.4 Error messages humidity

Error report	Cause	Cooking possible
Service 20.2	The temperature probe is defective.	Yes
Service 20.4	The temperature probe is defective.	Yes
Service 30	The humidity measurement is incorrect.	Yes
Service 36	The differential pressure sensor is defective.	Yes
Service 37	The differential pressure sensor is defective.	Yes
Service 42.2	The water supply is faulty.	Yes
Service 43.2	The internal water supply is not closing.	Only the convection mode is available at the moment.

21.5.5 iCareSystem error messages – cleaning

Error report	Cause	Cooking possible
Service 25	The water quantity required by the iCareSystem is too low.	–
Service 26	The ball valve cannot find the open position.	No
Service 27	The ball valve cannot find the closed position.	No
Service 34.8	The automatic clean does not work.	Yes
Service 43.6	The internal water supply is not closing.	Only the convection mode is available at the moment.
Service 47.1	The waste water pump is defective.	Yes
Service 47.2	The waste water pump is defective.	Yes
Service 48.1	The circulating pump is defective.	Yes
Service 48.2	The circulating pump is defective.	Yes
Service 110	An error occurred in the SC pump during the automatic clean.	No
Service 120	An error occurred in the water level recognition during the automatic clean.	No

21.5.6 iCareSystem error messages – care

Error report	Cause	Cooking possible
Service 40	The quantity of care liquid required by the iCareSystem is too low.	Yes
Service 42.4	The water supply is faulty.	Yes
Service 43.4	The internal water supply is not closing.	Only the convection mode is available at the moment.
Service 49.1	The water supply is faulty.	Yes

Error report	Cause	Cooking possible
Service 49.2	The water supply is faulty.	Yes

21.5.7 Notification centre

Error report	Cause	Cooking possible
Service 17	The unit model is incorrect.	No
Service 29	The board temperature is too high.	No
Service 31.1	The core probe in the cooking cabinet is defective.	Yes, but you cannot use the core probe.
Service 31.2	The core probe in the cooking cabinet is defective.	Yes, but you cannot use the core probe.
Service 34.16	The internal data communication is faulty.	Yes
Service 34.64	The internal data communication is faulty.	Yes
Service 34.400	The internal data communication is faulty.	Yes
Service 41	The steam injection nozzle or the steam injection pipe has scale.	The steam injection function is not available.
Service 50	The real time clock on the CPU is not initialised. Set the date and time.	Yes
Service 51	The battery is defective.	Yes
Service 52.1	The cooking cabinet lighting is not working correctly.	Yes
Service 52.2	The cooking cabinet lighting is not working correctly.	Yes
Service 72	The activation temperature of a temperature probe has been exceeded.	No

22 Maintenance

You can replace the cooking cabinet door seal yourself. More information is available here: [Replacing the cooking cabinet door seal \[► 111\]](#)

Contact your RATIONAL Service Partner to have the following maintenance performed:

- Replacing air filters

22.1 Replacing air filters

NOTE

Do not use sharp objects

Do not use sharp objects such as knives to open the air filter cover, as this could damage the filter holder.

NOTE

Spraying water may penetrate into the unit if the air filter is not inserted correctly

Correct attachment of the air filter is the only way of protecting the unit from water spraying in any direction.

1. Slide the air filter into the unit so that it snaps into place.

NOTE

Only install dry air filters.

To avoid material damage, make sure that the new air filter is dry before replacing it.



Tools required

- Screwdriver



1. Press the tabs on the cover in slightly.
2. Lift off the cover and remove the air filter housing.
3. Replace the air filter.
4. Attach the air filter housing so that it clicks into place.
5. Replace the cover.

22.2 Replacing the cooking cabinet door seal



1. Open the cooking cabinet door.
2. Pull the cooking cabinet door gasket out from the groove and dispose of it.
3. Moisten the retaining lips of the new gasket with soapy water.
4. First press the corners of the gasket into the corners of the groove.
5. Then press the rest of the gasket into the groove.

23 Transport

23.1 Transporting the unit

⚠ WARNING

Moving the unit or the Combi-Duo with the locking brake on can damage the castors

Damaged castors can result in the unit or Combi-Duo tipping over and injuring you severely.

1. Always release the locking brake on the castors before transporting or shifting the unit or Combi-Duo.

⚠ WARNING

Moving the unit or the Combi-Duo with the locking brake on can damage the castors

Damaged castors can result in the unit or Combi-Duo tipping over and injuring you severely.

1. If the castors underneath the unit or the stand are visible and you want to point the castors in a different direction, release the locking brake before turning the castors.
2. Do not kick the castors.

⚠ CAUTION

Units may tip over when transported over thresholds or non-level surfaces

Pushing units across thresholds or along non-level surfaces can result in the unit tipping over and injuring you.

1. Exercise caution when moving units across thresholds or on non-level surfaces.

⚠ CAUTION

Units and Combi-Duos on castors can tip over when being transported or moved

If your unit or Combi-Duo is on castors or a stand with castors, failing to release the locking brake before transporting or shifting the unit or Combi-Duo can cause it to tip over and injure you.

1. Always release the locking brake on the castors before transporting or shifting the unit or Combi-Duo.
2. After transport, lock the locking brake on the castors again.

NOTE

Ask your service partner to transport your cooking system in order to guarantee proper operation.

You can move cooking systems that are on mobile stands or casters.

- ✓ The steam generator is emptied and the cleaning box is pumped out. **Both of these may only be done by a service partner.**
1. Before transporting the cooking system to a different location, you will need to disconnect it properly from all water, wastewater, and power supply lines.
 2. After moving the cooking system to its new location, make sure to reconnect it properly to power, water and wastewater lines, and activate the locking brakes on the mobile stand or the casters.



3. If you want to pull the cooking system out while cleaning the kitchen, release the locking brakes on the mobile stand or the casters,
4. and then carefully pull the cooking system forward.
5. Once you are finished cleaning the kitchen, push the cooking system carefully back into position and activate the locking brakes.

24 Decommissioning and disposal

24.1 Decommissioning

If you want to take your unit out of operation, please contact your RATIONAL Service Partner.

24.2 Disposal



Old cooking systems contain recyclable materials. Dispose of old cooking systems in an environmentally safe way, using appropriate collection systems.

25 Technical data

Please also note the technical information on the identification plate, which is to the left of the control panel.

25.1 Units with electrical connections

	Value
Weight (without packaging) Model 20-half size	lbs
Weight (without packaging) Model 20-full size	lbs
Protection class	IPX5
Ambient conditions	41 – 104 °F
Airborne sound emission	≤60 dBA
WLAN Standard	IEEE 802.11 b/g/n
Frequency and max. transmission power WLAN	2.4 GHz / 19.5 mW

25.2 Units with gas connections

	Value
Weight (without packaging) Model 20-half size	598 lb
Weight (without packaging) Model 20-full size	790 lbs
Protection class	IPX5
Ambient conditions	41 – 104 °F
WLAN Standard	IEEE 802.11 b/g/n
Frequency and max. transmission power WLAN	2.4 GHz / 19.5 mW
Airborne sound emission	≤65 dBA

25.3 Types and model names

The type designation and the model names on the identification plate are different. Please consult this table for guidance.

Type	Model name
LMxxxF	iCombi Pro 20-half size
LMxxxG	iCombi Pro 20-full size

25.4

25.5 Conformity

25.5.1 Units with electrical connections

This unit conforms to the following EU directives:

- Directive 2014/53/EU on the harmonisation of the laws of the Member States relating to the making available on the market of radio equipment
- Directive 2006/42/EU on machinery
- Directive 2014/30/EU on the harmonisation of the laws of the Member States relating to electromagnetic compatibility
- Directive 2011/65/EU on the restriction of the use of certain hazardous substances in electrical and electronic equipment, including 2015/863/EU

This unit conforms to the following European standards:

- EN 60335-1:2012 + A11:2014 + A13:2017
- EN 60335-2-42:2002 + A1:2008 + A11:2012

- EN 61000-3-2:2014; EN 61000-3-3:2013
- EN 55014-1:2006+A1:2009+A2:2011; EN55014-2:2015
- EN 62233:2008
- EN 1717:2000

This unit complies with the following directives for the USA and Canada:

- UL 197 - Standard for Commercial Electric Cooking Appliances
- CSA C22.2 No. 109 – Commercial Cooking Appliances

25.5.2 Units with gas connections

This unit conforms to the following EU directives:

- Regulation (EU) 2016/426 on appliances burning gaseous fuels
- Directive 2014/53/EU on the harmonisation of the laws of the Member States relating to the making available on the market of radio equipment
- Directive 2006/42/EU on machinery
- Directive 2014/30/EU on the harmonisation of the laws of the Member States relating to electromagnetic compatibility
- Directive 2011/65/EU on the restriction of the use of certain hazardous substances in electrical and electronic equipment, including 2015/863/EU

This unit conforms to the following European standards:

- EN 60335-1:2012 + A11:2014 + A13:2017
- EN 60335-2-42:2002 + A1:2008 + A11:2012
- EN 60335-2-102:2016
- EN 61000-3-2:2014; EN 61000-3-3:2013
- EN 55014-1:2006+A1:2009+A2:2011; EN55014-2:2015
- EN 62233:2008
- EN 203-1:2014; EN203-2-2:2006; EN 203-3-:2009
- EN 1672-1:2014
- EN 1717:2000

This unit complies with the following directives for the USA and Canada:

- UL 197 - Standard for Commercial Electric Cooking Appliances
- CSA C22.2 No. 109 – Commercial Cooking Appliances

26 Regulatory Information

Canada

This device complies with Industry Canada license-exempt RSS standard(s). Operation is subject to the following two conditions:

- (1) this device may not cause interference, and
- (2) this device must accept any interference, including interference that may cause undesired operation of the device.

IC: 25504-LM21

Le présent appareil est conforme aux CNR d'Industrie Canada applicables aux appareils radio exempts de licence. L'exploitation est autorisée aux deux conditions suivantes:

- (1) l'appareil ne doit pas produire de brouillage, et
- (2) l'utilisateur de l'appareil doit accepter tout brouillage radioélectrique subi, même si le brouillage est susceptible d'en compromettre le fonctionnement.

IC: 25504-LM21

USA

This device complies with part 15 of the FCC Rules. Operation is subject to the following two conditions:

- (1) This device may not cause harmful interference, and
- (2) this device must accept any interference received, including interference that may cause undesired operation.

This equipment has been tested and found to comply with the limits for a Class A digital device, pursuant to part 15 of the FCC Rules. These limits are designed to provide reasonable protection against harmful interference when the equipment is operated in a commercial environment. This equipment generates, uses, and can radiate radio frequency energy and, if not installed and used in accordance with the instruction manual, may cause harmful interference to radio communications. Operation of this equipment in a residential area is likely to cause harmful interference in which case the user will be required to correct the interference at his own expense.

FCC ID: 2AUI6Y-LM21

USA

Precautions To Be Observed Before And During Servicing To Avoid Possible Exposure To Excessive Microwave Energy

- (a) Do not operate or allow the oven to be operated with the door open.
- (b) Make the following safety checks on all ovens to be serviced before activating the magnetron or other microwave source, and make repairs as necessary: (1) Interlock operation, (2) proper door closing, (3) seal and sealing surfaces (arcing, wear, and other damage), (4) damage to or loosening of hinges and latches, (5) evidence of dropping or abuse.
- (c) Before turning on microwave power for any service test or inspection within the microwave generating compartments, check the magnetron, wave guide or transmission line, and cavity for proper alignment, integrity, and connections.
- (d) Any defective or misadjusted components in the interlock, monitor, door seal, and microwave generation and transmission systems shall be repaired, replaced, or adjusted by procedures described in this manual before the oven is released to the owner.
- (e) A Microwave leakage check to verify compliance with the Federal performance standard should be performed on each oven prior to release to the owner.

PTFEs

This product contains PTFE.

For more information about (PFAS-) chemicals in this product, visit: <https://rat.ag/pfas>



Directory of keywords

A

Activating/deactivating demo mode	63
Air filter	
Cleaning	96, 102
Automatic cleaning	
Cleaning programs	83, 88

B

Basic unit settings	
Exporting basic unit settings	68
Importing basic cooking system settings	68
Boiling temperature	25

C

Cancel	30
Cancel cooking path	30
Care	
Accessories	98, 104
Control panel	97, 103
Hand shower	96, 102
Selection dial	97, 103
Care products	
suitable care products	93, 99
unsuitable cleaners	94, 99
Central selection knob	17
Cleaning	
Air filter	96, 102
Cooking cabinet door	94, 100
Cooking cabinet door gasket	95, 101
LED cover	94, 100
Quick clean	83, 88
Cleaning programs	
Light	83, 88
Medium	83, 88
Strong	83, 88
Cleaning programs (rinse without cleaner)	88
Cleaning	94, 100
Cleaning the LED covers	94, 100
ConnectedCooking	
Registering a cooking system via smartphone	81
Registering a cooking system without a smartphone	80
Control panel	
cleaning	97, 103
Cooking cabinet climate	
Combi mode	28
Hot air	29
Steam	27
Cooking cabinet door	
Cleaning	94, 100
Cleaning the LED covers	94, 100
Cleaning the seal	95, 101
Cooking cabinet temperature	25
Combi mode	28
Hot air	29
Steam	27
Cooking path	

Starting an intelligent cooking path	52
Cooking system	
operation using gestures	16
Cool down function	26
Core temperature probe	
Baked goods	21
Error report	22
Fish fillets	21
Inserting core temperature probes	19
insertion	20, 21
Large pieces of meat	20
Removing	22
Small products	20
Steak	20
Vegetables	21
Whole chicken	20
Whole fish	21

D

Date	58
settings	59
descaling	
steaming nozzle	95, 101
Display	
open	58
Display brightness	
Set dimming after x min	60
settings	60

F

Fan speed	26
Favorite	
Saving settings as favorites	58
Forced cleaning	85, 92

G

Gas smell	13
Gestures	16

H

HACCP data	
Exporting HACCP data	68
HACCP data: Export period	68
Hand shower	
cleaning	96, 102
Spray modes	22
use	22
Help	
Help function	105
Selecting help in the cooking system	16

I

iProductionManager	
--------------------	--

Combination check	41	Exporting all developer logs	68
Positioning logic	41	exporting all service reports	69
		Exporting developer protocols for a time period	69
		Exporting error statistics logs	69
L		Settings	
Language		Save as favorite	58
Setting the user interface language	58	Shopping cart	
Light		programming	51
settings	60	review	52
		saving	52
		starting	53
M		Sound	
Maintenance		settings	60
Replace gasket	111	Sous-vide cooking	
Manual cooking		Areas of use	31
Combi mode	28	Cook and Chill	31
Convection	29	Room service	31
steam	27	Special diets	31
Master volume settings	60	Special accessories	105
		Steam injection	26
		steaming nozzle	
		descaling	95, 101
		Switching the cooking system off	14
		Switching the cooking system on	14
N			
National cuisine		T	
selecting a primary national cuisine	64	Temperature format	
selecting a secondary country cuisine	64	settings	59
		Time	
		Synchronizing time via ConnectedCooking	59
		Time of day	58
		settings	59
O		U	
Operating the unit		User images	
Central selection knob	17	Deleting all own images	68
		Exporting images	68
		Import images	67
		User profiles	
		Exporting profiles	67
		Importing profiles	67
P			
Performing maintenance yourself	110		
Profile			
activation	71		
Program			
Deleting all own programs	67		
Export	67		
importing	67		
intelligent program creation	49		
manual creation	47		
saving	49		
starting manual programs	52		
R			
Replace gasket	111		
Rinse	83, 88		
Cleaning programs	83		
S			
Safety instructions			
general	12		
Screen saver			
activation after x min	60		
on/off	60		
Search assistant	105		
Selection dial			
cleaning	97, 103		
Service			

RATIONAL AG

Siegfried-Meister-Straße 1

86899 Landsberg am Lech

Tel. +49 (0)8191 3270

Fax +49 (0)8191 21735

info@rational-online.com

rational-online.com