

# iCombi<sup>®</sup> Classic

Original instructions for use





# Table of contents

<b>1</b>	<b>Introduction .....</b>	<b>6</b>
1.1	Product guarantee.....	6
1.2	Target audience.....	6
1.3	Intended use.....	6
1.4	Using these instructions for use.....	6
1.4.1	Explanation of symbols.....	6
1.4.2	Explanation of pictograms.....	6
1.4.3	Explanation of warnings.....	7
1.4.4	Illustrations.....	7
1.4.5	Technical changes.....	7
<b>2</b>	<b>General safety information.....</b>	<b>8</b>
2.1	Safety information for units with gas line connections.....	9
2.2	Personal protective equipment.....	9
<b>3</b>	<b>Working with the unit .....</b>	<b>10</b>
3.1	Initial start-up.....	10
3.2	Switching the unit on and off.....	10
3.3	Interacting with the unit.....	10
3.4	Maximum load capacities.....	11
3.5	Opening and shutting the cooking cabinet door.....	11
3.6	Load unit.....	11
3.6.1	Loading the unit using the mobile oven rack or mobile plate rack.....	12
3.6.2	Loading Combi-Duos using the mobile oven rack or mobile plate rack.....	13
3.7	Inserting core temperature probes.....	15
3.8	Using the hand shower.....	17
3.9	Removing hinging racks.....	19
3.10	Integrated fat drain.....	19
<b>4</b>	<b>Sous-vide cooking.....</b>	<b>20</b>
<b>5</b>	<b>Finishing.....</b>	<b>21</b>
5.1	Cooking cabinet climate and temperature.....	21
5.2	Finishing food.....	21
<b>6</b>	<b>The iCombi Classic.....</b>	<b>23</b>
<b>7</b>	<b>Programming mode.....</b>	<b>24</b>
7.1	Starting programming mode.....	24
7.2	Preset programs.....	24
7.3	Creating a new program.....	25
7.4	Starting a program.....	27
7.5	Editing a program.....	27
7.6	Deleting a program.....	28
7.7	Sorting the program list.....	28
7.8	Uploading and downloading programs.....	29
<b>8</b>	<b>Preparing food.....</b>	<b>30</b>

8.1	Accessing modes .....	30
8.2	cooking parameter .....	30
8.3	Additional functions.....	32
8.4	Steam .....	33
8.4.1	Cooking cabinet climate and temperature range.....	33
8.4.2	Cooking with steam .....	34
8.5	Combi mode .....	34
8.5.1	Cooking cabinet climate and temperature range.....	34
8.5.2	Cooking in Combi Steam mode.....	35
8.6	Hot air .....	35
8.6.1	Cooking cabinet climate and temperature range.....	35
8.6.2	Cooking with hot air.....	36
<b>9</b>	<b>Settings .....</b>	<b>37</b>
9.1	Accessing settings .....	37
9.2	Setting the temperature unit.....	37
9.3	Set date and time.....	38
9.4	Switching the keyboard.....	39
9.5	Setting buzzer & buzzer volume.....	39
9.6	Flushing the hand shower .....	40
<b>10</b>	<b>Kitchen management .....</b>	<b>41</b>
10.1	Hygiene management.....	41
10.1.1	Recorded HACCP data.....	41
10.1.2	Download HACCP data .....	41
10.2	Connecting units to a network .....	42
10.2.1	Establish WLAN connection.....	47
10.2.2	Connecting the network cable .....	48
<b>11</b>	<b>Automatic cleaning.....</b>	<b>49</b>
11.1	General safety information.....	49
11.2	Cleaning programs.....	49
11.3	Starting automatic cleaning .....	50
11.4	Canceling automatic cleaning .....	52
<b>12</b>	<b>Care .....</b>	<b>54</b>
12.1	General safety information.....	54
12.2	Care intervals .....	54
12.3	Care products .....	54
12.4	Cleaning the cooking cabinet door.....	55
12.5	Cleaning the hand shower .....	56
12.6	Cleaning the drip pan and discharge spout.....	56
12.7	Cleaning the air filter .....	56
12.8	Cleaning accessories.....	57
12.9	Cleaning the drain ventilation pipe.....	57
<b>13</b>	<b>Inspiration and help.....</b>	<b>58</b>
13.1	Telephone help.....	58

13.2	Querying unit data .....	58
13.3	Problem resolution .....	58
13.3.1	Error messages heating steam generator .....	59
13.3.2	Error messages for gas units.....	59
13.3.3	Error messages heating hot air .....	60
13.3.4	Error messages humidity .....	60
13.3.5	Error messages CleanJet.....	61
13.3.6	Error messages Care .....	61
13.3.7	Info messages.....	61
13.3.8	Notification centre .....	62
13.3.9	Error messages when operating the UltraVent.....	63
<b>14</b>	<b>Maintenance.....</b>	<b>64</b>
14.1	Replacing air filters.....	64
14.2	Replacing the cooking cabinet door seal .....	65
<b>15</b>	<b>Transport .....</b>	<b>66</b>
15.1	Emptying the steam generator.....	66
15.2	Transporting the unit.....	66
<b>16</b>	<b>Decommissioning and disposal.....</b>	<b>68</b>
16.1	Decommissioning.....	68
16.2	Disposal .....	68
<b>17</b>	<b>Technical data .....</b>	<b>69</b>
17.1	Units with electrical connections.....	69
17.2	Units with gas connections.....	69
17.3	Sizes and model names.....	69
17.4	Conformity .....	69
17.4.1	Units with electrical connections.....	69
17.4.2	Units with gas connections .....	70
<b>18</b>	<b>Regulatory Information.....</b>	<b>71</b>
	<b>Directory of keywords.....</b>	<b>72</b>

# 1 Introduction

Dear customer,

Congratulations on purchasing your new iCombi Classic. Read the operating instructions carefully prior to using your unit for the first time. The operating instructions are there to ensure that you use the unit safely. Keep these operating instructions in a place that is accessible at all times to anyone who will be using the unit.

You will achieve excellent cooking results with your iCombi Classic. Thanks to the intuitive user guidance, this is possible quickly and easily with minimal training.

We hope you enjoy using your iCombi Classic.

All the best from

RATIONAL AG

## 1.1 Product guarantee

Register your unit under [www.rational-online.com/warranty](http://www.rational-online.com/warranty) to enjoy the benefits of our 2-year warranty. This page also includes the general warranty terms and information on warranty services.

RATIONAL assumes no liability for damage occurring in connection with unauthorized technical modifications or improper use.

## 1.2 Target audience

This document is written for people working in professional kitchens and food-service operations.

The unit must not be used, cleaned, or maintained by:

- Persons with restricted physical, sensory, or mental faculties
- Persons with limited knowledge and experience
- Children

Children in the vicinity of the unit must be supervised at all times. Do not allow children to play with the unit.

## 1.3 Intended use

The iCombi Classic has been developed for the preparation of hot food.

This unit is only intended for commercial use, such as in restaurant kitchens, hospital food service operations, bakeries, or delis. Do not use this unit outdoors. This unit must not be used for continuous mass industrial food production.

All other usages of this cooking system are considered improper and dangerous. RATIONAL AG assumes no liability for consequences of improper use.

## 1.4 Using these instructions for use

### 1.4.1 Explanation of symbols

This document uses the following symbols to provide information and instructions for action:

- ✓ This symbol indicates prerequisites that must be met before you take a specific action.
  1. This symbol indicates an action you will need to take.
    - > This symbol indicates an intermediate result you can use to evaluate the results of a single action.
    - >> This symbol indicates an end result you can use to evaluate the results of a series of instructions.
      - This symbol is used for bullet points.
      - a. This symbol is used in lists.

### 1.4.2 Explanation of pictograms

The following pictograms are used in this document:

 Caution! Read the instructions for use before using the unit.

 General warning symbol

 Useful information to help you use your unit.

### 1.4.3 Explanation of warnings

The following warnings are used to advise you of potentially dangerous situations and how to avoid them.

#### **DANGER**

The word DANGER indicates a situation that will result in severe injuries or death.

#### **WARNING**

The word WARNING indicates a situation that could result in severe injuries or death.

#### **CAUTION**

The word CAUTION indicates a situation that could result in injuries.

#### **NOTE**

The word NOTE indicates a situation that could result in damage to the unit.

### 1.4.4 Illustrations

The illustrations in these instructions for use may deviate from the actual unit.

### 1.4.5 Technical changes

We reserve the right to make technical changes in the interest of progress.

## 2 General safety information

This unit is constructed securely, and does not pose a danger when used normally and in accordance with specifications. These instructions for use describe proper procedures for using this unit.

- This unit should only be installed by your RATIONAL Service Partner.
- All maintenance on this unit should be performed by your RATIONAL Service Partner.
- Your cooking system should be serviced at least once a year by an authorized RATIONAL service partner to ensure that it is in perfect technical condition.
- Do not modify the unit or the way your RATIONAL Service Partner has installed it.
- Do not remove the drain sieve.
- Do not use the cooking system if it is damaged in general, or if the connection cable is damaged. Damaged cooking systems are unsafe and could cause burns or other injuries.
- Do not use the unit if the glass on the cooking cabinet door is damaged. Contact your RATIONAL Service Partner and have the cooking cabinet door glass replaced.
- Never place objects on top of the device.  
Do not place hot containers or containers of hot liquids on top of the cooking system.
- Never store flammable or combustible materials near the unit.
- Only use the unit at ambient temperatures between +50 °F and +104 °F.
- Avoid placing sources of heat near the unit, such as deep fryers or grills.
- While using the unit, keep the floor around it clean and dry.
- Regular training and safety instructions for operating personnel are essential to preventing accidents or damage to the cooking system.
- This cooking system must not be used by children or persons with reduced physical, sensory or mental capabilities, or by anyone lacking proper experience and/or knowledge, unless that person is made aware of the potential dangers of the cooking system, and remains under the supervision of someone who takes responsibility for safety. When supervising, please keep in mind that surfaces and accessories may be hot. Cleaning and user maintenance must not be performed by children, even when supervised

### Safety instructions before use

- Make sure that the temperature of the unit is at least +41°F.
- Make sure that the air baffle in front of the fan is secure at the top and the bottom.
- Make sure that the cooking cabinet is free of cleaner tab residue.
- If the unit has been inactive for a longer period of time, rinse out the hand shower with at least 2 1/2 gallons of water before using the unit again.

### Safety instructions during use

- To avoid scalding and burn injuries:
  - Exercise caution when opening the cooking cabinet door - Hot steam may escape.
  - Always wear personal protective equipment when removing anything from the hot cooking cabinet.
  - When the unit is in use, only touch the control panel and the cooking cabinet door grip. The external surfaces can heat up to temperatures exceeding 140°F.
  - Only slide containers of food into racks at levels you can see into. Otherwise, hot food can spill out when being unloaded from the unit.
- To avoid the risk of fire or explosion:
  - Do not use the cooking system to cook highly flammable liquids, e.g., wine or other alcoholic beverages. Flammable liquids can catch fire when evaporating.
  - When roasting or grilling, place a drip pan underneath the food to catch grease.
- To prevent equipment damage due to improper use of accessories:
  - Only use original RATIONAL accessories.

- If there is food in the cooking cabinet that has already been brought up to serving temperature, do not load cold food into the cooking cabinet.

To avoid injury when working with transport trolleys, mobile racks, or mobile plate racks:

- Exercise caution when pushing transport trolleys, mobile racks, or mobile plate racks across uneven surfaces or thresholds, to prevent them from tipping.
- Activate locking brakes on transport trolleys, mobile racks, or mobile plate racks to keep them from rolling away on uneven floors.
- Before sliding a mobile rack or mobile plate rack into or out of the cooking system, secure the transport trolley to your cooking system.
- When moving the mobile rack, secure the container lock on the mobile rack and cover containers of hot food. Otherwise, hot food could splash out.

#### **Safety instructions after use**

- Clean the unit after each use.
- In order to prevent the cooking cabinet from corroding, leave the cooking cabinet door open a crack whenever the unit will not be in use for a longer period, including overnight.
- If the unit will not be in use for a longer period, cut off the building water, electric and gas lines to the unit.
- Empty the steam generator before transporting the unit, or when the unit will not be in use for a longer period.

## **2.1 Safety information for units with gas line connections**

- To prevent fire risk:
  - If your cooking system is connected to a chimney, contact your gas technician regularly to have the cooking system's exhaust line cleaned. Always observe country-specific regulations in this regard.
  - Never place objects atop the exhaust pipes.
  - Keep the appliance area free and clear from combustibles
  - Gardez la zone d'exploitation de l'appareil libre et dégagée de tout combustible.
- To prevent fatal accidents:
  - If using your cooking system with a recirculating hood, always switch on the recirculating hood while the cooking system is in use. Otherwise, flammable gases could build up.
- How to respond if you smell gas:
  - Do not switch any lights or equipment on or off. Do not unplug anything. Do not use any landlines or mobile phones. They could create sparks and increase the risk of explosion.
  - Open the doors and windows to ventilate the room with fresh air. Do not switch on recirculating hoods or ventilators in order to ventilate the room. They could create sparks and increase the risk of explosion.
  - Close the shut-off mechanism of the gas line.
  - Leave the building and contact the fire department or your gas company.

## **2.2 Personal protective equipment**

- Only use the unit when wearing clothing that will protect you against work-related accidents, especially due to heat, splashing hot liquids, or corrosive substances.
- Wear gloves that will provide reliable protection when handling hot or sharp-edged objects.
- When cleaning the unit, wear tight-fitting safety glasses and chemical protective gloves that will allow you to handle cleaning products safely.

## 3 Working with the unit

### 3.1 Initial start-up

When you start your unit for the first time, it will have already been properly installed by a RATIONAL Service Partner. The self-test will have been completed, so the unit will be ready for use. Information related to installation is available in the installation manual included in delivery.

#### Before working with the unit for the first time

1. Clean the unit and all accessories before initial use.

More information is available here: Care [▶ 54]

### 3.2 Switching the unit on and off

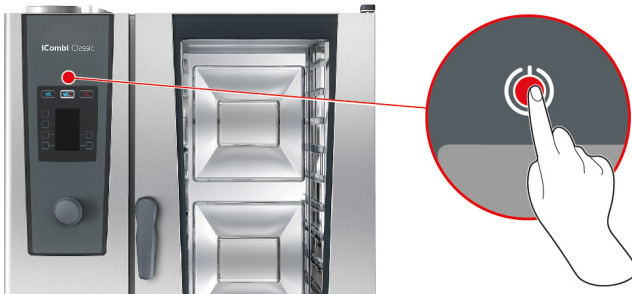

1. To switch on the device, press the button for around 3 seconds: ⏻
  - > The unit will power on. The home screen will appear.
2. To switch off the unit, press and hold the button until the status bar is shown in full at the top edge of the display: ⏻
  - >> The unit will power off.

### 3.3 Interacting with the unit

#### NOTE

#### Improper display operation

Using a sharp or pointed object to operate the display could damage the display.

1. Only operate the cooking system with your hands.

You can operate your cooking system using only the selection dial and individual gestures.



Press

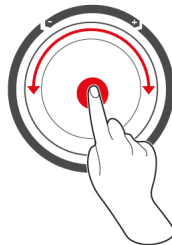

Turn and press

1. Use the control panel buttons to select operating modes or functions.
2. Turn the central dial to adjust settings.
3. Press the central dial to confirm your selection.

### 3.4 Maximum load capacities

#### NOTE

##### Damage to the unit due to overloading

Exceeding the maximum load capacity may damage the unit.

1. Never load the unit past the maximum capacity specified here.

Model	Max. load capacity [lb]	Max. load per tray
6-half size	66 lb	33 lb
6-full size	132 lb	66 lb
10-half size	99 lb	33 lb
10-full size	198 lb	66 lb

### 3.5 Opening and shutting the cooking cabinet door



Safety door lock

#### Open cooking cabinet door

1. Turn the cooking cabinet door handle to the right.
2. If your unit is equipped with a door safety lock, rotate the handle to the left first, then to the right.
3. Open the cooking cabinet door slowly. **⚠ CAUTION! Scalding hazard! When the unit is in operation, hot steam may billow out of the cooking cabinet.**

>> The fan wheel will be stopped.

#### Close cooking cabinet door

1. Press the cooking cabinet door closed firmly.

### 3.6 Load unit

#### ⚠ WARNING

##### Risk of injury due to broken glass

Always make sure that accessories are pushed all the way into the cooking system. Otherwise, the inside glass pane may break when the cooking cabinet door is closed, potentially leading to cut injuries.

**NOTE****Protruding accessories**

Always make sure that accessories are pushed all the way into the cooking system. Otherwise, the internal glass pane may break when the cooking cabinet door is closed.

1. Open the cooking cabinet door.
  - > The fan wheel brake will be activated, stopping the fan wheel.
2. Slide the food into the cooking system.
3. If grilling or roasting food, slide a container underneath the food in order to catch dripping fat. .
4. Close the cooking cabinet door. Make sure to close the cooking cabinet door all the way, and make sure that the handle is in the vertical position. **NOTE! If the cooking system has been turned off or disconnected from power for less than 15 minutes, the current process will resume where it left off.**

**Rack levels above 1.60m**

If your cooking system is installed such that the top rack level is more than 1.60m off the floor, the warning sign included in delivery must be affixed here.

**3.6.1 Loading the unit using the mobile oven rack or mobile plate rack****WARNING**

**When transporting mobile oven racks loaded with containers containing hot food, which are not covered, hot food may overflow**

Coming into contact with hot food and liquids can cause scalding injuries.

1. Cover containers filled with hot liquids or food during transport in the mobile oven rack.

**⚠ CAUTION****Transport carts and mobile oven racks can move during loading or unloading**

Failing to activate the locking brakes before loading or unloading transport carts and mobile oven racks can result in them moving and injuring you.

1. Always lock the wheels on the transport cart or mobile oven rack before loading or unloading.



1. Remove the hinging rack.
2. Place the run-in rail for the mobile oven rack on the floor of the cooking cabinet so that the 2 fixing pins are inserted in the recesses intended for them in the rear part of the cooking cabinet.
3. Press firmly on the front part of the run-in rails to anchor them within the cooking cabinet.
4. Move the transport trolley as far as it will go on the unit (A).
5. Press the lever on the transport trolley (B).
  - > The transport trolley is now locked on the run-in rail.
6. Apply the parking brakes of the transport trolley (C).
7. Slide the mobile oven rack or mobile plate rack into the cooking cabinet, to the stop position on the run-in rails.
8. Press the lever (D).
  - > This will release the locking brake on the transport cart.
9. Release the parking brakes of the transport trolley.
10. Roll the transport cart away from the unit and store it.
11. Close the cooking cabinet door. Make sure to close the cooking cabinet door completely.

### 3.6.2 Loading Combi-Duos using the mobile oven rack or mobile plate rack

**⚠ WARNING**

**When transporting mobile oven racks loaded with containers containing hot food, which are not covered, hot food may overflow**

Coming into contact with hot food and liquids can cause scalding injuries.

1. Cover containers filled with hot liquids or food during transport in the mobile oven rack.

### ⚠ CAUTION

#### Transport carts and mobile oven racks can move during loading or unloading

Failing to activate the locking brakes before loading or unloading transport carts and mobile oven racks can result in them moving and injuring you.

1. Always lock the wheels on the transport cart or mobile oven rack before loading or unloading.



1. Remove the hinging rack.
2. Place the run-in rail for the mobile oven rack on the floor of the cooking cabinet so that the 2 fixing pins are inserted in the recesses intended for them in the rear part of the cooking cabinet.
3. Press firmly on the front part of the run-in rail so that the run-in rail is fixed in the cooking cabinet.
4. Move the transport trolley as far as it will go on the unit.
5. To load the top unit of the Combi-Duo, press the lever on the transport trolley and pull the handle towards you (A).
  - > The transport trolley is now locked on the run-in rail.
6. Now push the mobile oven rack or the mobile plate rack into the cooking cabinet as far as it will go in the run-in rail.
7. Pull the lever on the right side of the mobile oven rack or mobile plate rack towards you and apply the brakes. This ensures that the mobile oven rack or mobile plate rack remains securely in the cooking cabinet.
8. Apply the parking brakes of the transport trolley.
9. Press the lever on the transport trolley back to its original position.
  - > The transport trolley lock is released.
10. To load the bottom unit of the Combi-Duo, press the lever on the transport trolley forwards and then pull the handle upwards (B).
  - > The transport trolley is now locked on the run-in rail.
11. Now push the mobile oven rack or the mobile plate rack into the cooking cabinet as far as it will go in the run-in rail.
12. Pull the lever on the right side of the mobile oven rack or mobile plate rack towards you and apply the brakes. This ensures that the mobile oven rack or mobile plate rack remains securely in the cooking cabinet.
13. Press the lever on the transport trolley back to its original position.

> The transport trolley lock is released.

14. Take the transport trolley away from the unit to its storage location.

15. Close the cooking cabinet doors. Make sure that the cooking cabinet doors are fully closed.

### 3.7 Inserting core temperature probes

This section describes how to work with the core temperature probe, as well as how to work with the optional, externally attachable core temperature probe.

#### CAUTION

##### Hot core temperature probe

Touching the hot core temperature probe without protective gloves could result in burns.

1. Always wear gloves when working with hot core temperature probes.
2. If necessary, use the hand shower to cool the core temperature probe down.

#### NOTE

##### Core temperature probe hanging out of the cooking cabinet

Failing to return the core temperature probe to its holder after use could result in damage to the core temperature probe.

1. After using the core temperature probe, return it to its holder.

#### TIP

- If you often prepare very thin or liquid food, we recommend using the optional positioning aid. Insert the core temperature probe into the positioning aid first, and then into the food.
- If the core temperature probe is hotter than the set core temperature, use the hand shower to cool the core temperature probe.



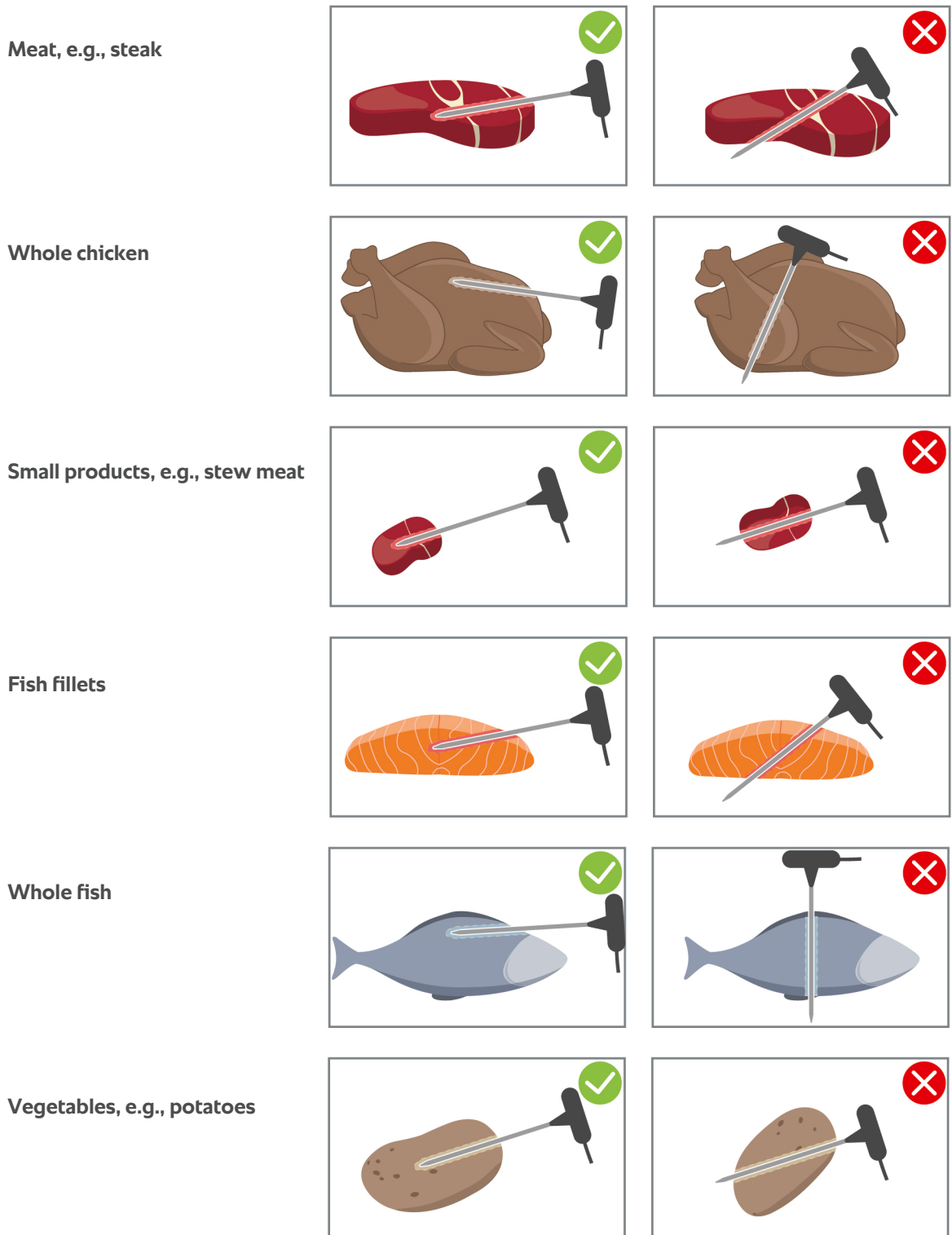

**Meat, e.g., steak**

1. Insert the core temperature probe into the food at an angle, so that the tip of the core temperature probe is in the thickest part of the product.

**Large pieces of meat, e.g., roasts**

1. Insert the core temperature probe into the food such that the tip of the core temperature probe is in the thickest part of the product.

**Whole chicken**

1. Insert the core temperature probe into the thickest part of the breast, not too close to the ribs.

Make sure that the tip of the core temperature probe is not poking through the abdominal cavity of the chicken. Do not insert the core temperature probe into the thigh.

#### **Fish fillets**

1. Insert the core temperature probe into the food at an angle, so that the tip of the core temperature probe is in the thickest part of the product.

#### **Whole fish**

1. Insert the core temperature probe into the food such that the tip of the core temperature probe is in the thickest part of the product.

Make sure that the tip of the core temperature probe is not poking through the abdominal cavity of the fish.

#### **Small products, e.g., stew meat**

1. Insert the core temperature probe such that the tip of the core temperature probe is in the thickest part of the product.

#### **Soups, sauces, desserts**

1. Place the core temperature probe into the Gastronorm container (hotel pan), so that the core temperature probe is completely immersed in the liquid.
2. When stirring the liquid, make sure that the core temperature probe remains in the Gastronorm container.

#### **Vegetables, e.g., potatoes**

1. Insert the core temperature probe into the food such that the tip of the core temperature probe is in the thickest part of the product.

#### **Baked goods**

1. When preparing baked goods that rise a great deal during baking, insert the core temperature probe vertically into the center of the product.

Use the optionally available positioning aid.

#### **Products of different sizes**

1. Start by inserting the core temperature probe into the smallest piece.
2. Once that piece has reached the desired core temperature, remove the small pieces from the core temperature probe, and take them out of the cooking cabinet.
3. After that, insert the probe into a larger piece and continue cooking.

#### **Finishing with the mobile plate rack**

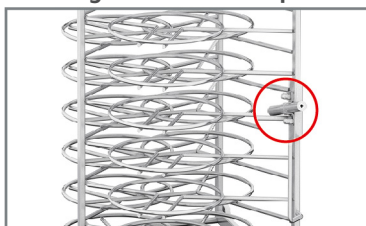



1. Insert the core temperature probe into the white ceramic tube on the mobile plate rack.

#### **Removing the core temperature probe**

1. Once the food has reached your desired degree of doneness, remove the core temperature probe from the food, and then remove the food from the cooking cabinet.
2. Once you have cleaned the core temperature probe, insert it into the holder provided and then remove the food from the cooking cabinet.

## **3.8 Using the hand shower**

Please note that you have the option of ordering a cooking system without a hand shower.

The hand shower has two spray modes: spray  (A) and jet  (B).

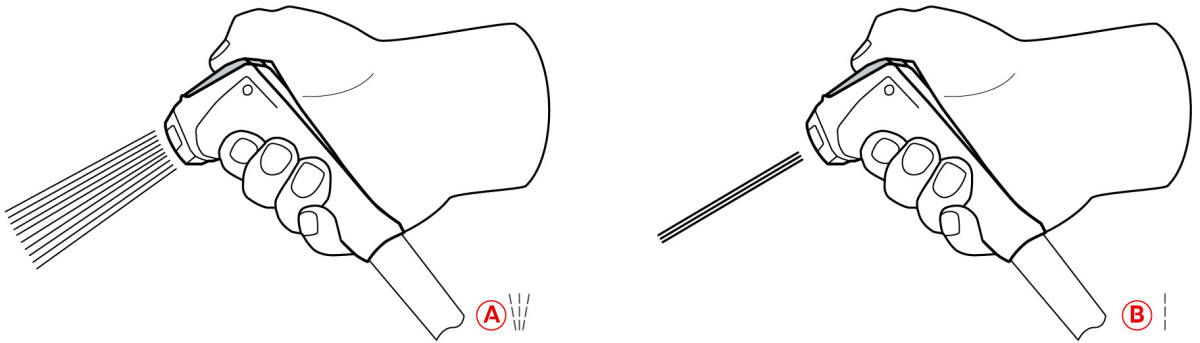

**CAUTION**

**The hand shower water and the hand shower itself may reach temperatures exceeding 140°F.**

Grasping heated parts or coming into contact with hot water may cause scalding injuries.

1. Always wear gloves when working with the hand shower.

**CAUTION**

**Water line bacterial growth**

Not using the hand shower every day can result in bacteria building up inside the water line.

1. Flush the hand shower with water for 10 seconds every morning and evening.

**NOTE**

**Improper hand shower operation**

Yanking the hand shower hose or extending it past the maximum available hose length can damage the hand shower's automatic return mechanism, after which the hand shower will no longer retract into the housing automatically.



1. Do not pull the hand shower out further than the hose length allows.

**NOTE**

**The hand shower is not suitable for cooling the cooking cabinet.**

Cooling the cooking cabinet with the hand shower could damage the cooking cabinet, the air baffle, or the glass on the cooking cabinet door.

1. Only cool the cooking cabinet using the cool-down function.

1. Pull the hand shower at least 8 in out of the park position.
2. Hold the hand shower hose firmly.
3. Turn the front part of the hand shower to select the desired spray mode.
  - Set the hand shower to  to select **jet** mode.
  - Set the hand shower to  to select the **spray** mode.

If you do not turn the front part of the hand shower to one of the two spray modes, water could drip out of the spray head.

1. Press the lever on the hand shower. The harder you press the lever, the stronger the spray will be.
2. After use, let the hand shower slowly retract into the housing. **CAUTION! Make sure that the hose of the hand shower is clean before letting it retract into the housing.**

### 3.9 Removing hinging racks

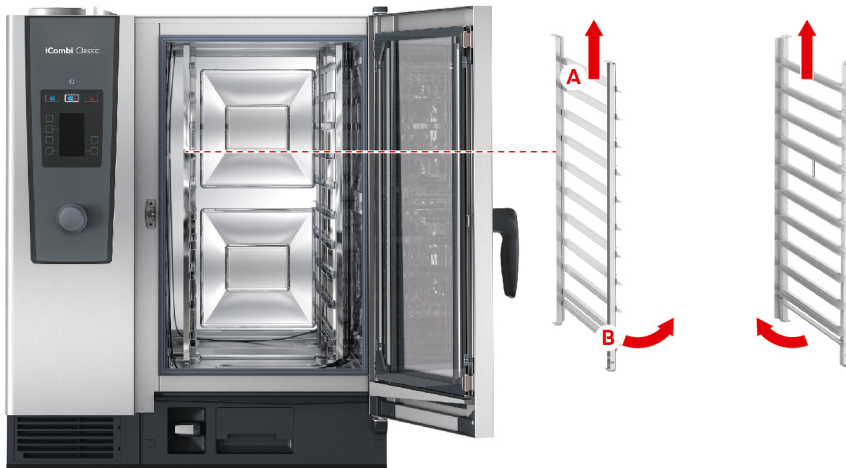

1. Hold the hinging rack in the middle of the top trays.
2. Press the hinging rack upwards (A).
3. Tilt the left hinging rack in the cooking cabinet (B).
4. Take the hinging rack off the hinges and remove it from the cooking cabinet.

### 3.10 Integrated fat drain

If your unit is equipped with an optional integrated fat drain, the dripping fat is collected in the cooking cabinet and fed into the grease drip container.

1	Ball valve handle	2	Drain pipe
3	Filler neck with bayonet lock	4	Grease drip container

1. Open the cooking cabinet door.
  2. Remove the lock of the drain pipe.
  3. Place the grease drip pan in the cooking cabinet so that the opening of the grease drip pan is in the drain pipe.
  4. Place a grease drip container (e.g. a canister) on the outside of the device under the drain.
  5. Insert the filler neck of the integrated fat drain in the grease drip container.
  6. Connect the bayonet lock of the filler neck onto the drain.
  7. Lock the bayonet lock.
  8. Turn the handle of the ball valve into the horizontal position.
- >> The ball valve is open. Dripping fat can now be collected in the grease drip container.

#### Replacing the grease drip container

#### CAUTION

**The outside of the device, the drain and the grease drip container can get very hot**

You may get burned if you touch hot functional parts. Wear personal protective equipment when replacing the grease drip container.

1. When the grease drip container is full, turn the handle of the ball valve into the vertical position.
  - > The ball valve is closed.
2. Release the bayonet lock.
3. Replace the grease drip container.
4. Dispose of the grease correctly. **NOTE! Grease and other liquid substances collected in the grease drip container must be disposed of in accordance with the legal regulations. Never dispose of grease in the drain. Never use grease collected in the grease drip container for cooking food or as a food itself.**

## 4 Sous-vide cooking

In sous-vide cooking, food is prepared, seasoned, marinated and/or seared before being placed into a vacuum bag and cooked at a low temperature. The method results in very flavorful food which retains its natural color, vitamins and minerals, and the gentle cooking process minimizes cooking losses. After cooking, the food needs to be cooled down. Before serving, the food is reheated in its plastic bag, then removed from the bag and finished accordingly.

Sous-vide cooking is particularly suitable for the following uses:

- **Cook and Chill**  
Produce your food in a central production kitchen and then deliver it to satellite kitchens. This allows you to avoid costly overproduction, because you only Finish food you actually need.
- **Room service**  
Produce dishes or individual components in advance, chill them and then Finish individual portions to order. This method allows you to offer 24-hour service whether or not an experienced cook is in the kitchen.
- **Special diets**  
This gentle cooking method preserves food's natural flavor, making it ideal for preparing low-fat, low-salt, or other special dietary options.

## 5 Finishing

Finishing allows you to separate food production and service, giving you more flexibility to spend time on important things like planning, menu design, or creative plating. Finishing minimizes loss of quality caused by long holding periods, so your food always comes out tasting great.

- You can Finish exactly as much food as you currently need, so you can respond easily to changing guest numbers.
- Shortened production and service times mean there's no more hectic rush to get everything plated.
- Reduce personnel costs by utilizing time efficiently and streamlining the process of getting food out to customers.
- Run multiple events at the same time, maximizing capacity usage without increasing expenses.

Whether you're cooking in a restaurant, a hotel, or a lunchroom, Finishing makes it even easier to serve a wide variety of great-tasting food:

- **Finishing in restaurants**  
Use Finishing to get food ready exactly when you need it.
- **Finishing in hotels**  
Plate Finishing is perfect when you need to be able to serve a large number of plates at the same time, e.g., conferences, weddings, or catering.
- **Finishing in food service operations**  
Container Finishing is especially useful when you need to provide a wide variety of food in large quantities.

You can either finish dishes manually [▶ 21] or using preset programs [▶ 24].

### 5.1 Cooking cabinet climate and temperature

Cooking cabinet climate	Cooking cabinet humidity	Cooking cabinet temperature
moist and hot	0 – 100%	Boiling temperature – 284°F



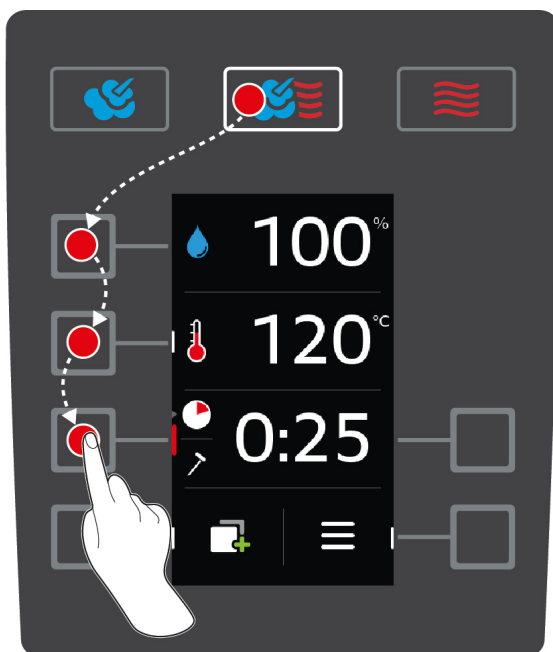

Temperatures between the boiling temperature of water and 284°F are ideal for Finishing. Within this range, food does not dry out, but moisture does not condense on the plates.

### 5.2 Finishing food

You can also finish food using pre-set programs. More information is available here: [Preset programs \[▶ 24\]](#)



1. Press this button:

2. Press this button: 
3. Turn the central selection knob to set the cooking cabinet humidity level you want.
4. Press the central selection knob to confirm your selection.
  - > The cooking parameter selector will automatically jump to **cooking temperature** .
5. Turn the central selection knob to set a cooking cabinet temperature between boiling and 140°C.
6. Press the central selection knob to confirm your selection.
  - > The cooking parameter selector will automatically jump to **cooking time** .
7. Turn the central selection knob to set the cooking time you want.
8. Press the central selection knob to confirm your selection.
9. To cook using the core temperature probe, press this button once:  Insert the core temperature probe into the white ceramic tube on the mobile plate rack.
10. Turn the central selection knob to set the core temperature you want.
11. Press the central selection knob to confirm your selection.
  - > Once the set cooking cabinet temperature has been reached, you will be prompted to load the food. Preheating will be canceled if you do not load the food within 10 minutes.
12. Load product now.
  - > The food will be Finished. Once the cooking time has elapsed or the food has reached the set core temperature, a signal tone will sound, prompting you to check whether the food has reached your desired level of doneness.

## 6 The iCombi Classic



Type 10 half size



Type 6 half size



Type 6 full size





Type 10 full size

## 7 Programming mode

Programming mode allows you to create and save your own custom cooking programs. You can save up to 100 custom programs. Each program can include up to 12 individual cooking steps. For you this means it is easy to use, no checking, no monitoring. You'll save time, reduce your energy and raw product consumption, and enjoy uniformly excellent results every single time.

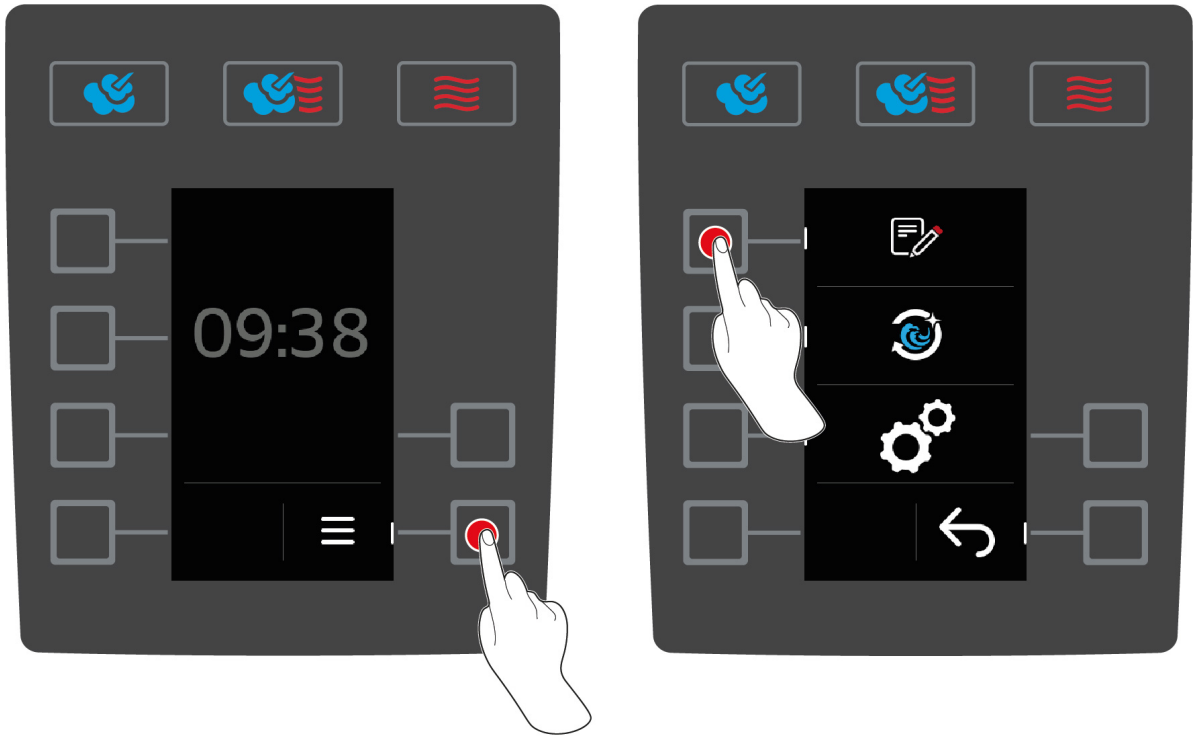
### 7.1 Starting programming mode



1. On the home screen, press this button: 
  2. Press this button: 
- >> The program list for programming mode will be displayed.

### 7.2 Preset programs

The following preset programs are available to you:

Program	Steps	Settings
Container Finishing with time	Step 1	<ul style="list-style-type: none"> <li>▪ Mode: Combi mode</li> <li>▪ Preheat: 140°C</li> </ul>
	Step 2	<ul style="list-style-type: none"> <li>▪ Cooking cabinet temperature: 140°C</li> <li>▪ Cooking cabinet humidity: 60%</li> <li>▪ Fan speed level: 4</li> <li>▪ Core temperature: 68°C</li> </ul>
	Step 3	<ul style="list-style-type: none"> <li>▪ Mode: Hot Air</li> <li>▪ Cooking cabinet temperature: 140°C</li> <li>▪ Cooking cabinet humidity: 60%</li> <li>▪ Fan speed level: 4</li> <li>▪ Cooking time: 24 minutes</li> </ul>
Container Finishing with core temperature	Step 1	<ul style="list-style-type: none"> <li>▪ Mode: Combi mode</li> <li>▪ Preheat: 140°C</li> </ul>

Program	Steps	Settings
	Step 2	<ul style="list-style-type: none"> <li>▪ Cooking cabinet temperature: 140°C</li> <li>▪ Cooking cabinet humidity: 60%</li> <li>▪ Fan speed level: 4</li> <li>▪ Core temperature: 72°C</li> </ul>
	Step 3	<ul style="list-style-type: none"> <li>▪ Mode: Hot Air</li> <li>▪ Cooking cabinet temperature: 140°C</li> <li>▪ Cooking cabinet humidity: 60%</li> <li>▪ Fan speed level: 4</li> <li>▪ Cooking time: 1 minute</li> </ul>
Plate Finishing	Step 1	<ul style="list-style-type: none"> <li>▪ Mode: Combi mode</li> <li>▪ Preheat: 130°C</li> </ul>
	Step 2	<ul style="list-style-type: none"> <li>▪ Cooking cabinet temperature: 130°C</li> <li>▪ Cooking cabinet humidity: 80%</li> <li>▪ Fan speed level: 4</li> <li>▪ Cooking time: 8 minutes</li> </ul>

More information on Finishing is available here [▶ 21](#).

### 7.3 Creating a new program

#### NOTE



##### Expand program function

When you create and save a program using a name already included in the program list, the new program will be auto-indexed when saved.

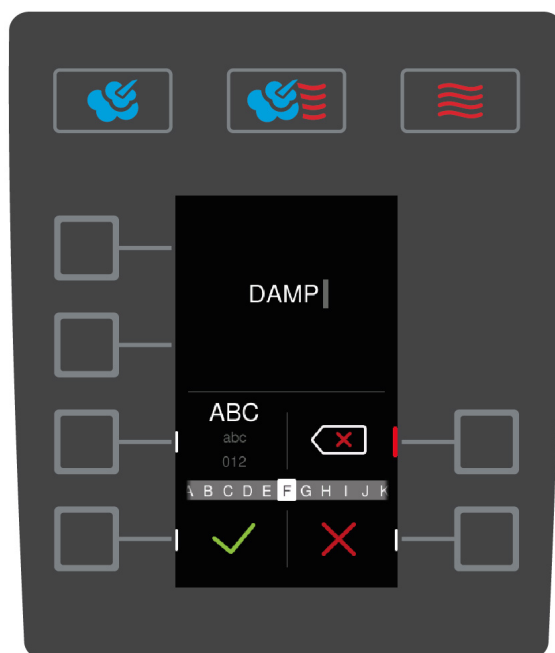
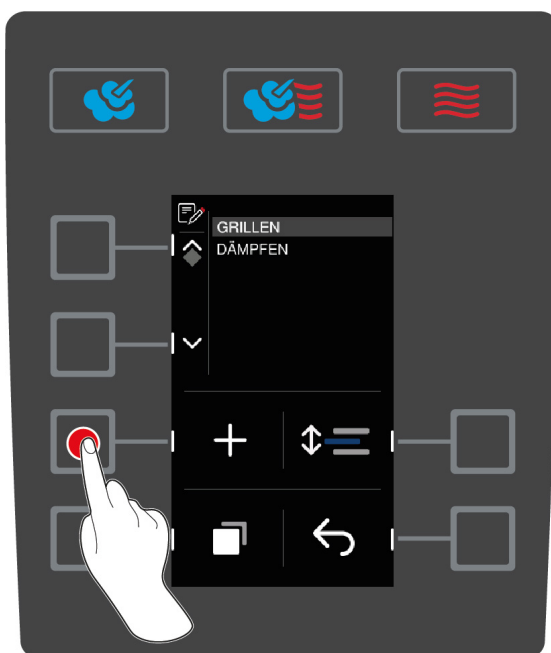
When programs with names already in the program list are uploaded to the cooking system via USB stick or ConnectedCooking, the new versions will overwrite the versions currently saved to the cooking system.



1. On the home screen, press this button:
2. Press this button:
3. Press this button:

4. Use the central dial to enter the program name. You can use any combination of upper- and lower-case letters or numbers. To switch between keyboard options, press this button: **ABC**
5. To correct your entry, press this button: 
6. Once you have finished naming your program, confirm the name by pressing this button: 
  - > The buttons for the operating modes will begin blinking.
7. Select an operating mode.
  - > The button for that operating mode will be highlighted.

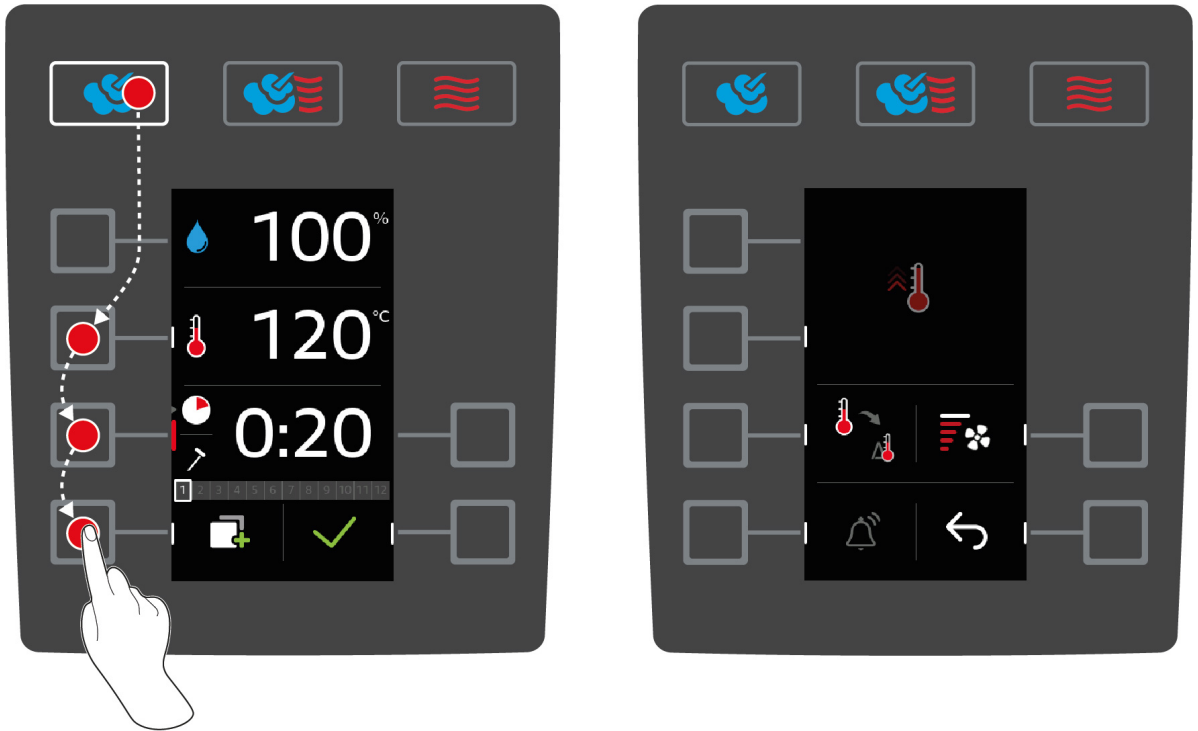





### Programming a cooking step

You can adjust various cooking parameters [► 30] depending on which cooking step you have selected. You can also select various additional functions [► 32] if applicable.

1. Press the button for the cooking parameter you want to adjust.
2. Turn the central dial to adjust settings.
3. Press the central dial to confirm your selection.
4. To confirm, press this button: 
  - > When you confirm your selection, the cooking step will be saved and displayed. You can now add up to 11 more cooking steps.

### Manual preheating

You can include preheating the cooking system as a step in your program. This will establish a heat buffer within the cooking cabinet before you load the food, ensuring that it will reach the desired temperature especially quickly even when you are preparing frozen products.

1. Press this button: 
2. Press this button: 
3. Press this button: 
4. Press this button: 
5. Turn the central dial to set the temperature you want.
6. To confirm, press this button: 
  - > Manual preheating will now be saved as the first step of the program.

7. To program another cooking step, press this button: 
  - > The buttons for the operating modes will begin blinking.
8. Choose an operating mode and finish programming the cooking step.

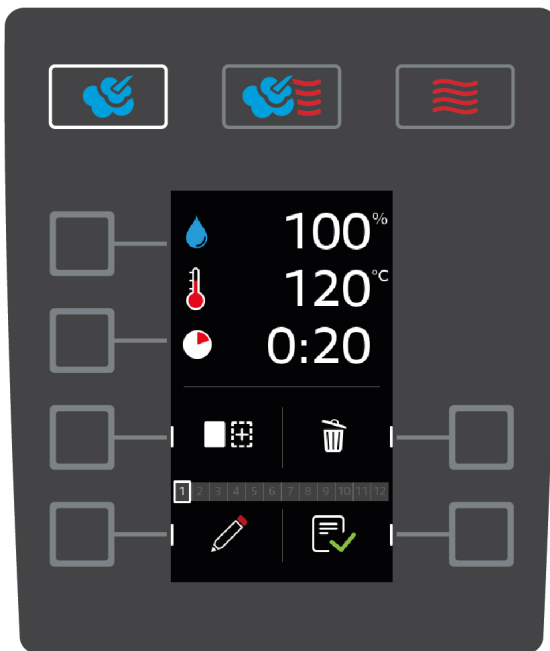

#### Adding another cooking step

1. Press this button: 
  - > The buttons for the operating modes will begin blinking.
2. Choose an operating mode and finish programming the cooking step.

#### Editing a cooking step

1. To edit the cooking step, press this button: 
2. Choose an operating mode and edit the cooking parameters as desired.



#### Deleting a cooking step

1. To delete a cooking step, press this button: 
- >> The cooking step will be deleted.



#### Saving a program







1. To save your program, press this button: 
- >> The program will be added to the bottom of the program list. You can now start the program [▶ 27].

## 7.4 Starting a program



1. Press this button: 
2. Press this button: 
3. Turn the central selection knob and choose a program.
4. Press the central selection knob to confirm your selection.
- >> The program will be started, and the unit will begin performing the first cooking step.

## 7.5 Editing a program



1. Press this button: 
2. Press this button: 

3. Turn the central selection knob and choose a program.
4. Press this button: 
5. Press this button: 
6. To rename a cooking path, make your changes and then press this button to confirm the edit: 
- > The following editing options are available:
  - Adding a cooking step 
  - Deleting a cooking step 
  - Editing cooking parameters 



#### Adding a cooking step

1. Press this button: 
- > The buttons for the operating modes will begin blinking.
2. Choose an operating mode and adjust any cooking parameters and additional functions as necessary. More information is available here: [Creating a new program \[▶ 25\]](#)
3. To save the cooking step, press this button: 
4. To save the cooking path, press this button: 



#### Deleting a cooking step

1. Turn the central selection knob to choose the cooking step you wish to delete.
2. Press this button: 
- > The cooking step will be deleted.
3. To save the cooking step, press this button: 
4. To save the cooking path, press this button: 

#### Editing cooking parameters

1. Turn the central selection knob to choose the cooking step you wish to delete.
2. Press this button: 
- > The cooking parameters for that cooking step will be displayed.
3. Choose a mode and adjust any cooking parameters and additional functions as necessary. More information is available here: [Creating a new program \[▶ 25\]](#)
4. To save the cooking step, press this button: 
5. To save the cooking path, press this button: 

## 7.6 Deleting a program

1. Press this button: 
2. Press this button: 
3. Turn the central selection knob and choose a program.
4. Press and hold the button until the status bar is shown in full: 
- >> The program will be deleted.

## 7.7 Sorting the program list

You can sort the program list to display your most frequently used programs at the top:

- ✓ Use this feature after creating programs.
1. Turn the central selection knob and choose a program.
  2. Press this button: 



3. Rotate the central selection knob until the program is in the spot you want it.
4. Press the central selection knob to confirm your selection.

## 7.8 Uploading and downloading programs

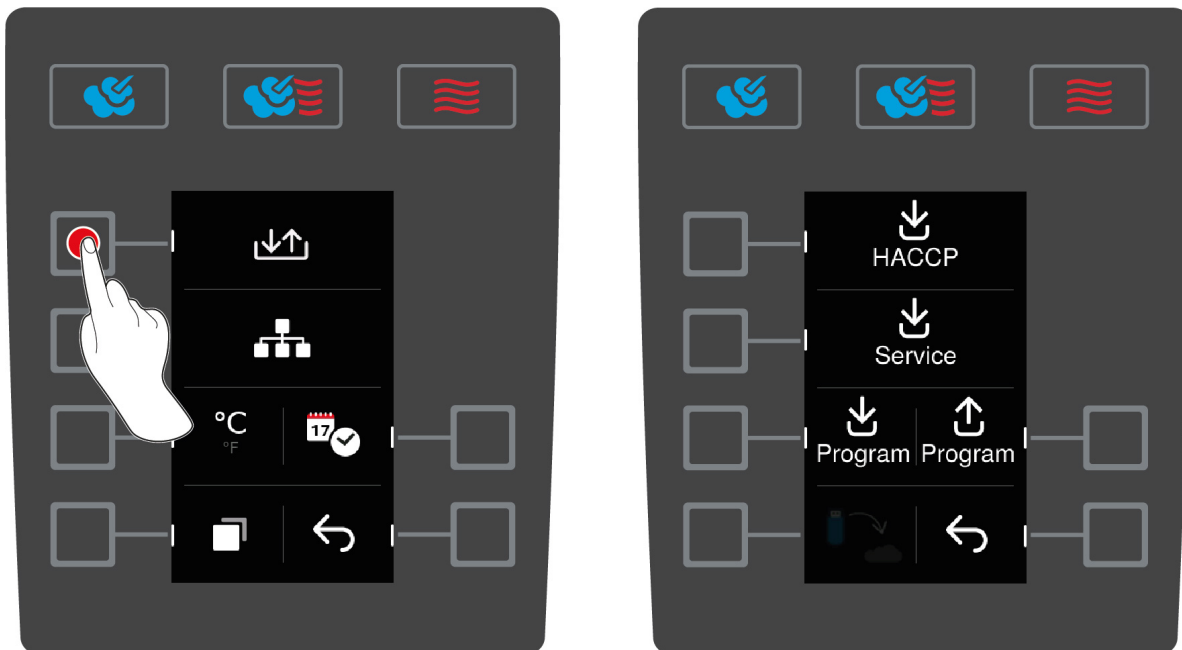

You can download programs you have created on one cooking system and transfer them to another iCombi Classic.





✓ Start by plugging a USB stick into the cooking system.

1. On the home screen, press this button: 
2. Press this button: 
3. Press this button: 

### Downloading programs

1. Press this button: 
  - > You can choose whether to download one program or all programs.
2. Turn the central dial and choose a program.
3. Press the central selection knob to confirm your selection.
4. To invert your selection, press this button: 
5. To start downloading, press this button: 
  - > Your program(s) will be downloaded.

### Uploading programs

1. Press this button: 
  - > All available programs will be displayed.
2. Turn the central dial and select your desired programs.
3. Press the central selection knob to confirm your selection.
4. To invert your selection, press this button: 
5. To start uploading, press this button: 
  - > The programs will now be uploaded.

## 8 Preparing food

### 8.1 Accessing modes

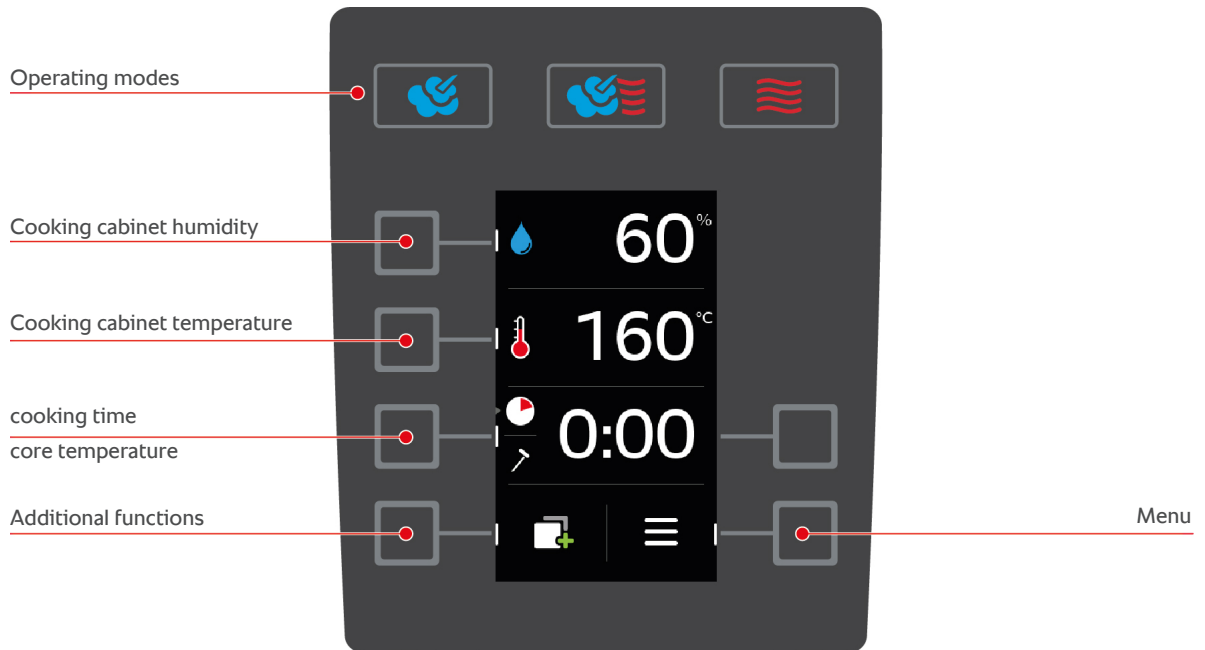

- The following operating modes are available to you:
  - Steam [► 34]
  - Combi mode [► 35]
  - Hot air [► 36]
- The following cooking parameters [► 30] are available to you:
  - Cooking cabinet humidity
  - Cooking cabinet temperature
  - Cooking time
  - core temperature
- The following additional options [► 32] are available to you:
  - Preheating
  - Cool-down function
  - Fan speed
  - Delta-T cooking

### 8.2 cooking parameter



#### Cooking cabinet humidity

Use this cooking parameter to adjust moisture levels inside the cooking cabinet.

- In **Steam** mode, the cooking cabinet humidity level is set to 100% and cannot be adjusted.
- In **Combi Steam** mode, the steam generator supplements the food's natural moisture. If the humidity exceeds the set humidity level, the cooking cabinet is dehumidified.
- In **Hot Air** mode, the steam generator does not supply additional moisture - all moisture comes from the food itself. If the humidity exceeds the set humidity level, the cooking cabinet is dehumidified.

To adjust cooking cabinet humidity:

1. Press this button: 
2. Turn the central selection knob to set the cooking cabinet humidity level you want.

3. Press the central selection knob to confirm your selection.



### Cooking cabinet temperature

Use this cooking parameter to adjust the cooking cabinet temperature.

- Whenever the heating element is activated in order to achieve the set cooking cabinet temperature, this symbol will be displayed:
- Once the cooking cabinet has reached the target temperature, this symbol will be displayed:

To adjust cooking cabinet temperature:

1. Press this button:
2. Turn the central selection knob to set the cooking cabinet temperature you want.
3. Press the central selection knob to confirm your selection.
  - > If the actual temperature is higher than the set cooking cabinet temperature, starts to flash.
4. Press this button:
5. Press this button:
- > You will be prompted to open the cooking cabinet door
  - > **⚠️ WARNING! Risk of injury! Opening the cooking cabinet door does not stop the fan. Do not touch the fan while it is in motion.** The fan speed will be increased. The cooking cabinet temperature will sink. The cooking cabinet temperature is shown in the display.
6. When the desired cooking cabinet temperature is reached, press the button:

>> The cool down function is ended.

To view the current cooking cabinet temperature and humidity level:

1. Press and hold this button:
- > After 10 seconds, the current cooking cabinet temperature will be displayed.
2. Release the button to return to the set parameters.



### Cooking time

Use this cooking parameter to set the time within which you want to achieve the specified cooking results. Alternatively, you can choose continuous mode to have your unit run uninterrupted using the settings you have chosen.

To adjust cooking time:

1. Press this button:
2. Turn the central selection knob to set the cooking time you want.
  - > If you set the cooking time to 10:00, this symbol will appear: This means that continuous mode is switched on.
3. Press the central selection knob to confirm your selection.

If you set a cooking time, the **core temperature** parameter will no longer be available.



### Core temperature

Use this cooking parameter to indicate the target core temperature or degree of doneness you want the food to have.

To adjust core temperature:

1. Press this button twice:
2. Turn the central selection knob to set the core temperature you want.
3. Press the central selection knob to confirm your selection.

When choosing core temperature settings, please observe any applicable hygiene regulations for that food in your country.

## 8.3 Additional functions



### Preheating

This additional function preheats the cooking cabinet to create a heat buffer.

This is how to set the temperature you want the unit to preheat to.

1. Press this button:
  2. Press this button:
  3. Turn the central selection knob to set the temperature you want.
  4. Press the central selection knob to confirm your selection.
    - > The unit will be heated up.
  5. To cancel the heating, press the button:
  6. To display the current cooking cabinet temperature, press and hold the button:
- >> Once heating is finished, you will be prompted to load the unit.



### Cool down function

When you finish cooking at a high temperature and want to shift to a lower cooking temperature, you can use the cool down function to cool the cooking cabinet.

✓ Make sure the air baffle is secured correctly.

1. Press this button:
  2. Press this button:
  3. **⚠ WARNING! Scalding hazard! Hot steam may billow out of the cooking cabinet when you open the cooking cabinet door.** Open the cooking cabinet door. If the cooking cabinet door is already open, close the cooking cabinet door.
    - > **⚠ WARNING! Risk of injury! Opening the cooking cabinet door does not stop the fan. Do not touch the fan while it is in motion.** The fan speed will be increased. The cooking cabinet temperature will sink. The cooking cabinet temperature is shown in the display.
  4. When the desired cooking cabinet temperature is reached, press the button:
- >> The cool down function is ended.



### Fan speed

This additional function is used to set fan speed. The higher the level, the higher the fan speed. Choose a low level for small, delicate products.

To adjust air speed:

1. Press this button:
2. Press this button:
3. Turn the central selection knob to set the air speed you want.
4. Press the central selection knob to confirm your selection.



### Delta-T cooking

#### NOTE



Please note that, when using Delta-T cooking with a cooking time, the core temperature probe must also be inserted into the product.

This additional function is used to maintain a constant differential between the cooking cabinet temperature and the core temperature. Raising the temperature of the cooking cabinet gradually, while maintaining a constant differential to the core temperature, helps cook the food slowly and gently. This option also minimizes cooking

losses. You can set the differential anywhere between 50°F and 104°F. The smaller the difference between the cooking cabinet temperature and the core temperature, the more slowly and gently the food will cook. The greater the difference between the cooking cabinet temperature and the core temperature, the quicker the food will cook.

Either a target temperature or a desired cooking time can be set. If a target core temperature is set for the product, the cooking cabinet temperature will be regulated automatically based on the difference between the set delta temperature and the set core temperature. If a cooking time is set for the product, the cooking cabinet temperature will be regulated automatically based on the difference between the set delta temperature and the end of the set cooking time.

To change delta T cooking settings:

1. Press this button: 
  2. Press this button: 
    - > The interface will automatically jump back to the cooking parameters screen. The **cooking time** cooking parameter is then replaced with the **Delta-T cooking** function. The current cooking cabinet temperature and the Delta temperature are shown.
  3. Press this button: 
  4. Turn the central selection knob to set the temperature differential you want.
  5. Press the central selection knob to confirm your selection.
    - > The interface will automatically jump to the **core temperature** cooking parameter.
  6. Turn the central selection knob to set the core temperature you want.
  7. Press the central selection knob to confirm your selection.
- >> Your cooking parameter settings will be displayed accordingly.

## 8.4 Steam

### 8.4.1 Cooking cabinet climate and temperature range

Cooking cabinet climate	cooking method	Cooking cabinet humidity	Cooking cabinet temperature
moist	<ul style="list-style-type: none"> <li>▪ Steam</li> <li>▪ Stew</li> <li>▪ Blanch</li> <li>▪ Heat through</li> <li>▪ Steaming rice</li> <li>▪ Sous-vide cooking</li> <li>▪ Defrost</li> <li>▪ Canning / Preserves</li> </ul>	100%	86 – 266°F

## 8.4.2 Cooking with steam

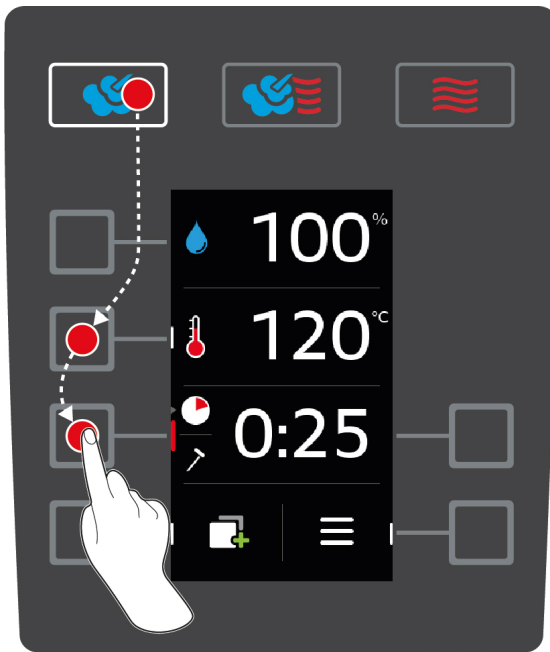

1. Press this button:
2. Press this button:
3. Turn the central selection knob to set the cooking cabinet temperature you want.
4. Press the central selection knob to confirm your selection.
  - > The cooking parameter selector will automatically jump to **cooking time**
5. Turn the central selection knob to set the cooking time you want.
6. Press the central selection knob to confirm your selection.
7. To cook using the core temperature probe, press this button once:
8. Turn the central selection knob to set the core temperature you want.
9. Press the central selection knob to confirm your selection.
  - > Once the set cooking cabinet temperature has been reached, you will be prompted to load the food. Preheating will be canceled if you do not load the food within 10 minutes.
10. Load product now.
  - > The food will be cooked. Once the cooking time has elapsed or the food has reached the set core temperature, a signal tone will sound, prompting you to check whether the food has reached your desired level of doneness.

## 8.5 Combi mode





### 8.5.1 Cooking cabinet climate and temperature range

Cooking cabinet climate	cooking method	Cooking cabinet humidity	Cooking cabinet temperature
moist and hot	<ul style="list-style-type: none"> <li>▪ Baking</li> <li>▪ Pan-fry</li> </ul>	0 – 100%	85 – 575°F

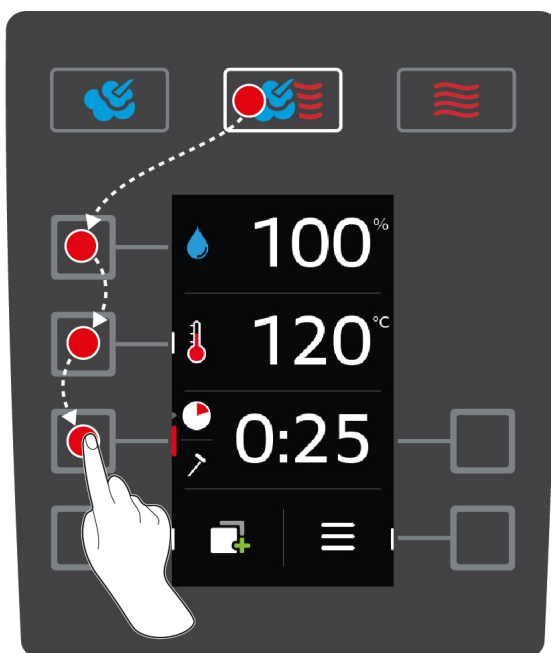
If the cooking cabinet temperature remains above 500°F for 30 minutes, it will automatically be reduced to 500°F if you do not work with the unit during that time. Taking action within those 30 minutes (opening the cooking cabinet door, for example) will reset the timer - the cooking cabinet temperature will be kept above 500°F for another 30 minutes.

## 8.5.2 Cooking in Combi Steam mode



1. Press this button: 
2. Press this button: 
3. Turn the central selection knob to set the cooking cabinet humidity level you want.
4. Press the central selection knob to confirm your selection.
  - > The cooking parameter selector will automatically jump to **cooking temperature** .
5. Turn the central selection knob to set the cooking cabinet temperature you want.
6. Press the central selection knob to confirm your selection.
  - > The cooking parameter selector will automatically jump to **cooking time** .
7. Turn the central selection knob to set the cooking time you want.
8. Press the central selection knob to confirm your selection.
9. To cook using the core temperature probe, press this button once: 
10. Turn the central selection knob to set the core temperature you want.
11. Press the central selection knob to confirm your selection.
  - > Once the set cooking cabinet temperature has been reached, you will be prompted to load the food. Preheating will be canceled if you do not load the food within 10 minutes.
12. Load product now.
  - > The food will be cooked. Once the cooking time has elapsed or the food has reached the set core temperature, a signal tone will sound, prompting you to check whether the food has reached your desired level of doneness.

## 8.6 Hot air

### 8.6.1 Cooking cabinet climate and temperature range

Cooking cabinet climate	cooking method	Cooking cabinet humidity	Cooking cabinet temperature
hot	<ul style="list-style-type: none"> <li>▪ Baking</li> <li>▪ Pan-fry</li> <li>▪ Grilling</li> <li>▪ Deep-fry</li> </ul>	0 – 100%	85 – 575°F

Cooking cabinet climate	cooking method	Cooking cabinet humidity	Cooking cabinet temperature
	<ul style="list-style-type: none"> <li>▪ Browning</li> <li>▪ Glazing</li> </ul>		

If the cooking cabinet temperature remains above 500°F for 30 minutes, it will automatically be reduced to 500°F if you do not work with the unit during that time. Taking action within those 30 minutes (opening the cooking cabinet door, for example) will reset the timer - the cooking cabinet temperature will be kept above 500°F for another 30 minutes.

## 8.6.2 Cooking with hot air

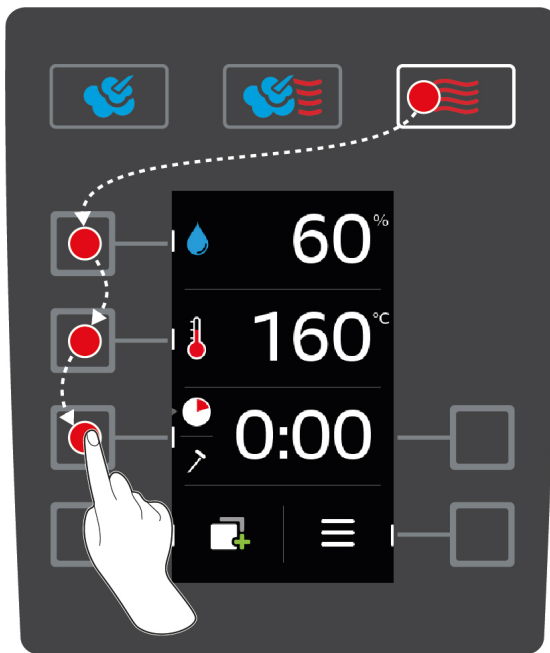

1. Press this button: ☁️
2. Press this button: 💧
3. Turn the central selection knob to set the maximum cooking cabinet humidity level you want.
4. Press the central selection knob to confirm your selection.
  - > The cooking parameter selector will automatically jump to **cooking temperature** 🌡️.
5. Press the central selection knob to confirm your selection.
  - > The cooking parameter selector will automatically jump to **cooking time** 🕒.
6. Turn the central selection knob to set the cooking time you want.
7. Press the central selection knob to confirm your selection.
8. To cook using the core temperature probe, press this button once: ➤
9. Turn the central selection knob to set the core temperature you want.
10. Press the central selection knob to confirm your selection.
  - > Once the set cooking cabinet temperature has been reached, you will be prompted to load the food. Preheating will be canceled if you do not load the food within 10 minutes.
11. Load product now.
  - > The food will be cooked. Once the cooking time has elapsed or the food has reached the set core temperature, a signal tone will sound, prompting you to check whether the food has reached your desired level of doneness.

## 9 Settings

### 9.1 Accessing settings

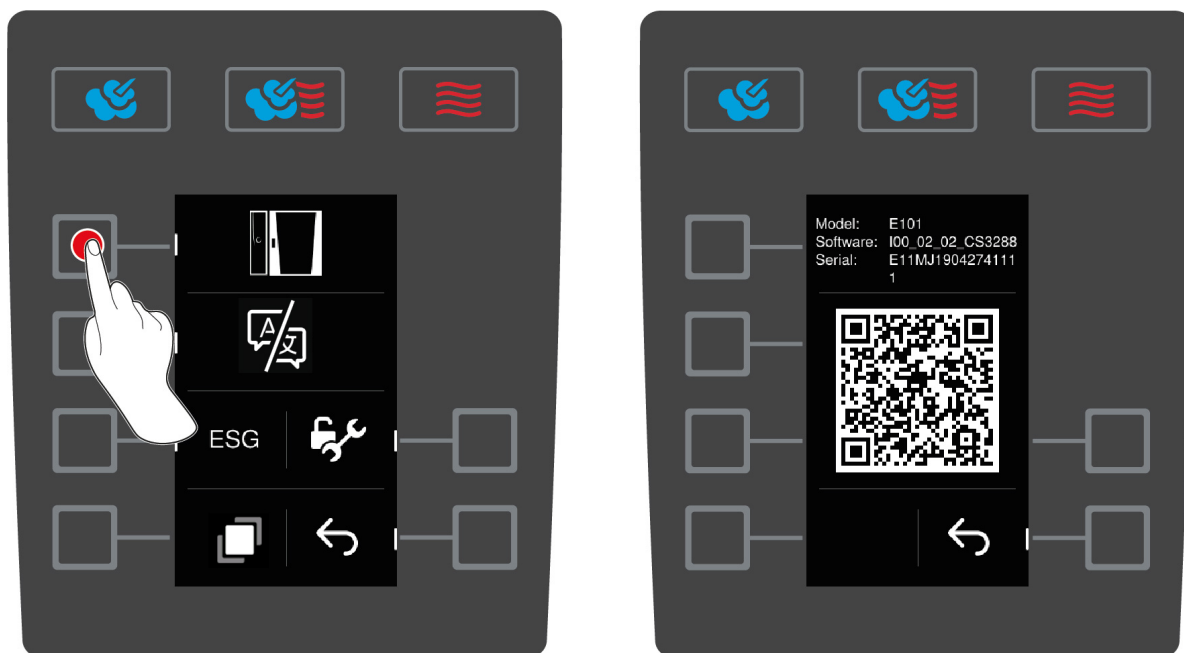

1. On the home screen, press this button: 

2. Press this button: 

You can change the following settings:

- Setting the temperature unit [▶ 37]
- Set date and time [▶ 38]

1. To call up additional settings, press this button: 

You can change the following settings:

- Switching the keyboard [▶ 39]

1. To return to the home screen, press this button: 

### 9.2 Setting the temperature unit

Use this to choose whether to display temperatures in °C or °F.

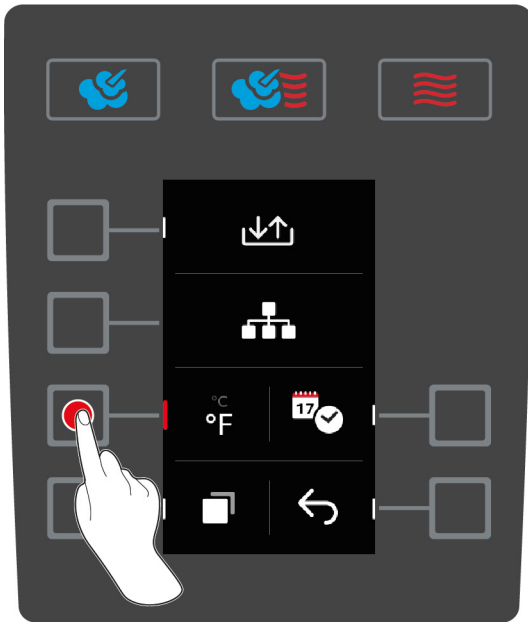

1. On the home screen, press this button: ☰
2. Press this button: ⚙️
3. Press the button and choose °C or °F.

### 9.3 Set date and time

You can change the following settings:

- Date in format DDMMYYYY
- Time in format HH:MM
- Real-time format in 12-hour or 24-hour format

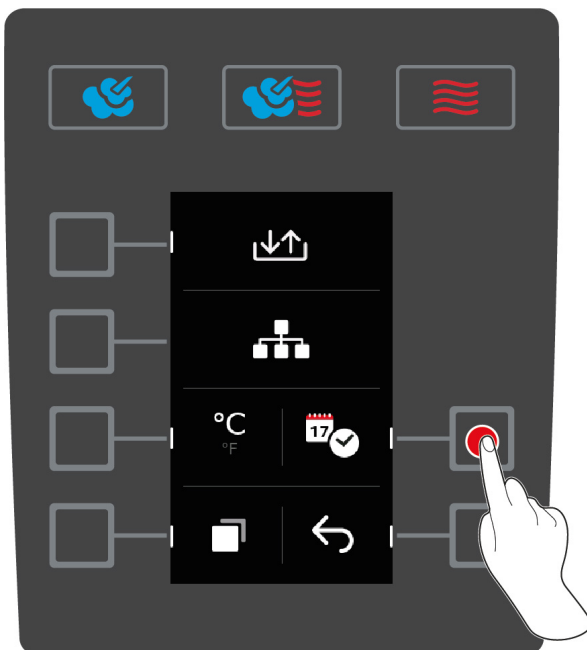

1. On the home screen, press this button: ☰
2. Press this button: ⚙️
3. Press this button: 📅

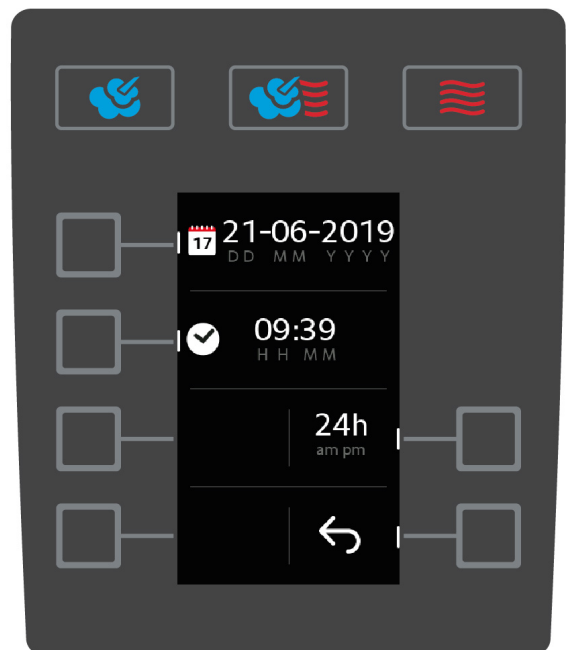

### Changing the date

1. Press this button: 
  - > The **DD** will begin blinking.
2. Turn the central selection knob to adjust the day.
3. Press the central selection knob to confirm your selection.
4. Repeat the process to set the month and year.

### Changing the time

1. Press this button: 
  - > The **HH** will begin blinking.
2. Turn the central selection knob to set the hours.
3. Press the central selection knob to confirm your selection.
4. Repeat the process to set the minutes.



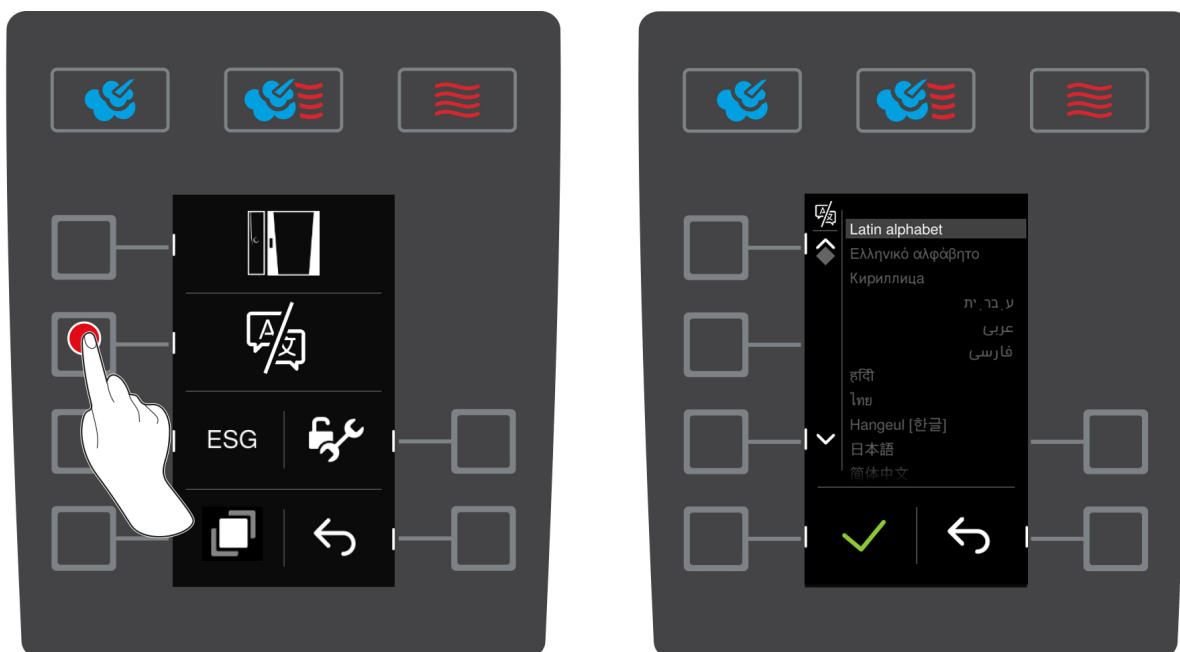

### Changing the real-time format

1. Press this button: 24h
  - > The display will switch to a 12-hour format.

## 9.4 Switching the keyboard







Here you can set which character set should be selected, when you create a new program.





1. On the home screen, press this button: 
2. Press this button: 
3. Press this button: 
4. Press this button: 
  - > A list of the available fonts.
5. Turn the central selection knob to choose a font.
6. Press the central selection knob to confirm your selection.

## 9.5 Setting buzzer & buzzer volume

To modify the buzzer sound profile, proceed as follows:





1. On the home screen, press this button: 
2. Press this button: 
3. Press this button:  twice.
4. Press this button: 
5. Turn the central dial to select a sound profile.
6. Press the central selection knob to confirm your selection.

#### Setting buzzer volume

1. On the home screen, press this button: 
2. Press this button: 
3. Press this button:  twice.
4. Press this button: 
5. Turn the selector to set the volume as desired.
6. To confirm, press this button:  again.

## 9.6 Flushing the hand shower

You have the option of having a reminder shown on the display to rinse the hand shower regularly. Flushing the hand shower with water prevents bacteria from forming in the water within the hose reel or the hand shower.

1. On the home screen, press this button: 
2. Press this button: 
3. Press this button:  twice.
4. Press this button:  to activate the hand shower flush reminder.
5. Press this button:  to deactivate reminders to flush the hand shower

With reminders active, the system will prompt you to flush out the hand shower for 90 seconds every 72 hours. The flushing reminder will also be added to the HACCP log with a date and time stamp.

**TIP:** Press this button:  after 30 seconds to click the message away.

## 10 Kitchen management

### 10.1 Hygiene management

#### 10.1.1 Recorded HACCP data

The following HACCP data is recorded for each batch:



- Batch number
- Cooking system model
- Serial number
- Software and help version
- Date and time
- cleaning program
- Rinse hand shower
- Cooking cabinet temperature
- Target core temperature
- Measured core temperature
- Time (hh.mm.ss)
- Temperature unit
- Connection to energy optimization system
- Opening / shutting of cooking cabinet door
- Change cooking mode
- Automatic cleaning

#### 10.1.2 Download HACCP data

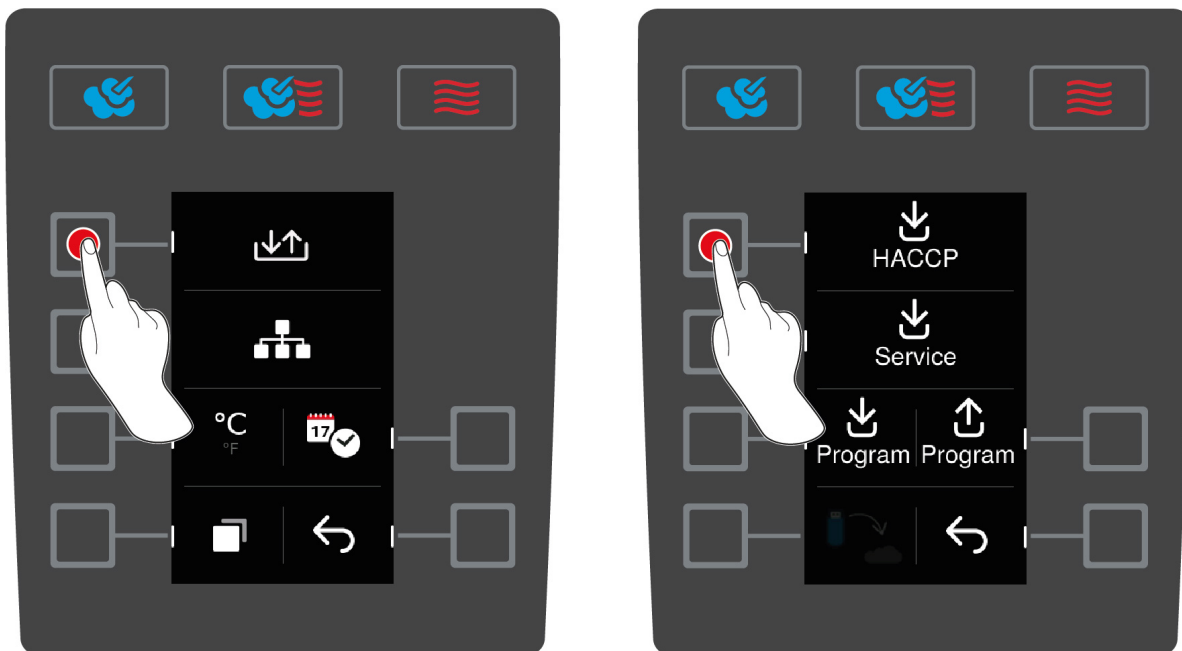
HACCP data is stored on the unit for 28 days. You can download the data during that period.



✓ Start by inserting a USB stick in to the unit.

1. On the home screen, press this button: 
2. Press this button: 
3. Press this button: 

4. Press this button: HACCP

>> Your HACCP data will be downloaded as a .txt file. After downloading the data, you can open it in a word processing program or a spreadsheet program.

## 10.2 Connecting units to a network

### General:

Your iCombi Classic can be connected to a network. This opens up the following features:

- You can monitor cooking system status and cooking progress via ConnectedCooking.
- The iCombi Classic will upload service notifications to ConnectedCooking.
- You can upload programs from the iCombi Classic to ConnectedCooking, and then edit or save them there.
- Programs created in ConnectedCooking can be downloaded to the iCombi Classic and saved there.

### Available options:

**INFO:** In order to connect your cooking system to a network, you will need an optional Ethernet interface (LAN) or an optional WiFi and Ethernet interface (LAN or WLAN). You will need to select these during cooking system configuration and order them at the same time.

The following network connection options are available for the iCombi Classic:

- Ethernet connection (LAN)
- WiFi connection

### Network:

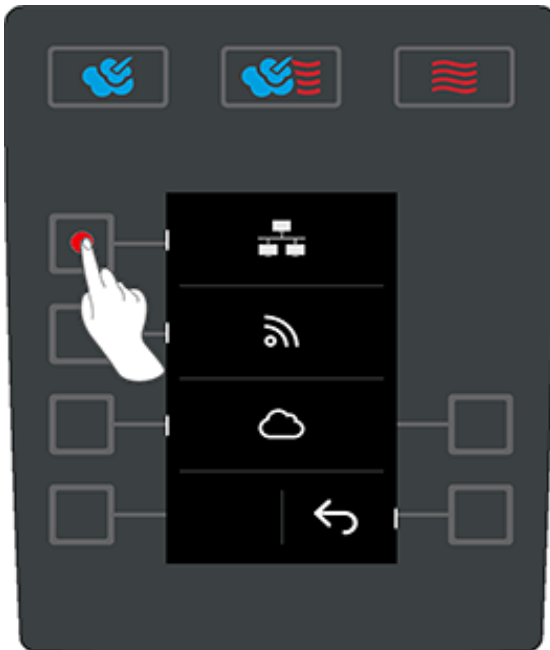

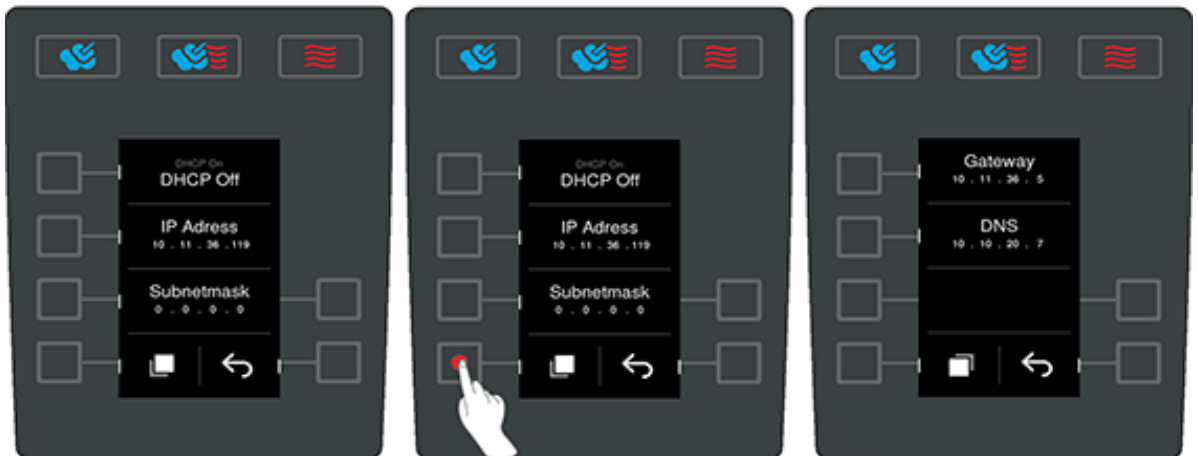

The DHCP number, IP address, subnet mask, gateway, and DNS are displayed here. The MAC address is shown here as well. For example, the network connection can be assigned in a company environment using the unique identifier of the network adapter of the iCombi Classic (MAC address)..

#### WiFi connection:

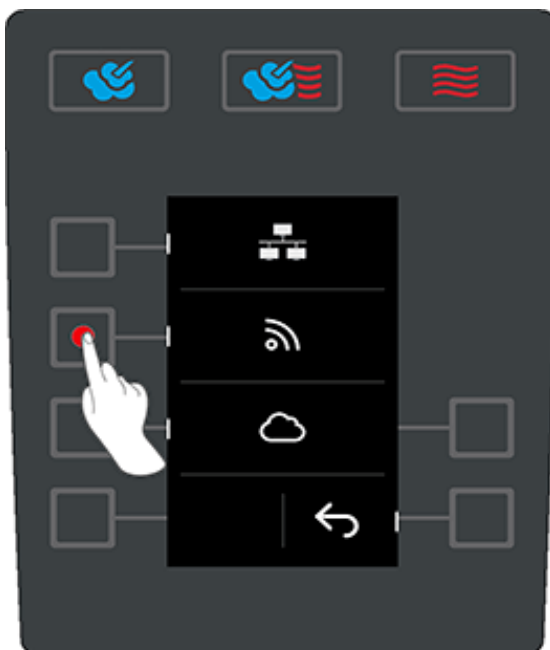

- Press the  button to see WiFi settings.



The current connection status and the most recent network connection will be displayed.

- ✖ = not connected
- ✔ = connected

#### Searching for or changing networks

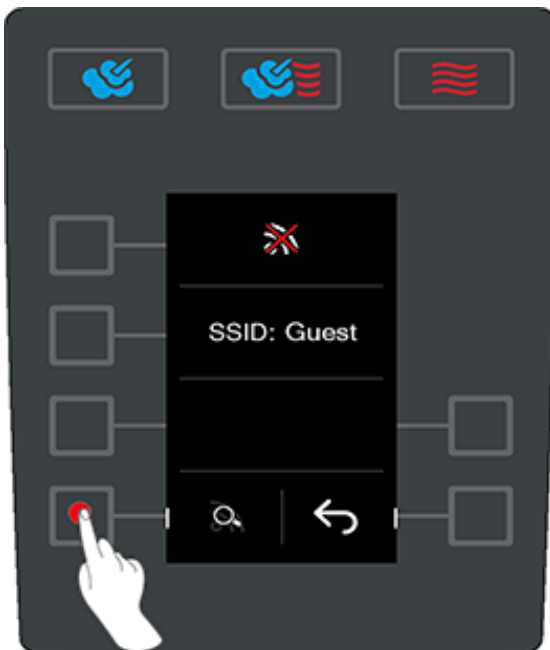

Use the search option to view and select previously saved networks or find new networks.

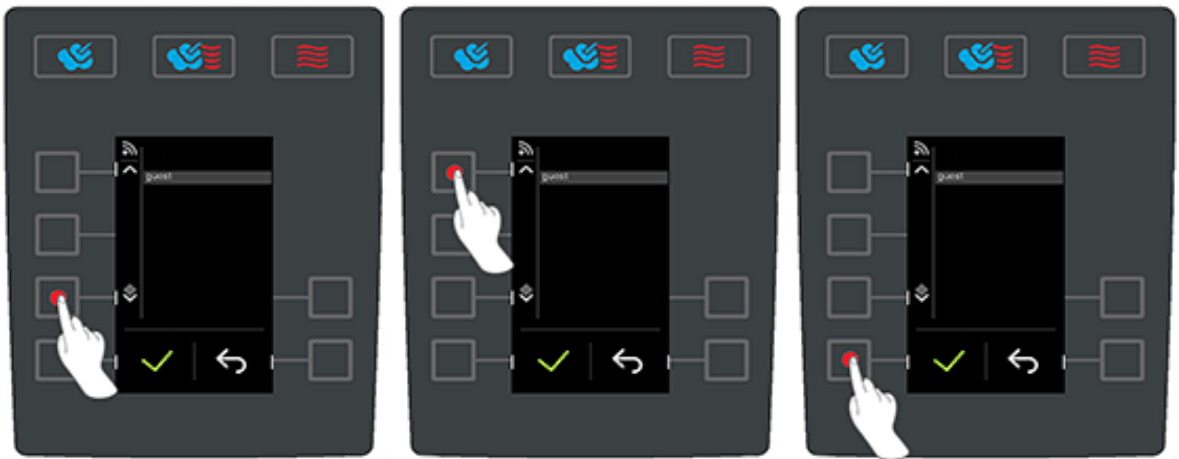

To establish a connection, select a network and confirm by pressing ✓.

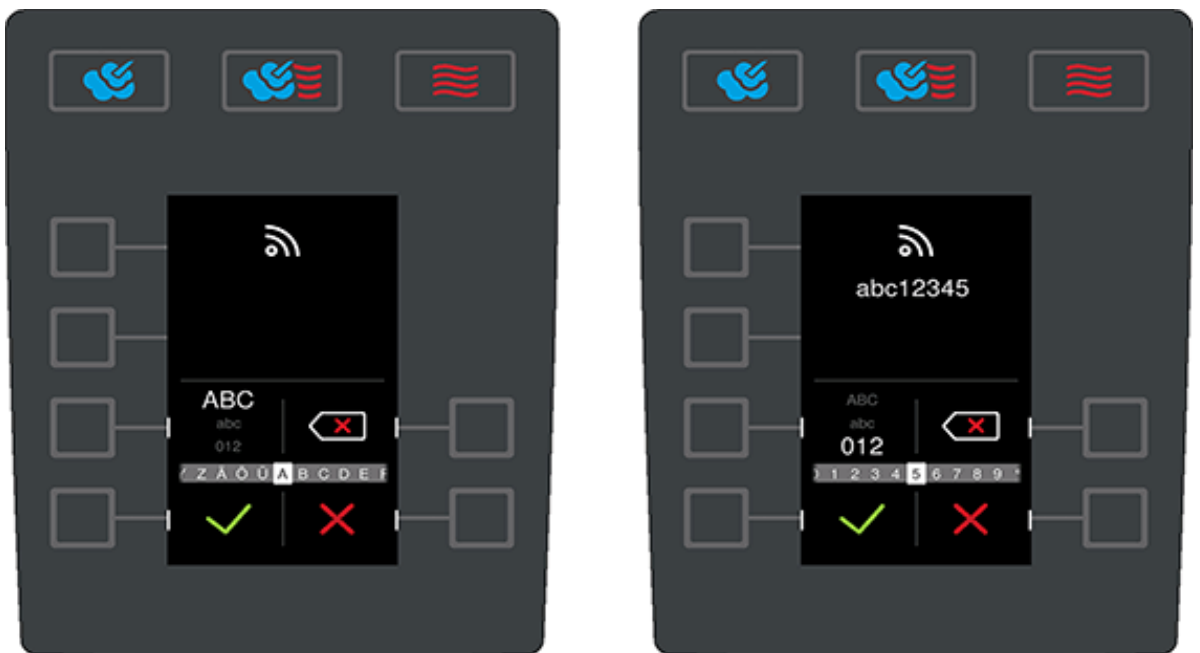

- Enter the WiFi password.

**Confirming input or canceling:**



- Use the selection dial to select letters, numbers, and special characters.
- Press the dial to confirm your selection.
  
- Press ✓ to confirm your input.
- Press ✗ to cancel your selection.

**Connecting to the ConnectedCooking cloud:**

Your iCombi Classic can be registered on ConnectedCooking using an individual activation code. The activation code is generated by the cooking system; in order to register the cooking system, you will need to enter the code to your ConnectedCooking account under [www.connectedcooking.com](http://www.connectedcooking.com).



- Press the ◁ button to access the activation code.

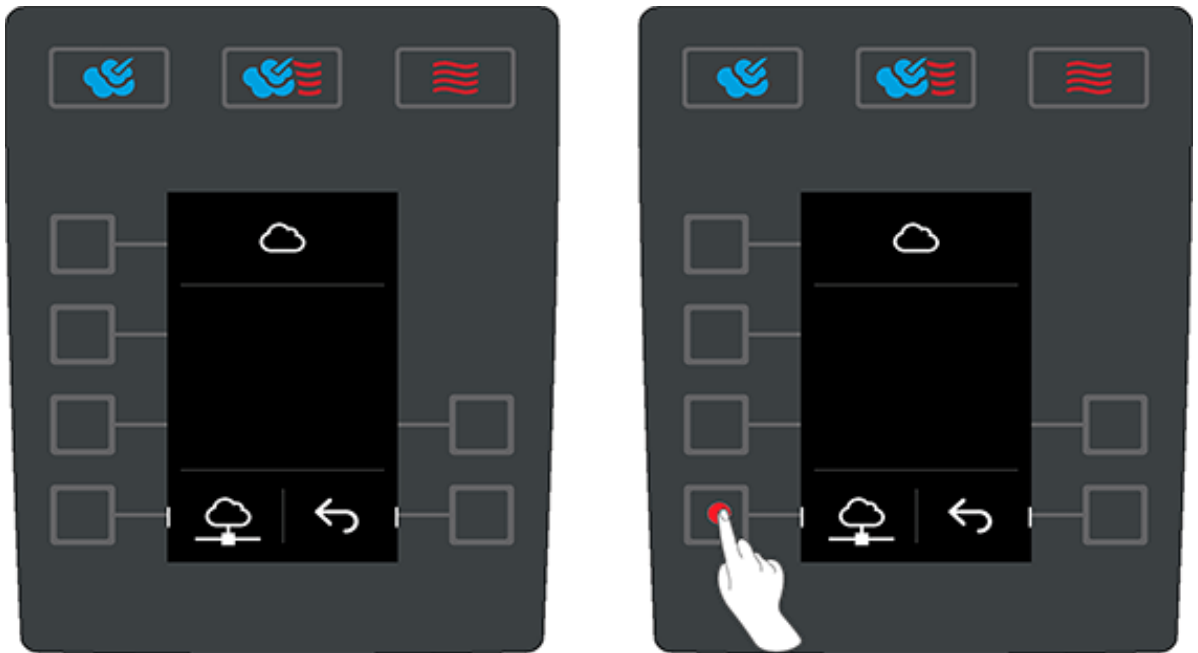

- Press the  button to generate an activation code.

**INFO:** If no activation code is displayed, press  again to generate a new one. It may take a few seconds for the code to appear.



After that, you can use the code to connect your cooking system to ConnectedCooking.

Once the cooking system has been connected, it will be displayed in ConnectedCooking. After you restart the cooking system, hygiene (HACCP) data will automatically be transmitted from the cooking system to ConnectedCooking.

### 10.2.1 Establish WLAN connection

Connecting the unit to a wireless network that requires you to log in via a website will not allow the unit to establish a wireless connection.

1. Press this button:

2. Press this button: **Network**
3. To activate the function, press this button: **ON**
4. Press this button: **Wireless LAN**
  - > A list of all available wireless networks is shown. Wireless networks will be shown in descending order of signal strength.
5. Select the wireless network you wish to use.
  - > You will be prompted to enter the password for the wireless network.
6. To confirm, press this button: ✓
  - > Once the connection has been established successfully, the following symbol appears in the footer:
  - > The wireless network will be displayed at the top of the list of available wireless networks.
7. To view connection details, click this button next to the wireless network: **V**
8. To disconnect from the network, go to the connection details and press this button: **Disconnect**
9. Go to the icon bar and press to return to the network settings overview screen.
  - >> The name of the wireless network will be displayed in the **Wireless network** section.

## 10.2.2 Connecting the network cable

Your cooking system is optionally equipped with an RJ45 Ethernet connection. To connect your cooking system with the network and to ensure that your cooking system is protected in all directions from spraying water, use a network cable with the following properties:

- Network cable category 6
- Maximum plug length of 45 mm
- Plug diameter of 18.5 mm
- Cable diameter of 5.5 – 7.5 mm

### ⚠ CAUTION

**The function parts around the network connection can reach temperatures of over 140 °F**

You may burn yourself when connecting a network cable to a unit that is currently in use or that was recently in use.

1. Allow the unit to cool down before connecting the network cable.

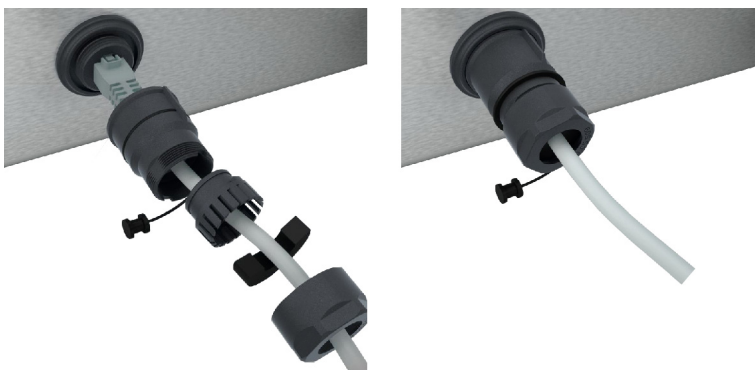

1. Unscrew the protective cover.
2. Feed the individual parts of the protective cover onto the network cable.
3. Connect the network cable to the network connection.
4. Screw on the protective cover.

## 11 Automatic cleaning

Your iCombi Classic is equipped with an automatic cleaning system. Choose a cleaning program, insert the displayed number of Active Green tabs and care tabs, and your unit will clean itself. At the same time, the integrated care system keeps the steam generator free of scale. This gives you a hygienically clean and optimally maintained unit at all times.

### 11.1 General safety information

- Only use the manufacturer's recommended Active Green cleaner tabs and care tabs in automatic cleaning.

To avoid scalding and burn injuries:

- Allow the cooking system and all functional components to cool down before starting automatic cleaning.

To avoid severe chemical burns:

- Cleaning and care products can cause severe eye damage and chemical burns to the skin. Always wear securely fitting safety eyewear and chemical-resistant gloves when cleaning the unit.
- Keep the cooking cabinet door closed during automatic cleaning. Otherwise, hot steam and corrosive cleaning chemicals could escape. If you open the cooking cabinet door during automatic cleaning, a message will appear prompting you to close it again.
- Make sure the core temperature probe is not hanging out of the cooking system while automatic cleaning is in progress. This could damage the seal on the cooking cabinet door and allow corrosive cleaning chemicals to escape.
- Do not clean the externally attached core temperature probes using automatic cleaning.
- Before preheating the cooking system for use, remove all cleaning products and cleaning product residues.

How to respond if you come into contact with cleaning chemicals:

- If you touch cleaning agents when not wearing gloves or your skin otherwise comes into contact with Active Green cleaner tabs, rinse your skin with running water for 10 minutes.
- If you get cleaning chemicals into your eyes, rinse your eyes with running water for 15 minutes. Remove your contact lenses, if applicable.
- If you swallow cleaning chemicals, rinse your mouth out with water and drink two glasses of water immediately. Do not induce vomiting.
- Call the poison control hotline or a doctor immediately.

### 11.2 Cleaning programs

The following cleaning programs are available to you:

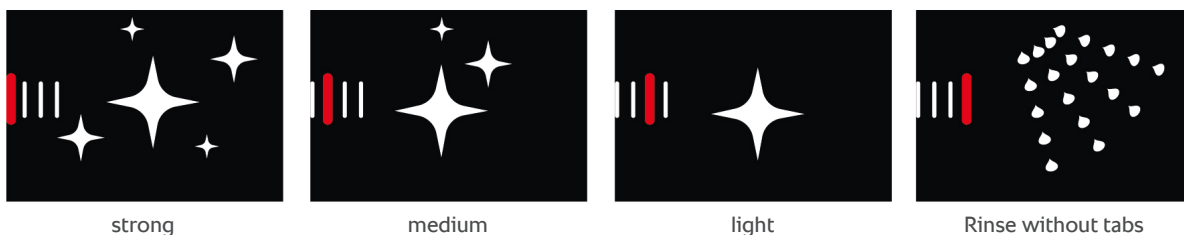

cleaning program	Description	Care product required
light	Suitable for removing minor food residue and limescale accumulated when using the unit at temperatures of up to 392°F.	<ul style="list-style-type: none"> <li>▪ Active Green cleaner tabs</li> <li>▪ Care tabs</li> </ul>
medium	Suitable for removing stains and limescale that have accumulated during cooking paths involving grilling or frying.	<ul style="list-style-type: none"> <li>▪ Active Green cleaner tabs</li> <li>▪ Care tabs</li> </ul>

cleaning program	Description	Care product required
<b>strong</b>	Suitable for removing heavy soiling or significant limescale buildup that has occurred during cooking paths involving grilling or frying.	<ul style="list-style-type: none"> <li>▪ Active Green cleaner tabs</li> <li>▪ Care tabs</li> </ul>
<b>Rinse without tabs</b>	Used to rinse the cooking cabinet with warm water.	–

### 11.3 Starting automatic cleaning

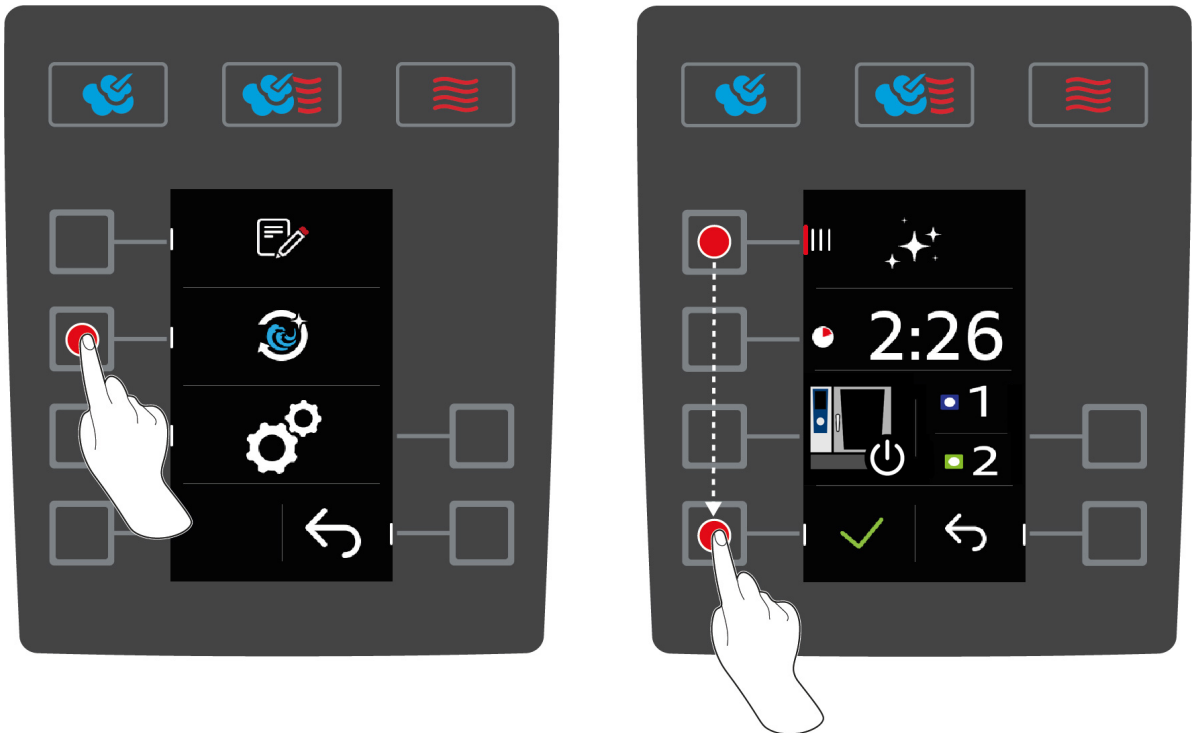

- ✓ The hinging racks are correctly placed in the cooking cabinet.
- 1. On the home screen, press this button:
- 2. Press this button:
- > If the cooking cabinet temperature is above 122°F, this message is displayed: **Cooking cabinet is too hot**
- 3. Start the cool down function to lower the cooking cabinet temperature. More information is available here: Functions
- 4. Press this button:
- 5. Turn the central dial to choose a cleaning program [▶ 49].
- 6. Open the cooking cabinet door.
- 7. Remove any containers and trays from the cooking cabinet.



8. **⚠ WARNING! Danger of chemical burns! Wear mouth protection and chemical-resistant gloves to protect yourself reliably when working with Active Green cleaner tabs and care tabs.** Unwrap the indicated number of Active Green cleaner tabs and place them into the drain sieve in the cooking cabinet.
  9. Unwrap the indicated number of Care tab packages and place them into the care drawer.
  10. Close the cooking cabinet door.
  11. To confirm, press this button: ✓
- >> Automatic cleaning will start.
- >> When automatic cleaning is finished, a signal tone will sound.

**Automatic shut-off after cleaning end**

You can actively set whether the cooking system should switch off automatically after cleaning finishes. By default, automatic shut-off after cleaning is deactivated.

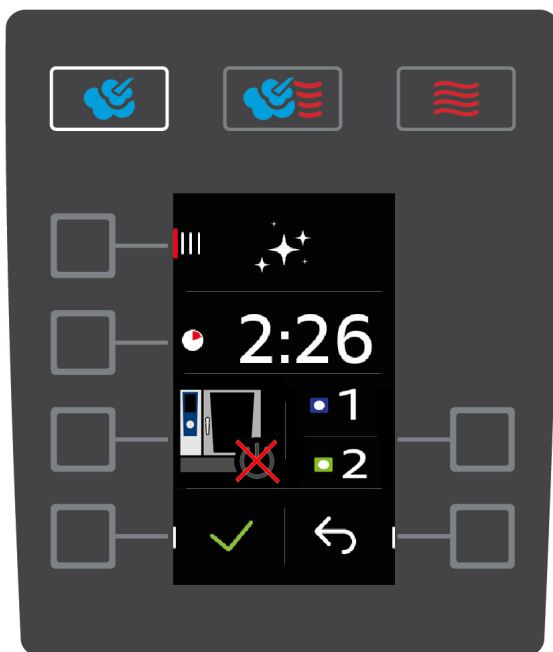

1. Press this button:

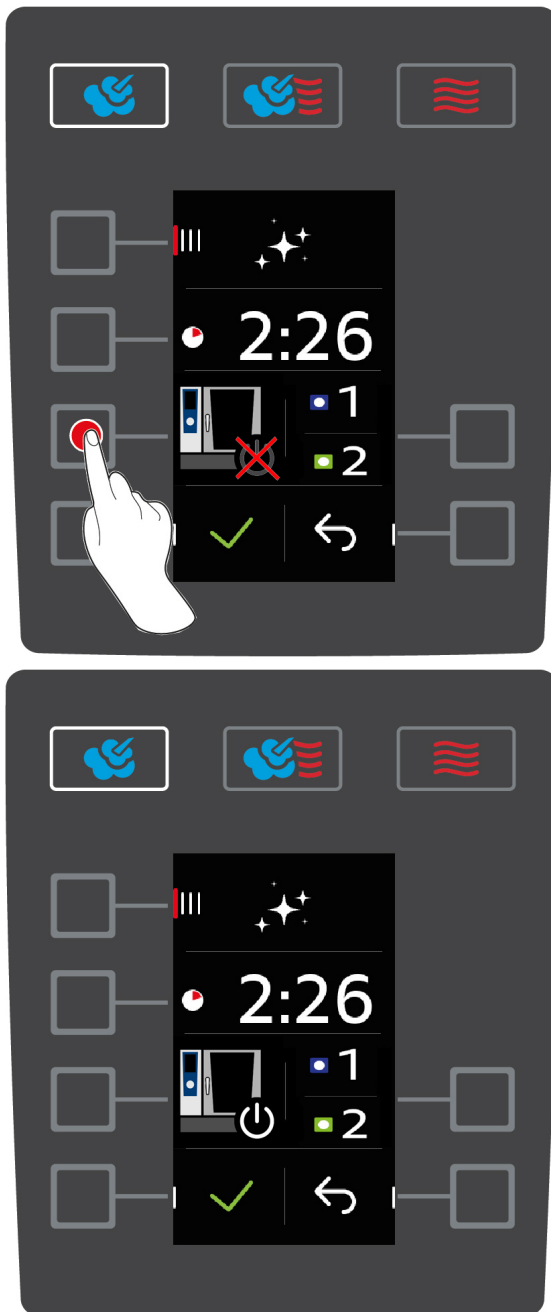

The “automatic shut-off after cleaning end” function is now activated.



#### TIPS

- If foam builds up in the cooking cabinet even though you have used the recommended number of Active Green cleaner tabs, use fewer tabs the next time you run automatic cleaning. If foam continues to build up, please contact your RATIONAL Service Partner.
- You can use the LED lighting to illuminate the cooking cabinet during cleaning. To activate lighting, press this button: 

## 11.4 Canceling automatic cleaning

You can cancel any automatic cleaning programs within 30 seconds of starting them. Once automatic cleaning has started, it can no longer be canceled.

1. Press and hold the button until the status bar is shown in full: 
  - > You will be prompted to open the cooking cabinet door and remove the Active Green cleaner tabs.

2. Open the cooking cabinet door.
3. **⚠ WARNING! Risk of chemical burns! Wear close-fitting protective goggles and chemical-resistant gloves to protect yourself reliably when working with Active Green cleaner tabs.** Remove the Active Green cleaner tabs from the cooking cabinet and dispose of them.
4. Close the cooking cabinet door.
  - > You will be prompted to rinse out the cooking cabinet with the hand shower.
5. Rinse out the cooking cabinet using the hand shower.
6. Close the cooking cabinet door.
  - >> The overview of cleaning programs is shown.

**TIP**

If a power failure occurs during automatic cleaning, automatic cleaning will be interrupted. Once power has been established again, automatic cleaning will resume.

## 12 Care

### WARNING

#### Accumulated grease or food residue in the cooking cabinet

Failure to clean the cooking cabinet sufficiently could result in food residue or accumulated grease creating a fire hazard.

1. Clean the unit daily.
2. If a fire breaks out, leave the cooking cabinet door closed in order to cut off the fire's oxygen supply. Switch the unit off. If the fire has spread, use a fire extinguisher that is suitable for grease fires. Never use water or foam extinguishing agents on grease fires.

### NOTE

#### cleaning request

A cleaning request appears if you have not used a cleaning program including care (light, medium, strong) for a long time. To prevent limescale buildup on your cooking system, you must do at least light cleaning at regular intervals.

### 12.1 General safety information

To avoid scalding and burn injuries:

- Allow the cooking system and all functional components to cool down before cleaning.

To avoid property damage, injury or death:

- Clean the cooking system daily even if you are only using the Steam manual operating mode.
- Do not use the cooking system's automatic cleaning functions to clean accessories.

### 12.2 Care intervals

Care interval	Functional components
Weekly	<ul style="list-style-type: none"> <li>▪ Unit exterior surfaces</li> <li>▪ LED cover</li> <li>▪ Control panel</li> <li>▪ Plastic parts</li> </ul>

At minimum, the functional components must be cleaned in accordance with the care interval; they can be cleaned more frequently if necessary.

### 12.3 Care products

#### Suitable care products

- Clean the following functional components using lukewarm water, a mild detergent, and a soft cloth:
  - Cooking system exterior
  - Cooking cabinet door glass
  - LED cover inside cooking cabinet door
  - Cooking cabinet seal
- Clean accessories using lukewarm water, a mild detergent, and a soft cloth.

#### Unsuitable care products

Do not use any of the following products to clean the unit or its functional components or accessories:

- Scouring agents
- Hydrochloric acid, lye, sulphurous substances, or other oxygen-consuming agents

- Undiluted alcohol, methanol, or solutions such as acetone, benzene, toluene, or xylene
- Oven cleaner or grill cleaner
- Pot scrubber with steel wool
- Steel wool
- High-pressure cleaning jets
- Sharp or pointed tools

## 12.4 Cleaning the cooking cabinet door

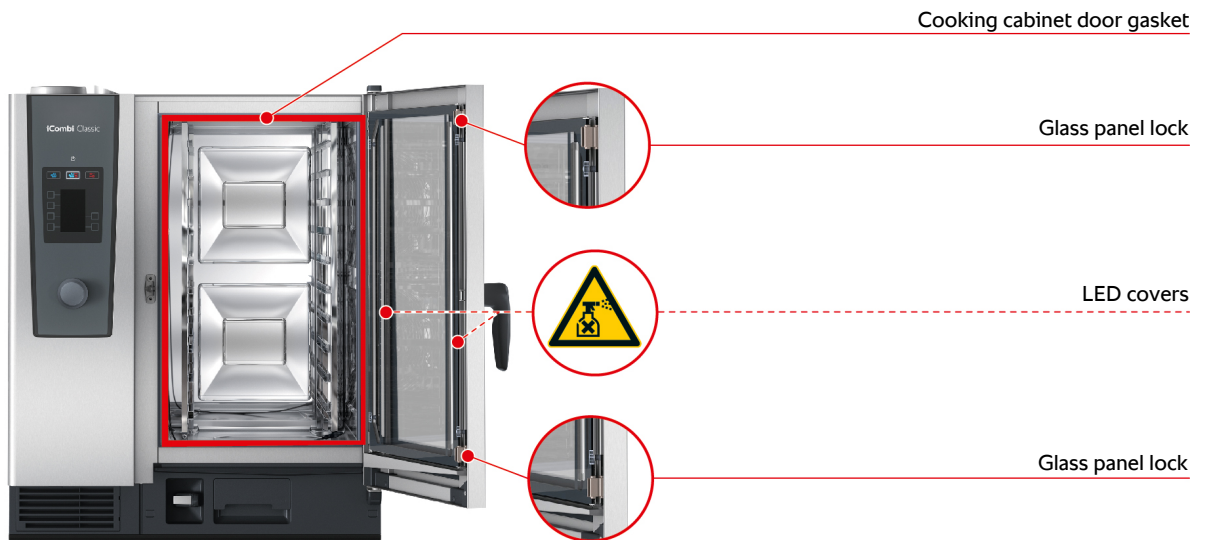

### Cleaning the glass panes

1. Open the cooking cabinet door all the way, until it reaches the stop position.
2. Use light pressure to release the locks on the glass panes.
3. Swing the glass pane on the cooking cabinet door open.
4. Clean the glass panels of the cooking cabinet door with lukewarm water, a mild detergent and a soft cloth.
5. Allow the glass to dry completely.



### Cleaning the LED covers

After cleaning the glass on the cooking cabinet door, you can also clean the LED covers. Use only appropriate care products [► 54] to clean the LED covers.

The LED cover is between the two panes of glass on the cooking cabinet door.

- ✓ Make sure the glass panes on the cooking cabinet door are unlocked.
1. Clean the LED covers with lukewarm water, a mild detergent and a soft cloth.
  2. Remove cleaning agent residues with clean water and a soft cloth.
  3. Allow the LED covers to dry completely.
  4. Lock the pane back into position on the cooking cabinet door.

### Cleaning the cooking cabinet door gasket

Using your cooking system in continuous operation, frequently cooking at high temperatures (above 500 °F), and cooking primarily products containing high levels of fat and gelatin can all accelerate wear on the cooking cabinet door gasket. Daily cleaning can help extend the life of the cooking cabinet door gasket.

- ✓ Start by opening the cooking cabinet door.
1. Clean the cooking cabinet door gasket with lukewarm water, a mild detergent and a soft cloth.
  2. Allow the cooking cabinet door gasket to dry completely.

### Cleaning the door drip pan

Using your cooking system in continuous operation, frequently cooking at high temperatures (above 500°F), and cooking primarily products containing high levels of fat and gelatin can all result in the door drip pan becoming very dirty. Clean it daily to ensure that hygiene standards are maintained.

- ✓ Start by opening the cooking cabinet door.
- 1. Clean the door drip pan with lukewarm water, a mild detergent and a soft cloth.
- 2. Make sure that you have removed cooking residues, accumulated grease, and crusted-on grime.

### Cleaning the outlet on the door drip pan and the flat gasket on the drain opener

- ✓ Start by opening the cooking cabinet door.
- 1. Open the drain opener with one hand on the actuating foot and hold it securely.
- 2. Clean the flat gasket and outlet with a soft cloth, lukewarm water and mild detergent to remove any grease or crusted-on food residues. Hold the steam generator drain opener securely in the open position to prevent unintentional unhooking of the mechanism.
- 3. If the gasket has slipped during cleaning, return it to the correct position.

## 12.5 Cleaning the hand shower

1. Pull the hand shower hose all the way out and hold it in place.
2. Use a soft sponge to clean the hand shower and the hose.
3. To remove stubborn scale deposits, clean the hand shower and the hose using diluted vinegar.

## 12.6 Cleaning the drip pan and discharge spout

1. Open the cooking cabinet door.
2. To clean the drip pan and the discharge spout, pour 1-2 quarts of warm water into the drip pan daily. Do not clean the drip pan using the hand shower.

## 12.7 Cleaning the air filter

### NOTE

#### Spraying water may penetrate into the unit if the air filter is not inserted correctly

Correct attachment of the air filter is the only way of protecting the unit from water spraying in any direction.

1. Slide the air filter into the unit so that it snaps into place.

### NOTE

#### Do not use sharp objects

Do not use sharp objects such as knives to open the air filter cover, as this could damage the filter holder.



#### Tools required

- Screwdriver

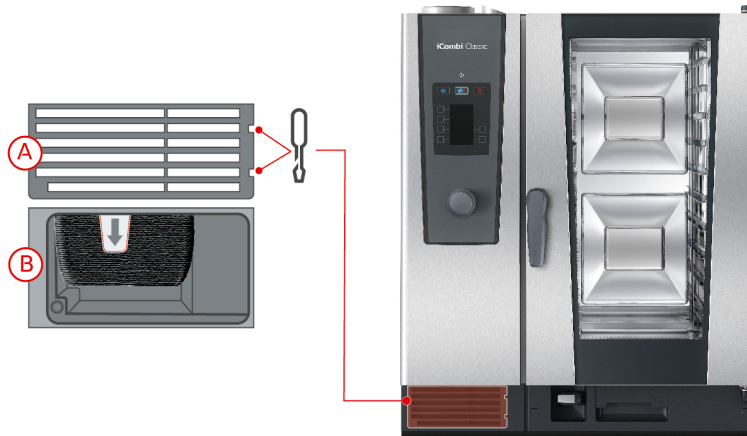

1. Insert a screwdriver into the notches on the air filter cover (A).
2. Remove the cover on the air filter.
3. Pull out the air filter (B).
4. Clean the air filter in the dishwasher and then allow it to dry completely.
  - > If the air filter is not clean after going through the dishwasher, it will need to be replaced.
5. Once the air filter is clean, slide it back into the cooking system.
6. Re-insert the air filter cover into the cooking system.

## 12.8 Cleaning accessories

### NOTE

**Do not leave accessories in the cooking system during automatic cleaning.**

Never leave accessories in the cooking system during automatic cleaning. This can damage the cooking system or the accessories.

1. Allow accessories to cool before cleaning them.
2. Use a soft cloth to remove any traces of food and grease, starch or protein residues.
3. If the stains do not come out easily, soak the accessory in lukewarm water and then use a soft cloth to wipe them clean.

## 12.9 Cleaning the drain ventilation pipe

If your cooking system was connected to a pre-existing siphon at the time of installation, a ventilation pipe was installed on the drain. If your water is soft or the cooking system is connected to a water softening system, and if you frequently use **medium** and **strong** cleaning programs, the foam generated during cleaning will be drained into the ventilation pipe. Clean the ventilation pipe once per week in order to ensure that foam can drain properly.

1. Pour warm water into the ventilation pipe until it is clean and free of residue. Use water at a temperature of 60°C.

## 13 Inspiration and help

### 13.1 Telephone help

#### ChefLine®

Whenever you have application or recipe questions, we'd be happy to provide assistance through our ChefLine. We offer quick, straightforward advice from one chef to another, 365 days a year. Just call the RATIONAL ChefLine®. You can find the number on the ChefLine®sticker on the cooking cabinet door, in the settings under Service and at [rational-online.com](http://rational-online.com).





#### RATIONAL Service Partners

Our cooking systems are reliable and built to last. Should you ever encounter technical issues, our RATIONAL Service Partners can provide fast, efficient assistance. Spare part supplies are guaranteed, and weekend emergency service is included. You can find the number under Settings > Service or at [rational-online.com](http://rational-online.com).

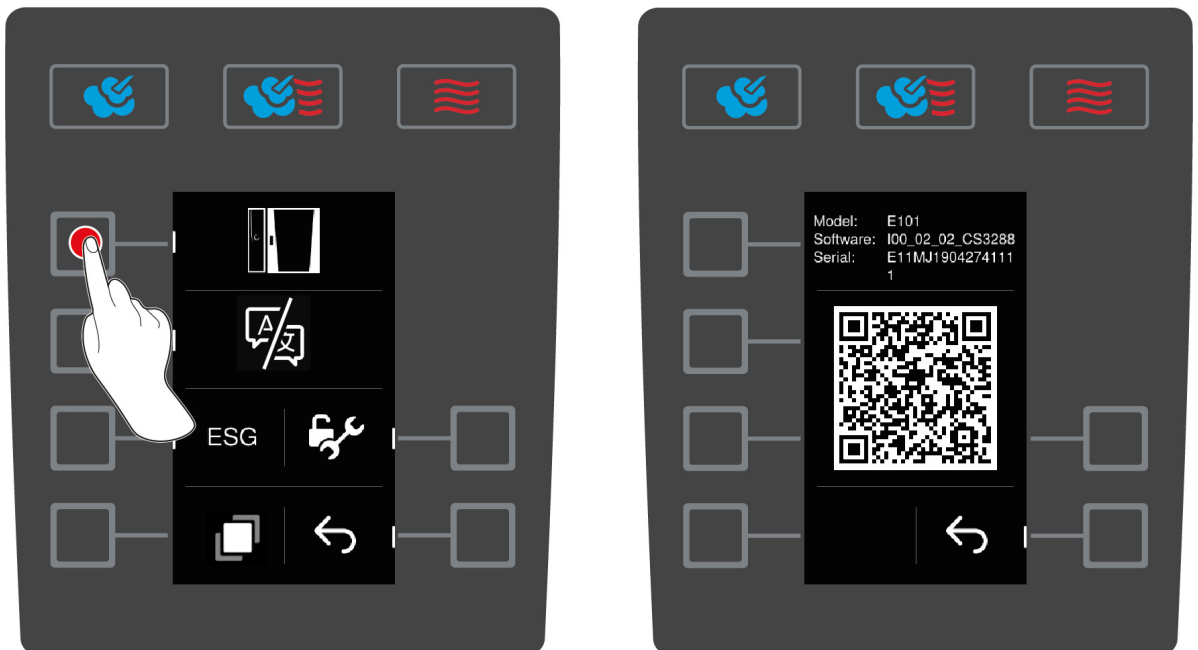
### 13.2 Querying unit data

You can call up information on which software version is installed and view the serial number of your unit. If you have a QR scanner installed on your smartphone, you can also load the information to your smartphone.



1. On the home screen, press this button: 
2. Press this button: 
3. Press this button: 
4. Press this button: 
  - > The following information will be displayed:
    - Unit type
    - Installed software version
    - Unit serial number

Scan the displayed QR code to save the displayed information to your smartphone.

### 13.3 Problem resolution

Please contact your RATIONAL Service Partner [▶ 58] regarding all error messages. Always have the serial number of your unit ready. You can find the serial number on the identification plate.

Info messages may appear that require you to respond or act. In such situations, you as the operator do not need to contact your RATIONAL service partner. [► 58]

### 13.3.1 Error messages heating steam generator

Error report	Cause	Cooking possible
Service 10 SC-automatic failed	SC automation is malfunctioning.	Yes
Service 11 Water supply steam generator failed	The water intake for the steam generator is malfunctioning.	Yes
Service 12 Water volume measurement failed	The water measurement system is malfunctioning.	Yes
Service 13 Water detection failed	Detection of the water level in the steam generator is malfunctioning.	Only hot air mode is available.
Service 20.8 Steam generator sensor failed	Temperature probe defective.	Only hot air mode is available.
Service 28.4 Steam generator too cold Hot air possible	The minimum steam generator temperature has not been reached.	Only hot air mode is available.
Service 42.1 Solenoid valve failed	The water supply is malfunctioning.	Only hot air mode is available.
Service 43.1 Solenoid valve failed	The internal water supply is not closing.	Only hot air mode is available.
Service 46.1 Pump failed	The water supply is malfunctioning.	Yes
Service 46.2 Pump failed	The water supply is malfunctioning.	Yes

### 13.3.2 Error messages for gas units

If your unit is equipped with a gas connection, the following additional error messages may occur. Please contact your RATIONAL Service Partner [► 58] regarding all error messages. Always have the serial number of your unit ready.

Error report	Cause	Cooking possible
Service 32.1 Check gas supply	The gas burner is malfunctioning. Close the shut-off mechanism of the gas line.	No
Service 32.2 Check gas supply	The gas burner is malfunctioning. Close the shut-off mechanism of the gas line.	No
Service 32.3 Check gas supply	The gas burner is malfunctioning. Close the shut-off mechanism of the gas line.	No
Service 33.1 Gas burner failed close gas supply	The gas burner is malfunctioning. Close the shut-off mechanism of the gas line.	No
Service 33.2	The gas burner is malfunctioning.	No

Error report	Cause	Cooking possible
Gas burner failed close gas supply	Close the shut-off mechanism of the gas line.	
Service 33.3 Gas burner failed close gas supply	The gas burner is malfunctioning. Close the shut-off mechanism of the gas line.	No
Service 34.32 Data communication failed	Internal data communication malfunctioning.	Yes
Service 60 Gas system failed	Initialization of the ignition box is malfunctioning. Switch the unit off and on again. If the error is still being displayed, contact your Service Partner.	–

### 13.3.3 Error messages heating hot air

Error report	Cause	Cooking possible
Service 20.1 Cabinet sensor failed	Temperature probe defective.	No
Service 28.1 Steam generator too hot	Steam generator temperature limit exceeded.	No
Service 28.2 Cooking cabinet too hot	Cooking cabinet temperature limit exceeded.	No
Service 34.1 Data communication failed	Internal data communication malfunctioning.	No
Service 34.2 Data communication failed	Internal data communication malfunctioning.	No
Service 34.4 Data communication failed	Internal data communication malfunctioning.	No
Service 42.3 Solenoid valve failed	The water supply is malfunctioning.	The <b>steam injection</b> function is not available.
Service 42.6 Solenoid valve failed	The water supply is malfunctioning.	Yes
Service 43.3 Solenoid valve failed	The internal water supply is not closing.	Only hot air mode is available.

### 13.3.4 Error messages humidity

Error report	Cause	Cooking possible
Service 20.2 Control sensor failed	Temperature probe defective.	Yes
Service 20.4 Humidity sensor failed	Temperature probe defective.	Yes
Service 30 Humidity control failed	Humidity measurement is malfunctioning.	Yes
Service 36 Humidity control failed	Differential pressure sensor defective.	Yes
Service 37	Differential pressure sensor defective.	Yes

Error report	Cause	Cooking possible
Humidity control failed		
Service 42.2 Solenoid valve failed	The water supply is malfunctioning.	Yes
Service 43.2 Solenoid valve failed	The internal water supply is not closing.	Only hot air mode is available.

### 13.3.5 Error messages CleanJet

Error report	Cause	Cooking possible
Service 34.8 Data communication failed	Automatic cleaning is not functioning.	No
Service 43.6 Solenoid valve failed	The internal water supply is not closing.	Only hot air mode is available.
Service 47.1 Pump failed	The wastewater pump is defective.	Yes
Service 47.2 Pump failed	The wastewater pump is defective.	Yes
Service 110 Cleanjet failed	An error occurred in the SC pump during automatic cleaning.	No
Service 120 Cleanjet failed	An error occurred in the water level detection mechanism during automatic cleaning.	No
Service 121 Pour Water 3l	Not enough water in the cleaning agent box	Only hot air mode is available. Pour 3 quarts of water into the cleaning agent box.

### 13.3.6 Error messages Care

Error report	Cause	Cooking possible
Service 42.4 Solenoid valve failed	The water supply is malfunctioning.	Yes
Service 43.4 Solenoid valve failed	The internal water supply is not closing.	Only hot air mode is available.
Service 49.1 Pump failed	The water supply is malfunctioning.	Yes
Service 49.2 Pump failed	The water supply is malfunctioning.	Yes

### 13.3.7 Info messages



Info messages appear in a text box with a blue border, indicating situations that you as the user need to be aware of.

The following information messages may appear:

#### Explanation of symbols:

-  No water flow

Information	Cause	Cooking possible
Energy optimization active	Energy optimization active.	Yes

Steam generator too cold Hot air possible	The minimum steam generator temperature has not been reached.	Only hot air mode is available.
Initialise timer	The CPU's real time clock is not initialized. Set the date and time.	Yes
Battery low	The battery is defective.	Yes
Cabinet light failed	The cooking cabinet lighting is not functioning correctly.	Yes
Selftest with water requested	Self-test was performed without water	Only hot air mode is available.
Pour water 3 litres	Prompt to pour 3 quarts of water into the cleaning agent box	Only hot air mode is available.
Check Watersupply	Level Electrode time out	Only hot air mode is available.
Check USB Stick	The USB stick is faulty	Yes
Pour Water 3l	If an info message is pushed away and pulses are still detected afterwards	Only hot air mode is available.
Program import error	Program error	Yes
Selftest with water requested	Self-test was performed without water	Only hot air mode is available.
 Check Watersupply	Level Electrode time out	Only hot air mode is available.
 Check Watersupply	No water during start-up routine	Only hot air mode is available.
 Pour Water 3l	Not enough water in steam generator	Only hot air mode is available.

### 13.3.8 Notification centre

Error report	Cause	Cooking possible
Service 17 Unit data failed	Unit type error.	No
Service 29 Electric compartment too hot	The PCB is too hot.	No
Service 31.1 Core temperature sensor failed	The core temperature probe in the cooking cabinet is defective.	Yes, but without the core temperature probe.
Service 31.2 Core temperature sensor on emergency run	The core temperature probe in the cooking cabinet is defective.	Yes, but without the core temperature probe.
Service 34.16 Data communication failed	Internal data communication malfunctioning.	Yes
Service 34.64 Data communication failed	Internal data communication malfunctioning.	Yes
Service 34.400 Data communication failed	Internal data communication malfunctioning.	Yes
Service 41	The steam nozzle or steam pipe needs descaling.	The <b>steam injection</b> function is not available.

Error report	Cause	Cooking possible
Service 52.1 Cabinet light failed	The cooking cabinet lighting is not functioning correctly.	Yes
Service 52.2 Cabinet light failed	The cooking cabinet lighting is not functioning correctly.	Yes
Service 72 Safety temperature limiter has been triggered	The operating temperature for a temperature probe has been exceeded.	No
Service 1017 USB Stick error	The USB stick is defective	Yes

### 13.3.9 Error messages when operating the UltraVent

The following error messages may occur when operating your unit with an UltraVent. Please contact your RATIONAL Service Partner [▶ 58] regarding all error messages. Always have the serial number of your unit ready.

Error message	Cause
Service (E) 35	Unit hood not detected.
Service (E) 35.1	The motor on the unit hood is defective.
Service (E) 35.2	Unit hood filter not detected.
Service (E) 35.3	The thermoelement controller is malfunctioning.
Service (E) 35.4	The motor protector for the thermoelement is malfunctioning.
Service (E) 35.5	The UltraVent filter is dirty.
Service (E) 35.6	The UltraVent filter is dirty.
Service (E) 35.7	The UltraVent filter has not been inserted.

## 14 Maintenance

You can perform the following maintenance yourself:

- Replacing air filters [▶ 64]
- Replacing the cooking cabinet door seal [▶ 65]

### 14.1 Replacing air filters

#### NOTE

##### Do not use sharp objects

Do not use sharp objects such as knives to open the air filter cover, as this could damage the filter holder.

#### NOTE

##### Spraying water may penetrate into the unit if the air filter is not inserted correctly

Correct attachment of the air filter is the only way of protecting the unit from water spraying in any direction.

1. Slide the air filter into the unit so that it snaps into place.

#### NOTE

##### Only install dry air filters.

To avoid material damage, make sure that the new air filter is dry before replacing it.



#### Tools required

- Screwdriver

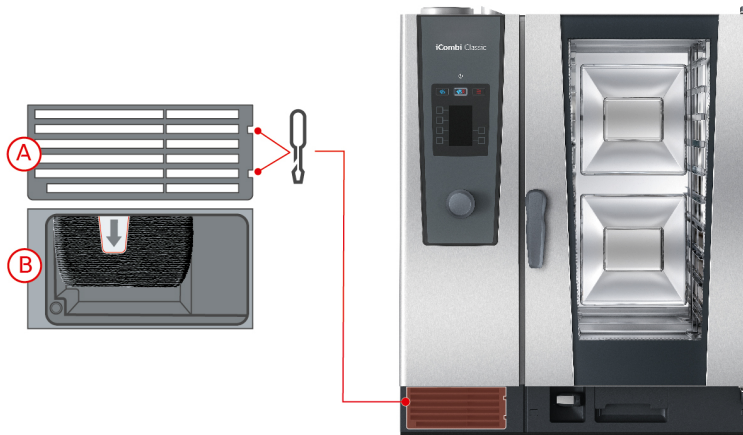

- ✓ A message will appear indicating that the air filter needs to be changed.
1. Insert a screwdriver into the notches on the air filter cover.
  2. Remove the cover on the air filter.
  3. Pull the air filter out.
  4. Slide the new air filter into the cooking system so that it snaps into place.
  5. Re-insert the air filter cover into the cooking system.

## 14.2 Replacing the cooking cabinet door seal







1. Open the cooking cabinet door.
2. Pull the cooking cabinet door gasket out from the groove and dispose of it.
3. Moisten the retaining lips of the new gasket with soapy water.
4. First press the corners of the gasket into the corners of the groove.
5. Then press the rest of the gasket into the groove.

## 15 Transport

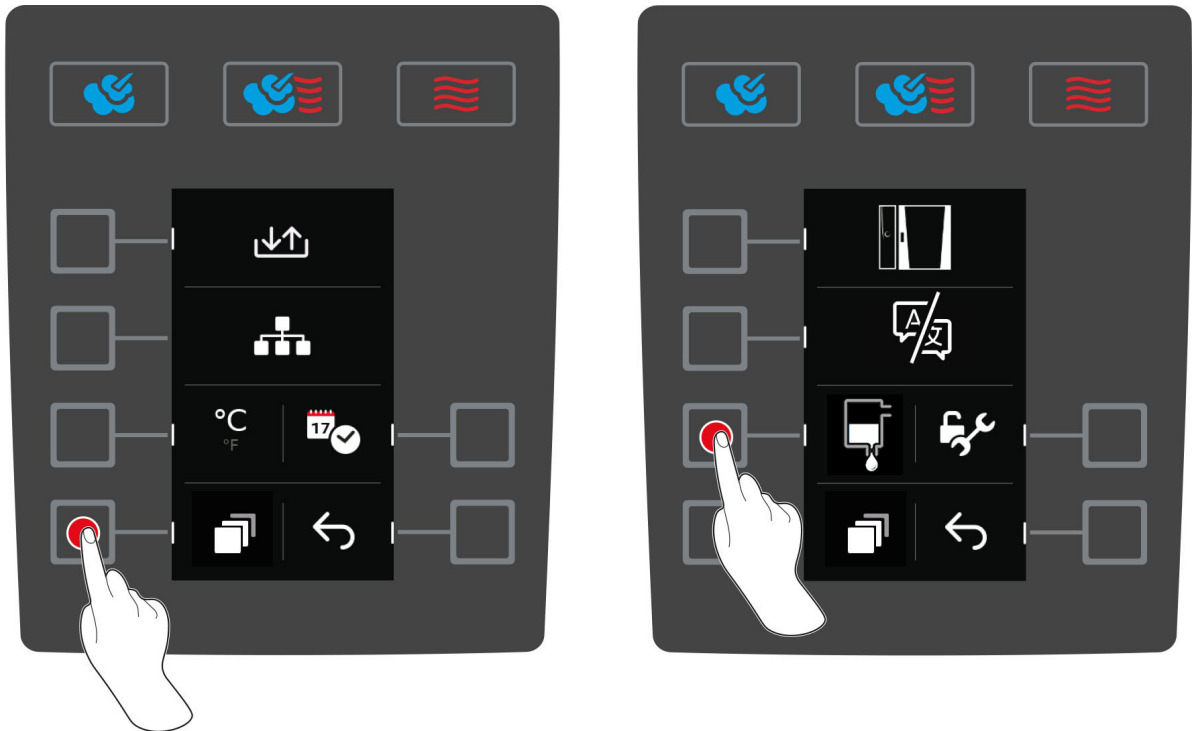
### 15.1 Emptying the steam generator

You will need to drain the steam generator before transporting your cooking system.



1. Disconnect the cooking system from the water supply.
  2. On the home screen, press this button: 
  3. Press this button: 
  4. Press this button: 
  5. Press this button: 
- >> The steam generator will be drained.

### 15.2 Transporting the unit

#### WARNING

##### **Moving the unit or the Combi-Duo with the locking brake on can damage the castors**

Damaged castors can result in the unit or Combi-Duo tipping over and injuring you severely.

1. Always release the locking brake on the castors before transporting or shifting the unit or Combi-Duo.

#### WARNING

##### **Moving the unit or the Combi-Duo with the locking brake on can damage the castors**

Damaged castors can result in the unit or Combi-Duo tipping over and injuring you severely.

1. If the castors underneath the unit or the stand are visible and you want to point the castors in a different direction, release the locking brake before turning the castors.
2. Do not kick the castors.

### ⚠ CAUTION

#### Units may tip over when transported over thresholds or non-level surfaces

Pushing units across thresholds or along non-level surfaces can result in the unit tipping over and injuring you.

1. Exercise caution when moving units across thresholds or on non-level surfaces.

### ⚠ CAUTION

#### Units and Combi-Duos on castors can tip over when being transported or moved

If your unit or Combi-Duo is on castors or a stand with castors, failing to release the locking brake before transporting or shifting the unit or Combi-Duo can cause it to tip over and injure you.

1. Always release the locking brake on the castors before transporting or shifting the unit or Combi-Duo.
2. After transport, lock the locking brake on the castors again.

### NOTE

**Ask your service partner to transport your cooking system in order to guarantee proper operation.**

You can move cooking systems that are on mobile stands or casters.

✓ The steam generator is emptied and the cleaning box is pumped out [► 66]. **Both of these may only be done by a service partner.**

1. Before transporting the cooking system to a different location, you will need to disconnect it properly from all water, wastewater, and power supply lines.
2. After moving the cooking system to its new location, make sure to reconnect it properly to power, water and wastewater lines, and activate the locking brakes on the mobile stand or the casters.



3. If you want to pull the cooking system out while cleaning the kitchen, release the locking brakes on the mobile stand or the casters,
4. and then carefully pull the cooking system forward.
5. Once you are finished cleaning the kitchen, push the cooking system carefully back into position and activate the locking brakes.

## 16 Decommissioning and disposal

### 16.1 Decommissioning

If you want to take your unit out of operation, please contact your RATIONAL Service Partner.

### 16.2 Disposal



Old cooking systems contain recyclable materials. Dispose of old cooking systems in an environmentally safe way, using appropriate collection systems.

## 17 Technical data

Please also note the technical information on the identification plate, which is to the left of the control panel.

### 17.1 Units with electrical connections

	Value
Weight (without packaging) Model 6-half size	lbs
Weight (without packaging) Model 6-full size	lbs
Weight (without packaging) Model 10-half size	lbs
Weight (without packaging) Model 10-full size	lbs
Protection class	IPX5
Airborne sound emission	≤60 dBA
Ambient conditions	50 – 104 °F
WLAN Standard	IEEE 802.11 b/g/n
Frequency and max. transmission power WLAN	2.4 GHz / 40.7 mW

### 17.2 Units with gas connections

	Value
Weight (without packaging) Model 6-half size	243 lbs
Weight (without packaging) Model 6-full size	324 lbs
Weight (without packaging) Model 10-half size	315 lbs
Weight (without packaging) Model 10-full size	412 lbs
Protection class	IPX5
Airborne sound emission	≤60 dBA
Ambient conditions	50 – 104 °F
WLAN Standard	IEEE 802.11 b/g/n
Frequency and max. transmission power WLAN	2.4 GHz / 40.7 mW

### 17.3 Sizes and model names

The size indication and the model name on the identification plate are different. Please consult this table for guidance.

Type	Model name
LMxxxB	iCombi Classic 6-half size
LMxxxC	iCombi Classic 6-full size
LMxxxD	iCombi Classic 10-half size
LMxxxE	iCombi Classic 10-full size

## 17.4 Conformity

### 17.4.1 Units with electrical connections

This unit conforms to the following EU directives:

- Directive 2014/53/EU on the harmonisation of the laws of the Member States relating to the making available on the market of radio equipment
- Directive 2006/42/EU on machinery
- Directive 2014/30/EU on the harmonisation of the laws of the Member States relating to electromagnetic compatibility

- Directive 2011/65/EU on the restriction of the use of certain hazardous substances in electrical and electronic equipment, including 2015/863/EU

This unit conforms to the following European standards:

- EN 60335-1:2012 + A11:2014 + A13:2017
- EN 60335-2-42:2002 + A1:2008 + A11:2012
- EN 61000-3-2:2014; EN 61000-3-3:2013
- EN 55014-1:2006+A1:2009+A2:2011; EN55014-2:2015
- EN 62233:2008
- EN 1717:2000

This unit complies with the following directives for the USA and Canada:

- UL 197 - Standard for Commercial Electric Cooking Appliances
- CSA C22.2 No. 109 – Commercial Cooking Appliances

## 17.4.2 Units with gas connections

This unit conforms to the following EU directives:

- Regulation (EU) 2016/426 on appliances burning gaseous fuels
- Directive 2014/53/EU on the harmonisation of the laws of the Member States relating to the making available on the market of radio equipment
- Directive 2006/42/EU on machinery
- Directive 2014/30/EU on the harmonisation of the laws of the Member States relating to electromagnetic compatibility
- Directive 2011/65/EU on the restriction of the use of certain hazardous substances in electrical and electronic equipment, including 2015/863/EU

This unit conforms to the following European standards:

- EN 60335-1:2012 + A11:2014 + A13:2017
- EN 60335-2-42:2002 + A1:2008 + A11:2012
- EN 60335-2-102:2016
- EN 61000-3-2:2014; EN 61000-3-3:2013
- EN 55014-1:2006+A1:2009+A2:2011; EN55014-2:2015
- EN 62233:2008
- EN 203-1:2014; EN203-2-2:2006; EN 203-3-:2009
- EN 1672-1:2014
- EN 1717:2000

This unit complies with the following directives for the USA and Canada:

- UL 197 - Standard for Commercial Electric Cooking Appliances
- CSA C22.2 No. 109 – Commercial Cooking Appliances

## 18 Regulatory Information

### Canada

This device complies with Industry Canada license-exempt RSS standard(s). Operation is subject to the following two conditions:

- (1) this device may not cause interference, and
- (2) this device must accept any interference, including interference that may cause undesired operation of the device.

IC: 25504-LM2

### USA

This device complies with part 15 of the FCC Rules. Operation is subject to the following two conditions:

- (1) This device may not cause harmful interference, and
- (2) this device must accept any interference received, including interference that may cause undesired operation.

This equipment has been tested and found to comply with the limits for a Class A digital device, pursuant to part 15 of the FCC Rules. These limits are designed to provide reasonable protection against harmful interference when the equipment is operated in a commercial environment. This equipment generates, uses, and can radiate radio frequency energy and, if not installed and used in accordance with the instruction manual, may cause harmful interference to radio communications. Operation of this equipment in a residential area is likely to cause harmful interference in which case the user will be required to correct the interference at his own expense.

FCC ID: 2AUI6-LM2

Le présent appareil est conforme aux CNR d'Industrie Canada applicables aux appareils radio exempts de licence. L'exploitation est autorisée aux deux conditions suivantes:

- (1) l'appareil ne doit pas produire de brouillage, et
- (2) l'utilisateur de l'appareil doit accepter tout brouillage radioélectrique subi, même si le brouillage est susceptible d'en compromettre le fonctionnement.

IC: 25504-LM2

## Directory of keywords

### A

Air filter	
Cleaning	57

### C

Care	
Accessories	57
Care products	
Suitable cleaners	54
Unsuitable cleaners	54
Cleaning	
Air filter	57
Cooking cabinet door	55
Cooking cabinet door gasket	55
LED cover	55
Cleaning programs	
Light	49
Medium	49
Rinse without tabs	50
Strong	50
Cleaning	55
Cleaning the LED covers	55
Continuous operation	31
Cooking cabinet climate	
Combi mode	34
Finishing	21
Hot air	35
Steam	33
Cooking cabinet door	
Cleaning	55
Cleaning the LED covers	55
Cleaning the seal	55
Cooking cabinet temperature	31
Combi mode	34
Finishing	21
Hot air	35
Steam	33
Cooking time	31
Cool down function	32
Core temperature	31
core temperature probe	
Baked goods	17
Fish fillets	17
Inserting core temperature probes	15
Large pieces of meat	16
Removing	17
Small products	17
Steak	16
Vegetables	17
Whole chicken	16
Whole fish	17

### F

Fan speed	32
-----------	----

### G

Gas smell	9
-----------	---

### H

Hand shower	18
Spray	18

### M

Maintenance	
Replace gasket	65
Replacing air filters	64

### O

Operating the unit	
Gestures	10
Selection dial	10

### P

Performing maintenance yourself	64
Preheating	32
Programming a cooking step	26
Programming manual preheating	26
Programming mode	
Adding a cooking step	28
Deleting a cooking step	28
Editing cooking parameters	28

### R

Replace gasket	65
Replacing air filters	64
Rinse without tabs	50

### S

Selection dial	10
Sous-vide cooking	
Areas of use	20
Cook and Chill	20
Room service	20
Special diets	20
Starting programs	27
Switching the unit off	10
Switching the unit on	10







**RATIONAL AG**

Siegfried-Meister-Straße 1

86899 Landsberg am Lech

Tel. +49 (0)8191 3270

Fax +49 (0)8191 21735

[info@rational-online.com](mailto:info@rational-online.com)

[rational-online.com](http://rational-online.com)