

OPERATOR'S MANUAL

This manual provides information on installation, operating, maintenance, trouble shooting & replacement parts for

9900SCA Series / Drop-In Cold Pans



NOTIFY CARRIER OF DAMAGE AT ONCE.

It is the responsibility of the consignee to inspect the container upon receipt of same and to determine the possibility of any damage, including concealed damage. Unified Brands suggests that if you are suspicious of damage to make a notation on the delivery receipt. It will be the responsibility of the consignee to file a claim with the carrier. We recommend that you do so at once.



525 South Coldwater Road • Weidman, MI 48893
888-994-7636 • Fax 888-864-7636 • unifiedbrands.net

Table of Contents

page 2.....	Congratulations
page 3.....	Parts & Service Hotline
page 3.....	Serial Number Location
page 4-7.....	Randell Limited Warranty
page 8.....	Unit Specifications
page 9-13.....	Unit Installation
page 14-15.....	Unit Operation
page 15-16.....	Preventative Maintenance
page 17.....	Electrical Diagram
page 18.....	Troubleshooting
page 19-20.....	Replacement Parts

Congratulations on your recent purchase of Randell food service equipment, and welcome to the growing family of satisfied Randell customers.

Our reputation for superior products is the result of consistent quality craftsmanship. From the earliest stages of product design to successive steps in fabrication and assembly, rigid standards of excellence are maintained by our staff of designers, engineers, and skilled employees.

Only the finest heavy-duty materials and parts are used in the production of Randell brand equipment. This means that each unit, given proper maintenance will provide years of trouble free service to its owner.

In addition, all Randell food service equipment is backed by some of the best warranties in the food service industry and by our professional staff of service technicians.

Retain this manual for future reference.

NOTICE: Due to a continuous program of product improvement, Unified Brands reserves the right to make changes in design and specifications without prior notice.

NOTICE: Please read the entire manual carefully before installation. If certain recommended procedures are not followed, warranty claims will be denied.

MODEL NUMBER _____
SERIAL NUMBER _____
INSTALLATION DATE _____

SERIAL & DATA TAG LOCATION:



Located on underside of unit near drain.

800-621-8560	Randell Service and Parts Hotline
---------------------	----------------------------------------------

Warranty Policies

Unified Brands believes strongly in the products it builds and backs them with the best warranty in the industry. Standard with every unit comes the peace of mind that this unit has been thoroughly engineered, properly tested and manufactured to excruciating tolerances, by a manufacturer with over 30 years of industry presence. On top of that front end commitment, Unified Brands has a dedicated staff of certified technicians that monitor our own technical service hotline at **1-800-621-8560** to assist you with any questions or concerns that may arise after delivery of your new Randell brand equipment.

PARTS WARRANTY

1. One year parts replacement of any and all parts that are found defective in material or workmanship. Unified Brands warrants all component parts of manufactured new equipment to be free of defects in material or workmanship, and that the equipment meets or exceeds reasonable industry standards of performance for a period of one year from the date of shipment from any Randell factory, assembly plant or warehouse facility.

NOTE: warranties are effective from date of shipment, with a thirty day window to allow for shipment, installation and set-up. In the event equipment was shipped to a site other than the final installation site, Randell will warranty for a period of three months following installation, with proof of starting date, up to a maximum of fifteen months from the date of purchase.

2. Free ground freight of customer specified location for all in warranty parts within continental U.S. Component part warranty does not cover glass breakage or gasket replacement. Unified Brands covers all shipping cost related to component part warranty sent at regular ground rates (UPS, USPS). **Freight or postage incurred for any express or specialty methods of shipping are the responsibility of the customer.**

LABOR COVERAGE

In the unlikely event a Randell brand unit fails due to defects in materials or workmanship within the first ninety days, Unified Brands agrees to pay the contracted labor rate performed by an **Authorized Service Agent (ASA)**. Any warranty work performed by a non-ASA will not be honored by Unified Brands. A complete listing of current ASAs can be found on the Randell page of our web site : www.unifiedbrands.net. Warranties are effective from date of shipment, with a thirty day window to allow for shipment, installation and setup. Where equipment is shipped to any site other than final installation, Unified Brands will honor the labor warranty for a period of ninety days following installation with proof of starting date, up to a maximum of six months from date of purchase.

Temperature adjustments are not covered under warranty, due to the wide range of ambient conditions.

For warranty inquiries call our Field Service Department at: 1-800-621-8560.

WHEN OPTIONAL 5 YEAR COMPRESSOR WARRANTY APPLIES

1. Provide reimbursement to an ASA for the cost of locally obtained replacement compressor in exchange for the return of the defective compressor sent back freight prepaid. Note: Unified Brands does limit amount of reimbursement allowed and does require bill from local supply house where compressor was obtained (customer should not pay servicing agent up front for compressor).
2. Provide repair at the manufacturing facility by requiring that the defective unit be sent back to Unified Brands freight prepaid. Perform repair at the expense of Unified Brands and ship the item back to the customer freight collect.
3. Furnish complete condensing unit freight collect in exchange for the return of the defective compressor sent back freight prepaid. (Decisions on whether or not to send complete condensing units will be made by Randell's Field Service technician).

WHEN OPTIONAL LABOR EXTENSION POLICY APPLIES

Unified Brands will provide reimbursement of labor to an ASA for any customer that has an optional labor extension of our standard warranty. (Contracted rates do apply) Unified Brands offers both 1 and 2 year extensions. Labor extensions begin at the end of our standard warranty and extend out 9 months to 1 calendar year or 21 months to 2 calendar years from date of purchase. Please contact Randell technical service hotline at 1-800-621-8560 for details and any question on **Authorized Service Agents (ASA)**.

WHEN EXPORT WARRANTIES APPLY

1. Unified Brands covers all non-electrical components under the same guidelines as our standard domestic policy.
2. All electrical components operated on 60 cycle power are covered under our standard domestic policy.
3. All electrical components operated on 50 cycle power are covered for 90 days from shipment only.
4. Extended warranty options are not available from the factory.

ITEMS NOT COVERED UNDER WARRANTY

1. Maintenance type of repairs such as condenser cleaning, temperature adjustments, clogged drains and unit leveling.
2. Unified Brands does not cover issues that are the result of improper installation. Examples include improper voltage, adequate ventilation, or incorrect plumbing.

NOTICE: FOOD LOSS IS NOT COVERED UNDER WARRANTY

3. Repairs caused by abuse such as broken glass, freight damage, excessive force, or scratches and dents.
4. Electrical component failure due to water damage from cleaning procedures.

5. Insufficient service access openings in the counter/cabinet supplied by others. Lack of access could lead to increased repair times that exceed standard allowances.

QUOTATIONS

Verbal quotations are provided for customer convenience only and are considered invalid in the absence of a written quotation. Written quotations from Unified Brands are valid for 30 days from quote date unless otherwise specified. Unified Brands assumes no liability for dealer quotations to end-users.

SPECIFICATION & PRODUCT DESIGN

Due to continued product improvement, specification and product design may change without notice. Such revisions do not entitle the buyer to additions. Changes or replacements for previously purchased equipment.

SANITATION REQUIREMENTS

Certain areas require specific annotation requirements other than N.S.F. & U.L. standards. Unified Brands must be advised of these specifications before fabrication of equipment. In these special circumstances, a revised quotation may be required to cover additional costs. Failure to notify Randell before fabrication holds the dealer accountable for all additional charges.

CANCELLATIONS

Orders canceled prior to production scheduling entered into engineering/production and cancelled are subject to a cancellation charge (contact factory for details).

STORAGE CHARGES

Unified Brands makes every effort to consistently meet our customer's shipment expectations. If after the equipment has been fabricated, the customer requests delay in shipment, and warehousing is required:

1. Equipment held for shipment at purchasers request for a period of 30 days beyond original delivery date specified will be invoiced and become immediately payable.
2. Equipment held beyond 30 days after the original delivery date specified will also include storage charges.

SHIPPING & DELIVERY

Unified Brands will attempt to comply with any shipping, routing or carrier request designated by dealer, but reserves the right to ship merchandise via any responsible carrier at the time equipment is ready for shipment. Unified Brands will not be held responsible for any carrier rate differences; rate differences are entirely between the carrier and purchaser. Point of shipping shall be determined by Unified Brands (Weidman, MI/Jackson, MS). At dealer's request, Unified Brands will endeavor whenever practical to meet dealer's request. Freight charges to be collect unless otherwise noted.

DAMAGES

All crating conforms to general motor carrier specifications. To avoid concealed damage, we recommend inspection of every carton upon receipt.

In the event the item shows rough handling or visible damage to minimize liability, a full inspection is necessary upon arrival. Appearance of damage will require removing the crate in the presence of the driver. **A notation must be placed on the freight bill and signed for by the truck driver at the time of delivery.** Any and all freight damage that occurs to a Randell piece of equipment as a result of carrier handling is not considered under warranty, and is not covered under warranty guidelines. Any freight damage incurred during shipping needs to have a freight claim filed by the receiver with the shipping carrier. Consignee is responsible for filing of freight claims when a clear delivery receipt is signed. Claims for damages must be filed immediately (within 10 days) by the consignee with the freight carrier and all cartons and merchandise must be retained for inspection.

RETURNED GOODS

Authorization for return must first be obtained from Randell before returning any merchandise. Any returned goods shipment lacking the return authorization number will be refused, all additional freight costs to be borne by the returning party. Returned equipment must be shipped in original carton, freight prepaid and received in good conditions. Any returned merchandise is subject to a minimum handling charge (consult factory for rate).

INSTALLATION

Equipment installation is the responsibility of the dealer and/or their customer. Randell requires all equipment to be professionally installed to ensure adequate voltage and amperage requirements are met. Adequate service access must be provided in counters that are not supplied by the factory.

PENALTY CLAUSES

Dealer penalty clauses, on their purchase order or contractually agreed to between the dealer and their clients are not binding on Randell. Randell does not accept orders subject to penalty clauses. This agreement supersedes any such clauses in dealer purchase orders.

EXPORT POLICY

All quotations for export sales will be handled by Unified Brands export agent. For inquiries on export equipment please contact our customer service team at 888-994-7636.

*FOOTNOTES IN REFERENCE TO PARAGRAPHS ABOVE

1. Herein called Randell.

2. NET means list price less discount, warranty, labor policy, freight, Randell delivery and other miscellaneous charges.

CASH DISCOUNTS WILL BE CALCULATED ON NET ONLY.

Unit Specifications



9900SCA / 9900SCN – COLD PAN

Model	12" X 20" Pan Capacity	L	W	Cutout Dim.		HP	Volt	Amp.	NEMA	Ship Wt.
				L	W					
9918SCA	1	17 1/2"	26"	16"	24 3/4"	1/4	115/60/1	5	5-15P	110
9928SCA	2	30 1/4"	26"	28 3/4"	24 3/4"	1/4	115/60/1	5	5-15P	140
9943SCA	3	43 3/8"	26"	41 7/8"	24 3/4"	1/4	115/60/1	5	5-15P	175
9957SCA	4	56 1/4"	26"	54 3/4"	24 3/4"	1/4	115/60/1	5	5-15P	210
9972SCA	5	69 1/4"	26"	67 3/4"	24 3/4"	1/4	115/60/1	5	5-15P	245
9986SCA	6	82 1/8"	26"	80 5/8"	24 3/4"	1/4	115/60/1	5	5-15P	280
9946SCN	2	46"	18 5/16"	44 1/2"	17"	1/4	115/60/1	5	5-15P	140
9966SCN	3	66 3/4"	18 5/16"	65 7/16"	17"	1/4	115/60/1	5	5-15P	175
9987SCN	4	87 1/2"	18 5/16"	86 3/16"	17"	1/4	115/60/1	5	5-15P	210

Unit Installation

SELECTING A LOCATION FOR YOUR NEW UNIT

The following conditions should be considered when selecting a location for your unit:

1. **Countertop Load:** The area on which the unit will rest must be level, free of vibration, and suitably strong enough to support the combined weights of the unit plus the maximum product load weight.
2. **Secure & Seal:** Once the drop in unit is installed into the counter it can be secured to the countertop by using the brackets supplied from the factory. See FIGURE 1 for drop in requirements. (page 12)
 - a. Locate square openings on exterior body of drop unit. Insert securing bracket as shown. Tighten screw to anchor the unit tightly to cabinet top.

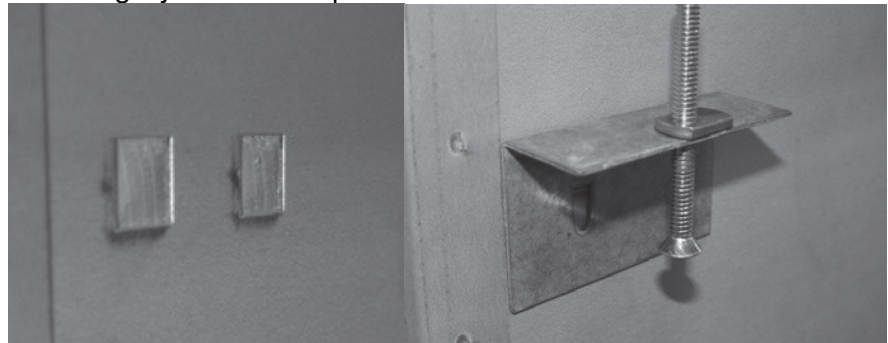

- b. Seal top flange to the countertop by using food grade silicone sealant.
3. **Ventilation (for mechanical cooled units):** The air cooled self contained unit requires a sufficient amount of cool clean air. The mechanical housing on all models (except 9918SCA) can be rotated so that the condenser intake air can be in direct line with the cabinet fresh air opening. See FIGURE 2 for rotation orientation (page 13)
 - a. Loosen wing nuts located under cold pan body and rotate carriage to desired location.
 - b. Tighten wing nuts when rotation is complete.
 - c. Loosen wing nuts on each side of condenser shroud and extend to fresh air opening.
 - d. Tighten wing nuts on each side of condenser shroud.

Unit Installation (con't)



Cross ventilation in the cabinet is recommended to maintain ambient temperature 86°F or less. Avoid surrounding your drop in with other heat generating equipment and keep out of direct sunlight. Also, avoid locating in an unheated room or where the room temperature may drop below 55° F or above 86°F. It is recommended that drop in be installed with the condenser coil facing a ventilated opening in the cabinet.

INSTALLATION CHECKLIST

After the final location has been determined, refer to the following checklist prior to start-up:

1. Follow cut out dimensions provided for specific models to properly size the opening for your drop in.

NOTE: It is recommended that drop in be installed with the condenser coil facing a ventilated opening in the cabinet

2. Check cord and plug of unit to assure no damage has occurred to these components.
3. Assure all refrigeration lines are clear of obstruction before, during, and after being installed into the counter.
4. Check all sheet metal surrounding the mechanical compartment to assure no damage has occurred in these areas.
5. Plug in unit and turn on main on/off power switch.
6. Allow unit time to cool down to temperature. A layer of frost will form and remain around the inside perimeter of the rail.
7. Refer to the front of this manual for serial number location. Please record this information in your manual on page 3 now. It will be necessary when ordering replacement parts or requesting warranty service.
8. Confirm that the unit is holding temperature. Set control to desired temperature for your particular ambient and altitude.

NOTE: FAILURE TO FOLLOW INSTALLATION GUIDELINES AND RECOMMENDATIONS MAY VOID THE WARRANTY ON YOUR UNIT.

ELECTRICAL SUPPLY: The wiring should be done by a qualified electrician in accordance with local electrical codes. A properly wired and grounded outlet will assure proper operation. Please consult the data tag attached to the compressor to ascertain the correct electrical requirements. Supply voltage and amperage requirements are located on the serial number tag located inside the mechanical housing.

NOTE: it is important that your unit has its own dedicated line. Condensing units are designed to operate with a voltage fluctuation of plus or minus 10% of the voltage indicated on the unit data tag. Burn out of a condensing unit due to exceeding voltage limits will void the warranty.

FIGURE-1

IMPORTANT

RECOMMENDED INSTALLATION INSTRUCTION FOR SELF-CONTAINED DROP-IN COLD PAN.

1: DETERMINE LOCATION OF AIR INTAKE AND EXHAUST OPTION **S** OR **R**

2: SECURE UNIT TO TOP WITH NSF APPROVED SILICON

3: INSTALL LOUVER (18"X22") MIN

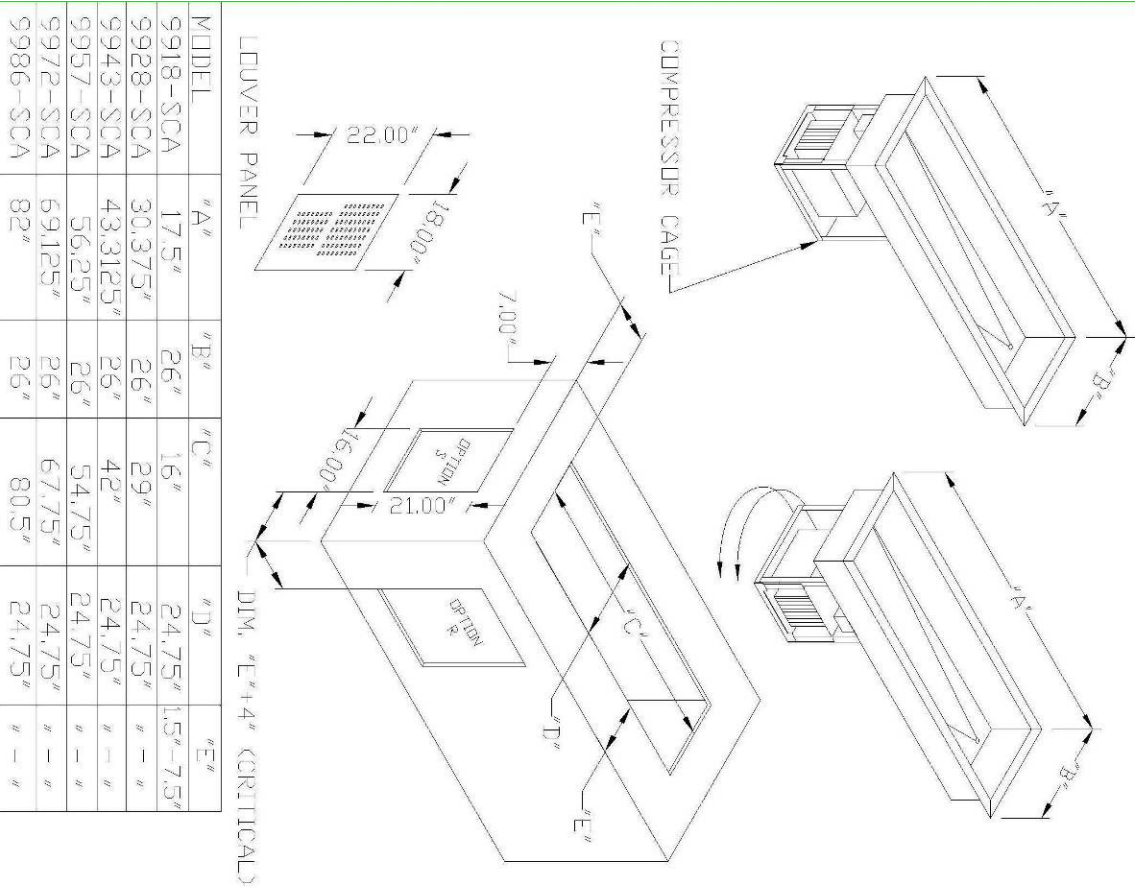
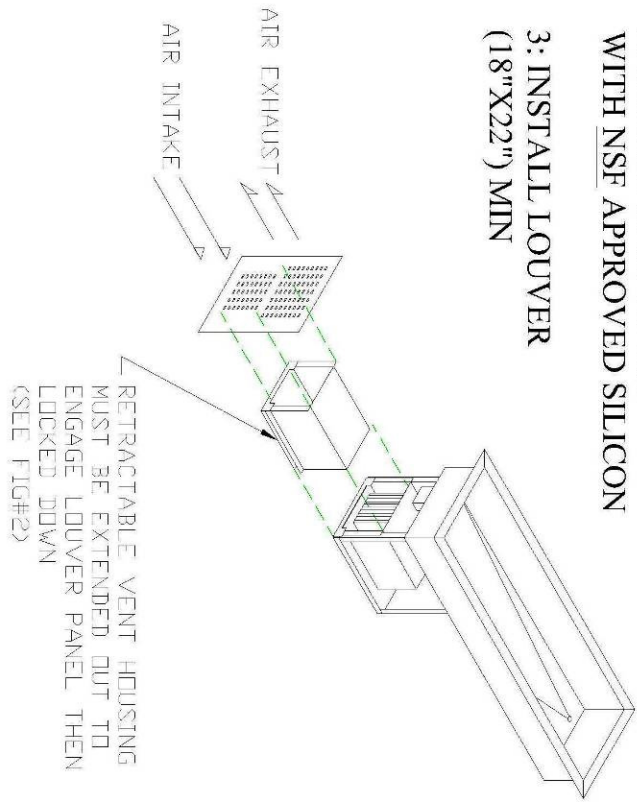

MODEL	#A"	#B"	#C"	#D"	#E"
9918-SCA	17.5"	26"	16"	24.75"	1.5"-7.5"
9928-SCA	30.375"	26"	29"	24.75"	" - "
9943-SCA	43.3125"	26"	42"	24.75"	" - "
9957-SCA	56.25"	26"	54.75"	24.75"	" - "
9972-SCA	69.125"	26"	67.75"	24.75"	" - "
9986-SCA	82"	26"	80.5"	24.75"	" - "

FIGURE-2

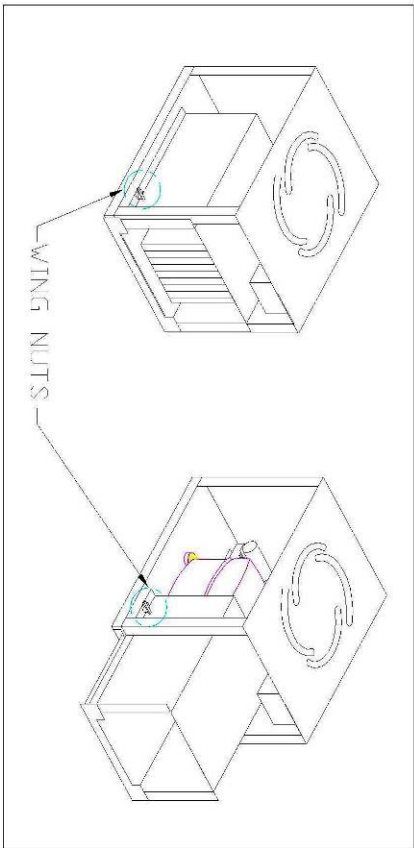
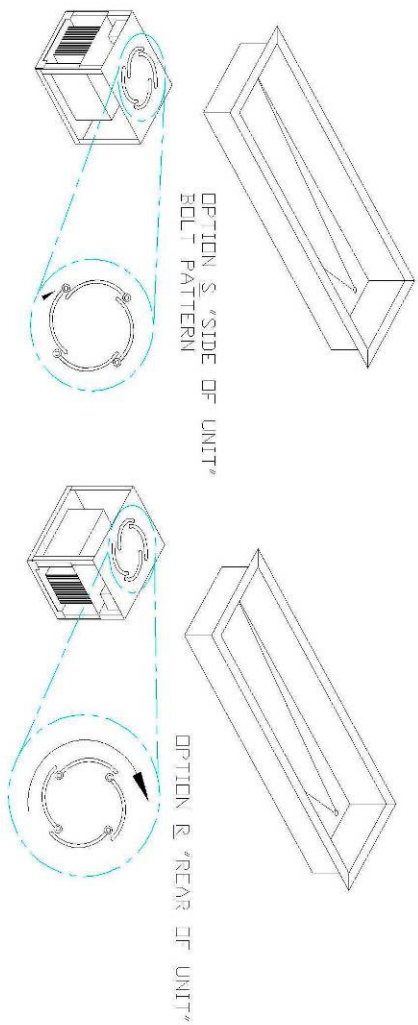

*TO ROTATE LOUVER 4 MOUNTING BOLTS ON TOP OF COMPRESSOR CAGE 1 1/2 TURNS THEN HOLD COMPRESSOR CAGE BY THE FRAME AND ROTATE 90° TO DESIRED POSITION RETIGHTEN BOLTS

*TO EXTEND VENT HOUSING REMOVE LOUVER AND LOOSEN WING NUTS LOCATED ON THE SIDE OF HOUSING. NOW EXTEND THE HOUSING UNTIL IT ENGAGES THE LOVERED OPENING. FINGER TIGHTEN WING NUTS, THEN REINSTALL LOUVER.

Unit Operation

Randell has preset the cold control to ensure that your unit runs at an optimum temperature, but due to varying ambient conditions, including elevation, food product as well as type of operation, you may need to alter this temperature. Additional adjustments can be made (within limits) by turning the control dial up or down until the desired temperature is reached. Please allow 24 hours between adjustments.

Your condiment pans will remain proper temperatures when utilized properly. For models provided with covers it is strongly recommended that the covers be kept in closed position when the unit is not in use and between rush periods. This is especially important in the summer months and in ambient conditions exceeding 86° F.

It is normal for the refrigerated cold well to develop an even layer of frost during operation.

Note: All individual condiment pans need to be in place for the cold well at all times during operation. If no product is available or necessary place empty pans into position.

Your refrigerated drop in is equipped with a temperature adjustment control (Figure 1 & Figure 2). This is found in the compressor compartment under the cold well.



Figure 1 illustrates the electrical control box inside the mechanical compartment. The thermostat adjustment knob for the refrigerated rail is located on the top portion of the control box.

MORNING STARTUP

1. Cold pan cleaning may be performed at this time.
2. Turn on cold pan with switch located on the front right corner of the mechanical compartment.
3. Allow 30 minutes for the cold pan to cool down before loading product.
4. Load the product and proceed with food preparation.

Note: Product entering the cold pan must be at 40°F or less.

Unit Operation (con't)

EVENING SHUT DOWN

1. Remove product from the cold pan at the end of the day's preparation. The product may be discarded or stored in any commercial refrigerator.
2. Turn off the cold pan with the switch located within the mechanical compartment.
3. Unit cleaning may be performed at this time once the frost has melted off the surface.

Preventive Maintenance

Randell strongly suggests a preventive maintenance program which would include the following **Monthly** procedures:

If a failure of the equipment is a direct result of any of the Preventative Maintenance guidelines being neglected the repairs will not be covered under warranty.

1. Cleaning of all condenser coils. Condenser coils are a critical component in the life of the compressor and must remain clean to assure proper air flow and heat transfer. Failure to maintain this heat transfer will affect unit performance and eventually destroy the compressor. Clean the condenser coils with coil cleaner and/or a vacuum, cleaner and brush.

1A. Use of any filter over the condenser coil may result in poor performance of the equipment. The factory does not recommend any auxiliary filter be used on the condenser coil. Any failures of the unit as a result of an auxiliary filter will not be covered under warranty.

NOTE: Brush coil in direction of fins, normally vertically as to not damage or restrict air from passing through condenser.

2. Clean fan blade on the condensing unit.

NOTE: DO NOT USE SHARP UTENSILS.

RECOMMENDED CLEANERS FOR YOUR STAINLESS STEEL INCLUDE THE FOLLOWING:

JOB	CLEANING AGENT	COMMENTS
Routine cleaning	Soap, ammonia, detergent Medallion	Apply with a sponge or cloth
Fingerprints and smears	Arcal 20, Lac-O-Nu, Ecoshine	Provides a barrier film
Stubborn stains and discoloration	Cameo, Talc, Zud, First Impression	Rub in the direction of the polish lines
Greasy and fatty acids, blood, burnt-on foods	Easy-Off, Degrease It, Oven Aid	Excellent removal on all finishes
Grease and Oil	Any good commercial detergent	Apply with a sponge or cloth
Restoration/Preservation	Benefit, Super Sheen	Good idea monthly

Reference: Nickel Development Institute, Diversey Lever, Savin, Ecolab, NAFEM.

NOTE: Do not use steel pads, wire brushes, scrapers, or chloride cleaners to clean your stainless steel.

CAUTION: DO NOT USE ABRASIVE CLEANING SOLVENTS, AND NEVER USE HYDROCHLORIC ACID (MURIATIC ACID) ON STAINLESS STEEL.

Proper maintenance of equipment is the ultimate necessity in preventing costly repairs. By evaluating each unit on a regular schedule, you can often catch and repair minor problems before they completely disable the unit and become burdensome on your entire operation.

For more information on preventive maintenance, consult the local ASA or CFESA member. Most repair companies offer this service at very reasonable rates to allow you the time you need to run your business along with the peace of mind that all your equipment will last throughout its expected life. These services often offer guarantees as well as the flexibility in scheduling or maintenance for your convenience.

For a complete listing of current Randell ASA please visit www.unifiedbrands.net

Unified Brands believes strongly in the products it manufactures and backs those products with one of the best warranties in the industry. We believe with the proper maintenance and use, you will realize a profitable return on your investment and years of satisfied service.

Electrical Diagram

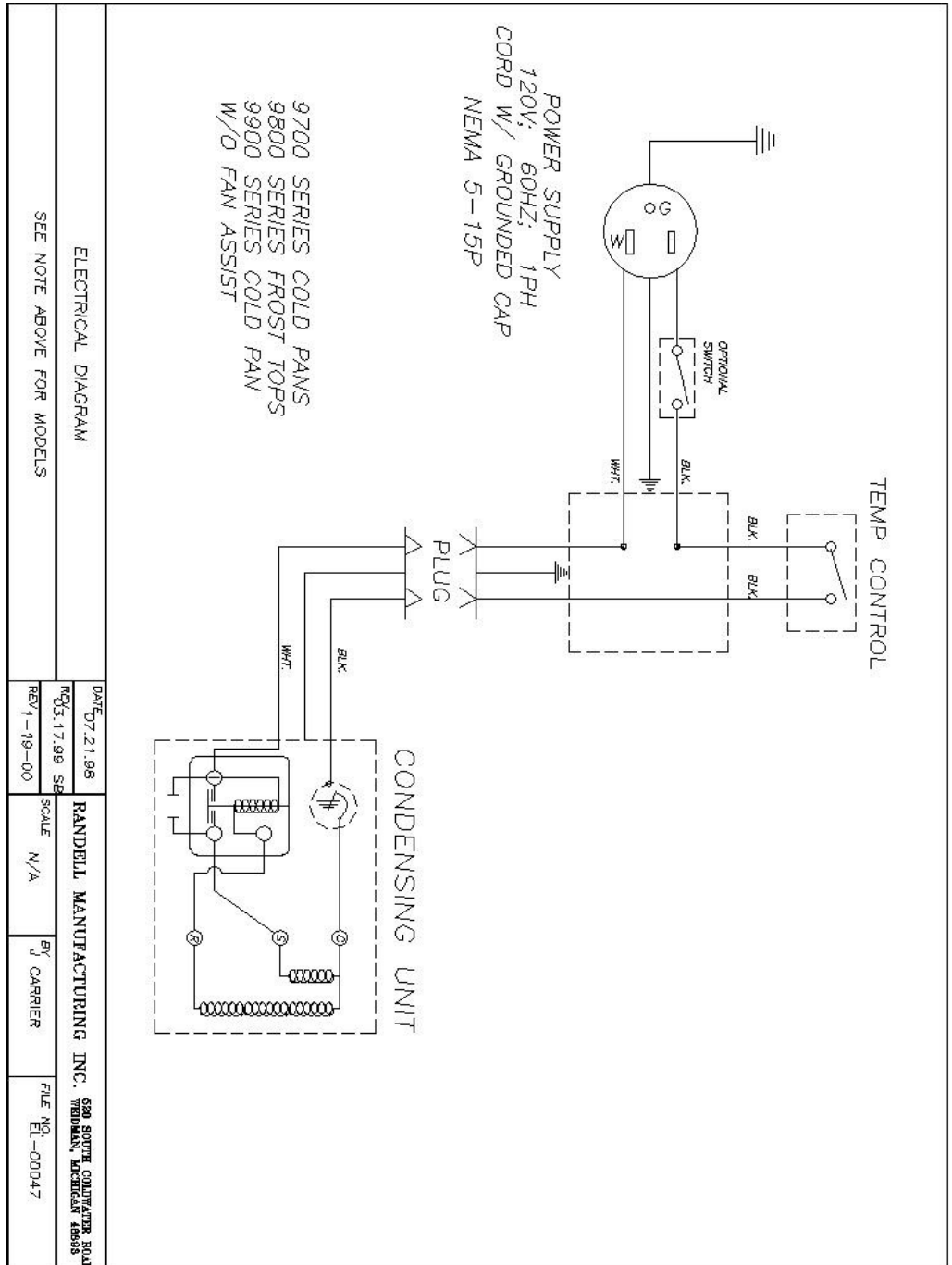

Trouble Shooting Guide

SYMPTOM	POSSIBLE CAUSE	PROCEDURE
Unit doesn't run	<ol style="list-style-type: none"> 1. No power to unit 2. Temperature control turned off 3. Temperature control faulty 4. Compressor overheated 5. Condenser fan faulty 6. Overload protector faulty 7. Compressor relay faulty 8. Compressor faulty 	<ol style="list-style-type: none"> 1. Plug in unit (check power switch) 2. Check temperature control 3. Test temperature control 4. Clean condenser coil 5. Service condenser fan 6. Test overload 7. Test relay 8. Call ASA for service
Unit short cycles	<ol style="list-style-type: none"> 1. Condenser coil dirty 2. Condenser fan faulty 3. Compressor faulty 4. Overload repeatedly tripping 	<ol style="list-style-type: none"> 1. Clean coil 2. Service fan and motor. 3. Call ASA for service 4. Check outlet voltage
Unit runs constantly	<ol style="list-style-type: none"> 1. Condenser coil dirty 2. Condenser fan faulty 3. Low on refrigerant 	<ol style="list-style-type: none"> 1. Clean coil 2. Service condenser motor 3. Call ASA for service
Unit too cold	<ol style="list-style-type: none"> 1. Temperature control set too low 2. Temperature control faulty 	<ol style="list-style-type: none"> 1. Adjust control to raise setting 2. Test control
Unit noisy	<ol style="list-style-type: none"> 1. Compressor mountings loose or hardened. 2. Condenser fan damaged or hitting fan shroud 	<ol style="list-style-type: none"> 1. Tighten or replace compressor mountings 2. Inspect condenser fan

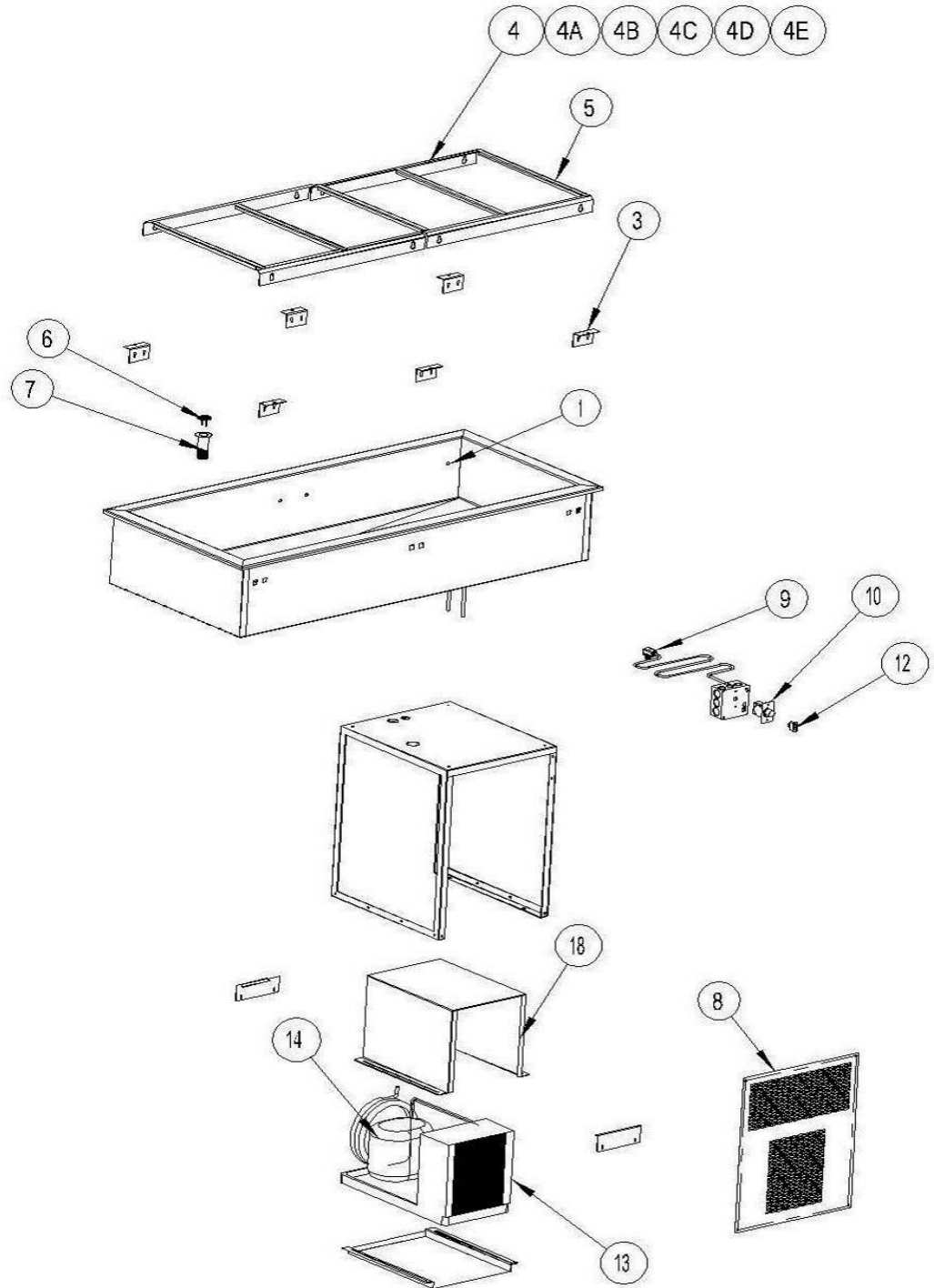

Replacement Parts

9900SCA Series

Item #	Part Number	Part Description
1	HD PIN001	PIN, KEY PAN RAIL 1/2DIAx1/4, 1/4-20x3/8SHNK
NS	PB VLV1000	DRAIN VALVE, 1" THREAD GATE* 100-005 (PFT300G)"
3	RP CLP0102	HOLD DOWN CLIP COLD PANS AND PLATE CHILLERS
4	RP BRK013	CLIPS, PAN RAIL 9918SCA
4a	RP BRK027	CLIPS, PAN RAIL 9928SCA
4b	RP BRK019	CLIPS, PAN RAIL 9943SCA
4c	RP BRK026	CLIPS, PAN RAIL 9957SCA
4d	RP BRK032	CLIPS, PAN RAIL 9972SCA
4e	RP BRK025	CLIPS, PAN RAIL 9986SCA
5	RP BAR0100	ADAPTER BAR, 20.5" X 7/8"
6	RP DSN001	DRAIN SCREEN
7	HD DRN100	DRAIN, 1" BRASS W/ LOCK NUT
8	RP LVR0019	LOUVER, FLAT 9900SCA SERIES
9	EL WIR461-90	POWER CORD, 9' 16/3 W/90* PLUG000461-RT (SJTO WIRE)
10	HD CNT9902	TEMPERATURE CONTROL
NS	EL WIR469A	12" FEMALE COND UNIT POWER CORD
12	EL SWT0502	SWITCH, ROCKER ON/OFF
13	RF CON0201	CONDS, 1/4 HP LT 404A 115V AEA2380ZXAGK 2X411-3
14	RF CMP0201P	COMPRESSOR, 1/4HP LO R-404A AEA2380ZXA
NS	RF FLT9902	FILTER DRYER, 1/4x.042 FILTER, EKP-032 SC DBL INLET
NS	RP CAP023	0.036 X 144" CAP TUBE" W/ DRIER
NS	RF ASY1200P	CONDENSER FAN MOTOR, BLADE, GUARD ASSY , 9WATT
18	RP DGH1300	CONDENSER DOG HOUSE
NS	NOT SHOWN	