

REPLACEMENT PARTS FOR PREEVA SERIES

INDOOR MODELS PDH, SDH, PEH, PXH, AND SHH
OUTDOOR MODELS RDH, REH, RXH, AND RHH



TABLE OF CONTENTS

MODEL APPLICABILITY	2
REFERENCES	3
SAMPLE RATING PLATES	3
SERIAL NUMBER DECODING	4
ELECTRICAL COMPONENTS	6
BLOWER MOTORS, CONTACTORS, AND STARTERS	24
VENTER COMPONENTS	28
VENT TERMINAL COMPONENTS	31
REPLACEMENT HEAT EXCHANGERS	35
FLUE COLLECTION BOX, BURNER SHIELD, AND CONDENSATE DRAIN ASSEMBLIES	36
BURNER COMPONENTS (MODELS PDH, SDH, RDH, SHH, AND RHH)	38
GAS CONVERSION KITS	39
BLOWER COMPONENTS	39
DRIVE COMPONENTS (PULLEYS AND BELTS)	41
COOLING COIL CABINET COMPONENTS	45
OPTION AR8: ON/OFF DAMPER WITHOUT MIXING BOX	55
INLET DUCT FLANGE, INLET SCREEN, AND REPLACEMENT FILTERS	56
OPTION AS2: INLET AIR HOOD COMPONENTS (MODELS RDH, RHH, RXH, AND REH)	57
MIXING BOX COMPONENTS	58
LOUVER ASSEMBLY COMPONENTS	62
DISCHARGE OPTION COMPONENTS	63
ROOF CURBS	68
CABINET COMPONENTS	74
OPTIONAL EVAPORATIVE COOLING MODULE COMPONENTS	87

IMPORTANT

1. Always include complete model and serial number so that any specification change can be considered for parts replacement. It can save time and expense.
2. In keeping with our policy of continuous product improvement, we reserve the right to alter any information shown here. Specifications are subject to change without notice.
3. We reserve the right to substitute functional replacements.
4. Order by Part Number (PN), not by option designation.

MODEL APPLICABILITY

This manual covers the following **indoor** models (see [Figure 1](#)):

- PDH: gas-fired heat, power-vented
- PEH: electric heat
- PXH: air handler
- SDH: gas-fired heat, separated-combustion
- SHH: gas-fired heat, high-efficiency, separated-combustion

This manual covers the following **outdoor** models (see [Figure 1](#)):

- RDH: gas-fired heat, power-vented (shown with outside air hood attached)
- REH: electric heat
- RHH: gas-fired heat, high-efficiency, power-vented (shown with outside air hood attached)
- RXH: air handler (shown with hood)










Indoor Models	Outdoor Models
 SDH	 RDH
 PDH	 REH
 PEH	 RXH
 PXH	 RHH
 SHH	

Figure 1. Applicable Models

REFERENCES

Table 1. Related Technical Manuals Available from Factory Distributor		
Type	Form	PN
Outdoor installation (models RDH, REH, RHH, and RXH)	I-RDH,REH,RHH,RXH	215210
Indoor installation (models PDH, SDH, SHH, PEH, and PXH)	I-PDH,SDH,PEH,SHH,PXH	211408
Operation (models PDH, SDH, PEH, SHH, PXH, RDH, RHH, REH, and RXH)	O-PREEVA	234661
Venting instructions (model PDH)	I-PDH-V	211409
Venting instructions (model SDH)	I-SDH-V	211410
Venting instructions (model SHH)	I-SHH-V	257037
Gas conversion (models RDH, PDH, SDH, SHH, and RHH)	CP-PREEVA-GC	212063
Replacement valves and ignition controls	P-VALVES	263995

*Also available at www.reznorhvac.com.

SAMPLE RATING PLATES

MERCER, PA. USA 16137

**SEPARATED COMBUSTION SYSTEM UNIT HEATER
FOR INDUSTRIAL/COMMERCIAL USE**

CATEGORY [S]

ANSI Z83.8 [A] CSA 2.6 [A'] UNIT HEATER

MODEL [B] [C]

SERIAL NO. [D] HP

[E] VOLTS [E] PH [E] HZ MAXIMUM TOTAL INPUT [E] AMPS

TYPE OF GAS: [F]

FOR USE AT [I] FEET, [I'] METERS OF ALTITUDE.

ORIFICE SIZE [L] DRILL

NORMAL INPUT	[N]	[X]	SEA LEVEL ALT. ADJUSTED BTU/HR
THERMAL OUTPUT CAPACITY	[P]	[Y]	BTU/HR
MINIMUM INPUT (2,2L,D2,DM,D2J,DMJ MODELS)	[Q]	[Z]	BTU/HR
NORMAL MANIFOLD PRESSURE	[G]	[AA]	IN. W.C.
MIN. PERMISSIBLE GAS SUPPLY PRESSURE FOR PURPOSE OF INPUT ADJUSTMENT.	[H]		IN.
TEMPERATURE RISE RANGE FROM [J] DEG. F. TO [K] DEG. F.			
MAXIMUM EXTERNAL STATIC PRESSURE [M]			IN. W.C.
EQUIPPED FOR OPERATION AT AN AIR FLOW OF [T]			SCFM
AGAINST A STATIC PRESSURE OF [U]			IN. W.C.
DRIVE NO. [V] WIRING DIAGRAM [W]			

CLEARANCES TO COMBUSTIBLE CONSTRUCTION: TOP-18 , FLUE
CONNECTION-18 , CONTROL SIDE-[R] , OPP. SIDE-18 , BOTTOM-0 , FRONT-48

FOR ALTERNATE INSTALLATIONS USE THE LATEST EDITIONS OF THE
APPROPRIATE STANDARD LISTED BELOW:

FOR AIRCRAFT HANGARS	USE STANDARD ANSIFPPA 409
FOR PARKING STRUCTURES	USE STANDARD ANSIFPPA 88A
FOR REPAIR GARAGES	USE STANDARD ANSIFPPA 88B

INSTALLATION OF THIS UNIT IN AIRCRAFT HANGERS IN ACCORDANCE WITH THE
REQUIREMENTS OF THE ENFORCING AUTHORITIES AND IN PUBLIC GARAGES IN
ACCORDANCE WITH THE CAN/CSA-B149 CODES.

THIS UNIT MAY BE INSTALLED DOWNSTREAM FROM A REFRIGERATION SYSTEM.
THIS UNIT MAY BE USED WITH DUCTS AND FILTERS.

CONSTRUCTION WALL THICKNESS FOR PURPOSE OF VENTING: 1 MIN., 48 MAX.

- A = ANSI standard date
- A' = CSA standard date
- B = Model No.
- C = Date of manufacture (month/year)
- D = Blower motor horsepower (option)
- E = Input amps
- F = Fuel type (natural gas or propane)
- G = Normal manifold pressure
- H = Minimum gas supply pressure
- I = Altitude (feet)
- I' = Altitude (meters)
- J = Minimum temperature rise (°F)
- K = Maximum temperature rise (°F)
- L = Orifice size
- M = Maximum external static
- N = Normal BTU_h input (sea level)
- P = Thermal output BTU_h (sea level)
- Q = Minimum BTU_h input (sea level)
- R = Control side clearance (inches)
- S = Category
- T = SCFM
- U = Static pressure
- V = Drive option designation (AM__)
- W = Wiring diagram No.
- X = Normal BTU_h input (adjusted for altitude)
- Y = Thermal output BTU_h (adjusted for altitude)
- Z = Minimum BTU_h input (adjusted for altitude)
- AA = Normal manifold pressure (IN WC, adjusted for altitude)

Figure 2. Sample Gas-Fired Model Heat Section Rating Plate and Key

MERCER, PA., U.S.A. 16137			
MADE IN USA			
UNIT HEATER FOR INDUSTRIAL/COMMERCIAL USE			
MODEL	[B]		
SERIAL NO.	[]		
ELECTRICAL			
[E] VOLTS +/- 10%	[E] HZ		
MINIMUM CIRCUIT AMPACITY (MCA)	[AH]	AMPS	
MAXIMUM FUSE SIZE/CKT BREAKER	[AI]	AMPS	
FUSIBLE MAX./DISJONCTEUR MAX.	[AI]	AMPS	
	QTY	FLA (EA)	HP (EA)
SUPPLY AIR BLOWER MOTOR	1	[AJ]	[D]
	QTY	RLA (EA)	LRA (EA)
COMPRESSOR A	[AD]	[AE]	[AF]
CIRCUITS A			
REFRIGERANT - R-410a	CHARGE - LBS	[AG]	
TEST PRESSURES - HIGH	600PSIG	LOW	112PSIG
REFER TO RATING PLATE IN THE FURNACE SECTION (WHEN USED) FOR ADDITIONAL INFORMATION.			
*HACR TYPE REQUIRED PER NEC			

- B = Model No.
- D = Blower motor horsepower (option)
- E = Input amps
- AD = Compressor quantity
- AE = Compressor RLA
- AF = Compressor LRA
- AG = Compressor refrigerant charge
- AH = MCA
- AI = Maximum fuse size
- AJ = Blower motor FLA

Figure 3. Sample Optional Reheat Rating Plate and Key

MERCER, PA. USA 16137			
MADE IN USA			
UNIT HEATER FOR INDUSTRIAL/COMMERCIAL USE			
MODEL	[A]	[B]	
SERIAL NO.	[]	[]	
[C] VOLTS +/- 10%	[C] PH	[C]	HZ
MINIMUM CIRCUIT AMPACITY (MCA)	[D]	AMPS	
MAXIMUM FUSE SIZE/CKT BREAKER	[E]	AMPS	
*HACR TYPE REQUIRED PER NEC			
NORMAL INPUT [F] KW			
	QTY	FLA	HP
SUPPLY AIR BLOWER MOTOR	1	[G]	[H]
TEMPERATURE RISE RANGE FROM 20 DEG. F. TO 75 DEG. F.			
MAXIMUM EXTERNAL STATIC PRESSURE 3.0 IN. W.C.			
EQUIPPED FOR OPERATION AT AN AIR FLOW OF [I] SCFM			
AGAINST A STATIC PRESSURE OF [J] IN. W.C.			
DRIVE NO. [K]	WIRING DIAGRAM [L]		
CLEARANCES TO COMBUSTIBLE CONSTRUCTION: TOP-6 ,			
CONTROL SIDE-20 , OPP. SIDE-6 , BOTTOM-0			
	QTY	RLA (EA)	LRA
COMPRESSOR	1	[N]	[O]
REFRIGERANT - R-410A CHARGE - [P] LBS			
TEST PRESSURES - HIGH 600 PSIG, LOW 112 PSIG			

- A = Model No.
- B = Date of manufacture (month/year)
- C = Supply voltage
- D = MCA
- E = Maximum fuse size
- F = kW
- G = Blower motor FLA
- H = Blower motor HP
- I = SCFM
- J = Static pressure
- K = Drive option designation (AM__)
- L = Wiring diagram No.
- N = AU7 compressor RLA
- O = AU7 compressor LRA
- P = Compressor refrigerant charge

Figure 4. Sample Electric Model with Optional Reheat Rating Plate and Key

SERIAL NUMBER DECODING

Table 2. Serial Number Date Codes (Month and Year)

Year	Month											
	JAN	FEB	MAR	APR	MAY	JUN	JUL	AUG	SEP	OCT	NOV	DEC
2005	BEA	BEB	BEC	BED	BEE	BEF	BEG	BEH	BEI	BEJ	BEK	BEL
2006	BFA	BFB	BFC	bfd	BFE	BFF	BFG	BFH	BFI	BFJ	BFK	BFL
2007	BGA	BGB	BGC	BGD	BGE	BGF	BGG	BGH	BGI	BGJ	BGK	BGL
2008	BHA	BHB	BHC	BHD	BHE	BHF	BHG	BHH	BHI	BHJ	BHK	BHL
2009	BIA	BIB	BIC	BID	BIE	BIF	BIG	BIH	BII	BIJ	BIK	BIL
2010	BJA	BJB	BJC	BJD	BJE	BJF	BJG	BJH	BJI	BJJ	BJK	BJL
2011	BKA	BKB	BKC	BKD	BKE	BKF	BKG	BKH	BKI	BKJ	BKK	BKL
2012	BLA	BLB	BLC	BLD	BLE	BLF	BLG	BLH	BLI	BLJ	BLK	BLL
2013	BMA	BMB	BMC	BMD	BME	BMF	BMG	BMH	BMI	BMJ	BMK	BML
2014	BNA	BNB	BNC	BND	BNE	BNF	BNG	BNH	BNI	BNJ	BNK	BNL
2015	BOA	BOB	BOC	BOD	BOE	BOF	BOG	BOH	BOI	BOJ	BOK	BOL
2016	BPA	BPB	BPC	BPD	BPE	BPF	BPG	BPH	BPI	BPJ	BPK	BPL
2017	BQA	BQB	BQC	BQD	BQE	BQF	BQG	BQH	BQI	BQJ	BQK	BQL
2018	BRA	BRB	BRC	BRD	BRE	BRF	BRG	BRH	BRI	BRJ	BRK	BRL
2019	BSA	BSB	BSC	BSD	BSE	BSF	BSG	BSH	BSI	BSJ	BSK	BSL
2020	BTA	BTB	BTC	BTD	BTE	BTF	BTG	BTH	BTI	BTJ	BTK	BTL
2021	BUA	BUB	BUC	BUD	BUE	BUF	BUG	BUH	BUI	BUJ	BUK	BUL
2022	BVA	BVB	BVC	BVD	BVE	BVF	BVG	BVH	BVI	BVJ	BVK	BVL
2023	BWA	BWB	BWC	BWD	BWE	BWF	BWG	BWH	BWI	BWJ	BWK	BWL
2024	BXA	BXB	BXC	BXD	BXE	BXF	BXG	BXH	BXI	BXJ	BXK	BXL
2025	BYA	BYB	BYC	BYD	BYE	BYF	BYG	BYH	BYI	BYJ	BYK	BYL

ALL MODELS MANUFACTURED AFTER JUN 2015

Serial No. Sample: BOF 3060 000000

Elements: 1 | 2 | 3

- Key:** 1 = Date of manufacture (refer to [Table 2](#))
2 = Plant of manufacture (3060 = Mercer; 3062 = Monterrey)
3 = Consecutive number

GAS-FIRED MODELS MANUFACTURED BEFORE JUL 2015

Serial No. Sample: BHD 78 Y8 N 00000

Elements: 1 | 2 | 3 | 4 | 5

- Key:** 1 = Date of manufacture (refer to [Table 2](#))
2 = Ignition code (refer to P-Valves manual listed in [Table 1](#))
3 = Valve code (refer to P-Valves manual listed in [Table 1](#))
4 - Type of heat energy (N = natural gas; L = propane)
5 = Consecutive number

- Prefix:** E = E3 (409) stainless steel heat exchanger
S = 316 stainless steel heat exchanger

ELECTRIC HEAT MODELS MANUFACTURED BEFORE JUL 2015

Serial No. Sample: BHD D12D E 00000

Elements: 1 | 2 | 3 | 4

- Key:** 1 = Date of manufacture (refer to [Table 2](#))
2 = Ignition code (D12D, D12E, EG1M, EG2M)
3 - Type of heat energy (E = electric)
4 = Consecutive number

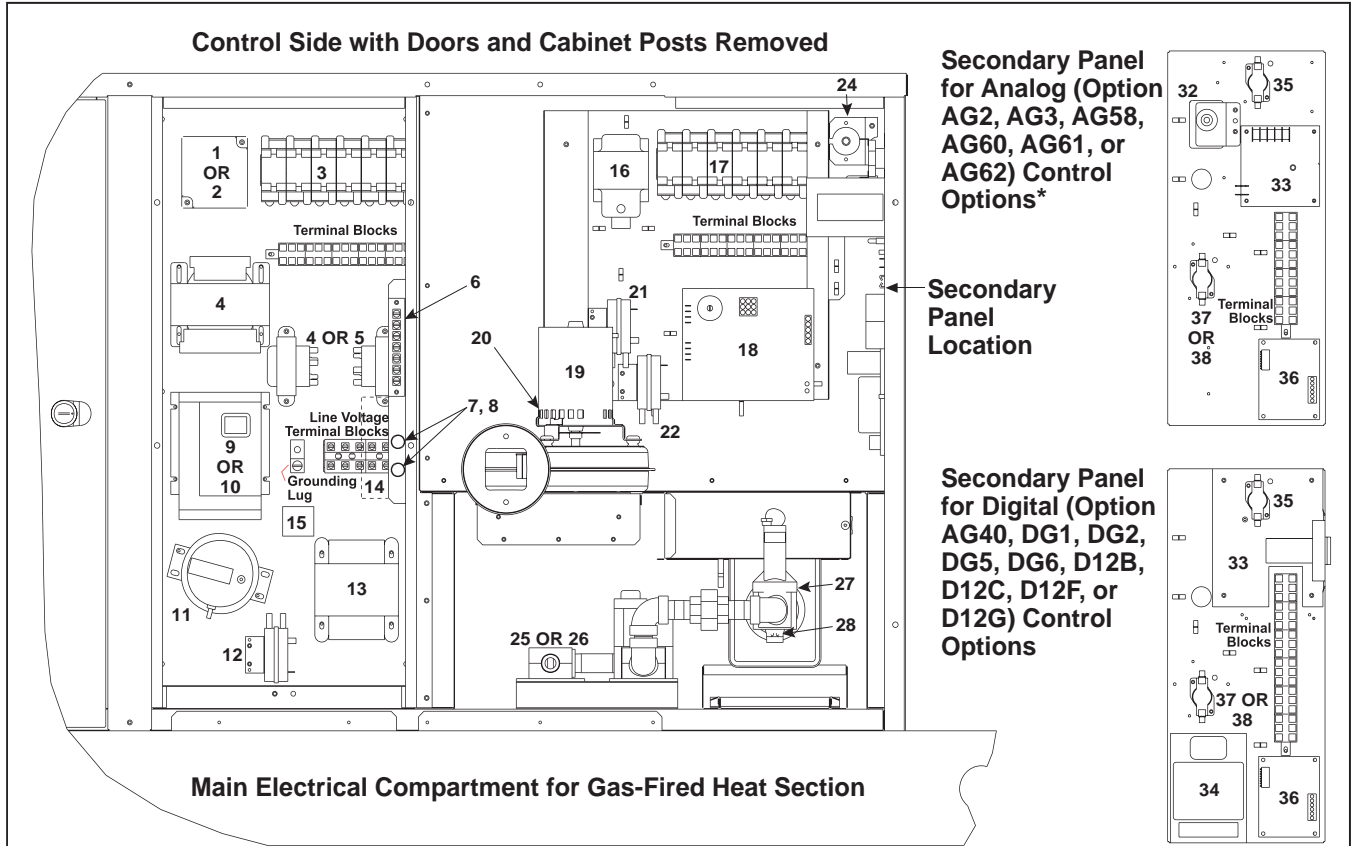
AIR HANDLER MODELS MANUFACTURED BEFORE JUL 2015

Serial No. Sample: BHD 00000

Elements: 1 | 2

- Key:** 1 = Date of manufacture (refer to [Table 2](#))
2 = Consecutive number

ELECTRICAL COMPONENTS



*Also on units manufactured before NOV 2006 with option AG2, AG15, or AG16

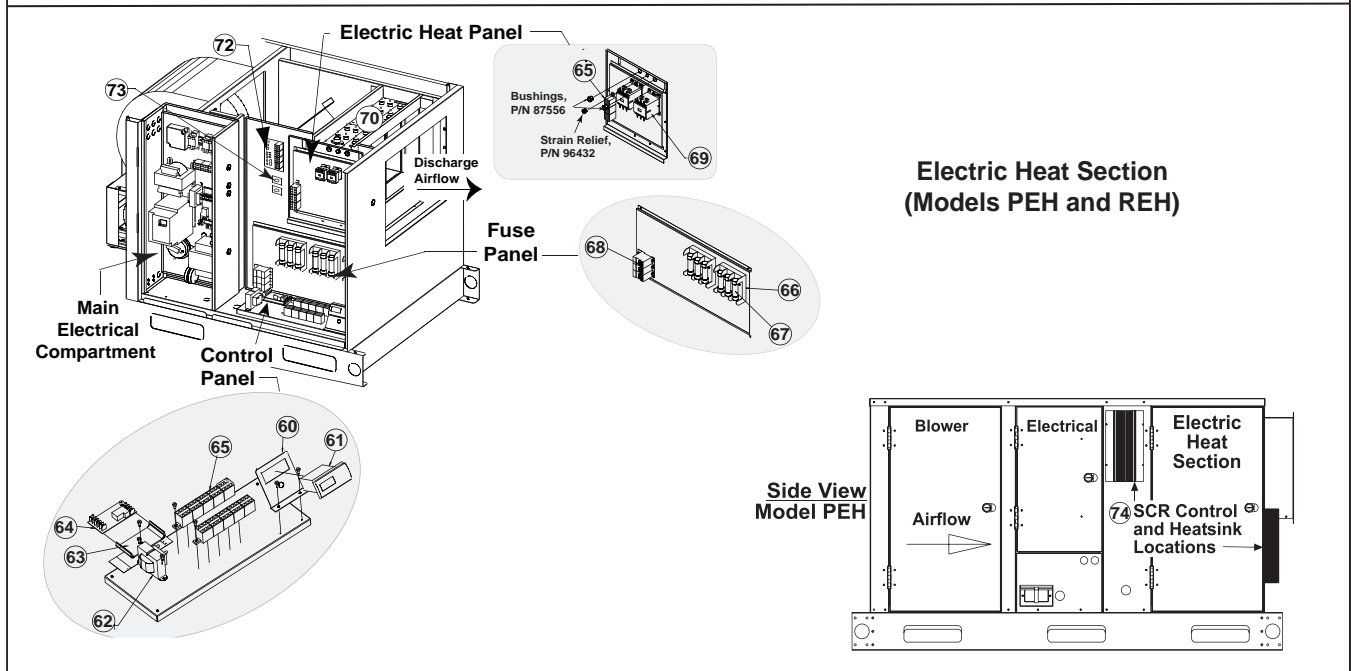


Figure 5. Electrical Component Locations (Refer to Table 3)

Table 3. Electrical Components

Item No.	Component	Models PDH, SDH, and RDH	Unit Size	Figure Reference
			75, 100, 125, 150, 175, 200, 225, 250, 300, 350, 400A	
		Models PXH and RXH	000A, 000B, 000C, 000D, 000E	
		Models SHH and RHH	130C, 180C, 260D, 350E	
		Models PEH and REH	10A, 20A, 40A, 15B, 30B, 60B, 30D, 60D, 90D, 120D, 40E, 80E, 120E	
Description		PN		
Electrical Components in Left Electrical Compartment (High and Low Voltage)				
1	Control	Phase loss, auto reset, 3PH (option BF15, ICM 401)	206105	Figure 5, Figure 6
2		Phase loss and over/under voltage, auto reset, 201A, 3PH (option BF14)	176826	
2A	Socket	For phase loss and over/under voltage control	194168	—
3	Plug-in relay	Omron, 3PDT, 24VAC	211799	Figure 5, Figure 6
		DPDT (LY2-AC24)	211411	
		DPDT (LY2-AC110/120)	211412	
		DPDT (LY2-AC200/220)	211413	
		DPDT (LY2-AC220/240)	211414	
3A	Socket	For DPDT plug-in relays	211415	
4	Transformer	40 VA, 115 volts in, 24 volts out, 1PH*	194808	Figure 5, Figure 6
		40 VA, 208/230V volts in, 24 volts out, 1PH and 208/3PH**	194536	
		40 VA, 230V/3PH	194536	
		40 VA, 460V	202661	
		275 VA, 575V***	105202	
5	Transformer	For programmable controller, 40 VA, 208/230V–24V (digital control options DG1, DG2, DG5, DG6, D12B, D12C, D12D, D12E, D12F, D12G)	194536	Figure 5, Figure 6
		For signal conditioner, 40 VA, 208/230V–24V (digital control options DG5, DG6, D12B)	194536	
		Secondary, 40 VA, 115V, 24V (options AG15 and AG16)	194808	
		40 VA, 208/230V–24V, 208/230/460/575	194536	
6	Terminal board for thermostat	Models with analog (option AG) controls only (#5959-7)	164545	
7	Fuse, 2-1/2A	For option DG, models PDH, SDH, and RDH only (#Mdq 2-1/2)	193803	Figure 5
8	Fuseholder		60241	
9	Control, Variable	Drive and matching line reactor (option VFD)	Refer to Table 4	Figure 5, Figure 6
9A	Frequency Drive (VFD)	Replacement display, ABB model ACS-CP-A	272508	
10	Motor starter	Refer to Blower Motors, Contactors, and Starters section		Figure 5
11	Dirty filter switch	Field-adjustable range of 0.17–5.00 (±0.05) IN WC (remote console option, Tridelta AP4434)	105507	Figure 5, Figure 6
12	Pressure switch	Air proving, 0.10 IN WC	234712	
13	Transformer	350 VA, 460V/3PH	257032	
		350 VA, 575V/3PH	257031	
14	Relay for reheat	For reheat options AU7 and AU8	234656	
15	Contactors	Compressor, 25A, 24V coil, for reheat options AU7 and AU8	216386	
*For optional evaporative cooling module (located either in main electrical compartment or in the cooling module control box).				
**Located in the cooling module control box.				
***Plus 115/24V, 40 VA transformer (PN 194808) in the cooling module box.				

ELECTRICAL COMPONENTS—CONTINUED

Table 3. Electrical Components—Continued								
Item No.	Component	Models PDH, SDH, and RDH	Unit Size				Figure Reference	
			75, 100, 125, 150	175, 200, 225	250, 300	350, 400A		
			Models SHH and RHH	—	130, 180	260		350
Description		PN						
Electrical Components in Primary Panel in Gas-Fired Heat Section Electrical Compartment (Low Voltage)								
16	Motor transformer	Control and damper, 75 VA, 120/208/240/480 volts in, 24 volts out	208989				Figure 5	
17	Relay, plug-in	Omron, 3PDT, 24VAC	211799				Figure 5, Figure 6	
17A	Socket	For 3PDT plug-in relay	211800					
18	Direct Spark Ignition (DSI) integrated control module*	For models PDH, SDH, SHH, RDH, and RHH with all gas control options except AG58 or D12G (serial No. code 78)	195573					
		For models SHH and RHH with gas control option AG58 or D12G (Varidigm VB1200-5-RZNR-SHH, serial No. code 99)	260917					
		For model RDH with gas control option AG58 or D12G (Varidigm VB1200-2-RZNR-PVA, serial No. code 98)	260252					
18A	ID plug	For DSI integrated control module (PN 260252 or 260917)	Refer to Table 5					
18B	Fuse	For DSI integrated control module (PN 195573)	201685				Figure 5	
19	Venter motor	Refer to Table 18				Figure 5, Figure 6		
20	Venter motor capacitor							
21	Pressure switch	Combustion air, high speed	Refer to Table 6				Figure 6	
22		Combustion air, low speed						
23		Condensate (model SHH only)	—	234712				
24	High temperature limit control, auto reset, with capillary	190°F/150°F, yellow dot (models PDH, SDH, and RDH only)	210854	—			Figure 5, Figure 6	
		240°F/210°F, green dot (models PDH, SDH, and RDH only)	—	210855	—			
		300°F/260°F, red dot (models PDH, SDH, and RDH only)	—		211066			
		No dot (models SHH and RHH only)	—		148588	—		
		240°F/210°F, green dot (models SHH and RHH only)	—	210855	—	210855		
Item No.	Component	Models PDH, SDH, and RDH	Unit Size				Figure Reference	
			75, 100, 125, 150	175, 200	225 250, 300, 350, 400A			
			Models SHH and RHH	—	130, 180	260, 350		
Description		PN						
Manifold Arrangement								
25	Single-stage gas valve**	Replacement valves are identified by serial No. code (refer to Serial Number Decoding section)	Refer to technical manual P-VALVES listed in Table 1				Figure 5, Figure 6	
26	Two-stage gas valve							
27	Modulating gas valve	Option AG8, AG9, AG9H, DG2, DG6, D12B, or AG40	Refer to Table 7					
28	Gas pressure switch (for modulation gas controls: option AG8, AG9, AG9H, DG2, DG6, D12B, or AG40)	Natural gas, 1.7 IN WC	211130					
		Propane, 5.0 IN WC	211710					
29	Ball valve actuator	8:1 turndown, natural gas or propane (option AG58 or D12G) (models RDH, SHH, and RHH only)	222862				Figure 7	
30	Ball valve		—	255786	258321			
31	Pressure transducer		8:1 turndown, natural gas (option AG58 or D12G)	257001				
		8:1 turndown, propane (option AG58 or D12G)	258725					
*For makeup air applications, adjust the blower off delay DIP switches on the module to 45 seconds. Refer to the table on the module for the DIP switch setting instructions.								
**Refer to heater installation manual listed in Table 1 (PN 215210 or 211408) for altitude adjustment.								

Table 3. Electrical Components—Continued

Item No.	Component	Models PDH, SDH, and RDH Description	Unit Size	Figure Reference	
			75, 100, 125, 150, 175, 200, 225 250, 300, 350, 400A		
			PN		
Analog Heating Controls in Secondary Panel in Gas Heat Section Electrical Compartment (Low Voltage)					
32	Ductstat	Unit-mounted (option AG3 or AG60)	211481	Figure 5, Figure 7	
33	Freezestat	Digital, with 10-foot sensor (option BE2)	211480		
Analog and Digital Heating Controls in Secondary Panel in Gas Heat Section Electrical Compartment (Low Voltage)					
34	Signal conditioner	Used in option DG2, DG6, or D12B	134170	Figure 5, Figure 7	
35	Time delay relay	Analog option AG8, AG9, AG9H, AG60, AG61, or AG62 and digital option DG1, DG2, DG5, DG6, AG40, D12, D12B, or D12C	121884		
36	Venter speed controller	Depending on date of manufacture, may use item 37 for venter speed change (analog option AG8, AG9, AG9H, AG60, AG61, or AG62 and digital option DG1, DG2, DG5, DG6, AG40, D12B, or D12C)	Refer to Table 8		
37	Electronic filter	Analog option AG8, AG9, AG9H, AG60, AG61, or AG62 and digital option DG1, DG2, DG5, DG6, AG40, D12B, or D12C	171738		
38	Time delay relay	Analog option AG8, AG9, AG9H, AG60, AG61, or AG62 and digital option DG1, DG2, DG5, DG6, AG40, D12B, or D12C	174810		
Item No.	Component	Models PDH, SDH, and RDH	Unit Size	Figure Reference	
		Models SHH and RHH	All Sizes (Applicable Options)		
		Models PXH and RXH			
		Description			PN
Digital Heating/Cooling Controls in Secondary Panel in Gas Heat Section Electrical Compartment (Low Voltage) for Models PDH, SDH, SHH, RHH, and RDH) or in Main Electrical Compartment for Models PXH and RXH					
39	FX05 digital controller (packaged assembly includes controller and software)	For option DG1	213635	Figure 7	
		For option DG2	213636		
		For option DG5	213637		
		For option DG6	213638		
		FX06 digital controller (packaged assembly includes controller and software)*	For option D12B		223485
			For option D12C		223486
			For option D12F		257432
For option D12G	260087				
40	Carel digital controller	For option D19	1011004	—	
		For option D21	1011005		
		For option D22	1013643		
		For option D23	1024324		
40A	Carel plug		1005719		
41	BACnet card, programmed (option BHB8)	For option D19	1005939	—	
		For option D21	1005940		
		For option D22	1013635		
		For option D23	1024323		
42	BACnet IP card, programmed	For option D19	1012847	—	
		For option D21	1012848		
		For option D22	1013651		
		For option D23	1024322		
43	Bus, communication (includes shipped-loose ferrite core for communication connection)	LON DDC, programmed (option BHB7 with D19)	1005937	—	
		LON DDC, programmed (option BHB7 with D21)	1005938		
44	Remote display, used only with option D19, D21, D22, or D23	For option RB5, includes hand-held display (PN 260178), 6-pin connection cable (PN 260175), and cable splitter and signal booster module (PN 260735)	260436	—	
		For option RB6, includes hand-held display (PN 260178) and 6-pin connection cable (PN 260175)	272407		
45	FX07 digital controller	With D12B software, special	262460		
46	Reheat valve interface board	Sporlan, for control systems other than D19,D21, D22, and D23	220843		
47	Reheat valve interface board airstream sensor	Sporlan, for control systems other than D19,D21, D22, and D23	220844		
48	Reheat valve	Sporlan	234062		
49	Reheat valve interface board	Sporlan, for D19, D21, D22, and D23 control systems	1024661		

ELECTRICAL COMPONENTS—CONTINUED

Table 3. Electrical Components—Continued

*Replacing FX06 controller on units manufactured **before** 20 DEC 2012 (date code BLL) requires a new wiring harness (PN 270294).

Item No.	Component	Models PDH, SDH, and RDH	Unit Size	Figure Reference
		Models SHH and RHH	All Sizes (Applicable Options)	
		Models PXH and RXH		
		Description	PN	
Digital Heating/Cooling Controls in Secondary Panel in Gas Heat Section Electrical Compartment (Low Voltage) for Models PDH, SDH, SHH, RHH, and RDH) or in Main Electrical Compartment for Models PXH and RXH—Continued				
50	Plug-in card for FX05 digital controller	7-day/24-hour time clock function (option BHB1 for option DG1, DG2, DG5, or DG6)	206076	Figure 7
		N2 open communication for J/C interface (option BHB2 for option DG1, DG2, DG5, or DG6)	206077	
	Plug-in card for FX05 digital controller, LONMARK open protocol interface (option BHB3)	For option DG1	223415	
		For option DG2	223416	
		For option DG5	223417	
		For option DG6	223418	
	Plug-in card for FX06 digital controller	N2 open communication for J/C interface (option BHB2 for option D12B, D12C, D12F, or D12G)	222054	
	Plug-in card for FX05 digital controller, LONMARK open protocol interface (option BHB3)	For option D12B	258237	
		For option D12C	258238	
		For option D12D	258239	
For option D12E		258240		
51	Pressure transducer	Option VFC3, with pressure sensing probe (PN 234821)	234818	
		Options VFC4 and GF5, with ceiling mount box (PN 234905) and outside pressure pickup port (PN 234906)	234819	
52	Pressure sensing probe	For pressure transducer (item 51)	234821 1020907	
53	Sensor	Outside air temperature and humidity, in outside air inlet	222754*	
54		Discharge air temperature, in discharge ductwork, with box and 8-inch probe	222753*	
55		Space temperature (option CL23)	257338	
		Space temperature (option CL33)	221038	
56		Space temperature (option CL78)	272631*	
		Building CO2 (option BE15)	256975	
		Averaging (mixed air/cooling coil) temperature, 18-inch	271993	
57		Averaging, zone temperature/humidity	235976*	
58	Outside or discharge air, for item 39 (JC A99hj-200d)	206112		
59				
60	Sensor mixing tube holder	Discharge sensor, with electrical box and cover, used with louvers and ductwork (used with option AG3, AG15, AG16, AG40, AG60, AG61, AG62, DG5, DG6, D12B, D12C, D12F, or D12G) (see Figure 34 for installation with louvers)	115850	Figure 7
60A	Bracket	Required on indoor unit with optional louvers	213612	—
Item No.	Component	Models PEH and REH	All Unit Sizes	Figure Reference
		Description	PN	
Electrical Components in Electric Heat Section Electrical Compartment				
61	Bracket	Controller	206139	Figure 5
62	FX06 digital controller**	With option D12D software	234685	
		With option D12E software	234686	
63	Plug-in card for FX06 digital controller with software for either option D12D or D12E	N2 open communication for J/C interface (option BHB2 for FX06 used in option D12E)	222054	
		N2 open communication for J/C interface (option BHB2 for FX06 used in option D12D)	222054	
		LONMARK open protocol interface (option BHB3 for FX06 used in option D12E)	258239	
		LONMARK open protocol interface (option BHB3 for FX06 used in option D12D)	258240	
64	Transformer	40 VA, 115 volts in, 24 volts out	194808	
		40 VA, 208/230 volts in, 24 volts out	194536	
		75 VA, 120/208/240/480 volts in, 24 volts out	208989	
		200 VA, 460/575 volts in, 230 volts out	210862	
		350 VA, 460/575 volts in, 230 volts out	210863	

*Used only with option D19, D21, D22, or D23.

Replacing FX06 controller on units manufactured **before 20 DEC 2012 (date code BLL) requires a new wiring harness (PN 270294).

Table 3. Electrical Components—Continued

Item No.	Component	Models PEH and REH	All Unit Sizes		Figure Reference
		Description	PN		
Electrical Components in Electric Heat Section Electrical Compartment—Continued					
65	Relay-mounting track	With reheat/dehumidification only		234816	Figure 5
66	Relay	With reheat/dehumidification only (RIB ME2401B)		234656	Figure 5, Figure 7
67	Terminal block	24V		144972	Figure 5
68	Fuse block			Refer to Table 9 and Table 10	Figure 5, Figure 7
69	Fuse				
70	Distribution block			207641	Figure 5
71	Contactor	PN 216386 replaces 19625		Refer to Table 9 and Table 10	Figure 5, Figure 7
		PN 216388 replaces 208375			
72	Heating element assembly	Electric			
73	Limit control	Electric heating element, 3/4-inch disc, 140°F/100°F, auto, white (60TX11-313124)		254754	Figure 7, Figure 8
74	Step controller	Used in some option D12D controls		Refer to Table 9 and Table 10	Figure 5, Figure 8
75	Transformer	Refer to PNs listed by voltage above for item 66			Figure 5, Figure 7
76	SCR power controller	With heatsink in option D12D (on cabinet side, front, or both)		Refer to Table 9 and Table 10	Figure 5, Figure 8
Item No.	Component	Description	Model(s)	PN	Figure Reference
Miscellaneous Electrical Components					
77	Reverse flow limit switch	In blower cabinet (unit sizes 75–150)		PDH, SDH, RDH, SHH, RHH	211754
		On heat section wall above electrical compartment (unit sizes 175–400)			
78	Convenience outlet	GFI outlet, requires its own electrical supply (option BC)		All	96912
		Outlet cover, requires its own electrical supply (option BC)			209010
79	Lockable service switch (option BA6)	60-amp, all except 208/1 and 230/1 with DH (reheat)		PDH, SDH, RDH, RHH	205906
		80-amp, 208/1 and 230/1 with DH (reheat)		PDH, SDH, RDH	205907
		—		SHH	205906
		—		PEH, REH	Refer to Table 11
80	Safety door switch	In control compartment		SDH, SHH	217262
		On blower door of any unit with option UV2 (germicidal lamps)		Any unit with option UV2	
81	Two-position switch	DPST (option AG3, AG8, AG9, AG15, AG16, AG61, AG62, or AG9H)		All	101902
82	Firestat	Option BD4 mounted in mixing box			42782
		Option BD5 field-installed in discharge duct			126170
83	Ductstat/high ambient limit control	Heat cutoff, adjustable 0–100°F (option AG8, AG9, AG9H, or BN2)			
84	Ductstat control	Option AG15, AG16, AG61, or AG62 (J/C A350)			115848
85	Ductstat stage adder	Option AG15, AG16, AG61, or AG62 (J/C S350)			115849
86	Digital display module	Option AG16 or AG62 (J/C D350)		PDH, SDH, RDH, SHH, RHH	115852
87	Sensor	For item 65, sensor holder is item 40 above (#A99BC-25C)			115851
88	Duct smoke detector	In supply duct (option SA1)			159553
88A	Sampling tube				259069
89	Discharge sensor	For modulating gas valve, Maxitrol TS-121 (options AG8 or AG9)		PDH, RDH, SDH	48041
		Maxitrol TS121A (option AG9H, NOTE: ships separate)			194261
89A	Gasket	For discharge sensor			104138
90	Time delay relay	Option AG8, AG9, or AG9H (T&B Agastat TM1ULA)			89661
91	Amplifier for modulating gas control options	Option AG8 (Maxitrol AD1010U)			260864
		Option AG9 or AG9H (Maxitrol A1010U)			260863
92	Mixing tube	Option AG8, AG9, or AG9H (NOTE: ships separate)			90323

ELECTRICAL COMPONENTS—CONTINUED

Table 3. Electrical Components—Continued

Item No.	Component	Description	Model(s)	PN	Figure Reference
Space-Mounted Thermostats and Controls					
93	Heating/cooling thermostat	Single-stage, 50–90°F, 24V (same as option CL1, Honeywell T812C1000)	All	255350	Figure 9
94		Two-stage, 40–90°F, 24V, electronic non-programmable (same as option CL22, (M/H TH5220D1159)		220630	
95		Electronic two-stage, 7-day programmable, touch screen (same as option CL23, M/H TB8220U1003)		257338	
96		45–88°F, 24 volt, heating/ cooling, 5-2 programmable (same as option CL52, M/H TH411D1007)		220632	
97		Electronic two-stage, 7-day programmable, 24V, switching subbase with auto/cool/off/heat switch and auto/on fan switch (same as option CL33, Honeywell #T7350D1008)		221038	
98	Locking thermostat cover	For items 80–83, height 6-1/2 (165mm) x width 7-1/2 (191 mm) x depth 2-15/16 (75 mm) (same as option CM1)	All	257464	Figure 9
		For items 80–84, height 7-1/4 (184 mm) x width 9-3/4 (248 mm) x depth 3-3/8 (86 mm) (same as option CM1B)		257463	
99	Room command module	Sensing space temperature (part of digital control options DG1 and DG2)	—**	211423	Figure 9
100		Sensing discharge temperature (part of digital control options DG5 and DG6)	All	211424	
101	Room override thermostat	Single-stage (optional part of digital control options DG5 and DG6, same as option CL56)	—**	220631	Figure 9
102	Wall-mounted space temperature sensor*	Option CL67 (used with options D12B, D12C, D12D, D12E, D12F, and D12G)		—	
103	Remote user interface	Optional (same as option RB2A for use with digital control options D12B, D12C, D12D, D12E, D12F, and D12G)	All	223125	Figure 9
104	Outside air relative humidity transmitter	Included with all D12 control options		206081	
105	Wall-mounted dehumidistat	Same as option CL47 (used with cooling coil with reheat option AU7)		177231	
Optional Remote Console Assemblies (Refer to Table 12 for Dimensions)					
106	Console box***	10-1/16 x 6-5/8 x 2-5/8	All	107010	Figure 9
		15-1/16 x 6-5/8 x 2-5/8		107011	
107	Mounting ring	For 10-1/16-inch-long console box	All	107014	Figure 9
		For 15-1/16-inch-long console box		107015	
108	Indicator light	Red, "BLOWER ON", "BURNER ON", "DIRTY FILTER", quantity = three (3) (Solico 3039-3-11-41610)	All	101889	Figure 9
109	Switch	SPDT, 15 amps (Cutler Hammer #7505K6)		101901	
110		DPDT, 15 amps (Cutler Hammer #7561K6)		101900	
111	Disconnect switch	Indoor or outdoor		Refer to Table 13	Figure 9
112	Thermostat	Heating, single-stage	255350	—	
113		Heating/cooling, single- or two-stage	220630		
114	Potentiometer	Refer to Table 50	16110		
*Part is no longer available. Order replacement PN 260599. This is not a direct replacement. Contact your factory representative or the factory Service Department for wiring instructions.					
**No longer available (may be used on some existing units). If replacement is required, contact your factory representative.					
***Includes mounting ring (item 107) so that the console may be wall-mounted. If the console is to be recessed instead, subtract 5/8-inch from the length and height. The box is of 16 gauge steel with knockout holes for field-wiring. The cover is made of plastic with custom engraving. Order replacement parts for option RC remote console by PN.					













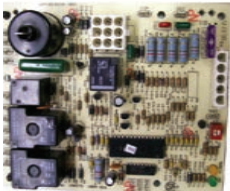


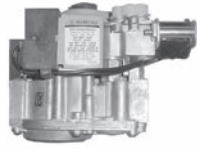



<p>Item 1: Phase Loss Control</p> 	<p>Item 2: Phase Loss and Over/Under Voltage Control</p> 	<p>Items 3 and 17: Plug-In Relay</p>  <p>Socket</p> 
<p>Items 4, 5, 13, and 16: Transformer</p> 	<p>Item 6: Terminal Board for Thermostat</p> 	<p>Item 9: Variable Frequency Drive Control</p> 
<p>Item 11: Dirty Filter Switch</p> 	<p>Item 14: Relay for Reheat</p> 	<p>Item 15: Contactor</p> 
<p>Items 12, 21, 22, and 23: Pressure Switch</p> 		<p>Item 24: High Temperature Limit Control</p> 
<p>Item 18: DSI Integrated Control Module</p> 	<p>Item 18A: ID Plug</p> 	
<p>Item 25: Single-Stage Gas Valve</p> 	<p>Item 26: Two-Stage Gas Valve</p> 	<p>Item 27: Modulating Gas Valve</p> 
<p>Item 28: Gas Pressure Switch</p>	<p>Natural Gas (PN 211130)</p> 	<p>Propane (PN 211710)</p> 

Figure 6. Individual Electrical Components—Items 1 through 28 (Refer to [Table 3](#))

NOTE: If replacing a single-stage valve (item 25, shown in [Figure 6](#)) with the type pictured on the right, order a valve bracket (PN 261650 for unit size 75, 100, 125, 130, or 150 or PN 261649 for unit size 175, 180, or 200).

ELECTRICAL COMPONENTS—CONTINUED

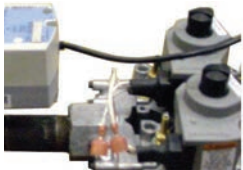

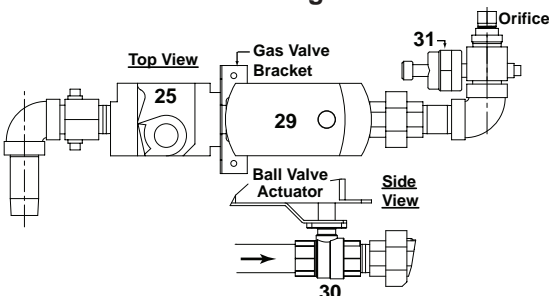
















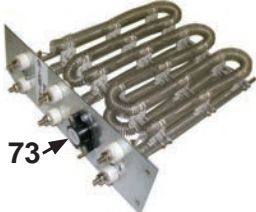

<p>Item 29: Ball Valve Actuator</p>  <p>Item 30: Ball Valve</p>	<p>Item 31: Pressure Transducer</p> 	
<p style="text-align: center;">Manifold Arrangement</p> 	<p>Item 32: Ductstat</p> 	
<p>Item 34: Signal Conditioner</p> 	<p>Item 35: Time Delay Relay</p> 	<p>Item 36: Venter Speed Controller</p> 
<p>Item 37: Electronic Filter</p> 	<p>Item 39: Digital Controller</p> <p>FX05</p> 	<p>Item 50: Plug-in Card</p> 
<p>Item 38: Time Delay Relay</p> 	<p>FX06</p> 	<p>Item 59: Outdoor and Discharge Air Sensor</p> 
<p>Item 60: Sensor Mixing Tube Holder</p> 	<p>Item 62: FX06 Digital Controller</p> 	
<p>Items 64 and 75: Transformer</p> 	<p>Item 66: Relay</p> 	<p>Items 68 and 69: Fuse Block and Fuse</p> 
<p>Item 71: Contactor</p> 	<p>Item 72: Heating Element Assembly</p>  <p style="text-align: center;">73</p>	

Figure 7. Individual Electrical Components—Items 29 through 73 (Refer to Table 3)








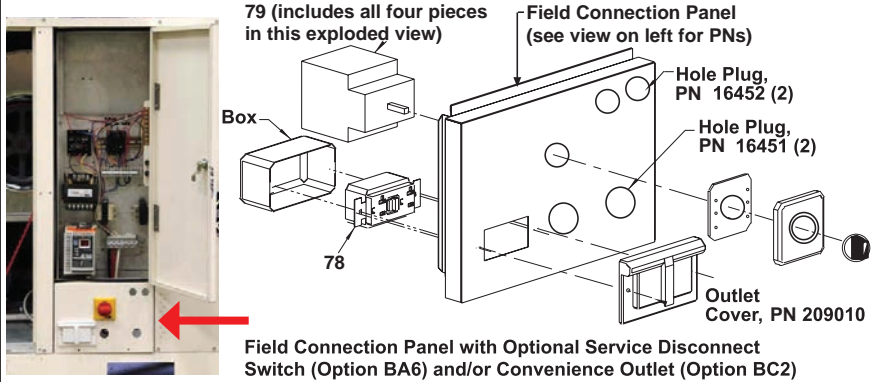
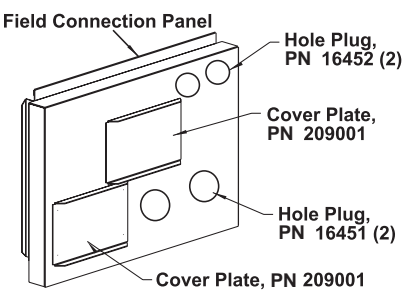



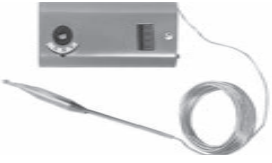



<p>Item 73: Limit Control</p> 	<p>Item 74 Step Controller</p> 	<p>Item 76: SCR Power Controller</p> 	
<p>Item 77: Reverse Flow Limit Switch</p> 	<p>Item 78: Convenience Outlet</p>  <p>Outlet Cover</p> 	<p>Item 79: Lockable Service Switch</p> 	
 <p>79 (includes all four pieces in this exploded view)</p> <p>Field Connection Panel (see view on left for PNs)</p> <p>Box</p> <p>78</p> <p>Hole Plug, PN 16452 (2)</p> <p>Hole Plug, PN 16451 (2)</p> <p>Outlet Cover, PN 209010</p> <p>Field Connection Panel with Optional Service Disconnect Switch (Option BA6) and/or Convenience Outlet (Option BC2)</p>		 <p>Field Connection Panel</p> <p>Hole Plug, PN 16452 (2)</p> <p>Cover Plate, PN 209001</p> <p>Hole Plug, PN 16451 (2)</p> <p>Cover Plate, PN 209001</p> <p>Field Connection Panel without Optional Service Disconnect Switch and/or Convenience Outlet has one or two cover plates</p>	
<p>Item 80: Safety Door Switch</p> 	<p>Item 81: Two-Position Switch</p> 	<p>Item 82: Firestat</p> 	
<p>Item 83: Ductstat/High Ambient Limit Control</p> 		<p>Item 87: - Sensor</p> 	
<p>Item 84: Ductstat Control</p> <p>Item 85: Ductstat Stage Adder</p> <p>Item 86: Digital Display Module</p>	<p>Item 84 Item 85 Item 86</p> 		<p>Item 88: Duct Smoke Detector</p> 

Figure 8. Individual Electrical Components—Items 73 through 88 (Refer to Table 3)

ELECTRICAL COMPONENTS—CONTINUED

<p>Item 89: Discharge Sensor for Modulating Gas Valve</p> 	<p>Item 90: Time Delay Relay</p> 	<p>Item 92: Mixing Tube</p> 
<p>Item 91: Amplifier for Modulating Gas Control Options</p>  <p style="text-align: center;"> PN 260864 PN 260863 </p>		<p>Item 93: Heating/Cooling Thermostat</p> 
<p>Item 94: Heating/Cooling Thermostat</p> 	<p>Item 95: Heating/Cooling Thermostat</p> 	<p>Item 96: Heating/Cooling Thermostat</p> 
<p>Item 97: Heating/Cooling Thermostat</p> 	<p>Item 98: Locking Thermostat Cover</p> 	<p>Item 99: Room Command Module</p> 
<p>Item 100: Room Command Module</p> 	<p>Item 101: Room Override Thermostat</p> 	<p>Item 103: Remote User Interface</p> 
<p>Item 104: Outside Air Relative Humidity Transmitter</p> 	<p>Item 105: Wall-Mounted Dehumidistat</p> 	

Figure 9. Individual Electrical Components—Items 89 through 105 (Refer to [Table 3](#))

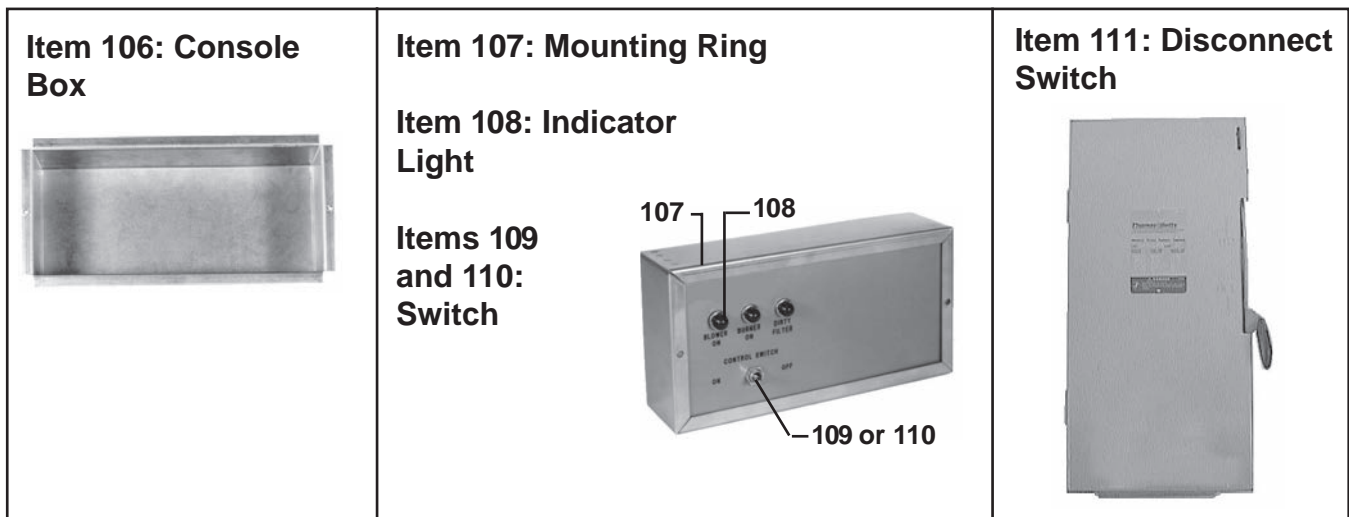


Figure 10. Individual Electrical Components—Items 106 through 111 (Refer to Table 3)

Motor Type	Motor HP	Voltage/PH/Hz	VFD Drive PN	Matching Line Reactor PN
Open, Totally-Enclosed Fan-Cooled (TEFC)	1/2	208/1/60, 230/1/60	221600	221595
		208/3/60, 230/3/60	221605	221598
		480/3/60	221612	221590
	3/4	208/3/60, 230/3/60	221606	221598
		480/3/60	221613	221591
		208/1/60, 230/1/60	221601	221596
Open, TEFC, Energy-Efficient (EE)	1	208/3/60, 230/3/60	221607	221594
		480/3/60	221594	221592
		208/1/60, 230/1/60	221602	221597
Open, TEFC	1-1/2	208/3/60, 230/3/60	221608	221595
Open, TEFC, EE		480/3/60	221615	221593
Open, TEFC		208/1/60, 230/1/60	221603	221597
Open, TEFC, EE	2	208/3/60, 230/3/60	221609	221596
		480/3/60	221616	221585
		575/3/60	221855	— (Built-in)
Open, TEFC	3	208/1/60, 230/1/60	221604	221599
		208/3/60, 230/3/60	221610	221597
		480/3/60	221617	221586
Open, TEFC, EE	5	575/3/60	221856	— (Built-in)
		208/3/60, 230/3/60	221611	221599
		480/3/60	221618	221587
		575/3/60	221857	— (Built-in)

ELECTRICAL COMPONENTS—CONTINUED

Table 5. DSI Integrated Control Module ID Plugs (Item 18A)						
Model	Serial No. Ignition Code	DSI Integrated Control Module PN	Heat Section Size	ID Plug PN	ID Plug Label	Gas
RDH	98	260252	175	258081	PREEVA 175NG	Natural
				258082	PREEVA 175LP	Propane
			200	258083	PREEVA 200NG	Natural
				258084	PREEVA 200LP	Propane
			225	258085	PREEVA 225NG	Natural
				258086	PREEVA 225LP	Propane
			250	258087	PREEVA 250NG	Natural
				258088	PREEVA 250LP	Propane
			300	258089	PREEVA 300NG	Natural
				258090	PREEVA 300LP	Propane
			350	258091	PREEVA 350NG	Natural
				258092	PREEVA 350LP	Propane
			400	258093	PREEVA 400NG	Natural
				258094	PREEVA 400LP	Propane
RHH, SHH	99	260917	130	258101	SHH 130NG	Natural
				258102	SHH 130LP	Propane
			180	258103	SHH 180NG	Natural
				258104	SHH 180LP	Propane
			260	258105	SHH 260NG	Natural
				258106	SHH 260LP	Propane
			350	258107	SHH 350NG	Natural
				258108	SHH 350LP	Propane

Table 6. Combustion Air Pressure Switches (Items 21 and 22) for Gas-Fired Models							
Model	Unit Size	High Speed (Item 21)				Low Speed (Item 22)	
		Elevation = Sea Level to 6000 Feet (1830 Meters)		Elevation = >6000 Feet (1830 Meters)		All Elevations	
		Switch PN	Setting (IN WC)	Switch PN	Setting (IN WC)	Switch PN*	Setting (IN WC)
PDH, SDH, RDH	75	197030	0.40	197031	0.35	205442	0.20
	100	197030	0.40	197031	0.35	205444	0.30
	125	196388	0.50	197032	0.45	205444	0.30
	150	197028	0.65	197029	0.60	205444	0.30
	175	201158	1.10	201160	1.05	197030	0.40
	200	201158	1.10	201160	1.05	197030	0.40
	225	201158	1.10	201160	1.05	197030	0.40
	250	201158	1.10	201160	1.05	197030	0.40
	300	201158	1.10	201160	1.05	197030	0.40
	350	201158	1.10	201160	1.05	197030	0.40
400A	201158	1.10	201160	1.05	197030	0.40	
Model	Unit Size	High Speed (Item 21)		Low Speed (Item 22)			
		Switch PN	Setting (IN WC)	Switch PN	Setting (IN WC)		
SHH, RHH	130	201161**			1.30	—	
		201160***			1.05		
	180	201161**			1.30		
		201160***			1.05		
	260	201159**			1.40		
		201160***			1.05		
	350	221228**			2.30		
		201160***			1.05		

*Applies to units with a two-speed venter and gas control option AG8, AG9, AG9H, AG40, AG60, AG61, AG62, DG1, DG2, DG5, DG6, D12B, or D12C.
 **Applies to units with option AG2 or D12F.
 ***Applies to units with option AG58 or D12G.

Table 6. Combustion Air Pressure Switches (Items 21 and 22) for Gas-Fired Models—Cont.

Model	Unit Size	High Speed (Item 21)		Low Speed (Item 22)	
		Switch PN	Setting (IN WC)	Switch PN	Setting (IN WC)
RDH	175	197029***	0.60	—	
	200	197078***	0.80		
	225				
	250	205446***	0.70		
	300				
	350				
	400A				

*Applies to units with a two-speed venter and gas control option AG8, AG9, AG9H, AG40, AG60, AG61, AG62, DG1, DG2, DG5, DG6, D12B, or D12C.

**Applies to units with option AG2 or D12F.

***Applies to units with option AG58 or D12G.

Table 7. Modulating Gas Valves (Item 27) Used in Models PDH, RDH, and SDH

Option	Gas	Unit Size			
		75, 100, 125	150	175, 200	225, 300, 350, 400A
		PN			
AG8, AG9, AG9H	Natural Gas	269988	269989		269990
	Propane	269991	271240		269992
DG2, DG6, AG40, D12B	Natural Gas	213743		213744	213745
	Propane	213746			213748

Table 8. Venter Speed Controllers (Item 36)

Unit Size	Voltage/PH (Option)	Fuel (Option)	PN
75	208/1, 208/3 (AK2, AK5)	Natural gas (AA1)	215197
		Propane (AA2)	
	230/1, 230/3, 460/3, 575/3 (AK3, AK6, AK7, AK8)	Natural gas (AA1)	213583
		Propane (AA2)	
100	208/1, 208/3 (AK2, AK5)	Natural gas (AA1)	215197
		Propane (AA2)	
	230/1, 230/3, 460/3, 575/3 (AK3, AK6, AK7, AK8)	Natural gas (AA1)	213584
		Propane (AA2)	
125	208/1, 208/3 (AK2, AK5)	Natural gas (AA1)	213582
		Propane (AA2)	213581
	230/1, 230/3, 460/3, 575/3 (AK3, AK6, AK7, AK8)	Natural gas (AA1)	213579
		Propane (AA2)	
150	208/1, 208/3 (AK2, AK5)	Natural gas (AA1)	213582
		Propane (AA2)	213581
	230/1, 230/3, 460/3, 575/3 (AK3, AK6, AK7, AK8)	Natural gas (AA1)	213577
		Propane (AA2)	213579
175	208/1, 208/3 (AK2, AK5)	Natural gas (AA1)	213579
		Propane (AA2)	213577
	230/1, 230/3, 460/3, 575/3 (AK3, AK6, AK7, AK8)	Natural gas (AA1)	213579
		Propane (AA2)	213578
200	208/1, 208/3 (AK2, AK5)	Natural gas (AA1)	213581
		Propane (AA2)	
	230/1, 230/3, 460/3, 575/3 (AK3, AK6, AK7, AK8)	Natural gas (AA1)	213578
		Propane (AA2)	
225	208/1, 208/3 (AK2, AK5)	Natural gas (AA1)	213582
		Propane (AA2)	213581
	230/1, 230/3, 460/3, 575/3 (AK3, AK6, AK7, AK8))	Natural gas (AA1)	213579
		Propane (AA2)	213577
250	208/1, 208/3 (AK2, AK5)	Natural gas (AA1)	213579
		Propane (AA2)	213580
	230/1, 230/3, 460/3, 575/3 (AK3, AK6, AK7, AK8))	Natural gas (AA1)	213576
		Propane (AA2)	

ELECTRICAL COMPONENTS—CONTINUED

Table 8. Venter Speed Controllers (Item 36)—Continued										
Unit Size		Voltage/PH (Option)				Fuel (Option)			PN	
300		208/1, 208/3 (AK2, AK5)				Natural gas (AA1)			213581	
						Propane (AA2)				
		230/1, 230/3, 460/3, 575/3 (AK3, AK6, AK7, AK8)				Natural gas (AA1)			213579	
						Propane (AA2)				
350		208/1, 208/3 (AK2, AK5)				Natural gas (AA1)			213582	
						Propane (AA2)				
		230/1, 230/3, 460/3, 575/3 (AK3, AK6, AK7, AK8)				Natural gas (AA1)			213581	
						Propane (AA2)				
400		208/1, 208/3 (AK2, AK5)				Natural gas (AA1)			213582	
						Propane (AA2)				
		230/1, 230/3, 460/3, 575/3 (AK3, AK6, AK7, AK8)				Natural gas (AA1)			213581	
						Propane (AA2)				
PN	% of Full Speed	DIP Switch								
		1	2	3	4	5	6	7	8	
Setting										
213576	56	ON			OFF	ON				ON
213577	58	ON	OFF			ON				
213578	60	OFF	ON	OFF	ON					
213579	62	OFF			ON					
213580	64	OFF	ON							
213581	67	OFF								
213582	70	ON			OFF					
213583	80	OFF			ON	OFF				
213584	85	ON	OFF			ON				
215197	88	OFF			ON	OFF	ON			

NOTE: Components listed in Table 9 and Table 10 apply to units with either SCR option D12D or two-stage option D12E unless otherwise indicated.

Table 9. Electric Heat Section (Models PEH and REH) Components (Items 68, 69, 71, 72, 74, and 76) (Unit Sizes 10A Through 40A)								
Item No.	Component	Voltage/PH/Hz (Option)	Unit Size					
			10A	15B	20A	30B	30D	40A
PN (Quantity)								
68	Fuse block	208/1/60 (AK2)	223494 (1)	223493 (1)	223494 (2)	223494 (3)	—	
		230/1/60 (AK3)		223494 (1)				
				223493 (1)				
				223494 (1)				
		208/3/60 (AK5)	—	207631 (1)	207618 (1)		207631 (2)	
					207631 (1)			
230/3/60 (AK6)	207618 (1)							
	207631 (1)							
460/3/60 (AK8)	207629 (1)				207630 (1)			
	575/3/60 (AK8)							

**Table 9. Electric Heat Section (Models PEH and REH) Components (Items 68, 69, 71, 72, 74, and 76)
(Unit Sizes 10A Through 40A)—Continued**

Item No.	Component	Voltage/PH/Hz (Option)	Unit Size							
			10A	15B	20A	30B	30D	40A	40E	
			PN (Quantity)							
69	Fuse	208/1/60 (AK2)	207616 (2)	223492 (2) 207616 (2)	207616 (4)	207616 (6)	—			
		230/1/60 (AK3)	207617 (2)	207615 (2) 207617 (2)	207617 (4)	207617 (6)	—			
		208/3/60 (AK5)	—	207617 (3)	207615 (3)		207617 (6)	—		
		230/3/60 (AK6)			207617 (3)					
		460/3/60 (AK8)			207615 (3)					
		575/3/60 (AK8)	207617 (3)		207625 (3)	207627 (3)	207628 (3)	—		
71	Contactor	208/1/60 (AK2)	216388 (1)* 216386 (2)**	216386 (1) 216388 (1)	216388 (2)* 208375 (2)**	216388 (3)	—			
		230/1/60 (AK3)	216388 (1)* 216386 (2)**	216386 (1) 216388 (1)	216388 (2)* 208375 (2)**					
		208/3/60 (AK5)	—	216388 (1)* 216386 (2)**	216388 (1)*	216386 (1)* 216388 (1)*	216386 (1)	216388 (2)*	216388 (2)	
		230/3/60 (AK6)			216386 (2)**	216386 (2)** 216388 (2)**	216388 (1)	208375 (2)**	216386 (4)*	
		460/3/60 (AK8)			216386 (2)	216386 (2)	216386 (3)* 216386 (1)**	216386 (4)*		
		575/3/60 (AK8)			216388 (2)	216388 (2)	216388 (1)**	208375 (2)**	216388 (2)**	—
		208/1/60 (AK2)	—	216386 (1)* 216386 (2)** 216386 (1)* 216386 (2)**	216386 (2)	208375 (1)*	208375 (1)*	216386 (2)		
		230/1/60 (AK3)				216386 (2)**	216386 (2)**	216386 (2)		
		460/3/60 (AK8)				216386 (1)*	208375 (1)*	216386 (2)		
		575/3/60 (AK8)				216386 (2)**	208375 (1)*	216386 (2)		
72	Heating element assembly	208/1/60 (AK2)	223174 (2)	223174 (3)	223174 (4)		—			
		230/1/60 (AK3)								
		208/3/60 (AK5)	—	221687 (2)	221687 (3)*	221687 (3)	221687 (4)			
		230/3/60 (AK6)			221687 (6)**					
		460/3/60 (AK8)			221688 (2)	221688 (3)	221688 (4)			
575/3/60 (AK8)	221689 (2)	221689 (3)			221689 (4)					
74	Step controller**	208/1/60 (AK2)	—	—	—	234059 (1)	—			
		230/1/60 (AK3)				—				
		208/3/60 (AK5)				234059 (1)				
		230/3/60 (AK6)				—				
		460/3/60 (AK8)				—				
		575/3/60 (AK8)				—				
76	SCR power controller**	208/1/60 (AK2)	223175 (1)	223175 (2)		223175 (1)	—			
		230/1/60 (AK3)								
		208/3/60 (AK5)	—	—	234057 (1)	234057 (2)				
		230/3/60 (AK6)			234057 (2)	234057 (1)				
		460/3/60 (AK8)			234057 (1)		234057 (2)			
		575/3/60 (AK8)			234057 (1)					

*Units with SCR option D12D only.

**Units with two-stage option D12E only.

ELECTRICAL COMPONENTS—CONTINUED

Table 10. Electric Heat Section (Models PEH and REH) Components (Items 68, 69, 71, 72, 74, and 76) (Unit Sizes 40E Through 120E)										
Item No.	Component	Voltage/PH/Hz (Option)	Unit Size							
			60B	60D	80E	90D	120D	120E		
PN (Quantity)										
68	Fuse block	208/3/60 (AK5)	207631 (3)		207631 (4)	207618 (1)	207631 (6)			
		230/3/60 (AK6)				207631 (1)*				
						207631 (4)**				
		460/3/60 (AK8)				207618 (1)				
						207631 (1)*				
		575/3/60 (AK8)	207631 (4)**							
		69	Fuse	208/3/60 (AK5)	207617 (9)		207617 (12)	207630 (3)*	207630 (3)	
				230/3/60 (AK6)				207629 (1)**		
207630 (2)**										
460/3/60 (AK8)	207630 (3)*									
	207629 (1)**									
575/3/60 (AK8)	207630 (2)**									
71	Contactor	208/3/60 (AK5)	216386 (2)	216388 (3)* 216386 (6)*	216388 (4)	216386 (1)	216388 (6)			
		230/3/60 (AK6)	216388 (2)	216388 (2)** 216388 (2)**		216388 (4)				
			460/3/60 (AK8)	216386 (2)	216388 (3)* 216386 (6)*	216388 (6)*	216386 (3)* 216388 (3)*	216386 (2)* 216388 (5)*		
		575/3/60 (AK8)		216388 (2)	216386 (2)** 216388 (2)**	216388 (4)**	216386 (1)** 216388 (4)**	216388 (6)**		
			72	Heating element assembly	208/3/60 (AK5)	221687 (6)		221687 (8)	221687 (9)	221687 (12)
		230/3/60 (AK6)								
		460/3/60 (AK8)			221688 (6)		221688 (8)	221688 (9)	221688 (12)	
		575/3/60 (AK8)			221689 (6)		221689 (8)	221689 (9)	221689 (12)	
		74	Step controller*	208/3/60 (AK5)	234059 (1)		234059 (1)		234060 (1)	
				230/3/60 (AK6)	234060 (1)					
				460/3/60 (AK8)	—		234059 (1)	234059 (1)		
				575/3/60 (AK8)	—		—	234059 (1)		
76	SCR power controller**	208/3/60 (AK5)	234057 (1)		234057 (1)					
		230/3/60 (AK6)			234057 (2)					
		460/3/60 (AK8)	234057 (2)		234057 (1)		234057 (2)			
		575/3/60 (AK8)			234057 (2)	234057 (1)				

*Units with SCR option D12D only.

**Units with two-stage option D12E only.

Unit Size	Voltage/PH (Option)					Unit Size	
	208/1 (AK2)	230/1 (AK3)	208/3 (AK5)	230/3 (AK6)	460/3 (AK7)		575/3 (AK8)
	PN						
10A	205907	205908	—			10A	
15B	205908	207678	—			15B	
20A	207678	207679	205907		205906		20A
30B	207679		205908	207678	205906		30B
30D			—				30D
40A	—		207678	207679	205907	205906	40A
40E			—		40E		
60B			207679		205908		60B
60D			—		60D		
80E			207679	222422	207678		80E
90D	222422	—	207679	207678	90D		
120D	—		207679			120D	
120E	—		207679			120E	

Console Option	Dimensions (Inches)*		
	Length	Height	Depth
RC1, RC2, RC3, RC4, RC5, RC6, RC9	10-3/4	7-5/8	2-5/8
RC7, RC8, RC10, RC12 (without optional control on console)			
RC7, RC8, RC10, RC12 (with optional control on console)	15-3/4	7-5/8	2-5/8
RC11			

*Approximate remote console assembly dimension with mounting ring. Subtract 5/8 inch from length and height when recess-mounting console (recess-mounting does not use mounting ring).

Amps	Voltage	Fusible* or Non-Fusible	Indoor		Outdoor	
			PN	Same as Option:	PN	Same as Option:
For Use in US						
30	240	Non-Fusible	40267	CP1	40269	CP5
		Fusible	40268	CP2	87147	CP6
	600	Non-Fusible	50365	CP3	50367	CP7
		Fusible	50366	CP4	50368	CP8
60	240	Non-Fusible	161462	CP21	161469	CP30
		Fusible	89932	CP17	89932	CP17
	600	Non-Fusible	161464	CP23	155012	CP38
		Fusible	90974	CP20	90974	CP20
100	240	Non-Fusible	161463	CP22	162834	CP31
		Fusible	161468	CP28	90973	CP18
	600	Non-Fusible	164330	CP24	155013	CP39
		Fusible	155010	CP36	155010	CP36
200	240	Non-Fusible	155005	CP26	155007	CP32
		Fusible	155006	CP29	91076	CP19
	600	Non-Fusible	155009	CP35	155014	CP40
		Fusible	155008	CP34	155011	CP37
400	240	Fusible	223658	CP72	223658	CP72
	600	Non-Fusible	223660	CP78	223660	CP78
			Fusible	223659	CP76	223659

*Fuse is not included.

ELECTRICAL COMPONENTS—CONTINUED

Table 13. Disconnect Switches (Item 113)—Continued						
Amps	Voltage	Fusible* or Non-Fusible	Indoor		Outdoor	
			PN	Same as Option:	PN	Same as Option:
For Use in Canada						
30	600	Non-Fusible	208053	CP58	208054	CP59
		Fusible	208045	CP41	208046	CP42
60		Non-Fusible	208055	CP60	208056	CP61
		Fusible	208047	CP43	208048	CP44
100		Non-Fusible	208057	CP62	208058	CP63
		Fusible	208049	CP45	208050	CP46
200		Non-Fusible	208059	CP64	208060	CP65
		Fusible	208051	CP47	208052	CP48
400	Fusible	223661	CP80	223661	CP80	

*Fuse is not included.

BLOWER MOTORS, CONTACTORS, AND STARTERS

NOTE:

- The motor contactor (see [Figure 11](#)) used on single-speed blower motors is PN [216386](#) (replaces PN [119625](#)) and the starter is option AN10 (see [Figure 11](#)).
- Single-speed blower motors are listed by type, HP, and voltage. **Highlighted motors in [Table 14](#), [Table 15](#), and [Table 16](#) do not have internal overload protection and MUST be used with the starter and overloads listed unless the unit is equipped with a variable frequency drive (item 9, [Table 3](#)).**
- Motors not highlighted will have either a contactor and starter or will be equipped with a variable frequency drive (option VFD, refer to [Table 4](#)).
- Two-speed blower motors are listed in [Table 17](#).

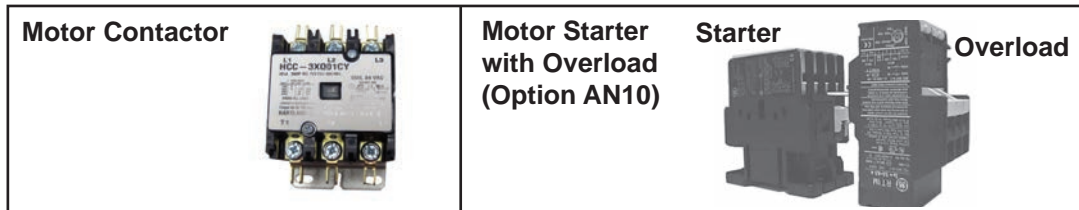


Figure 11. Motor Contactor and Starter (Refer to [Table 14](#), [Table 15](#), and [Table 16](#))

Table 14. Open-Type Blower Motors by Motor Option and Starter

HP	Option	Blower Motor					Starter (Option AN10)		Starter Overload					
		MFR's Model	Frame Size	Full Load Amps (FLA)	Shaft Size (Inches)	Voltage/Phase	PN	MFR's Model	PN	GE Model	Min Amps	Max Amps	PN	
1/4	AL2, AL3	BF2024	48/56	4.6	1/2	115/1	210611	CL00A310T-1	151275	RTA1-L	4.0	6.3	151191	
		BF2024	48/56	2.3	1/2	208/1	210611	CL00A310T-1	151275	RTA1-J	1.8	2.7	151189	
		BF2024	48/56	2.3	1/2	240/1	210611	CL00A310T-1	151275	RTA1-J	1.8	2.7	151189	
		H200	K48	1.1	1/2	208/3	115864	CL00A310T-1	151275	RTA1-G	1.0	1.5	151187	
		H200	K48	1.4	1/2	240/33	115864	CL00A310T-1	151275	RTA1-G	1.0	1.5	151187	
		H200	K48	0.8	1/2	480/3	115864	CL00A310T-1	151275	RTA1-F	0.7	1.1	151186	
1/3	AL2, AL3	BF2034	48	6.0	1/2	115/1	202091	CL00A310T-1	151275	RTA1-L	4.0	6.3	151191	
		BF2034	48	3.0	1/2	208/1	202091	CL00A310T-1	151275	RTA1-K	2.5	4.1	151190	
		H260	K48	1.4	1/2	208/3	115863	CL00A310T-1	151275	RTA1-G	1.0	1.5	151187	
		H260	K48	1.6	1/2	240/3	115863	CL00A310T-1	151275	RTA1-H	1.3	1.9	151188	
		H260	K48	0.8	1/2	480/3	115863	CL00A310T-1	151275	RTA1-F	0.7	1.1	151186	
1/2	AL4, AL5	BF2054	56Z	8.8	5/8	120/1	102627	CL00A310T-1	151275	RTA1-N	8.0	12.0	151193	
		BF2054	56Z	5.1	5/8	208/1	102627	CL00A310T-1	151275	RTA1-L	4.0	6.3	151191	
		BF2054	56Z	4.4	5/8	240/1	102627	CL00A310T-1	151275	RTA1-L	4.0	6.3	151191	
		H880	LA56	2.5	5/8	208/3	159183	CL00A310T-1	151275	RTA1-J	1.8	2.7	151189	
		H880	LA56	3.0	5/8	240/3	159183	CL00A310T-1	151275	RTA1-K	2.5	4.1	151190	
		H880	LA56	1.5	5/8	480/3	159183	CL00A310T-1	151275	RTA1-H	1.3	1.9	151188	
3/4	AL4, AL5	H991	H56	0.9	5/8	575/3	202089	CL00A310T-1	151275	RTA1-F	0.7	1.1	151186	
		312P629	B56	11.0	5/8	120/1	93548	CL01A310T-1	151276	RTA1-P	10.0	16.0	151194	
		312P629	B56	6.3	5/8	208/1	93548	CL00A310T-1	151275	RTA1-M	5.5	8.5	151192	
		312P629	B56	5.5	5/8	240/1	93548	CL00A310T-1	151275	RTA1-L	4.0	6.3	151191	
		312P696	D56	2.9	5/8	208/3	36951	CL00A310T-1	151275	RTA1-K	2.5	4.1	151190	
		312P696	D56	2.6	5/8	240/3	36951	CL00A310T-1	151275	RTA1-K	2.5	4.1	151190	
1	AL6, AL7	312P696	D56	1.3	5/8	480/3	36951	CL00A310T-1	151275	RTA1-G	1.0	1.5	151187	
		H992	H56	1.0	5/8	575/3	202090	CL00A310T-1	151275	RTA1-F	0.7	1.1	151186	
		C523	H56	13.0	5/8	120/1	13685	CL01A310T-1	151276	RTA1-P	10.0	16.0	151194	
		C523	H56	7.5	5/8	208/1	13685	CL00A310T-1	151275	RTA1-M	5.5	8.5	151192	
		C523	H56	6.5	5/8	240/1	13685	CL00A310T-1	151275	RTA1-M	5.5	8.5	151192	
		AOS H882L	56H	4.0	5/8	208/3	36580	CL00A310T-1	151275	RTA1-K	2.5	4.1	151190	
	1.5	AL6, AL7	AOS H882L	56H	3.7	5/8	240/3	36580	CL00A310T-1	151275	RTA1-K	2.5	4.1	151190
			AOS H882L	56H	2.0	5/8	480/3	36580	CL00A310T-1	151275	RTA1-J	1.8	2.7	151189
			AOS H959	JA56	1.4	5/8	575/3	158175	CL00A310T-1	151275	RTA1-G	1.0	1.5	151187
			C621	56	15.0	5/8	120/1	194202	CL01A310T-1	151276	RTA1-P	10.0	16.0	151194
			C621	56	7.8	5/8	208/1	194202	CL00A310T-1	151275	RTA1-M	5.5	8.5	151192
			C621	56	7.5	5/8	240/1	194202	CL00A310T-1	151275	RTA1-M	5.5	8.5	151192
2	AL8	H884	UA56	5.6	5/8	208/3	115859	CL00A310T-1	151275	RTA1-L	4.0	6.3	151191	
		H884	UA56	5.0	5/8	240/3	115859	CL00A310T-1	151275	RTA1-L	4.0	6.3	151191	
		H884	UA56	2.8	5/8	480/3	115859	CL00A310T-1	151275	RTA1-K	2.5	4.1	151190	
		AOS H960	LA56H	2.0	7/8	575/3	158162	CL00A310T-1	151275	RTA1-J	1.8	2.7	151189	
		RB1204A	56	24.6	7/8	120/1	202581	CL04A310M-1	151279	RTA1-U	21.0	26.0	151198	
		RB1204A	56	12.3	7/8	208/1	202581	CL01A310T-1	151276	RTA1-P	10.0	16.0	151194	
3	AL9	RB1204A	56	12.3	7/8	240/1	202581	CL01A310T-1	151276	RTA1-P	10.0	16.0	151194	
		H886	56HZ	7.0	7/8	208/3	159327	CL00A310T-1	151275	RTA1-M	5.5	8.5	151192	
		H886	56HZ	6.6	7/8	240/3	159327	CL00A310T-1	151275	RTA1-M	5.5	8.5	151192	
		H886	56HZ	3.5	7/8	480/3	159327	CL00A310T-1	151275	RTA1-K	2.5	4.1	151190	
		AOS H965V1	L56	2.6	7/8	575/3	158176	CL00A310T-1	151275	RTA1-J	1.8	2.7	151189	
		B735	L56	13.7	5/8	208/1	111560	CL01A310T-1	151276	RTA1-P	10.0	16.0	151194	
5	AL9, AL10	B735	L56	12.4	5/8	230/1	111560	CL01A310T-1	151276	RTA1-P	10.0	16.0	151194	
		H845	P56HZ	9.0	7/8	208/3	159185	CL00A310T-1	151275	RTA1-N	8.0	12.0	151193	
		H845	P56HZ	8.6	7/8	240/3	159185	CL00A310T-1	151275	RTA1-N	8.0	12.0	151193	
		H845	P56HZ	4.3	7/8	480/3	159185	CL00A310T-1	151275	RTA1-L	4.0	6.3	151191	
		H954	N56HZ	3.6	7/8	575/3	120019	CL00A310T-1	151275	RTA1-K	2.5	4.1	151190	
		Baldor L1409T	184T	25.5	1-1/8	208/1	111562	CL04A310M-1	151279	RTA1-U	21.0	26.0	151198	
Baldor L1409T	184T	23.0	1-1/8	240/1	111562	CL04A310M-1	151279	RTA1-U	21.0	26.0	151198			
5	AL9, AL10	196033	Y56HZ	13.4	7/8	208/3	113371	CL01A310T-1	151276	RTA1-P	10.0	16.0	151194	
		196033	Y56HZ	13.2	7/8	240/3	113371	CL01A310T-1	151276	RTA1-P	10.0	16.0	151194	
		196033	Y56HZ	6.6	7/8	480/3	113371	CL00A310T-1	151275	RTA1-M	5.5	8.5	151192	
		H956	Y56HZ	5.4	7/8	575/3	120020	CL00A310T-1	151275	RTA1-L	4.0	6.3	151191	

BLOWER MOTORS, CONTACTORS, AND STARTERS—CONTINUED

Table 15. TEFC-Type Blower Motors by Motor Option and Starter

HP	Option	Blower Motor						Starter (Option AN10)		Starter Overload			
		MFR's Model	Frame Size	Full Load Amps (FLA)	Shaft Size (Inches)	Voltage/Phase	PN	MFR's Model	PN	GE Model	Min Amps	Max Amps	PN
1/4	AL19	Regal Beloit C664	H56	3.8	5/8	120/1	16074*	CL00A310T-1	151275	RTA1-K	2.5	4.1	151189
		Regal Beloit C664	H56	2.0	5/8	208/1	16074*	CL00A310T-1	151275	RTA1-K	2.5	4.1	151189
		Regal Beloit C664	H56	1.9	5/8	240/1	16074*	CL00A310T-1	151275	RTA1-K	2.5	4.1	151189
		US T14S2A	56	1.1	5/8	208/3	271443**	CL00A310T-1	151275	RTA1-G	1.0	1.5	151187
		US T14S2A	56	1.1	5/8	240/3	271443**	CL00A310T-1	151275	RTA1-G	1.0	1.5	151187
		US T14S2A	56	0.5	5/8	480/3	271443**	CL00A310T-1	151275	RTA1-D	0.4	0.65	151184
1/3	AL20	STK906	N48	4.6	1/2	120/1	115861	CL00A310T-1	151275	RTA1-L	4.0	6.3	151191
		C151	N48	2.3	1/2	208/1	159501	CL00A310T-1	151275	RTA1-J	1.8	2.7	151189
		C151	N48	2.4	1/2	240/1	159501	CL00A310T-1	151275	RTA1-J	1.8	2.7	151189
		H261	L48	1.2	1/2	208/3	105567	CL00A310T-1	151275	RTA1-G	1.0	1.5	151187
		H261	L48	1.2	1/2	240/3	105567	CL00A310T-1	151275	RTA1-G	1.0	1.5	151187
		H261	L48	0.6	1/2	480/3	105567	CL00A310T-1	151275	RTA1-D	0.4	0.7	151184
1/2	AL21, AL22, AL23	C613	J56	7.2	5/8	120/1	159184	CL00A310T-1	151275	RTA1-M	5.5	8.5	151192
		C613	J56	3.5	5/8	208/1	159184	CL00A310T-1	151275	RTA1-K	2.5	4.1	151190
		C613	J56	3.6	5/8	240/1	159184	CL00A310T-1	151275	RTA1-K	2.5	4.1	151190
		H274	H56	2.3	5/8	208/3	16077	CL00A310T-1	151275	RTA1-J	1.8	2.7	151189
		H274	H56	2.0	5/8	240/3	16077	CL00A310T-1	151275	RTA1-J	1.8	2.7	151189
		H274	H56	1.0	5/8	480/3	16077	CL00A310T-1	151275	RTA1-F	0.7	1.1	151186
3/4	AL21, AL22, AL23	H276	J56	0.7	5/8	575/3	105568	CL00A310T-1	151275	RTA1-F	0.7	1.1	151186
		F353	F56	11.0	5/8	120/1	115860	CL01A310T-1	151276	RTA1-P	10.0	16.0	151194
		F353	F56	5.4	5/8	208/1	115860	CL00A310T-1	151275	RTA1-L	4.0	6.3	151191
		F353	F56	5.5	5/8	240/1	159184	CL00A310T-1	151275	RTA1-L	4.0	6.3	151191
		H580	KA56	2.0	5/8	208/3	20371	CL00A310T-1	151275	RTA1-J	1.8	2.7	151189
		H580	KA56	2.2	5/8	240/3	20371	CL00A310T-1	151275	RTA1-J	1.8	2.7	151189
1	AL21, AL22, AL23	H580	KA56	1.1	5/8	480/3	20371	CL00A310T-1	151275	RTA1-G	1.0	1.5	151187
		H461	L56	0.8	5/8	575/3	105569	CL00A310T-1	151275	RTA1-F	0.7	1.1	151186
		159105	L56	12	5/8	120/1	174993	CL01A310T-1	151276	RTA1-P	10.0	16.0	151194
		159105	L56	6.2	5/8	208/1	174993	CL00A310T-1	151275	RTA1-L	4.0	6.3	151191
		159105	L56	6	5/8	240/1	174993	CL00A310T-1	151275	RTA1-L	4.0	6.3	151191
		WEG-00118E	D56	3.3	5/8	208/3	271444**	CL00A310T-1	151275	RTA1-K	2.5	4.1	151190
		WEG-00118E	D56	3.1	5/8	240/3	271444**	CL00A310T-1	151275	RTA1-K	2.5	4.1	151190
		WEG-00118E	D56	1.6	5/8	480/3	271444**	CL00A310T-1	151275	RTA1-H	1.3	1.9	151188
1.5	AL24	H525	H56	1.4	5/8	575/3	105570	CL00A310T-1	151275	RTA1-G	1.0	1.5	151187
		311P402	TK56H	16.4	5/8	120/1	94347	CL02A310T-1	151277	RTA1-S	14.5	18.0	151196
		311P402	TK56H	9.5	5/8	208/1	94347	CL00A310T-1	151275	RTA1-N	8.0	12.0	151193
		311P402	TK56H	8.2	5/8	240/1	94347	CL00A310T-1	151275	RTA1-N	8.0	12.0	151193
		WEG-00158E	D56	4.8	5/8	208/3	271445**	CL00A310T-1	151275	RTA1-L	4.0	6.3	151191
		WEG-00158E	D56	4.6	5/8	240/3	271445**	CL00A310T-1	151275	RTA1-L	4.0	6.3	151191
		WEG-00158E	D56	2.3	5/8	480/3	271445**	CL00A310T-1	151275	RTA1-J	1.8	2.7	151189
2	AL25	AOS T59027	145T	1.7	7/8	575/3	105665	CL00A310T-1	151275	RTA1-H	1.3	1.9	151188
		K200	F182T	24	1-1/8	120/1	105572	CL04A310M-1	151279	RTA1-U	21	26	151198
		L3516TM	F182T	8.3	7/8	240/1	205881	CL00A310T-1	151275	RTA1-M	5.5	8.5	151192
		West NP0024	145T	6.1	7/8	208/3	158165	CL00A310T-1	151275	RTA1-M	5.5	8.5	151192
		West NP0024	145T	5.6	7/8	240/3	158165	CL00A310T-1	151275	RTA1-L	4.0	6.3	151191
		West NP0024	145T	2.8	7/8	480/3	158165	CL00A310T-1	151275	RTA1-K	2.5	4.1	151190
		T59028	145T	2.3	7/8	575/3	158166	CL00A310T-1	151275	RTA1-J	1.9	2.7	151189

*Shaft size change: blower motor and replacement blower motor both have a 5/8 inch shaft size (original AOS motor was 1/2 inch). The US T14CA2J9 blower motor requires a starter overload (PN 151192). The Regal Beloit C664 motor replaces US T14CA2J9.

**Starter required: consult the factory-provided wiring diagram or serial number to determine the appropriate starter and overload.

***Shaft size change: replacement motor shaft size is 7/8 inch (original motor was 1-1/8 inch).

Table 15. TEFC-Type Blower Motors by Motor Option and Starter—Continued

HP	Option	Blower Motor						Starter (Option AN10)		Starter Overload			
		MFR's Model	Frame Size	Full Load Amps (FLA)	Shaft Size (Inches)	Voltage/Phase	PN	MFR's Model	PN	GE Model	Min Amps	Max Amps	PN
3	AL26	K222	F184T	30	1-1/8	120/1	111564	CL04A310M-1	151279	RTA1-V	25	32	151199
		K222	F184T	15	1-1/8	240/1	111564	CL02A310T-1	151277	RTA1-S	14.5	18	151196
		B - EM3559T	145T	7.9	7/8	208/3	159330	CL00A310T-1	151275	RTA1-N	5.5	8.5	151192
		B - EM3559T	145T	7.2	7/8	240/3	159330	CL00A310T-1	151275	RTA1-N	5.5	8.5	151192
		B - EM3559T	145T	3.6	7/8	480/3	159330	CL00A310T-1	151275	RTA1-K	2.5	4.1	151190
5	AL27	B-EM3559T-5	145T	2.8	7/8	575/3	158168***	CL00A310T-1	151275	RTA1-K	2.5	4.1	151190
		K223	F184T	20.2	1-1/8	240/1	111567	CL25A310T-1	1024071	RTA1-T	17.5	22	1024078
		West NP0052	184T	12.6	1-1/8	208/3	155048	CL02A310T-1	151277	RTA1-P	10.0	16.0	151194
		West NP0052	184T	11.4	1-1/8	240/3	155048	CL01A310T-1	151276	RTA1-P	10.0	16.0	151194
		West NP0052	184T	5.7	1-1/8	480/3	155048	CL00A310T-1	151275	RTA1-L	4.0	6.3	151191
		AOS T59005	184T	4.7	1-1/8	575/3	158170	CL00A310T-1	151275	RTA1-L	4.0	6.3	151191

*Shaft size change: blower motor and replacement blower motor both have a 5/8 inch shaft size (original AOS motor was 1/2 inch). The US T14CA2J9 blower motor requires a starter overload (PN 151192). The Regal Beloit C664 motor replaces US T14CA2J9.

**Starter required: consult the factory-provided wiring diagram or serial number to determine the appropriate starter and overload.

***Shaft size change: replacement motor shaft size is 7/8 inch (original motor was 1-1/8 inch).

NOTE: Energy-efficient (EE) motors listed in Table 16 may not be available. If a functional replacement is required for an EE-type motor, the unit wiring diagram or serial No. will be required.

Table 16. EE-Type Blower Motors by Motor Option and Starter

HP	Option	Blower Motor						Starter (Option AN10)		Starter Overload			
		MFR's Model	Frame Size	Full Load Amps (FLA)	Shaft Size (Inches)	Voltage/Phase	PN	MFR's Model	PN	GE Model	Min Amps	Max Amps	PN
1		West DHP0014	143T	3.1	7/8	208/3	159328	CL00A310T-1	151275	RTA1-K	2.5	4.1	151190
		West DHP0014	143T	2.7	7/8	240/3	159328	CL00A310T-1	151275	RTA1-K	2.5	4.1	151190
		West DHP0014	143T	1.4	7/8	480/3	159328	CL00A310T-1	151275	RTA1-G	1.0	1.5	151187
		AOS H959	N143T	1.1	5/8	575/3	158175	CL00A310T-1	151275	RTA1-G	1.0	1.5	151187
1.5	AL36, AL37, AL38	E104	P145T	4.5	7/8	208/3	105662	CL00A310T-1	151275	RTA1-L	4.0	6.3	151191
		E1016	145T	3.9	7/8	240/3	159329	CL00A310T-1	151275	RTA1-K	2.5	4.1	151190
		E1016	145T	2.0	7/8	480/3	159329	CL00A310T-1	151275	RTA1-J	1.9	2.7	151189
		AOS H960	R145T	1.6	7/8	575/3	158162	CL00A310T-1	151275	RTA1-H	1.3	1.9	151188
2		E105	P145T	6	7/8	208/3	105664	CL00A310T-1	151275	RTA1-L	4.0	6.3	151191
		E1017	145T	5.8	7/8	240/3	159027	CL00A310T-1	151275	RTA1-L	4.0	6.3	151191
		E1017	145T	2.9	7/8	480/3	159027	CL00A310T-1	151275	RTA1-K	2.5	4.1	151190
		AOS H965V1	P145T	2.1	7/8	575/3	158176	CL00A310T-1	151275	RTA1-J	1.9	2.7	151189
3	AL39	B-35L405S489G3	145T	8.3	7/8	208/3	159186	CL00A310T-1	151275	RTA1-N	8.0	12.0	151193
		B-EM3158T	145T	7.4	7/8	240/3	159028	CL00A310T-1	151275	RTA1-N	5.5	8.5	151192
		B-EM3158T	145T	3.7	7/8	480/3	159028	CL00A310T-1	151275	RTA1-K	2.5	4.1	151190
		B-35L405S709G1	145T	3.0	7/8	575/3	159030	CL00A310T-1	151275	RTA1-K	2.5	4.1	151190
5	AL27	E204	H182T	13.9	1-1/8	208/3	159029	CL02A310T-1	151277	RTA1-P	10.0	16.0	151194
		E204	H182T	11.6	1-1/8	240/3	159029	CL01A310T-1	151276	RTA1-P	10.0	16.0	151194
		E204	H182T	5.8	1-1/8	480/3	159029	CL00A310T-1	151275	RTA1-M	5.5	8.5	151192
		BAL-M3613T-5	184T	4.8	1-1/8	575/3	111602	CL00A310T-1	151275	RTA1-L	4.0	6.3	151191

BLOWER MOTORS, CONTACTORS, AND STARTERS—CONTINUED

Table 17. Two-Speed Blower Motors									
Blower Motor*						ABB Starter/Overload Package			
HP	Magnetec No.	Frame Size	Shaft Size (Inches)	Voltage/Phase	PN	MFR's Model	Overload Maximum Amps		Package PN
							Low Speed	High Speed	
1-0.44	M124	M145T	7/8	208/3	105641	A16ST-34J2K	2.4	3.8	222180
	M124	M145T	7/8	240/3	105641	A16ST-80H2K	2.2	3.4	114971
	M109	M145T	7/8	480/3	105642	A16ST-51F2G	1.1	1.7	114972
1.5-0.68	M125	N145T	7/8	208/3	105643	A16ST-34K2M	3.1	5.4	222181
	M125	N145T	7/8	240/3	105643	A16ST-80J2M	2.8	4.9	114973
	M104	N145T	7/8	480/3	105644	A16ST-51G2J	1.4	2.4	114974
2-0.88	M220	S182T	1-1/8	208/3	105645	A16ST-34L2N	4.2	6.5	222182
	M220	S182T	1-1/8	240/3	105645	A16ST-80K2M	3.8	5.9	114976
	M207	S182T	1-1/8	480/3	105646	A16ST-51H2K	2.1	3.4	114977
3-1.3	M221	S184T	1-1/8	208/3	105647	A16ST-34M2P	5.3	9.3	222183
	M221	S184T	1-1/8	240/3	105647	A16ST-80M2P	4.8	8.4	114978
	M208	S184T	1-1/8	480/3	105648	A16ST-51J2L	2.6	4.6	114979

*Options that can be ordered: 1) option AO3 for N.O. auxiliary contacts, ABB model CA6-10, 10A, 600V (PN [115951](#)) and 2) option AO4 for N.C. auxiliary contacts, AEG model HS17.01, 10A, 600V (PN [115952](#)).

VENTER COMPONENTS

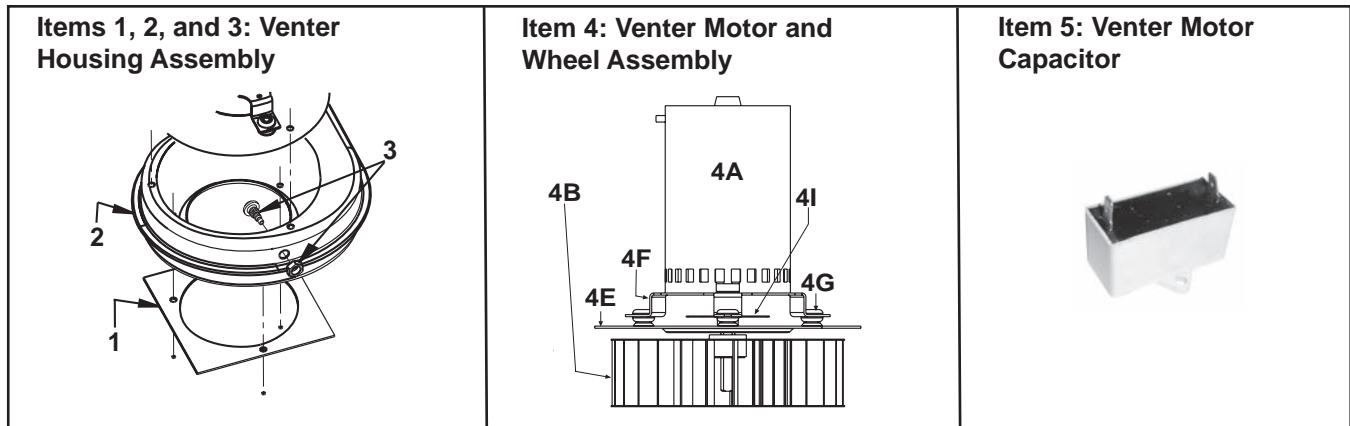


Figure 12. Venter Components—Models PDH, SDH, and RDH (Refer to [Table 18](#))

Table 18. Venter Components (Models PDH, SDH, and RDH)

Item No.	Component	Description	Unit Size			
			75, 100	125, 150	175, 200, 225	250, 300, 350, 400A
			PN (Quantity)*			
1	Gasket	Venter housing	196012		254935 (replaces 196013) ^a	
2	Venter housing	With hole for pressure sensor	196248 ^b		259680 ^b	
			196248 ^a		210929 ^a	
3	Static pressure tap		116043			
4	Venter motor and wheel assembly	115V/1PH	214592	214593	214594	214595
		208/230V/1PH	214596	214597	214599	
		208/230V/3PH				
		460V				
575V						
4A	Venter motor	115V/1PH	262444 ^c	236157	236158	236159
		208/230V/1PH	236160 (replaces 196827)	236161 (replaces 196828)	1012961 (replaces 236162)	1012961 (replaces 236163)
		208/230V/3PH				
		460V				
		575V				
4B	Wheel	5-1/16-inch diameter x 2-inch wide x 5/16-inch inside	135979		—	
		6-5/16-inch diameter x 2-inch wide x 7/16-inch inside	—		195666	
4C	Spacer (not shown)	Isolator bushing, #10 x 0.310	194803 (3)			
4D	Plate (not shown)	Venter motor-mounting	194806		194910	
4E	Gasket	Venter motor plate	—		201472	
4F	Isolator		194534 (3)			
4G	Screw	Isolator	202949 (3)			
4H	Clip (not shown)	Venter motor	196013 (3) ^a			
			194805 (3) ^d			
4I	Bracket	Motor-mounting	195072 ^d			
4J	Fan (not shown)	Cooling	195766		196013 ^a	
					196035 ^e	
5	Venter motor capacitor	115V/1PH, 4µF	—	195641	—	
		115V/1PH, 5µF		—		195642
		115V/1PH, 7.5µF		—	195643	—
		208/230V/1PH, 4µF		195641	—	195641
		208/230V/1PH, 5µF		—	195642	—
		208/230V/3PH, 4µF		195641	—	195641
		208/230V/3PH, 5µF		—	195642	—
		460V and 575V, 4µF		195641	—	195641
460V and 575V, 5µF	—	195642	—			
6	Transformer (not shown)	200VA, 460V and 575V	210862		—	
		350VA, 460V and 575V	—		210863	

*Quantity is one (1) unless otherwise indicated.

^aUsed on units manufactured **before** 22 SEP 2010.

^bUsed on units manufactured **after** 21 SEP 2010.

^cOn units equipped with Broad Ocean motor 1005553, replace with kit 262444.

^dNot needed with Fasco (PNs 236157 through 236163) and Broad Ocean (PNs 1005553 and 1012555) venter motors.

^eNot needed with Broad Ocean (PN 1012555) venter motor.

VENTER COMPONENTS—CONTINUED

NOTE:

Refer to [Figure 13](#) for the following:

- Smooth side of slinger (item 4E) should be flush against the venter motor-mounting plate (item 4B).
- There should be a 1/2-inch (12.7-mm) clearance (see dimension A) between the venter motor-mounting plate (item 4B) and the wheel (item 4F).

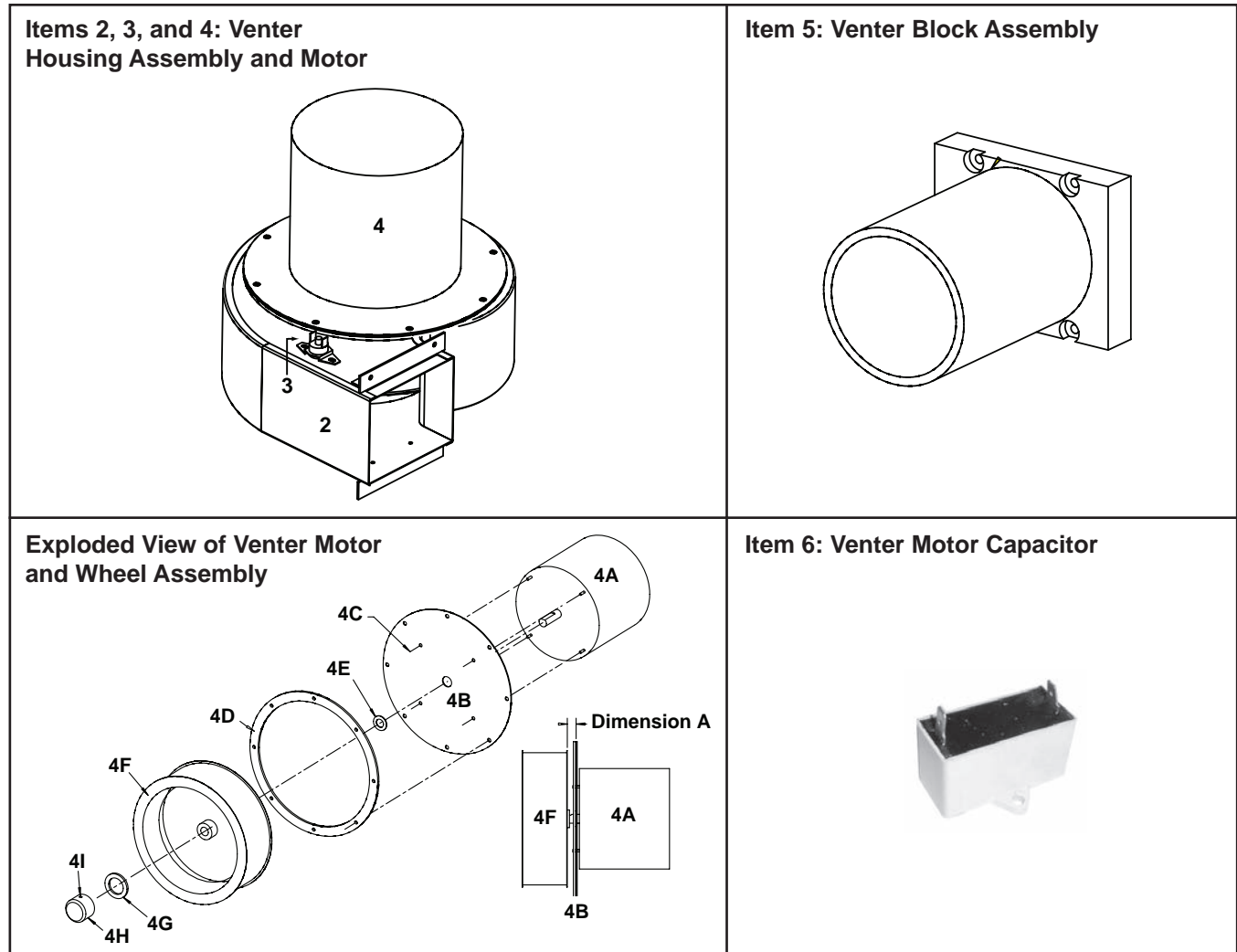


Figure 13. Venter Components—Models SHH and RHH (Refer to [Table 19](#))

Table 19. Venter Components (Models SHH and RHH)				
Item No.	Component	Description	Unit Size	
			130, 180, 260	350
			PN (Quantity)*	
1	Gasket (not shown)	Venter inlet	221164	
2	Venter housing assembly		257470	
3	Limit control	Manual reset	221158	
4	Venter motor and wheel assembly	115V/1PH	221240	257051
		208/230V/1PH		
		208/230V/3PH		
		460V and 575V		
4A	Venter motor		221159	
4B	Plate	Venter motor-mounting	221162	
4C	Nut		221179 (4)	
4D	Gasket	Venter motor plate	221163	
4E	Slinger		221861	
4F	Wheel		221172	222822
4G	Gasket	Shaft protector	221161	
4H	Shaft protector		221160	
4I	Setscrew		222077	
5	Venter block assembly	For connecting vent pipe	221518	
5A	Transformer (item 13 in Table 3), option AK2, AK3, AK4, AK5, AK6, or AK7 (not shown)	350VA, 208/230V/1PH	257032	
		350VA, 208/230V/3PH		
		350VA, 460V/3PH		
	Transformer, option AK8 (not shown)	350 VA, 575V/3PH	257031	
5B	Fuse (not shown)	Time-delay ferrule	257034	
5C	Clip (not shown)	Fuse	257033	
6	Venter motor capacitor	7.5µF	195643	

*Quantity is one (1) unless otherwise indicated.

VENT TERMINAL COMPONENTS

NOTE:

- Vent terminal components for model PDH are shown in [Figure 14](#) and listed in [Table 20](#).
- Vent terminal components for model RDH are shown in [Figure 15](#) and listed in [Table 21](#).
- Vent terminal components for model SDH are shown in [Figure 16](#) and [Figure 17](#) and are listed in [Table 22](#) and [Table 23](#).
- Vent terminal components for model SHH are shown in [Figure 18](#) and [Figure 19](#) and are listed in [Table 24](#) and [Table 25](#).

VENT TERMINAL COMPONENTS—CONTINUED



Figure 14. Vent Cap—Model PDH (Refer to Table 20)

Table 20. Vent Cap (Model PDH)			
Component	Description	Unit Size	PN
Vent cap (same as option CC1)	4-inch	75, 100, 125	111848
	5-inch	150, 175, 200, 225	111849
	6-inch	250, 300, 350, 400A	111850

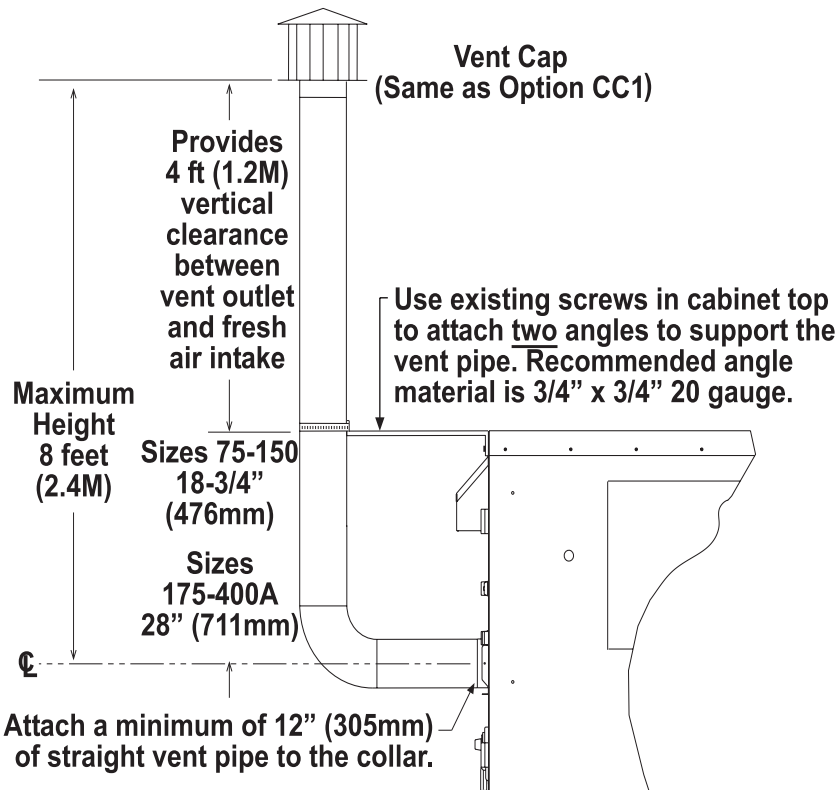


Figure 15. Vent Cap for Vertical Vent—Model RDH (Refer to Table 21)

Table 21. Vent Cap (Model RDH)			
Component	Description	Unit Size	PN
Vent cap (same as option CC1)	4-inch	75, 100, 125, 150	111848
	5-inch	175, 200, 225, 250, 300, 350, 400A	111849



Figure 16. Vertical Vent/Combustion Air Kits—Model SDH (Refer to Table 22)

Item No.	Component	Unit Size		Quantity
		75–125	150–400A	
		PN		
—	Vertical vent/combustion air terminal kit (same as option CC2)	205895	205896	1
1	Concentric adapter box assembly	205884	205885	1
2	Vent terminal assembly	110051	110053	1
3	Combustion air inlet assembly	155635	53330	1
4	Bracket, for attaching concentric adapter box (not shown)	207232		2
5	Sealant, silicone, high temperature, tube (not shown)	53335		1



Figure 17. Horizontal Vent/Combustion Air Kits—Model SDH (Refer to Table 23)

Item No.	Component	Unit Size		Quantity
		75–125	150–400A	
		PN		
—	Horizontal vent/combustion air terminal kit (same as option CC6)	211762	211763	1
1	Concentric adapter box assembly	211789	211790	1
2	Exhaust grill	211791	211792	1
3	Inlet guard	151755	124940	1
4	Screw, #10-16 x 1/2-inch long, for attaching exhaust grill and inlet guard	37661		8
5	Bracket, for attaching concentric adapter box (not shown)	207232		2
6	Sealant, silicone, high temperature, tube (not shown)	53335		1

VENT TERMINAL COMPONENTS—CONTINUED

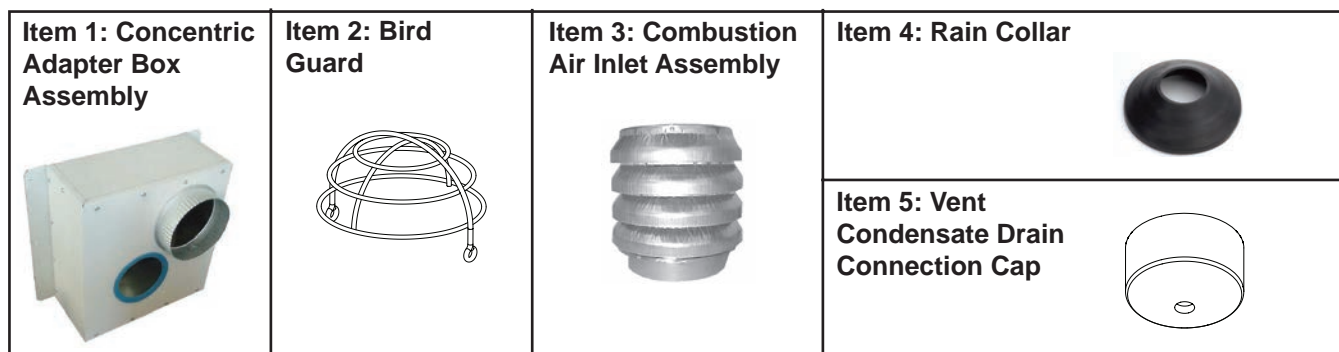


Figure 18. Vertical Vent/Combustion Air Kit—Model SHH (Refer to [Table 24](#))

Table 24. Vertical Vent/Combustion Air Kit (Model SHH)				
Item No.	Component	Unit Size		Quantity
		All		
		PN		
—	Vertical vent/combustion air terminal kit (same as option CC2)	221248		1
1	Concentric adapter box assembly	221069		1
2	Bird guard, for exhaust	221215		1
3	Combustion air inlet assembly	221250		1
4	Rain collar	221185		1
5	Vent condensate drain connection cap, 4-inch PVC	221091		1

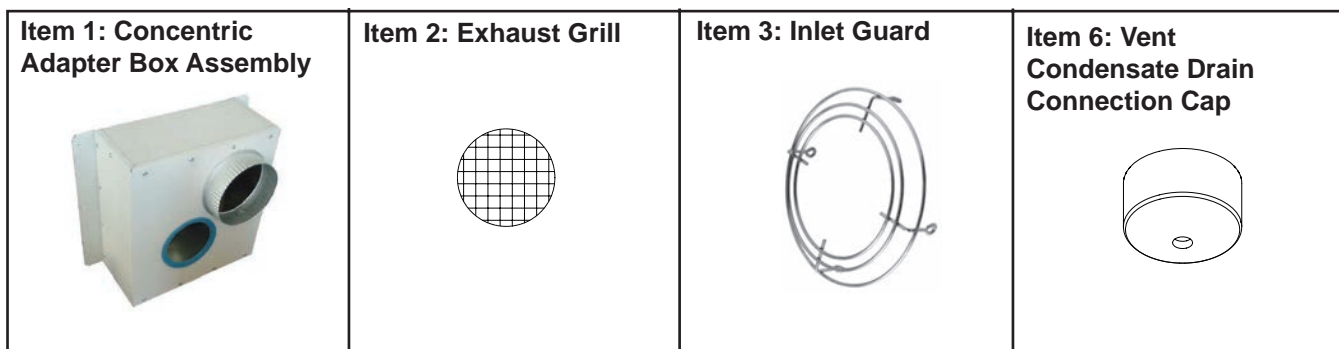


Figure 19. Horizontal Vent/Combustion Air Kit—Model SHH (Refer to [Table 25](#))

Table 25. Horizontal Vent/Combustion Air Kit (Model SHH)				
Item No.	Component	Unit Size		Quantity
		All		
		PN		
—	Horizontal vent/combustion air terminal kit (same as option CC6)	221247		1
1	Concentric adapter box assembly	221069		1
2	Exhaust grill	221089		1
3	Inlet guard	124940		1
4	Screw, #10-16 x 1/2-inch long, for attaching exhaust grill and inlet guard	37661		4
5	Spacer, for inlet guard	221186		2
6	Vent condensate drain connection cap, 4-inch PVC	221091		1

REPLACEMENT HEAT EXCHANGERS

NOTE: Select replacement heat exchanger by material type and left or right side controls.

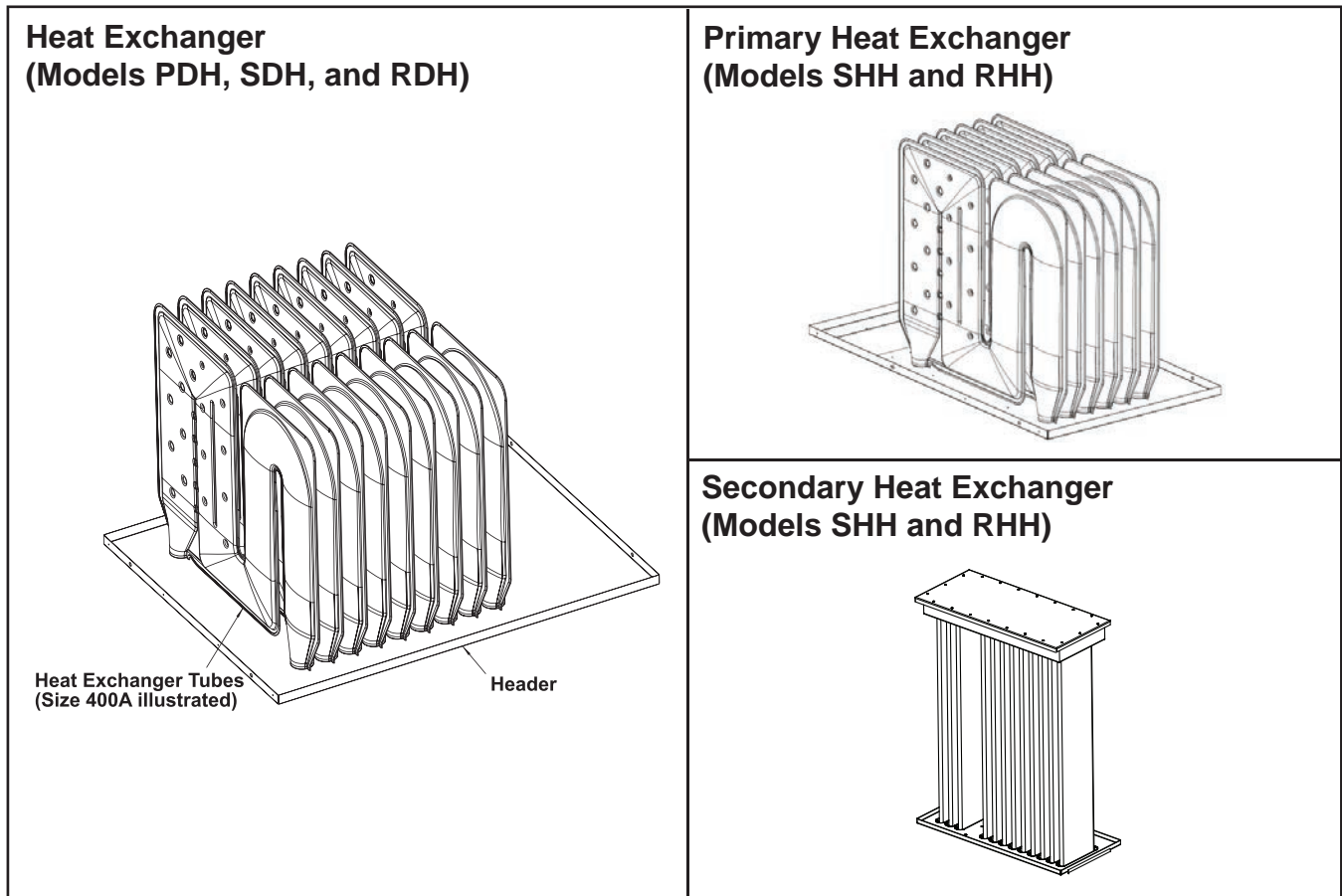


Figure 20. Replacement Heat Exchangers (Refer to Table 26)

Model		Description		Unit Size												
				75	100	125	130	150	175	180	200, 225	250	260	300	350	400A
				PN												
PDH, SDH, RDH	Aluminized (option AC1)*	212030	212031	212032		212033	212034		212035	212036		212037	212038	212039		
	409 SS (option AC2)*	212161	212162	212163		212164	212165		212166	212167		212168	212169	212170		
	316 SS (option AC4)*	212136	212137	212138		212139	212140		212141	212142		212143	212144	212145		
	Aluminized (option AC1)**	212040	212041	212042		212043	212044		212045	212046		212047	212048	212049		
	409 SS (option AC2)**	212171	212172	212173		212174	212175		212176	212177		212178	212179	212180		
	316 SS (option AC4)**	212146	212147	212148		212149	212150		212151	212152		212153	212154	212155		
SHH, RHH	Primary*				271468			271469			271470			271471		
	Primary**				271472			271473			271474			271475		
SHH	Secondary*				257041			255778			255363			254013		
	Secondary**				257953			257954			257955			257956		
RHH	Secondary*				263644			263643			263642			263641		
	Secondary**				263633			263634			263635			263636		

*Control side is left when facing system discharge (option AJ1).
 **Control side is right when facing system discharge (option AJ2).

FLUE COLLECTION BOX, BURNER SHIELD, AND CONDENSATE DRAIN ASSEMBLIES

<p>Flue Collection Box and Burner Shield (Viewed from below Heat Exchanger Header)</p> <p>Models PDH, SDH, and RDH</p> <p>Models SHH and RHH</p>	<p>Item 2: Burner End Shield with Sight Glass</p>
	<p>Condensate Drain Assembly</p> <p>Models PDH, SDH, and RDH</p>
	<p>Item 5: Freeze-Resistant Condensate Drain Trap</p>

Figure 21. Flue Collection Box, Burner Shield, and Condensate Drain Assemblies
(Refer to [Table 27](#) and [Table 28](#))

Table 27. Flue Collection Box Assemblies

Application*	Control Side Facing System Discharge (Option)	Unit Size													
		75	100	125	130	150	175	180	200	225	250	260	300	350	400A
		PN													
Models PFH, SDH, and RDH															
On units with all gas control options EXCEPT option AG58 or D12G (8:1 modulation)	Left (AJ1)**	209855	209856	209857		209858	209859		209860	209861	209862		209863	209864	209865
	Right (AJ2)**	213317	213318	213319	—	213320	213321	—	213322	213323	213324	—	213325	213326	213327
	Left (AJ1)***	209855	209856	209857		209858	260293		260294	260295	260296		260297	260298	260299
	Right (AJ2)***	213317	213318	213319		213320	260307		260308	260309	260310		260311	260312	260313
Model RDH															
On units with 8:1 modulation gas control option AG58 or D12G	Left (AJ1)						260300		260301	260302	260303		260304	260305	260306
	Right (AJ2)						260314		260315	260316	260317		260318	260319	260320
Models RHH and SHH															
On unit sizes 130, 180, 260, and 350	Left (AJ1)				257380			257380				257381		257382	
	Right (AJ2)				257982			257982				257983		257984	
*Flue collection box assembly includes side, end, and venter gaskets.															
**Units manufactured before 22 SEP 2010.															
***Units manufactured after 21 SEP 2010.															

Table 28. Burner Shield and Condensate Drain Assembly Components

Item No.	Description	Control Side Facing System Discharge (Option)	Unit Size										
			75	100	125	150	175	200	225	250	300	350	400A
			PN (Quantity)*										
Models PFH, SDH, and RDH													
1	Burner shield assembly	Left (AJ1)	209816	209817	209820	209821	209816	209817	209817	209818	209819	209821	209822
		Right (AJ2)	213310	213311	213312	213313	213310	213311	213311	213314	213315	213313	213316
2	Burner end shield with sight glass**	Left (AJ1)	260052										
		Right (AJ2)	260054										
3	Condensate drain cover	—	216338 (2)										
	Condensate drain fitting (optional)		216337 (2)										
4	Condensate drain gasket		216339 (2)										
Item No.	Description	Control Side Facing System Discharge (Option)	Unit Size										
			130	180	260	350							
			PN (Quantity)*										
Models RHH and SHH													
1	Burner shield assembly	Left (AJ1)		255798		209816		209819		222394			
		Right (AJ2)		257961		213310		213315		257962			
2	Burner end shield with sight glass**	Left (AJ1)	260052										
		Right (AJ2)	260054										
3	Condensate drain fitting	—	216337 (2)										
4	Condensate drain gasket		216339 (2)										
5	Freeze-resistant condensate drain trap***		271064										
*Quantity is one (1) unless otherwise indicated.													
**Does not include controller or bracket mounted on burner end shield on units with control option AG58 or D12G.													
***Required on model RHH units.													

BURNER COMPONENTS (MODELS PDH, SDH, RDH, SHH, AND RHH)

NOTE: The burner end shield (see [Figure 21](#)) is not shown here. It must be loosened or removed to slide out the burner.

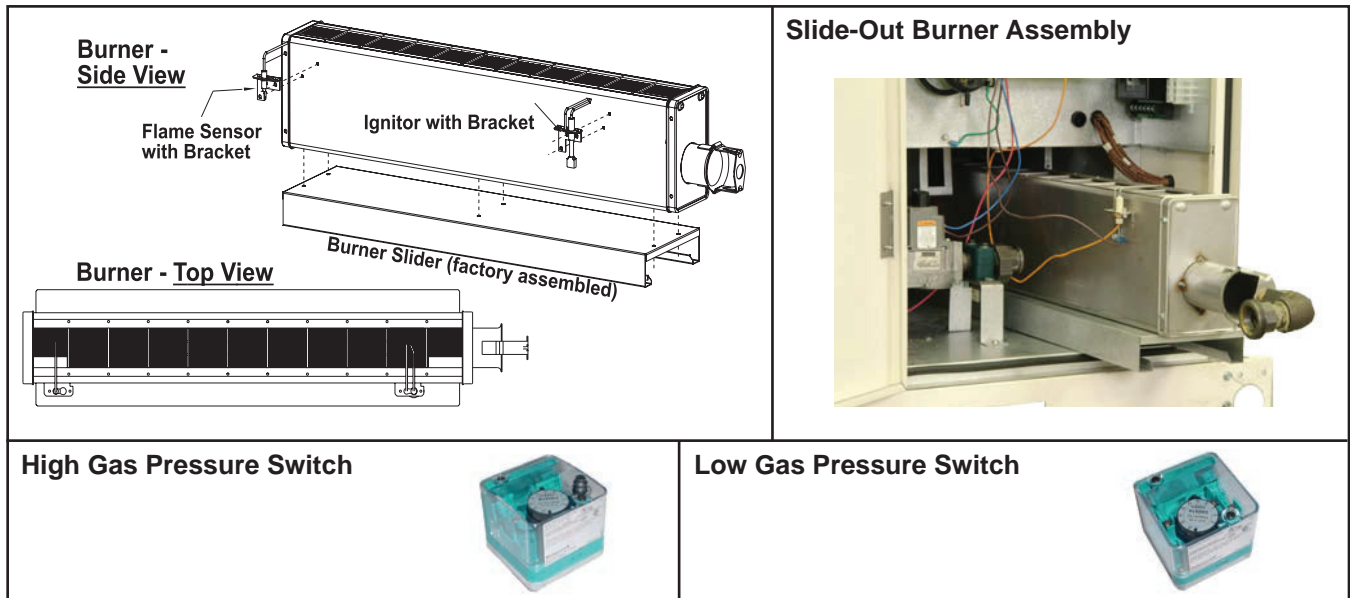


Figure 22. Burner Components (Refer to [Table 29](#))

Table 29. Burner Components											
Component	Unit Size										
	75	100	125	150	175	200	225	250	300	350	400A
PN											
Models PDH, SDH, and RDH											
Burner assembly, slide-out	211805	211806	211807	211808	260057	260058	260059	260060	260061	260062	
Bushing, orifice adapter	165701						194809				
Primary air restrictor, propane	202051				196688		—				
Component	Unit Size										
	130		180		260		350				
PN											
Models RHH and SHH											
Burner assembly, slide-out	257027			211809			211812			257028	
Bushing, orifice adapter	165701						194809				
Primary air restrictor, propane	196688				—						
Component	Description	All Unit Sizes									
		PN (Quantity)*									
Models PDH, SDH, RDH, RHH, and SHH											
Ignitor (electrode)						209339					
Flame sensor	Part of burner assembly					209973					
Bracket, ignitor and flame sensor						209989 (2)					
Pipe nut	1/2-inch					165702					
Gas pressure switch	High pressure, manual reset (option BP2 and part of option BP4)					204297					
	Low pressure, auto reset (option BP3 and part of option BP4)					204375					
Gas orifice	Refer to Table 30										
NOTE: Replacement gas valve PNs are identified by serial No. (refer to form P-VALVES listed in Table 1). For replacement gas pressure switch used with deep modulation gas control, refer to item 28 in Table 3 .											
*Quantity is one (1) unless otherwise indicated.											

Model	Unit Size	Natural Gas		Propane	
		Orifice (Drill) Size	PN	Orifice (Drill) Size	PN
PDH, RDH, SDH	75	#19	196855	#39	196852
	100	#11	205430	2.9-mm	205720
	125	#3	211851	#30	196838
	150	5.9-mm	131581	9/64-inch	196898
	175	E	196891	#24	196899
	200	6.8-mm	196892	4.1-mm	196900
	225	6.95-mm	221121	11/64-inch	196901
	250	L	208255	#14	196902
	300	8.0-mm	221122	#8	196903
	350	8.7-mm	221123	#3	196904
	400A	9.6-mm	196897	5.8-mm	196905
RHH, SHH	130	#3	211851	3.3-mm	120145
	180	6.2-mm	221263	#24	196899
	260	7.6-mm	196894	#14	196902
	350	11/32-inch	206913	#3	196904

GAS CONVERSION KITS

NOTE: These gas conversion kits apply only to models PDH, SDH, and RDH with single- or two-stage gas control option AG1, AG2, AG3, AG15, or AG16. Do not use these conversion kits with any other gas control option. If gas conversion is required, contact your distributor or the factory. Refer to form CP-PREEVA-GC listed in [Table 1](#) for a list of component parts and instructions.

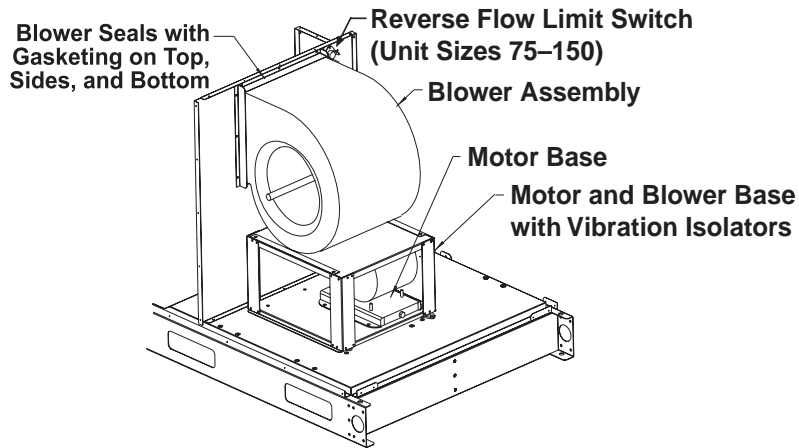
Conversion Type	Unit Size				
	75, 100	125, 150	175, 200, 225	250, 300	350, 400A
Natural gas to propane	269846	269847	269848	212067	212068
Propane to natural gas	269860	269861	269862	212072	212073

BLOWER COMPONENTS

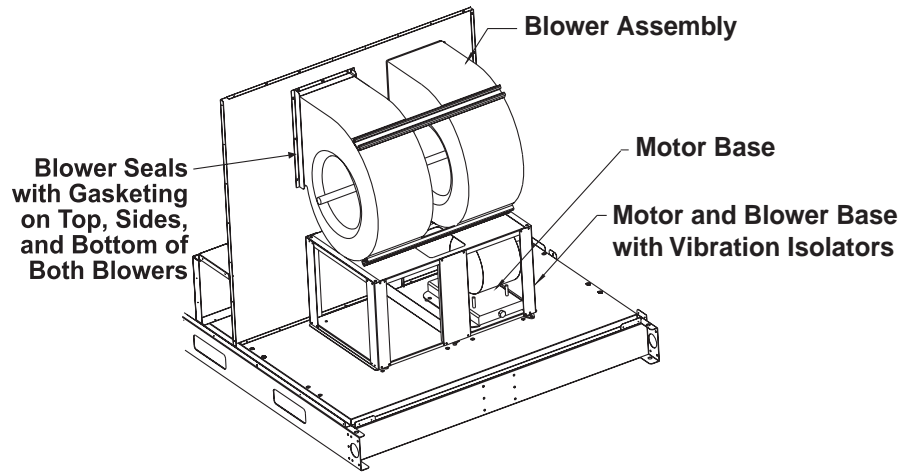


Figure 23. Blower Section

BLOWER COMPONENTS—CONTINUED

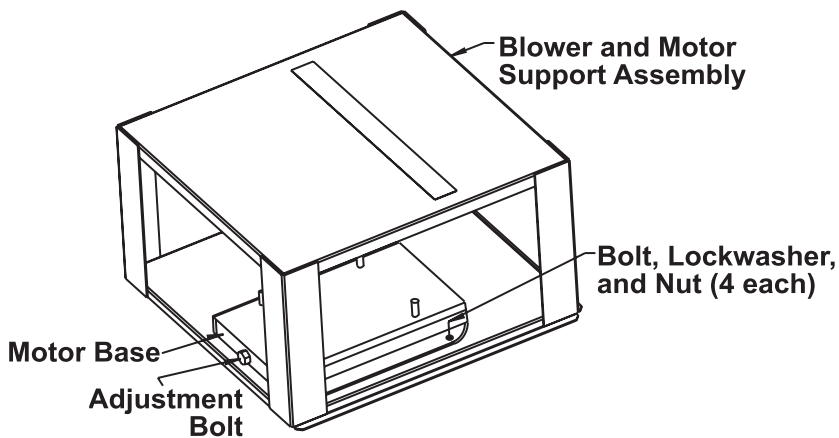


Single Blower Assembly (Unit Sizes 75, 100, 175, 200, and 225)



Twin Blower Assembly (Unit Sizes 125, 150, 250, 300, 350, and 400A)

Motor Mounting



Spring Vibration Isolator



Figure 24. Blower Components (Refer to [Table 32](#) and [Table 33](#))

Component	Models PDH, RDH, and SDH	Unit Size					
		75, 100	125, 150	175, 200, 225	250, 300	350, 400A	
		Models PEH and REH	10A, 20A, 40A	15B, 30B, 60B	—	30D, 60D, 90D, 120D	40E, 80E, 120E
		Models PXH and RXH	000A	000B	000C	000D	000E
	Models RHH and SHH	—		130, 180	260	350	
Description		PN (Quantity)*					
Blower assembly	Single, 10 x 10 inches	210856	—				
	Twin, 9 x 7 inches	—	210857	—			
	Single, 12 x 12 inches	—		1360	—		
	Twin, 12 x 7 inches	—			210859	—	
	Twin, 12 x 12 inches	—				210860	
Bearing	Blower, part of blower assembly	10437 (2)	214294 (2)	10437 (2)	10437 (2)	214294 (2)	
Blower shaft, part of blower assembly	1 x 18.7 inches	214295	—				
	1 x 30.4 inches	—	214297	—			
	1 x 22 inches	—		11303	—		
	1 x 30.4 inches	—			214297	—	
	1 x 42.5 inches	—				214298	
Sensing tube	Assembly, not shown	111733					
Base	Motor	Refer to Table 33					
Vibration isolator, motor tray	Rubber, standard (cabinets A, B, C)	210861 (4)					
	Rubber, standard (cabinets D, E)	210861 (6)					
	Spring (option PC13) (cabinets A, B, C)	216476 (4)					
	Spring (option PC13) (cabinets D, E)	216476 (6)					

*Quantity is one (1) unless otherwise indicated.

Frame Size*	Motor Base PN	Hardware		
		Bolt	Lockwasher	Nut
		PN (Quantity)		
48	213587	16427 (4)	1333 (4)	1035 (4)
56	208380			
143	208381			
145	208382	16247 (4)	15119 (4)	15117 (4)
182	208383			
184	208384	16251 (4)		

*Refer to [Table 14](#), [Table 15](#), and [Table 16](#).

DRIVE COMPONENTS (PULLEYS AND BELTS)

NOTE:

- **Drive Components:** Drive components are listed by available motor (AL) option. Drives for units with two-speed motors (option AL45, AL46, AL47, or AL48) are not listed. If drive components are needed for a two-speed motor, check with the factory.
- **Blower Pulleys:** If an H x 1-inch bushing is required, order PN [92203](#).
- **Linked Belts:** Drives listed in this section have linked belts. Assume 17 Fenner “A” or “B” belt links per foot. Linked belt PNs [201809](#) and [202655](#) are each for 1 foot of belt. Refer to [Table 35](#), [Table 36](#), or [Table 37](#) for the quantity required.
- **Solid Belts:** If a solid belt is required, provide the factory with a center line measurement to order a replacement.

DRIVE COMPONENTS (PULLEYS AND BELTS)—CONTINUED

Option	Range (rpm)	Option	Range (rpm)	Option	Range (rpm)
AM1, EM1	401–450	AM11, EM11	901–950	AM21, EM21	1401–1450
AM2, EM2	451–500	AM12, EM12	951–1000	AM22, EM22	1451–1500
AM3, EM3	501–550	AM13, EM13	1001–1050	AM23, EM23	1501–1550
AM4, EM4	551–600	AM14, EM14	1051–1100	AM24, EM24	1551–1600
AM5, EM5	601–650	AM15, EM15	1101–1150	AM25, EM25	1601–1650
AM6, EM6	651–700	AM16, EM16	1151–1200	AM26, EM26	1651–1700
AM7, EM7	701–750	AM17, EM17	1201–1250	AM27, EM27	1701–1750
AM8, EM8	751–800	AM18, EM18	1251–1300	AM28, EM28	1751–1800
AM9, EM9	801–850	AM19, EM19	1301–1350	AM29, EM29	1801–1850
AM10, EM10	851–900	AM20, EM20	1351–1400	AM30, EM30	1851–1900

HP	Motor			Motor Pulley			Blower Pulley			Belt
	Motor (AL) Option	Voltage Option (Voltage/PH)	Drive (AM/EM) Option (Refer to Table 34)	PN	Model	Bore Size (Inches)	PN	Model	Bore Size (Inches)	PN (Quantity)
1/4, 1/3	2, 3	AK1 (115/1), AK2 (208/1), AK3 (230/1), AK5 (208/3), AK6 (230/3), AK7 (460/3)	1, 2	4074	1VL34	1/2	111609	AK99	1	201809 (3.8 feet)
			3, 4	13491	1VL40		111609	AK99		
			5, 6, 7	13491	1VL40		19111	AK84		
			8, 9, 10, 11, 12	13491	1VL40		18797	AK64		
			13, 14, 15, 16, 17	13491	1VL40		135200	AK51		
1/2, 3/4, 1, 1-1/2	4, 5, 6, 7	AK1 (115/1), AK2 (208/1), AK3 (230/1), AK5 (208/3), AK6 (230/3), AK7 (460/3)	1, 2	13580	1VL34	5/8	111609	AK99	1	201809 (3.8 feet)
			3, 4	7962	1VL40		111609	AK99		
			5, 6, 7	7962	1VL40		19111	AK84		
			8, 9, 10, 11, 12	7962	1VL40		18797	AK64		
			13, 14, 15, 16, 17	7962	1VL40		135200	AK51		
			18, 19, 20, 21, 22, 23, 24, 25	105476	1VL44		206125	AK44		
1/2, 3/4	4, 5	AK8 (575/3)	1, 2	13580	1VL34	5/8	111609	AK99	1	201809 (3.8 feet)
			3, 4	7962	1VL40		111609	AK99		
			5, 6, 7	7962	1VL40		19111	AK84		
			8, 9, 10, 11, 12	7962	1VL40		18797	AK64		
			13, 14, 15, 16, 17	7962	1VL40		135200	AK51		
			18, 19, 20, 21, 22, 23, 24, 25	105476	1VL44		206125	AK44		
1, 1-1/2	6, 7	AK8 (575/3)	1, 2	110125	1VP34	7/8	111609	AK99	1	201809 (3.8 feet)
			3, 4	106748	1VL40		111609	AK99		
			5, 6, 7	106748	1VL40		19111	AK84		
			8, 9, 10, 11, 12	106748	1VL40		18797	AK64		
			13, 14, 15, 16, 17	106748	1VL40		135200	AK51		
			18, 19, 20, 21, 22, 23, 24, 25	106758	1VL44		206125	AK44		
2	8	AK1 (115/1), AK2 (208/1), AK3 (230/1), AK8 (575/3)	1, 2	13580	1VL34	5/8	111609	AK 99	1	201809 (3.8 feet)
			3, 4	7962	1VL40		111609	AK 99		
			5, 6, 7	7962	1VL40		19111	AK84		
			8, 9, 10, 11, 12	7962	1VL40		18797	AK64		
			13, 14, 15, 16, 17	7962	1VL40		135200	AK51		
			18, 19, 20, 21, 22, 23, 24, 25	105476	1VL44		206125	AK44		
			26, 27, 28, 29	105476	1VL44		135201	AK39		
	8	AK5 (208/3), AK6 (230/3), AK7 (460/3)	1, 2	110125	1VP34	7/8	111609	AK 99	1	201809 (3.8 feet)
			3, 4	106748	1VL40		111609	AK 99		
			5, 6, 7	106748	1VL40		19111	AK 84		
			8, 9, 10, 11, 12	106748	1VL40		18797	AK 64		
			13, 14, 15, 16, 17	106748	1VL40		135200	AK 51		
			18, 19, 20, 21, 22, 23, 24, 25	106758	1VL44		206125	AK44		
			26, 27, 28, 29	106758	1VL44		135201	AK39		

Table 35. Drive Components (Open-Type Motors)—Continued

Motor			Motor Pulley			Blower Pulley			Belt	
HP	Motor (AL) Option	Voltage Option (Voltage/PH)	Drive (AM/EM) Option (Refer to Table 34)	PN	Model	Bore Size (Inches)	PN	Model	Bore Size (Inches)	PN (Quantity)
3	9	AK2 (208/1), AK3 (230/1)	8, 9, 10, 11, 12	7962	1VL40	5/8	202652	AK124	1	201809 (3.8 feet)
			13, 14, 15, 16, 17	7962	1VL40		202653	AK94		
3, 5	9, 10	AK5 (208/3), AK6 (230/3), AK7 (460/3), AK8 (575/3)	8, 9, 10, 11, 12	106748	1VL40	7/8	101414	BK130	1	202655 (3.8 feet)
			13, 14, 15, 16, 17	106748	1VL40		202654	BK105		
			18, 19, 20, 21, 22	37451	1VM50		16153	AK104		
			23, 24, 25, 26, 27, 28, 29	37451	1VM50		19111	AK84		
			30, 31, 32, 33, 34, 35, 36	37451	1VM50		105483	AK69		
										201809 (7.6 feet)

Table 36. Drive Components (TEFC-Type Motors)

Motor			Motor Pulley			Blower Pulley			Belt						
HP	Motor (AL) Option	Voltage Option (Voltage/PH)	Drive (AM/EM) Option (Refer to Table 34)	PN	Model	Bore Size (Inches)	PN	Model	Bore Size (Inches)	PN (Quantity)					
1/4	19	AK1 (115/1)	1, 2	4074	1VL34	5/8	111609	AK99	1	201809 (3.8 feet)					
			3, 4	13491	1VL40		111609	AK99							
			5, 6, 7	13491	1VL40		19111	AK84							
			8, 9, 10, 11, 12	13491	1VL40		18797	AK64							
			13, 14, 15, 16, 17	13491	1VL40		135200	AK51							
			1, 2	13580	1VL34		111609	AK 99							
		3, 4	7962	1VL40	111609		AK 99								
		5, 6, 7	7962	1VL40	19111		AK 84								
		8, 9, 10, 11, 12	7962	1VL40	18797		AK 64								
		13, 14, 15, 16, 17	7962	1VL40	135200		AK 51								
		18, 19, 20, 21, 22, 23, 24, 25	105476	1VL44	206125		AK 44								
		26, 27, 28, 29	105476	1VL44	135201		AK 39								
		1/3	20	AK1 (115/1), AK2 (208/1), AK3 (230/1), AK5 (208/3), AK6 (230/3), AK7 (460/3)	1, 2		4074	1VL34			1/2	111609	AK99	1	201809 (3.8 feet)
					3, 4		13491	1VL40				111609	AK99		
5, 6, 7	13491				1VL40	19111	AK84								
8, 9, 10, 11, 12	13491				1VL40	18797	AK64								
13, 14, 15, 16, 17	13491				1VL40	135200	AK51								
1, 2	13580				1VL34	111609	AK 99								
1/2, 3/4, 1	21, 22, 23	AK1 (115/1), AK2 (208/1), AK3 (230/1), AK5 (208/3), AK6 (230/3), AK7 (460/3), AK8 (575/3)	3, 4	7962	1VL40	5/8	111609	AK 99	1	201809 (3.8 feet)					
			5, 6, 7	7962	1VL40		111609	AK 99							
			8, 9, 10, 11, 12	7962	1VL40		19111	AK 84							
			13, 14, 15, 16, 17	7962	1VL40		18797	AK 64							
			18, 19, 20, 21, 22, 23, 24, 25	105476	1VL44		135200	AK 51							
			26, 27, 28, 29	105476	1VL44		206125	AK 44							
			1, 2	13580	1VL34		194296	AK 39							
			3, 4	7962	1VL40		111609	AK 99							
1-1/2	24	AK1 (115/1), AK2 (208/1), AK3 (230/1), AK5 (208/3), AK6 (230/3), AK7 (460/3)	5, 6, 7	7962	1VL40	5/8	11609	AK 99	1	201809 (3.8 feet)					
			8, 9, 10, 11, 12	7962	1VL40		19111	AK 84							
			13, 14, 15, 16, 17	7962	1VL40		18797	AK 64							
			18, 19, 20, 21, 22, 23, 24, 25	105476	1VL44		135200	AK 51							
			26, 27, 28, 29	105476	1VL44		206125	AK 44							
			1, 2	110125	1VP34		135201	AK 39							
1-1/2	24	AK8 (575/3)	3, 4	106748	1VL40	7/8	111609	AK 99	1	201809 (3.8 feet)					
			5, 6, 7	106748	1VL40		11609	AK 99							
			8, 9, 10, 11, 12	106748	1VL40		19111	AK 84							
			13, 14, 15, 16, 17	106748	1VL40		18797	AK 64							
			18, 19, 20, 21, 22, 23, 24, 25	106758	1VL44		135200	AK 51							
			26, 27, 28, 29	106758	1VL44		206125	AK 44							
							135201	AK 39							

DRIVE COMPONENTS (PULLEYS AND BELTS)—CONTINUED

Table 36. Drive Components (TEFC-Type Motors)—Continued											
HP	Motor			Motor Pulley			Blower Pulley			Belt	
	Motor (AL) Option	Voltage Option (Voltage/PH)	Drive (AM/EM) Option (Refer to Table 34)	PN	Model	Bore Size (Inches)	PN	Model	Bore Size (Inches)	PN (Quantity)	
2	25	AK3 (230/1), AK5 (208/3), AK6 (230/3), AK7 (460/3), AK8 (575/3)	1, 2	110125	1VP34	7/8	111609	AK 99	1	201809 (3.8 feet)	
			3, 4	106748	1VL40		111609	AK 99			
			5, 6, 7	106748	1VL40		19111	AK 84			
			8, 9, 10, 11, 12	106748	1VL40		18797	AK 64			
			13, 14, 15, 16, 17	106748	1VL40		135200	AK 51			
			18, 19, 20, 21, 22, 23, 24, 25	106758	1VL44		206125	AK44			
			26, 27, 28, 29	106758	1VL44		135201	AK39			
3	26	AK1 (115/1), AK3 (230/1)	9, 10, 11, 12	7963	2VP42	1-1/8	30621	2AK124	1	201809 (7.6 feet)	
			13, 14, 15, 16, 17	111681	1VP50		223401	2AK124	1-13/16		
			18, 19, 20, 21, 22	161444	1VP56		202652	AK124	1		
			23, 24, 25, 26, 27, 28, 29	111681	1VP50		16156	AK124	1-13/16		
			30, 31, 32, 33, 34, 35, 36	111681	1VP50		202652	AK124	1		
			9, 10, 11, 12	106748	1VL40		16156	AK124	1-13/16		
			13, 14, 15, 16, 17	106748	1VL40		19111	AK84	1		
			18, 19, 20, 21, 22	37451	1VM50		111862	AK84	1-13/16		
			23, 24, 25, 26, 27, 28, 29	37451	1VM50		105783	AK69	1		
			30, 31, 32, 33, 34, 35, 36	37451	1VM50		105484	AK71H	1-13/16		
	5	27	AK5 (208/3), AK6 (230/3), AK7 (460/3), AK8 (575/3)	9, 10, 11, 12	106748	1VL40	7/8	101414	BK130	1	202655 (3.8 feet)
				13, 14, 15, 16, 17	106748	1VL40		202654	BK105		
				18, 19, 20, 21, 22	37451	1VM50		16153	AK104		
				23, 24, 25, 26, 27, 28, 29	37451	1VM50		19111	AK84		
5	27	AK3 (230/1), AK5 (208/3), AK6 (230/3), AK7 (460/3), AK8 (575/3)	9, 10, 11, 12	7963	2VP42	1-1/8	30621	2AK124	1	201809 (3.8 feet)	
			13, 14, 15, 16, 17	111681	1VP50		223401	2AK124	1-13/16		
			18, 19, 20, 21, 22	161444	1VP56		202652	AK124	1		
			23, 24, 25, 26, 27, 28, 29	111681	1VP50		16156	AK124	1-13/16		
			30, 31, 32, 33, 34, 35, 36	111681	1VP50		202652	AK124	1		
			9, 10, 11, 12	106748	1VL40		16156	AK124	1-13/16		
			13, 14, 15, 16, 17	106748	1VL40		19111	AK84	1		
			18, 19, 20, 21, 22	37451	1VM50		111862	AK84	1-13/16		
			23, 24, 25, 26, 27, 28, 29	37451	1VM50		105783	AK69	1		
			30, 31, 32, 33, 34, 35, 36	37451	1VM50		105484	AK71H	1-13/16		

Table 37. Drive Components (EE-Type Motors)										
HP	Motor			Motor Pulley			Blower Pulley			Belt
	Motor (AL) Option	Voltage Option (Voltage/PH)	Drive (AM/EM) Option (Refer to Table 34)	PN	Model	Bore Size (Inches)	PN	Model	Bore Size (Inches)	PN (Quantity)
1, 1-1/2, 2	36, 37, 38	AK5 (208/3), AK6 (230/3), AK7 (460/3), AK8 (575/3)	1, 2	110125	1VP34	7/8	111609	AK 99	1	201809 (3.8 feet)
			3, 4	106748	1VL40		111609	AK 99		
			5, 6, 7	106748	1VL40		19111	AK 84		
			8, 9, 10, 11, 12	106748	1VL40		18797	AK 64		
			13, 14, 15, 16, 17	106748	1VL40		135200	AK 51		
			18, 19, 20, 21, 22, 23, 24, 25	106758	1VL44		206125	AK44		
			26, 27, 28, 29	106758	1VL44		135201	AK39		
3	39	AK5 (208/3), AK6 (230/3), AK7 (460/3), AK8 (575/3)	9, 10, 11, 12	106748	1VL40	7/8	101414	BK130	1	202655 (3.8 feet)
			13, 14, 15, 16, 17	106748	1VL40		202654	BK105		
			18, 19, 20, 21, 22	37451	1VM50		16153	AK104		
			23, 24, 25, 26, 27, 28, 29	37451	1VM50		19111	AK84		
			30, 31, 32, 33, 34, 35, 36	37451	1VM50		105483	AK69		

Motor			Motor Pulley			Blower Pulley			Belt	
HP	Motor (AL) Option	Voltage Option (Voltage/PH)	Drive (AM/EM) Option (Refer to Table 34)	PN	Model	Bore Size (Inches)	PN	Model	Bore Size (Inches)	PN (Quantity)
5	27	AK5 (208/3), AK6 (230/3), AK7 (460/3), AK8 (575/3)	9, 10, 11, 12	7963	2VP42	1-1/8	30621	2AK124	1	201809 (7.6 feet)
							223401	2AK124	1-13/16	
			13, 14, 15, 16, 17	111681	1VP50	1-1/8	202652	AK124	1	201809 (3.8 feet)
							16156	AK124	1-13/16	
			18, 19, 20, 21, 22	161444	1VP56	1-1/8	202652	AK124	1	
							16156	AK124	1-13/16	
			23, 24, 25, 26, 27, 28, 29	111681	1VP50	1-1/8	19111	AK84	1	
							111862	AK84	1-13/16	
			30, 31, 32, 33, 34, 35, 36	111681	1VP50	1-1/8	105783	AK69	1	
							105484	AK71H	1-13/16	

COOLING COIL CABINET COMPONENTS

NOTE:

- Factory-installed cooling coil module applies to all models with option AU5, AU6, or AU7.
- The control side is determined when facing the system discharge. AJ1 = left side controls (see Figure 25). AJ2 = right side controls.

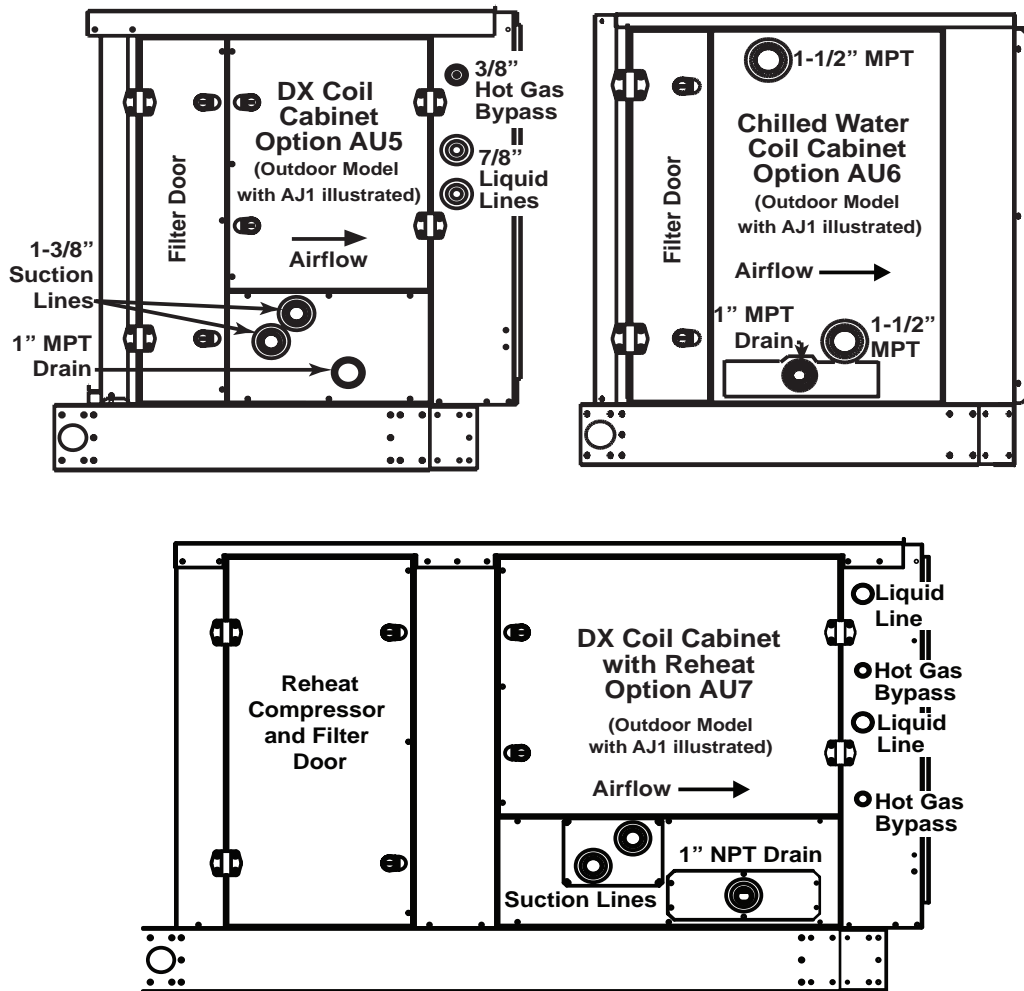


Figure 25. Cooling Coil Cabinets

COOLING COIL CABINET COMPONENTS—CONTINUED

NOTE:

- Replacement parts listed in [Table 38](#) for indoor DX cooling coil cabinets apply to cabinets manufactured *after* OCT 2009 (serial No. date code *B/K*). For replacement parts for cooling coil cabinets manufactured *before* NOV 2009, contact the factory.
- If a replacement cooling coil is needed, contact your distributor.

Table 38. Indoor DX Cooling Coil Cabinet (Option AU5) Components

Component	Models PDH and SDH	Unit Size						
		75, 100	125, 150	175, 200, 225	250, 300	350, 400A		
		Model PEH	10A, 20A, 40A	15B, 30B, 60B	—	30D, 60D, 90D, 120D	40E, 80E, 120E	
		Model PXH	000A	000B	000C	000D	000E	
Model SHH		—		130, 180	260	350		
Description		Control Side*	PN (Quantity)**					
Bottom	AJ1, AJ2		211335	211336	211335	211337	211338	
Front corner	Control side, with connection openings	AJ1	211344		211345			
		AJ2	211405		211406			
	Non-control side, no holes in corner	AJ1	211346		211347			
		AJ2	211407		211854			
Rear corner	Control side	AJ1, AJ2	210054		210055			
	Non-control side		210974		210975			
Liner	For control side front corner	AJ1	220918		220920			
		AJ2	220919		220921			
	Non-control front corner	AJ1, AJ2	220923		220924			
	Rear corner (left and right)		210773 (2)		210774 (2)			
	Top center side panel		211363		211364			
	Bottom center left side panel liner		AJ1	211361		211362		
	AJ2	211855		211856				
Connector	Front corner	AJ1, AJ2	211120 (2)		211121 (2)			
Angle	Bottom filter rack		210080	210081	210080	210082	210083	
Filter track	Bottom		210084	210085		—		
	Assembly, top		210873	210874				
Filter rack	Assembly		—		210870	210871	210872	
Drain pan	Assembly, removable		258496	259190	258496	258497	258498	
Panel	Top center side outer		211369		211370			
	Bottom center side, with suction line connection openings		AJ1	211367		211368		
			AJ2	211859		211860		
Plate	Drain		AJ1, AJ2	211389				
Grommet	2-1/2	220922 (2)						
	1-1/4	220917 (2)						
	3/4	220545 (2)						
	Drain	208002						
Door assembly	Filter, includes latches and hinges	211374		211376				
	Coil, non-control side, includes latches and hinges	211378		211380				
Top	Cooling cabinet assembly	211390		211391	211390	211392	211393	

*AJ1 = left side controls (when facing system discharge) and AJ2 = right side controls.

**Quantity is one (1) unless otherwise indicated.

NOTE:

- Replacement parts listed in **Table 39** for indoor CW cooling coil cabinets apply to cabinets manufactured *after* OCT 2009 (serial No. date code *BIK*). For replacement parts for cooling coil cabinets manufactured *before* NOV 2009, contact the factory.
- If a replacement cooling coil is needed, contact your distributor.

Table 39. Indoor CW Cooling Coil Cabinet (Option AU6) Components

Component	Models PDH and SDH		Unit Size					
			75, 100	125, 150	175, 200, 225	250, 300	350, 400A	
	Model PEH		10A, 20A, 40A	15B, 30B, 60B	—	30D, 60D, 90D, 120D	40E, 80E, 120E	
	Model PXH		000A	000B	000C	000D	000E	
	Model SHH		—		130, 180	260	350	
Description		Control Side*	PN (Quantity)**					
Bottom			211335	211336	211335	211337	211338	
Front corner	Left	AJ1, AJ2	211407		211854			
	Right		211346		211347			
Rear corner	Left		210054		210055			
	Right		210974		210975			
Liner	Front corner post		220923 (2)		220924 (2)			
	Rear corner (left and right)		210773 (2)		210774 (2)			
Connector	Front corner		211120 (2)		211121 (2)			
Angle	Bottom filter rack			210080	210081	210080	210082	210083
	Bottom			210084	210085	—		
Filter track	Assembly, top			210873	210874	—		
	Assembly			—		210870	210871	210872
Filter rack	Assembly			—		210870	210871	210872
Drain pan	Assembly, removable			258496	259190	258496	258497	258498
Panel	Center side, outer, with pipe connection openings		AJ1	211371		211372		
		AJ2	211861		211862			
Liner	Center side panel	AJ1	211365		211366			
		AJ2	211857		211858			
Plate	Drain		211389					
Grommet	1-7/8		215292 (2)					
	Drain		208002					
Filter door	Assembly, includes latches and hinges	AJ1, AJ2	211374		211376			
Coil door	Assembly, non-control side, includes latches and hinges		211378		211380			
Top	Cooling cabinet assembly		211390	211391	211390	211392	211393	

*AJ1 = left side controls (when facing system discharge) and AJ2 = right side controls.

**Quantity is one (1) unless otherwise indicated.

COOLING COIL CABINET COMPONENTS—CONTINUED

NOTE:

- Replacement parts listed in [Table 40](#) for outdoor DX cooling coil cabinets apply to cabinets manufactured *after* SEP 2008 (serial No. date code *BHJ*). For replacement parts for cooling coil cabinets manufactured *before* OCT 2008, contact the factory.
- If a replacement cooling coil is needed, contact your distributor.

Table 40. Outdoor DX Cooling Coil Cabinet (Option AU5) Components

Component	Description	Control Side*	Unit Size					
			Model RDH	75, 100	125, 150	175, 200, 225	250, 300	350, 400A
			Model REH	10A, 20A, 40A	15B, 30B, 60B	—	30D, 60D, 90D, 120D	40E, 80E, 120E
			Model RXH	000A	000B	000C	000D	000E
		Model RHH	—		130, 180	260	350	
		PN (Quantity)**						
Bottom		AJ1	222933	222934	222933	222935	222936	
		AJ2	256184	256185	256184	256186	256187	
Panel	Outer inlet end, not used with mixing box or evaporative cooler	AJ1	214133	214134	214135	214136	214137	
		AJ2	215421	215422	215423	215424	215425	
	Inner inlet end	AJ1	214126	214127	214128	214129	214130	
		AJ2	215414	215415	215416	215417	215418	
Wall	Outer, solid, non-control side	AJ1	214349		214350			
		AJ2	215517		215518			
	Inner, solid	AJ1	222937		222938	222971		
		AJ2	256188		256189	256189		
Front corner	Outer control side, with connection openings	AJ1	222961		222968			
		AJ2	256216		256217			
Post	For control side front corner	AJ1	222960		222967			
		AJ2	256190		256191			
Connector	Front corner	AJ1, AJ2	211120 (2)		211121 (2)			
Drain pan	Assembly, removable	AJ1	222950	222965	222950	222974	222977	
		AJ2	256222	256223	256222	256224	256225	
Channel	Drain pan, assembly	AJ1	222940	222963	222940	222973	222976	
		AJ2	256218	256219	256218	256220	256221	
Filter track	Bottom	AJ1, AJ2	210084	210085	—			
Angle	Filter rack		210080	210081				
Filter track	Top, assembly		210873	210874				
Filter rack	Assembly		—		210870	210871	210872	
Grommet	2-1/2		220922 (2)					
	1-1/4	220917 (2)						
	3/4	220545 (2)						
	Drain	208002						
Coil door	Assembly, control side, includes latches and hinges		214478		214479			
Panel	Bottom center outer, with suction line connections	AJ1	215276					
		AJ2	256237					
	Cabinet top outer	AJ1	215283	215285	215283	215287	215289	
		AJ2	215863	215865	215863	215867	215869	
Cover	Drain	AJ1, AJ2	223956					
Liner	Bottom center panel	AJ1	222947					
		AJ2	256231					
	Cabinet top	AJ1	215279	215280	215279	215281	215282	
		AJ2	215871	215872	215871	215873	215874	
Door	Filter, assembly, includes latches and hinges	AJ1, AJ2	214474		214476			

*AJ1 = left side controls (when facing system discharge) and AJ2 = right side controls.

**Quantity is one (1) unless otherwise indicated.

NOTE:

- Replacement parts listed in [Table 41](#) for outdoor CW cooling coil cabinets apply to cabinets manufactured *after* SEP 2008 (serial No. date code *BHJ*). For replacement parts for cooling coil cabinets manufactured *before* OCT 2008, contact the factory.
- If a replacement cooling coil is needed, contact your distributor.

Table 41. Outdoor CW Cooling Coil Cabinet (Option AU6) Components

Component	Description	Model RDH	Unit Size					
			75, 100	125, 150	175, 200, 225	250, 300	350, 400A	
			Model REH	10A, 20A, 40A	15B, 30B, 60B	—	30D, 60D, 90D, 120D	40E, 80E, 120E
			Model RXH	000A	000B	000C	000D	000E
			Model RHH	—		130, 180	260	350
Description		Contol Side*	PN (Quantity)**					
Bottom		AJ1	222933	222934	222933	222935	222936	
		AJ2	256184	256185	256184	258186	258187	
Panel	Outer, inlet end, not used with mixing box or evaporator	AJ1	214133	214134	214135	214136	214137	
		AJ2	215421	215422	215423	215424	215425	
	Inner, inlet end	AJ1	214126	214127	214128	214129	214130	
		AJ2	215414	215415	215416	215417	215418	
	Center side, outer, with pipe connection openings	AJ1	215277		215278			
		AJ2	256238		256239			
	Cabinet top, outer	AJ1	215284	215286	215284	215288	215290	
		AJ2	215864	215866	215864	215868	215870	
Wall	Outer, solid, non-control side	AJ1	214349		214350			
		AJ2	215517		215518			
	Inner, solid	AJ1	222937		222938	222971		
		AJ2	256188		256189	256189		
Cover	Control side front corner post	AJ1	223957		223958			
		AJ2	256216		256217			
	Drain	AJ1, AJ2	223956					
Liner	Control side corner post	AJ1	222960		222967			
		AJ2	256190		256191			
	Center side panel	AJ1	223961		223962			
		AJ2	256232		256233			
	Cabinet top	AJ1	215279	215280	215279	215281	215282	
		AJ2	215871	215872	215871	215873	215874	
Connector	Front corner	AJ1, AJ2	211120 (2)		211121 (2)			
Drain pan	Assembly, removable	AJ1	222950	222965	222950	222974	222977	
		AJ2	256222	256223	256222	256224	256225	
Channel	Drain pan, assembly	AJ1	222940	222963	222940	222973	222976	
		AJ2	256218	256219	256218	256220	256221	
Filter track	Bottom	AJ1, AJ2	210084	210085	—			
	Top, assembly		210873	210874				
Angle	Filter rack		210080	210081				
Filter rack	Assembly		—		210870	210871	210872	
Grommet	1-7/8		215292 (2)					
	Drain	208002						
Door	Filter, assembly, includes latches and hinges	AJ1	214475		214477			
		AJ2	215889		215890			

*AJ1 = left side controls (when facing system discharge) and AJ2 = right side controls.

**Quantity is one (1) unless otherwise indicated.

COOLING COIL CABINET COMPONENTS—CONTINUED

NOTE:

- Replacement parts listed in [Table 42](#) for indoor DX cooling coil (with reheat) cabinets apply to cabinets manufactured *after* OCT 2009 (serial No. date code *B/K*). For replacement parts for cooling coil cabinets manufactured *before* NOV 2009, contact the factory.
- If a replacement cooling coil is needed, contact your distributor.

Table 42. Indoor DX Cooling Coil (with Reheat) Cabinet (Option AU7) Components

Component	Models PDH and SDH	Unit Size					
		75, 100	125, 150	175, 200, 225	250, 300	350, 400A	
		Model PEH	10A, 20A, 40A	15B, 30B, 60B	—	30D, 60D, 90D, 120D	40E, 80E, 120E
		Model PXH	000A	000B	000C	000D	000E
Model SHH		—		130, 180	260	350	
Description		Control Side*	PN (Quantity)**				
Bottom	AJ1	222261	222262	222261	—		
	AJ2	223806	223807	223806			
Side	Bottom left	AJ1	—		222194	222193	
	Bottom right	AJ2			222259	222260	
Front corner	Control side, with liquid line connection openings	AJ1	222245		222246		
		AJ2	223808		223809		
Rear corner	Control side	AJ1	210054		210055		
		AJ2	210974		210975		
Liner	Control side front corner	AJ1	222247		222248		
	Control side rear corner	AJ2	223810		223811		
	Top center side panel	AJ1, AJ2	210773		210774		
	Bottom center left side panel	AJ1	222241		222242		
	Non-control side	AJ2	222225		223822		
		AJ1	222223		222224		
Connector	Front corner	AJ2	223824		223825		
		AJ1, AJ2	211120 (2)		211121 (2)		
Post	Center control	AJ1	222218		222219		
		AJ2	223818		223819		
Cover	Center control post, outer	AJ1	222243		222244		
		AJ2	223820		223821		
Panel	Non-control side	AJ1	222206		222207		
	Top, control side, outer, with connection openings	AJ2	223826		223827		
	Bottom, center side, with drain connection opening	AJ1, AJ2	222231		222232		
		AJ1	222230		223823		
Drain pan	Assembly, removable	AJ1, AJ2	258496	259190	258496	258497	
Filter track	Bottom	AJ1, AJ2	210084	210085	—		
	Assembly, top	AJ1, AJ2	210873	210874			
Angle	Filter rack	AJ1, AJ2	210080	210081			
Filter rack	Inner side	AJ1, AJ2	210731		210732		
	Assembly	AJ1, AJ2	—		210870	210871	
Grommet	3/4	AJ1, AJ2	210872				
	1-1/4		220545 (2)				
	2-1/2		220917 (2)				
	1-3/8		220922 (3)				
Plate	Drain	AJ1, AJ2	19816				
Door assembly	Filter/compressor	AJ1, AJ2	222926				
		AJ1, AJ2	222392		222932		
Cabinet top	Assembly	AJ1	222923	222919	222923	222957	
		AJ2	223798	223799	223798	223834	

*AJ1 = left side controls (when facing system discharge) and AJ2 = right side controls.

**Quantity is one (1) unless otherwise indicated.

NOTE:

- Replacement parts listed in [Table 43](#) for outdoor DX cooling coil (with reheat) cabinets apply to cabinets manufactured *after* OCT 2009 (serial No. date code *BIK*). For replacement parts for cooling coil cabinets manufactured *before* NOV 2009, contact the factory.
- If a replacement cooling coil is needed, contact your distributor.

Table 43. Outdoor DX Cooling Coil (with Reheat) Cabinet (Option AU7) Components

Component	Model RDH	Unit Size					
		75, 100	125, 150	175, 200, 225	250, 300	350, 400A	
		Model REH	10A, 20A, 40A	15B, 30B, 60B	—	30D, 60D, 90D, 120D	40E, 80E, 120E
		Model RXH	000A	000B	000C	000D	000E
Model RHH		—		130, 180	260	350	
Description		Control Side*	PN (Quantity)**				
Bottom	AJ1	222303	222304	222303	222317 222316	222319 222318	
	AJ2	223861	223862	223861	223904 223903	223906 223953	
Panel	Outer, inlet end, not used with mixing box or evaporator	AJ1	214133	214134	214135	214136	214137
		AJ2	223879	223880	223881	223882	223883
	Inner, inlet end	AJ1	214126	214127	214128	214129	214130
		AJ2	223874	223875	223876	223877	223878
	Center bottom side, outer, with pipe connection openings	AJ1	222361				
		AJ2	223898				
Cabinet top, outer	AJ1	222366	222367	222366	223279	223288	
	AJ2	223901	223902	223901	223917	223921	
Post	Control side front corner, with piping connection openings	AJ1	222960		214471		
		AJ2	223884		223885		
	Center	AJ1	222358		222359		
		AJ2	223869		223870		
Cover	Control side front corner	AJ1	222961		214445		
		AJ2	223886		223887		
	Center post	AJ1	222356		222357		
		AJ2	223871		223872		
	Suction line connection		222386				
	Drain		222387				
Connector	Front corner		211120 (2)		211121 (2)		
Drain pan	Assembly		255007	255008	255008	255009 255010	
Filter track	Bottom		210084	210085	—		
	Assembly, top		210873	210874	—		
Angle	Filter rack		210080	210081	—		
Filter rack	Assembly		—		210870	210871 210872	
Liner	Center, bottom side panel	AJ1	222355				
		AJ2	223873				
	Cabinet top	AJ1	222297	222309	222297	223278 223287	
		AJ2	223899	223900	223899	223910 223913	
Grommet	1-1/4		220917 (2)				
	3/4		220545 (2)				
	1-3/8		220917 (2)				
	2-1/2		220922				
Door assembly	Filter/compressor, includes latches and hinges		223266		223272		
	Coil, includes latches and hinges		223267		223273		
Wall	Outer, solid, non-control side	AJ1	222307		222308		
		AJ2	223896		223897		
	Inner, solid, liner	AJ1	222305		222306		
		AJ2	223892		223893		

*AJ1 = left side controls (when facing system discharge) and AJ2 = right side controls.

**Quantity is one (1) unless otherwise indicated.

COOLING COIL CABINET COMPONENTS—CONTINUED

NOTE:

- MASA model condensing units use R410A refrigerant. When a DX cooling coil cabinet is installed with a MASA model condensing unit, a frostat and a Thermostatic Expansion Valve (TXV) is required. The replacement part must be identical to the original.
- The frostat (model 3NT015, opens @35°F/closes @50°F, PN 177233) is shown in [Figure 26](#).
- TXVs are shown in [Figure 26](#) and listed in [Table 44](#).

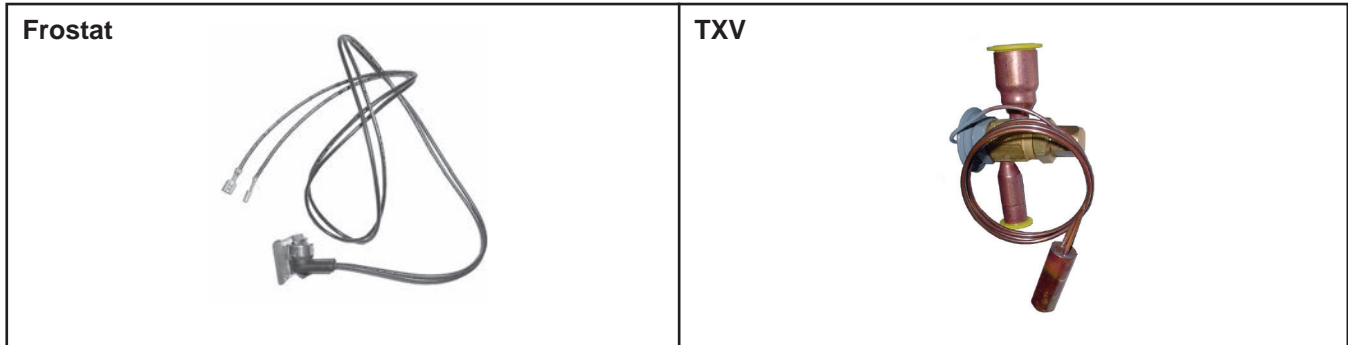


Figure 26. Frostat and TXV Used on DX Cooling Coil Cabinet with MASA Model Condensing Unit

Table 44. TXV Used on DX Cooling Coil Cabinet with MASA Model Condensing Unit

TXV Option	Sporlan No.	Distributor Size	Low MBH	High MBH	TXV Inlet	TXV Outlet	PN
T41A, T41B	BBIZE-1.5	0.6	18	28	0.6275 ID	0.6275 ID	220551
T42A, T42B	BBIZE-2	0.6	24	39	0.6275 ID	0.6275 ID	220552
T43A, T43B	BBIZE-3	0.6	36	52	0.6275 ID	0.6275 ID	220553
T44A, T44B, T44C	BBIZE-4	0.6	48	74	0.6275 ID	0.8775 ID	220554
T46B, T46C	BBIZE-6	0.9	72	99	0.6275 ID	0.8775 ID	220555
T48B, T48C	BBIZE-8	0.9	96	151	0.6275 ID	0.8775 ID	220556
T4EB, T4EC, T4ED	BBIZE-15	0.9	151	241	0.8775 ID	1.128 ID	220558

NOTE: Option UV2 is an ultraviolet, germicidal light for the cooling coil in the blower section. The components for option UV2 are shown in [Figure 27](#) and listed in [Table 45](#).

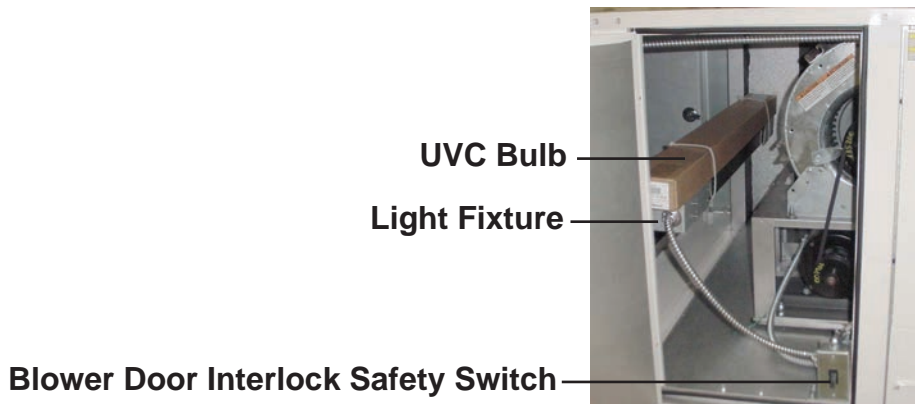


Figure 27. Option UV2 Components

Table 45. Option UV2 Components

Component	Models PDH, RDH, and SDH	Unit Size			
		75, 100	125, 150	175, 200, 225	250, 300, 350, 400A
	Models PEH and REH	10A, 20A, 40A	15B, 30B, 60B	—	30D, 60D, 90D, 120D, 40E, 80E, 120E
	Models PXH and RXH	000A	000B	000C	000D, 000E
	Models RHH and SHH	—		130, 180	260, 350
Description		PN (Quantity)*			
UVC bulb (Steril-Aire #GTD VO)	22-inch (559 mm)	220440	—	220440	—
	34-inch (864 mm)	—	220441	—	—
	40-inch (1016 mm)	—	—	—	220442 (2)
Light fixture, 115/208/230V	Steril-Aire #DE-241VO	220434	—	220434 (2)	—
	Steril-Aire #DE-361VO	—	220435	—	—
	Steril-Aire #DE-421VO	—	—	—	220436 (2)
Safety switch	Blower door interlock	217262			

*Quantity is one (1) unless otherwise indicated.


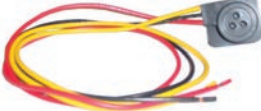
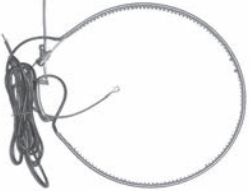







Item 1: Compressor 	Item 1A: Molded Plug 	Item 4: Crankcase Heater 
	Item 5: High Pressure Switch 	Item 6: Low Pressure Switch 
Item 9: Thermostatic Expansion Valve for Reheat Circuit 	Item 10: Filter Drier 	Item 14: Electric Bypass Valve 
Item 11: Froststat 	Item 12: DH Relay 	

Figure 28. DX Cooling Coil Cabinet (with Reheat) Electrical Components (Refer to Table 46)

COOLING COIL CABINET COMPONENTS—CONTINUED

Table 46. DX Cooling Coil Cabinet (with Reheat) Electrical Components							
Item No.	Models PDH, RDH, and SDH		Unit Size				
			75, 100	125, 150	175, 200, 225	250, 300	350, 400A
	Models PEH and REH		10A, 20A, 40A	15B, 30B, 60B	—	30D, 60D, 90D, 120D	40E, 80E, 120E
	Models PXH and RXH		000A	000B	000C	000D	000E
	Models RHH and SHH		—		130, 180	260	350
Component		Description	PN				
1	Reheat compressor	208/1/60 (option AK2)	216673			216685	
		230/1/60 (option AK3)					
		208/3/60 (option AK5)	216674			216686	
		230/3/60 (option AK6)					
		460/3/60 (option AK7)	216675			216687	
		575/3/60 (option AK8)	234055			216688	
1A	Molded plug for compressor	208/1/60 (option AK2)	234063				
		230/1/60 (option AK3)					
		208/3/60 (option AK5)	208374				
		230/3/60 (option AK6)					
		460/3/60 (option AK7)					
		575/3/60 (option AK8)					
2	Capacitor	Start, 208&230/1/60 (options AK2 and AK3)	234065			234066	
3	(not shown)	Run, 208&230/1/60 (options AK2 and AK3)	234067			234068	
4	Crankcase heater	208&230/1&3/60 (options AK2, AK3, AK5, and AK6)	216434			216398	
		460/3/60 (option AK7)	216436			216400	
		575/3/60 (option AK8)	216437			216401	
5	Pressure switch	High, manual reset	216379				
6		Low, auto reset	216380				
7	Reheat coil	Evaporator	216440	216441	216442	216443	216444
8	(not shown)	Condenser	216445	216446	216447	216448	216449
9	Thermostatic expansion valve for reheat circuit	BBIZE-2, 208&230/1&3/60 (options AK2, AK3, AK5, and AK6)	220552			—	
		BBIZE-4, 208&230/1&3/60 (options AK2, AK3, AK5, and AK6)	—			220554	
		BBIZE-2, 460/3/60 (option AK7)	220552			—	
		BBIZE-4, 460/3/60 (option AK7)	—			220554	
		BBIZE-5, 460/3/60 (option AK7)	—			234052	—
		BBIZE-2, 575/3/60 (option AK8)	220552			—	
10	Filter drier	Sporlan C-164-S	177379			—	
		Sporlan C-304-S	—			216408	
11	Frostat	Model 3NT015, opens @35°F, closes @50°F	177233				
12	Relay	DH	234656				
13	Controller (not shown)	FX06, with software	Refer to item 39 in Table 3				
14	Bypass valve	Electric, modulating reheat (option AUR1)	234062				

OPTION AR8: ON/OFF DAMPER WITHOUT MIXING BOX



Figure 29. Option AR8: Damper Assembly (Indoor Model Shown)

Table 47. Option AR8 Damper Assembly Components						
Component	Models PDH and SDH	Unit Size				
		75, 100	125, 150	175, 200, 225	250, 300	350, 400A
	Model PEH	10A, 20A, 40A	15B, 30B, 60B	—	30D, 60D, 90D, 120D	40E, 80E, 120E
	Model PXH	000A	000B	000C	000D	000E
	Model SHH	—		130, 180	260	350
Description		PN				
Indoor Damper Assembly (Includes Duct Flange)						
Damper assembly		221887	221888	221889	221890	221891
Damper (AJ1 and AJ2)	21-1/8 x 18-1/2 inches	15869	—			
	26-5/8 x 18-1/2 inches	—	12634	—		
	23 x 23-5/8 inches	—		194839	—	
	36 x 20 inches	—			205068	—
	40-3/8 x 23 inches	—			179168	
Damper motor	24V, ON/OFF (J/C #M9206-BGB-2001)	209351				
Component	Model RDH	Unit Size				
		75, 100	125, 150	175, 200, 225	250, 300	350, 400A
	Model REH	10A, 20A, 40A	15B, 30B, 60B	—	30D, 60D, 90D, 120D	40E, 80E, 120E
	Model RXH	000A	000B	000C	000D	000E
	Model RHH	—		130, 180	260	350
Description		PN				
Outdoor Damper Assembly (Requires Option AS2 Hood)						
Damper assembly	AJ1	259659	259660	259661	259662	259663
	AJ2	259664	259665	259666	259667	259668
Damper (AJ1 and AJ2)	23 x 18.5	211420	—			
	33 x 18.5	—	259669	—		
	23 x 24.5	—		259670	—	
	39.25 x 24.5	—			259671	—
	47.25 x 24.5	—			259672	
Damper motor	24V, ON/OFF (J/C #M9206-BGB-2001)	209351				

INLET DUCT FLANGE, INLET SCREEN, AND REPLACEMENT FILTERS

NOTE: The components listed in Table 48 apply to left- (AJ1) and right-side (AJ2) controls.

Table 48. Inlet Duct Flange, Inlet Screen, and Replacement Filters							
Component	Models PDH, RDH, and SDH	Unit Size					
		75, 100	125, 150	175, 200, 225	250, 300	350, 400A	
		Models PEH and REH	10A, 20A, 40A	15B, 30B, 60B	—	30D, 60D, 90D, 120D	40E, 80E, 120E
		Models PXH and RXH	000A	000B	000C	000D	000E
	Models RHH and SHH	—		130, 180	260	350	
Description		PN (Quantity)*					
Inlet duct flange	In option AR5, for blower cabinet	211826 (2)		211827 (2)			
		211828 (2)	211829 (2)	211828 (2)	211830 (2)	211831 (2)	
End panel with inlet duct flange (in option ARA6) for cooling coil cabinet (option AU5, AU6, or AU7)	End panel	211348	211349	211350	211351	211352	
	Side support	211122 (2)					
	Top support	211123 (2)	211124 (2)	211123 (2)	211125 (2)	2111212 (2)	
	Duct flange side	211218 (2)					
	Duct flange top/bottom	211213 (2)	211214 (2)	211213 (2)	211215 (2)	211216 (2)	
Inlet screen	In option AZ1, for blower cabinet	214996	214997	214998	214999	215000	
	In option GZ1, GZ2, GZ3, or GZ4, for mixing box	215001	215002	215001	215003	215004	
Replacement Filters for Filter Rack in Blower Cabinet or Cooling Coil Cabinet							
Disposable filter (same as option AW2)	1 x 16 x 16 inches	—		66596 (2)	66596 (3)	66596	
	1 x 16 x 20 inches	—		16445 (2)	16445 (3)	16445 (3)	
	1 x 16 x 25 inches	16447 (2)	—				
	1 x 20 x 20 inches	—			16448 (2)		
	1 x 20 x 25 inches	—	16446 (2)	—			
Disposable filter (same as option AW7)	2 x 16 x 16 inches	—		104101 (2)	104101 (3)	104101	
	2 x 16 x 20 inches	—		104097 (2)	104097 (3)	104097 (3)	
	2 x 16 x 25 inches	104099 (2)	—				
	2 x 20 x 20 inches	—			104098 (2)		
	2 x 20 x 25 inches	—	104100 (2)	—			
Permanent filter (same as option AW8)	1 x 16 x 16 inches	—		104102 (2)	104102 (3)	104102	
	1 x 16 x 20 inches	—		101607 (2)	101607 (3)	101607 (3)	
	1 x 16 x 25 inches	101609 (2)	—				
	1 x 20 x 20 inches	—			101608 (2)		
	1 x 20 x 25 inches	—	101610 (2)	—			
Permanent filter (same as option AW9)	2 x 16 x 16 inches	—		104103 (2)	104103 (3)	104103	
	2 x 16 x 20 inches	—		101620 (2)	101620 (3)	101620 (3)	
	2 x 16 x 25 inches	101622 (2)	—				
	2 x 20 x 20 inches	—			101621 (2)		
	2 x 20 x 25 inches	—	101623 (2)	—			
Pleated disposable filter (same as option AW10)	1 x 16 x 16 inches	—		104104 (2)	104104 (3)	104104	
	1 x 16 x 20 inches	—		104105 (2)	104105 (3)	104105 (3)	
	1 x 16 x 25 inches	104107 (2)	—				
	1 x 20 x 20 inches	—			104106 (2)		
	1 x 20 x 25 inches	—	104108 (2)	—			
Pleated disposable filter (same as option AW11)	2 x 16 x 16 inches	—		104109 (2)	104109 (3)	104109	
	2 x 16 x 20 inches	—		104110 (2)	104110 (3)	104110 (3)	
	2 x 16 x 25 inches	104112 (2)	—				
	2 x 20 x 20 inches	—			104111 (2)		
	2 x 20 x 25 inches	—	104113 (2)	—			
Pleated disposable filter (same as option AW21)	4 x 16 x 16 inches	—		211126 (2)	211126 (3)	211126	
	4 x 16 x 20 inches	—		211127 (2)	211127 (3)	211127 (3)	
	4 x 16 x 25 inches	211128 (2)	—				
	4 x 20 x 20 inches	—			205790 (2)		
	4 x 20 x 25 inches	—	205791 (2)	—			
Pleated disposable filter (same as option AW24)	4 x 16 x 16 inches	—		256664 (2)	256664 (3)	256664	
	4 x 16 x 20 inches	—		256665 (2)	256665 (3)	256665 (3)	
	4 x 16 x 25 inches	256666 (2)	—				
	4 x 20 x 20 inches	—			256662 (2)		
	4 x 20 x 25 inches	—	256663 (2)	—			

*Quantity is one (1) unless otherwise indicated.

Component	Models PDH, RDH, and SDH	Unit Size				
		75, 100	125, 150	175, 200, 225	250, 300	350, 400A
	Models PEH and REH	10A, 20A, 40A	15B, 30B, 60B	—	30D, 60D, 90D, 120D	40E, 80E, 120E
	Models PXH and RXH	000A	000B	000C	000D	000E
	Models RHH and SHH	—		130, 180	260	350
	Description	PN (Quantity)*				
Pleated disposable filter (same as option AW38)	4 x 16 x 16 inches	—		1036158 (2)	1036158 (3)	1036158
	4 x 16 x 20 inches	—		1036159 (2)	1036159 (3)	1036159 (3)
	4 x 16 x 25 inches	1036160 (2)	—			
	4 x 20 x 20 inches	—		—		
	4 x 20 x 25 inches	—	1036163 (2)	—		

*Quantity is one (1) unless otherwise indicated.

OPTION AS2: INLET AIR HOOD COMPONENTS (MODELS RDH, RHH, RXH, AND REH)

NOTE: In [Figure 30](#), the screen (item 5) covers the inlet air hood opening and is secured using screen retainers (item 6) and clamps (item 7).

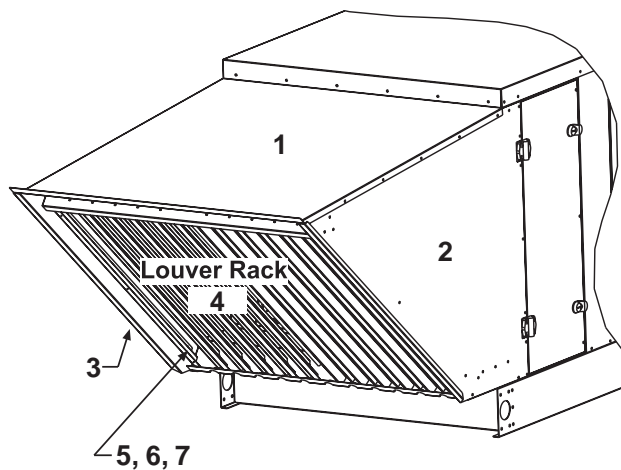


Figure 30. Inlet Air Hood Assembly (Refer to [Table 49](#))

Item No.	Model RDH	Model REH	Unit Size				
			75, 100	125, 150	175, 200, 225	250, 300	350, 400A
	Model RXH	000A	000B	000C	000D	000E	
	Model RHH	—		130, 180	260	350	
Component	Description	PN (Quantity)*					
—	Option package	Inlet air hood assembly	215223	215224	215225	215226	215227
1		Top	215260	215261	215262	215263	215264
2	Panel	Left side	215256		215257		
3		Right side	215258		215259		
4	Rack	Louver	215614	215615	215614	215616	215617
5	Screen		215610	215611	215610	215612	215613
6	Retainer	Screen	214851 (2)				
7	Clamp	Screen	214852 (2)				
8	Sheet metal screw	#10-16 x 1/2, standard point, slotted head	11813 (45)				
9	Self-drilling screw	#10-16 x 1/2, drill point, hex head	37661 (20)				
10	Silicone	3-ounce tube	53335				

*Quantity is one (1) unless otherwise indicated.

MIXING BOX COMPONENTS

NOTE: Mixing box dampers and damper control components are shown in [Figure 31](#) and listed in [Table 50](#).

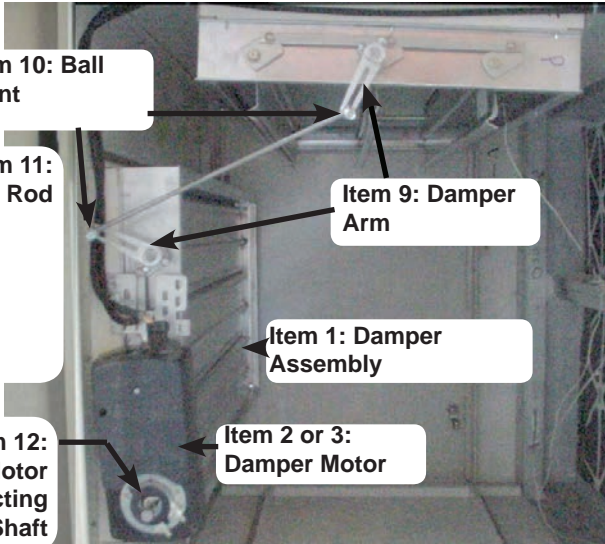

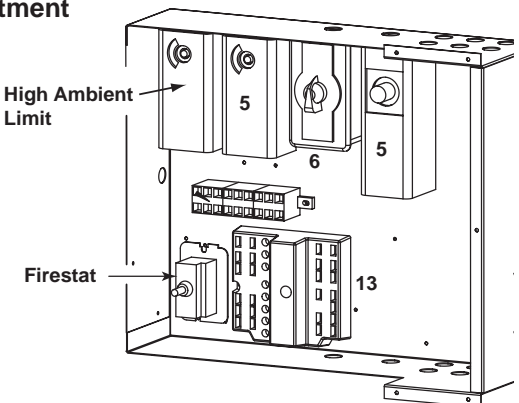








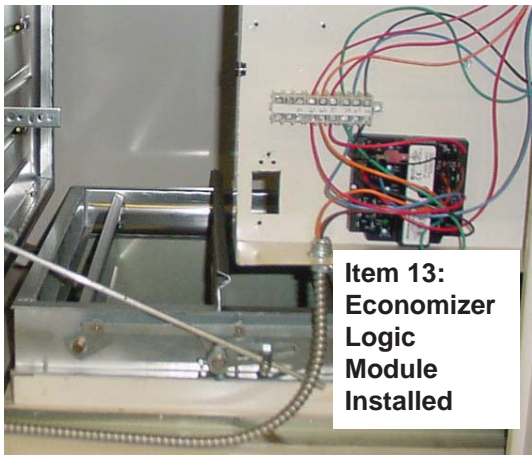
<p>Inside View of Indoor Mixing Box with Top and Rear Inlet Openings with Dampers</p> 	<p>Item 2 or 3: Damper Motor</p> 	<p>Item 5: Return Air Controller</p> 
<p>Location of Controls in the Mixing Box Electrical Compartment</p> 	<p>Item 6: Potentiometer</p> 	<p>Item 7: Mixed Air Controller</p> 
<p>Item 13: Economizer Logic Module</p> 	<p>Item 8: Pressure Null Switch</p> 	<p>Item 9: Damper Arm</p> 
<p>Item 14: Enthalpy Sensor</p> 	<p>Item 10: Ball Joint</p> 	<p>Item 15: Mixed Air Sensor</p> 
<p>Mixing Box with Economizer Logic Module Used in Options GE21 and GE22 (Sensors (Item 15) Are Field-Installed)</p> 	<p>Item 13: Economizer Logic Module Installed</p>	

Figure 31. Mixing Box Dampers and Damper Controls (Refer to [Table 50](#))

Table 50. Mixing Box Dampers and Damper Controls

Item No.	Component	Models PDH, RDH, and SDH	Unit Size					
			75, 100	125, 150	175, 200, 225	250, 300	350, 400A	
		Models PEH and REH	10A, 20A, 40A	15B, 30B, 60B	—	30D, 60D, 90D, 120D	40E, 80E, 120E	
		Models PXH and RXH	000A	000B	000C	000D	000E	
		Model SHH	—		130, 180	260	350	
	Description	PN						
1	Damper assembly*	23 x 18.3 inches	211420		—			
		26.625 x 18.5 inches	—	12634	—			
		23 x 18.3 inches	—		211420	—		
		34.875 x 18.5 inches	—		15870		—	
		45.875 x 18.5 inches	—		12640			
All Models and Unit Sizes Unless Otherwise Indicated								
Item No.	Component	Description	Damper Control (GE) Option				PN	
2	Damper motor	Two-position (J/C M9206-BGB-201)	GE3, GE6, GE7				209351	
2A	Mounting bracket	Damper motor	GE3, GE4, GE6, GE7				211418	
3	Damper motor	Three-position or modulating (AF24-MFT95-US)	GE4, GE8, GE10, GE11, GE12, GE13, GE14				159877	
		Modulating (J/C M9106AGC-2)	GE15				211416	
		Modulating (J/C M9208GGC-3)	GE16, GE21, GE22				211417	
4	Quadrant	Manual (#9250) (not shown)	GE5				103502	
5	Controller	Return air (J/C #A19AAF-120)	GE7, GE13, GE14				126170	
6	Potentiometer	Used only on cabinets A, C, D, and E (M/H 112894FA)	GE4, GE8, GE11, GE12, GE14				16110	
7	Controller	Mixed air (M/H T991A-1004)	GE11, GE12, GE13, GE14				16109	
8	Switch	Pressure null, Dwyer 1640-0	GE15				88052	
9	Arm	Damper	GE6, GE7, GE8, GE10, GE11, GE12, GE13, GE14, GE15, GE16, GE21, GE22				66278	
10	Joint	Ball (quantity 2)					12636	
11	Damper rod**	14-inch (355-mm) (quantity 2)	GE6				95497	
		24-inch (355-mm) (quantity 2)	GE7, GE8, GE10, GE11, GE12, GE13, GE14, GE15, GE16, GE21, GE22				171774	
12	Shaft	Damper motor connecting	GE3, GE4, GE6, GE7, GE8, GE10, GE11, GE12, GE13, GE14, GE15, GE16, GE21, GE22				214299	
13	Logic module	Economizer (H/W #W7212A1009)	GE21, GE22				220637	
14	Sensor	Enthalpy, in outside air inlet/duct or in return air duct (H/W #C7400A1004)					196290	
15		Mixed air, in blower cabinet (H/W #C7150B1004)					196291	
16	Holder	For mixed air sensor (not shown)	171772					

*Purchased damper assembly used in both return air and/or outside air opening.

**Long rod that connects the two damper arms at the two ball joints.

NOTE: Components for the 30% outside air hood in option GD6 are shown in Figure 32 and listed in Table 51. Refer to Table 49 for option AS2, the field-installed hood designed for GE options with a large opening for outside air.

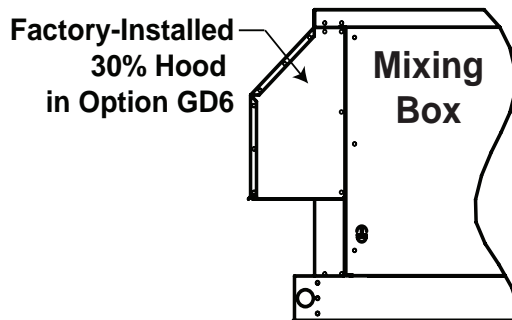


Figure 32. Mixing Box Outside Air Hood in Option GD6 (Refer to Table 51)

MIXING BOX COMPONENTS—CONTINUED

Table 51. Mixing Box Outside Air Hood in Option GD6						
Component	Model RDH	Unit Size				
		75, 100	125, 150	175, 200, 225	250, 300	350, 400A
		10A, 20A, 40A	15B, 30B, 60B	—	30D, 60D, 90D, 120D	40E, 80E, 120E
	Model RXH	000A	000B	000C	000D	000E
Description		PN				
Hood assembly, outside air, 30% opening (options GE1 & GE2)	23 x 8.3 inches	211419		—		
	26.625 x 8.125 inches	—	37712	—		
	23 x 8.3 inches	—		211419	—	
	34.875 x 8.125 inches	—		37713		—
	45.875 x 8.125 inches	—			37715	
Panel	Top	215172	215173	215174	215175	215176
	Right	215177		215178		
	Left	215179		215180		
Screen		215181	215182	215181	215183	215184

NOTE: Mixing box cabinet components are shown in [Figure 33](#) and listed in [Table 52](#).

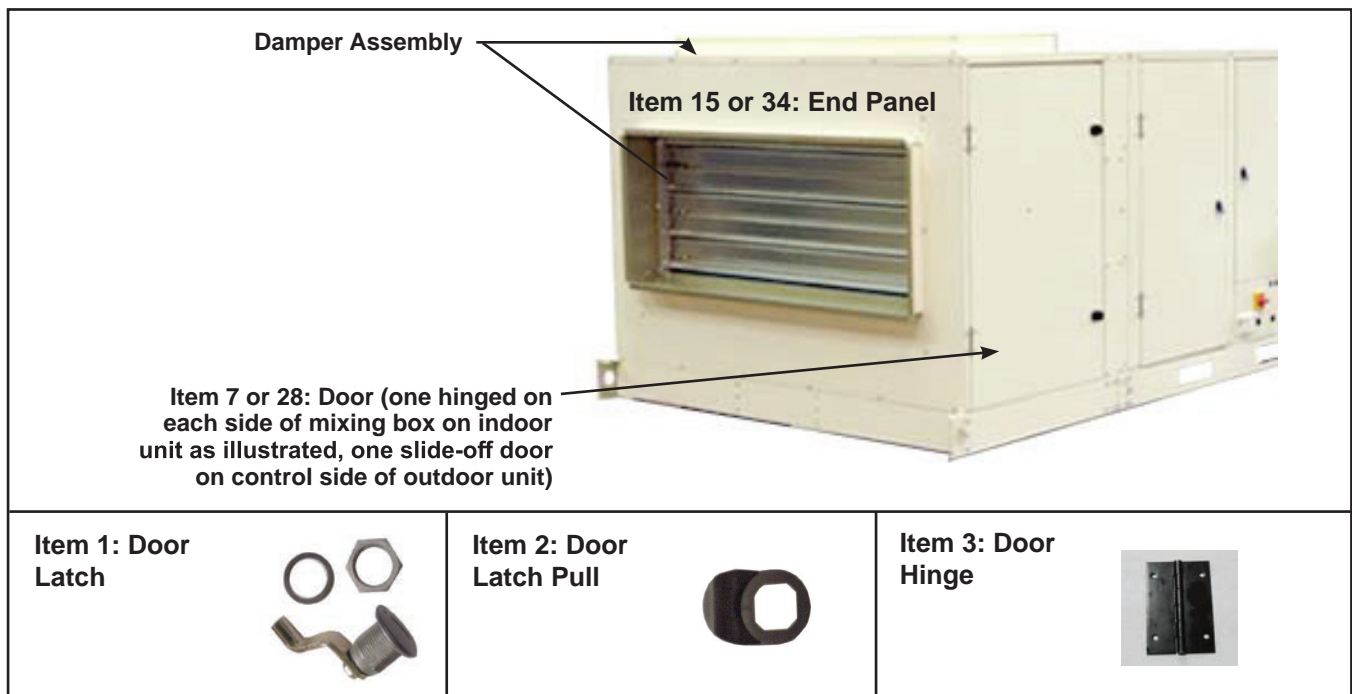


Figure 33. Mixing Box Cabinet Components (Refer to [Table 52](#))

Table 52. Mixing Box Cabinet Components

Item No.	Component	Models PDH, RDH, and SDH	Unit Size						
			75, 100	125, 150	175, 200, 225	250, 300	350, 400A		
			Models PEH and REH		10A, 20A, 40A	15B, 30B, 60B	—	30D, 60D, 90D, 120D	40E, 80E, 120E
			Models PXH and RXH		000A	000B	000C	000D	000E
			Model SHH		—		130, 180	260	350
Description		Control Side*	PN (Quantity)**						
1	Latch	Door (2 per door)	204469 (2)						
2	Latch pull	Door (2 per door)	204470 (2)						
3	Hinge	Door, indoor models only (2 per door)	210029 (2)						
Indoor Mixing Box Cabinet Components (Uninsulated Unless Otherwise Indicated)									
4	Corner	Left (not shown)	211118		211119				
5		Right (not shown)	211116		211117				
6	Door	With no insulation or hardware (not shown)	211106 (2)		211107 (2)				
7	Door assembly	With insulation (AY2), latches, and hinges	214984 (2)		214985 (2)				
		Double-walled, with insulation (AY3) and latches	214986 (2)		214987 (2)				
		Double-walled, with high-density insulation (AY3H) and latches	214988 (2)		214989 (2)				
8	Top (not shown)	211088	211089	211088	211090	211091			
9	Liner	Top (not shown)	212223	212224	212225	212226	212227		
10	Plug	Damper, fills unused opening (not shown)	211219	211220	211219	211221	211222		
11	Plug-in liner	Damper (not shown)	212232	212233	212232	212234	212235		
12	Bottom (not shown)		211102	211103	211102	211104	211105		
13	Liner	Bottom (not shown)	212228	212229	212228	212230	212231		
14	Liner	Front post (not shown)	213384		213385				
15	Panel	End	211092	211093	211094	211095	211096		
16	Liner	End panel (not shown)	212218	212219	212220	212221	212222		
17	Damper support	Top/bottom (not shown)	211213 (2)	211214 (2)	211213 (2)	211215 (2)	211216 (2)		
18		Side (not shown)	211218 (2)						
19		End (not shown)	211123 (2)	211124 (2)	211123 (2)	211125 (2)	2111212 (2)		
Outdoor Mixing Box Cabinet Components									
20	Liner	Top (not shown)	AJ1	214353	214354	214353	214355	214356	
			AJ2	215521	215522	215521	215523	215524	
21	Panel	Top, outer (not shown)	AJ1	214357	214358	214357	214359	214360	
			AJ2	215525	215526	215525	215527	215528	
22	Liner	Bottom (not shown)	AJ1, AJ2	214366	214367	214366	214368	214369	
23	Bottom (not shown)		AJ1	214311	214312	214311	214313	214314	
			AJ2	215479	215480	215479	215481	215482	
24	Post (not shown)		AJ1	214315		214316			
			AJ2	215483		215484			
25	Panel	Post, outer (not shown)	AJ1	214351		214352			
			AJ2	215519		215520			
26	Panel	Solid wall, inner (not shown)	AJ1	214347		214348			
			AJ2	215515		215516			
27	Panel	Solid wall, outer (not shown)	AJ1	214349		214350			
			AJ2	215517		215518			
28	Door assembly	Double-walled, with insulation (AY3) and latches	215062		215063				
		Double-walled, with high-density insulation (AY3H) and latches	215064		215065				
29	Damper support	End (not shown)	214362 (2)	214363 (2)	214362 (2)	214364 (2)	214365 (2)		
30		Side (not shown)	214361 (2)						
31		Top/bottom (not shown)	211213 (2)	211214 (2)	211213 (2)	211215 (2)	211216 (2)		
32	Plug	Damper, fills unused opening (not shown)	212232	212233	212232	212234	212235		
33	Plug-in liner	Damper (not shown)	211219	211220	211219	211221	211222		
34	Panel	End	AJ1	214317	214318	214319	214320	214321	
			AJ2	215485	215486	215487	215488	215489	
35	Panel	Outside, end (not shown)	AJ1	214332	214333	214334	214335	214336	
			AJ2	215500	215501	215502	215503	215504	

*AJ1 = left side controls (when facing system discharge) and AJ2 = right side controls.

**Quantity is one (1) unless otherwise indicated.

LOUVER ASSEMBLY COMPONENTS

NOTE:

- If a discharge sensor (see [Figure 34](#)) is installed with the louvers, attach the sensor holder (item 61, [Table 3](#)) using a bracket (item 62, [Table 3](#)).
- Louver assembly components are listed in [Table 53](#).

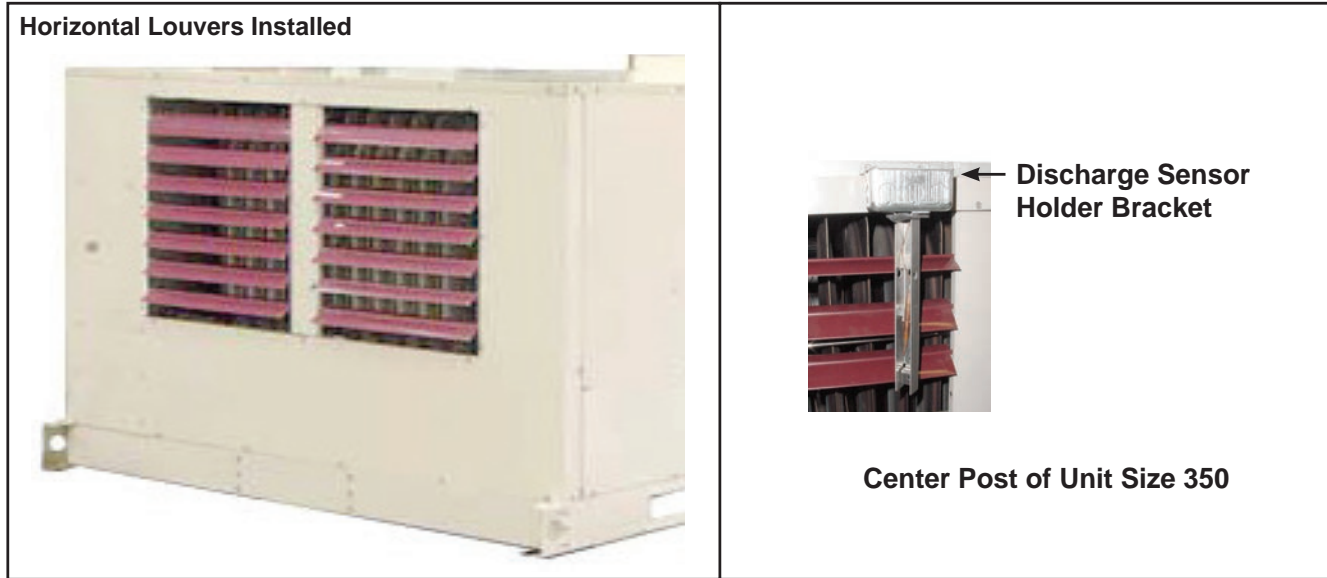


Figure 34. Louvers

Table 53. Louver Options

Option	Component	Models PDH and SDH	Unit Size				
			75, 100	125, 150	175, 200, 225	250, 300	350, 400A
		Model PXH*	000A	000B	000C	000D	000E
		Model SHH	—		130, 180	260	350
Description		PN (Quantity)**					
AX2	Louver assembly	Horizontal	213280	213281	213282	213283	213284
	Spring	Compression	195046 (4)	195046 (8)	195046 (7)	195046 (14)	
	Horizontal louver	18-1/8-inch (460-mm)	201830 (4)	—		201830 (14)	
		13-1/4-inch (337-mm)	—	196231 (8)	—	196231 (14)	—
		21-1/4-inch (540-mm)	—		196233 (7)	—	
	Louver support	Center	—	210625	—	210626	210627
Sheet metal screw	For center support	—		165638 (4)	165638 (4)		
AX3	Louver assembly	Horizontal and vertical	213285	213286	213287	213288	213289
	Spring	Compression	195046 (10)	195046 (17)	195046 (14)	195046 (23)	195046 (26)
	Horizontal louver	18-1/8-inch (460-mm)	201830 (4)	—		201830 (14)	
		13-1/4-inch (337-mm)	—	196231 (8)	—	196231 (14)	—
		21-1/4-inch (540-mm)	—		196233 (7)	—	
	Louver support	Horizontal, center	—	210625	—	210626	210627
	Frame side	Vertical louver	210742 (2)		210743 (2)		
	Frame support	Vertical louver	210744 (2)	210745 (2)	210746 (2)	210747 (2)	210748 (2)
	Sheet metal screw	#8-18 x 3/8	195638 (14)	195638 (18)		195638 (22)	
	Vertical louver	14-3/16-inch (360-mm)	195314 (6)	195314 (9)	—		
23-3/8-inch (594-mm)		—		195578 (7)	195578 (9)	195578 (12)	

*Model PXH **without** hot water coil.
 **Quantity is one (1) unless otherwise indicated.
 ***Model PXH **with** hot water coil.

Table 53. Louver Options—Continued

Option	Component	Model PXH***	Unit Size				
			000A	000B	000C	000D	000E
		Description	PN (Quantity)**				
<i>For horizontal louvers, order following parts:</i>							
AX2	Stop	Louver, offset	260658		260659		
	Support	Louver, side	260656 (2)		260657 (2)		
		Top and bottom	260652 (2)	260653 (2)	260652 (2)	260654 (2)	260655 (2)
	Spring	Compression	195046 (9)	195046 (18)	195046 (12)	195046 (24)	
	Horizontal louver	18-1/8-inch (460-mm)	201830 (4)	—		201830 (14)	
		13-1/4-inch (337-mm)	—	196231 (8)	—	196231 (14)	—
		21-1/4-inch (540-mm)	—		196233 (7)	—	
	Louver support	Center	—	262016	—	262015	260675
Sheet metal screw		11813 (21)	11813 (27)	11813 (21)	11813 (27)		
			37661 (3)				
<i>For horizontal and vertical louvers, order parts above for horizontal louvers plus following:</i>							
AX3	Support	Top and bottom	260646 (2)	260647 (2)	260646 (2)	260648 (2)	260649 (2)
		Side	260650 (2)		260651 (2)		
	Louver support	Center	—		260211	260213	260212
	Vertical louver	16-19/64-inch (414-mm)	—		201249 (16)	201249 (28)	201249 (32)
		26-inch (660-mm)	201251 (8)	201251 (12)	—		
	Spring	Compression	195046 (8)	195046 (12)	195046 (16)	195046 (28)	195046 (32)
	Sheet metal screw		11813 (26)		11813 (30)		
*Model PXH <i>without</i> hot water coil.							
**Quantity is one (1) unless otherwise indicated.							
***Model PXH <i>with</i> hot water coil.							

DISCHARGE OPTION COMPONENTS

NOTE:

Discharge options are as follows:

- Option AX4: horizontal discharge duct flange (refer to [Figure 35](#) and [Table 54](#)) is optional on models PDH, PXH, RXH. RHH, SDH, SHH, and RDH and is standard on models PEH and REH
- Double-walled downturn plenum for bottom discharge (refer to [Figure 36](#) and [Table 55](#)) is factory-installed on models RDH, RXH, REH, and RHH:
 - 1) With no damper (option AQ5)
 - 2) With motorized open/closed damper (option AQ8)
- Downturn discharge nozzle (refer to [Figure 37](#) and [Table 56](#)) is optional on PDH, SDH, SHH, and PXH models without a hot water coil:
 - 1) 25- to 65-degree discharge nozzle kit (same as option CD2)
 - 2) 50- to 90-degree discharge nozzle kit (same as option CD3)
 - 3) 25- to 65-degree discharge nozzle kit (option CD4)
 - 4) 50- to 90-degree discharge nozzle kit (option CD5)

DISCHARGE OPTION COMPONENTS—CONTINUED



Figure 35. Option AX4: Horizontal Discharge Duct Flange

Table 54. Horizontal Discharge Duct Flange (Option AX4)						
Component	Models PDH, RDH, and SDH	Unit Size				
		75, 100	125, 150	175, 200, 225	250, 300	350, 400A
	Models PEH and REH	10A, 20A, 40A	15B, 30B, 60B	—	30D, 60D, 90D, 120D	40E, 80E, 120E
	Models PXH and RXH*	000A	000B	000C	000D	000E
	Models RHH and SHH	—		130, 180	260	350
Description		PN (Quantity)**				
Option package	Horizontal duct flange	213290	213291	213292	213293	213294
Connector	Duct	210701 (2)	210702 (2)	210703 (2)	210704 (2)	210705 (2)
Sheet metal screw	10-16 x 1/2	11813 (20)	11813 (24)	11813 (22)	11813 (26)	11813 (30)
Component	Model PXH***	Unit Size				
		000A	000B	000C	000D	000E
Description		PN (Quantity)**				
Order following parts:						
Duct flange	Bottom	262208	262209	262208	262210	262211
	Side	262212 (2)		262213 (2)		
	Top	262214	262215	262214	262216	262217
Sheet metal screw		11813 (16)				
Component	Model RXH***	Unit Size				
		000A	000B	000C	000D	000E
Description		PN (Quantity)**				
Order following parts:						
Duct flange	Top/bottom	261055	261056	261055	261058	261059
	Side	261060 (2)		261061 (2)		
Sheet metal screw		11813 (20)				
*Model PXH or RXH without hot water coil.						
**Quantity is one (1) unless otherwise indicated.						
***Model PXH or RXH with hot water coil.						

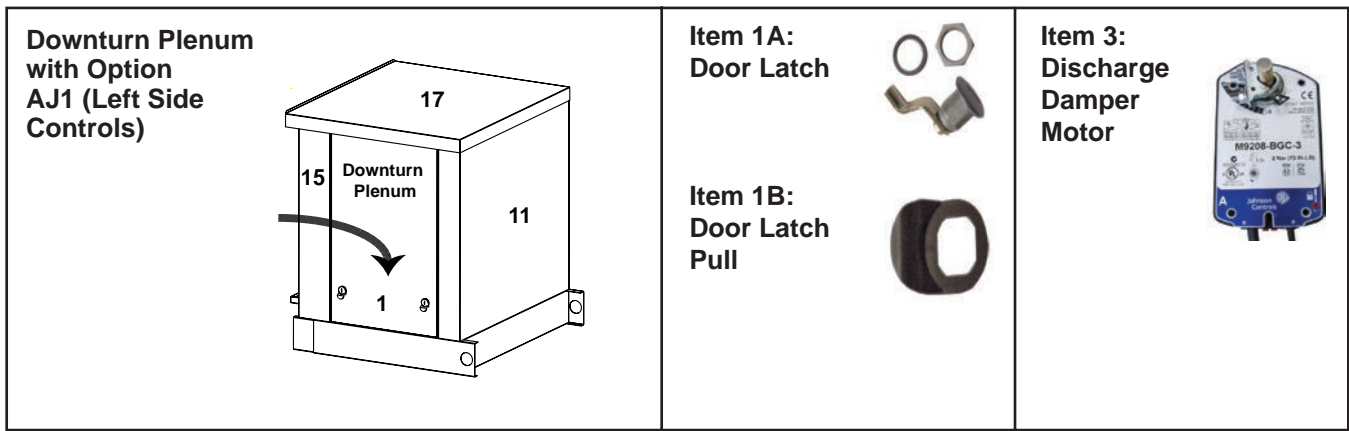


Figure 36. Option AQ5 or AQ8: Downturn Plenum for Bottom Discharge (Refer to Table 55)

Item No.	Component	Description	Control Side**	Unit Size					
				Model RDH	75, 100	125, 150	175, 200, 225	250, 300	350, 400A
				Model REH	10A, 20A, 40A	15B, 30B, 60B	—	30D, 60D, 90D, 120D	40E, 80E, 120E
				Model RXH	000A	000B	000C	000D	000E
				Model RHH*	—		130, 180	260	350
				PN (Quantity)**					
1	Slide-off door assembly	With insulation (AY3)	AJ1, AJ2	215062		215063			
		With high-density insulation (AY3H)		215064		215065			
1A	Door latch	204469 (2)							
1B	Pull tab	204470 (2)							
2	Discharge damper (option AQ8)	18.5 x 23 inches (not shown)		211420	—	211420	—		
		18.5 x 26.625 inches (not shown)		—	12634	—			
		18.5 x 34.875 inches (not shown)		—			15870	—	
		18.5 x 45.875 inches (not shown)		—			12640		
3	Motor	Discharge damper (option AQ8 with two-position discharge dampers)		209351					
4	Damper support	End (option AQ8) (not shown)		214362	214363	214362	214364	214365	
5		Side (option AQ8) (not shown)		214361 (2)					
6		Side (option AQ8) (not shown)		211218 (2)					
7		Top/bottom (option AQ8) (not shown)		211213 (2)	211214 (2)	211213 (2)	211215 (2)	211216 (2)	
8	Plenum	Bottom (not shown)		AJ1	214600	214601	214600	214602	214603
			AJ2	215449	215450	215449	215451	215452	
9	Liner	Plenum bottom (not shown)	AJ1, AJ2	214630	214631	214630	214632	214633	
10	Panel	End, inner (not shown)	AJ1	214604	214605	214606	214607	214608	
			AJ2	215453	215454	215455	215456	215457	
11	Panel	End, outer	AJ1	214621	214622	214623	214624	214625	
			AJ2	215470	215471	215472	215473	215474	
12	Wall	Side (not shown)	AJ1	214609		214610			
			AJ2	215458		215459			
13	Panel	Side, outer (not shown)	AJ1	214611		214612			
			AJ2	215460		215461			
14	Post (not shown)		AJ1	214613		214614			
			AJ2	215462		215463			
15	Panel	Post, outer	AJ1	214615		214616			
			AJ2	215464		215465			
16	Liner	Top (not shown)	AJ1	214617	214618	214617	214619	214620	
			AJ2	215466	215467	215466	215468	215469	
17	Panel	Top, outer	AJ1	214626	214627	214626	214628	214629	
			AJ2	215475	215476	215475	215477	215478	

*Cabinet C only for unit sizes 130 and 180, cabinet D only for unit size 260, and cabinet E only for unit size 350.
 **AJ1 = left side controls (when facing system discharge) and AJ2 = right side controls.
 ***Quantity is one (1) unless otherwise indicated.

DISCHARGE OPTION COMPONENTS—CONTINUED

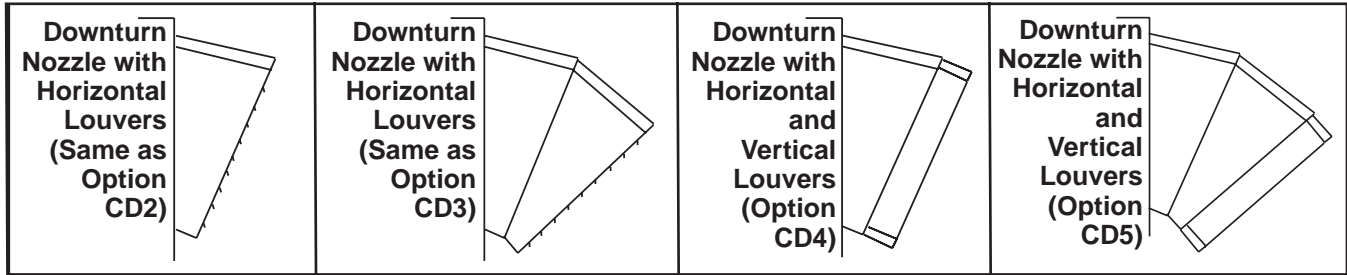


Figure 37. Downturn Discharge Nozzle Options

Table 56. Downturn Discharge Nozzle Assembly Components

Option	Models PDH and SDH Models PXH* Model SHH	Unit Size				
		75, 100	125, 150	175, 200, 225	250, 300	350, 400A
		000A	000B	000C	000D	000E
		—		130, 180	260	350
Component		PN (Quantity)**				
Same as option CD2	Nozzle kit, 25- to 65-degree, with horizontal louvers	213252	213253	213254	213255	213256
	Nozzle top	210800	210801	210802	210803	210804
	Nozzle bottom	210805	210806	210807	210808	210809
	Nozzle left side (left facing discharge)	210810		210811		
	Nozzle right side (right facing discharge)	210812		210813		
	Horizontal louver center support	—	212188	—	212189	212190
	Horizontal louver (refer to Table 53 for length)	201830 (4)	196231 (8)	196233 (7)	196231 (14)	201830 (14)
	Compression spring	195046 (4)	195046 (8)	195046 (7)	195046 (14)	195046 (14)
	Sheet metal screw, #8-18 x 3/8	195638 (25)	195638 (28)		195638 (35)	
Same as option CD3	Nozzle kit, 50- to 90-degree, with horizontal louvers	213257	213258	213259	213260	213261
	Nozzle top	210800 (2)	210801 (2)	210802 (2)	210803 (2)	210804 (2)
	Nozzle bottom	210805 (2)	210806 (2)	210807 (2)	210808 (2)	210809 (2)
	Nozzle left side (left facing discharge)	210810 (2)		210811 (2)		
	Nozzle right side (right facing discharge)	210812 (2)		210813 (2)		
	Horizontal louver center support	—	212188	—	212189	212190
	Horizontal louver (refer to Table 53 for length)	201830 (4)	196231 (8)	196233 (7)	196231 (14)	201830 (14)
	Compression spring	195046 (4)	195046 (8)	195046 (7)	195046 (14)	195046 (14)
	Sheet metal screw, #8-18 x 3/8	195638 (25)	195638 (28)		195638 (35)	
CD4	Nozzle kit, 25- to 65-degree, with horizontal and vertical louvers	213262	213263	213264	213265	213266
	Nozzle top	210800	210801	210802	210803	210804
	Nozzle bottom	210805	210806	210807	210808	210809
	Nozzle left side (left facing discharge)	210810		210811		
	Nozzle right side (right facing discharge)	210812		210813		
	Horizontal louver center support	—	212188	—	212189	212190
	Horizontal louver (refer to Table 53 for length)	201830 (4)	196231 (8)	196233 (7)	196231 (14)	201830 (14)
	Vertical louver frame side	210742 (2)		210743 (2)		
	Vertical louver frame support	210744 (2)	210745 (2)	210746 (2)	210747 (2)	210748 (2)
	Vertical louver (refer to Table 53 for length)	195314 (6)	195314 (9)	195578 (7)	195578 (9)	195578 (12)
	Compression spring	195046 (10)	195046 (17)	195046 (14)	195046 (23)	
	Sheet metal screw, #8-18 x 3/8	195638 (40)	195638 (45)		195638 (50)	
CD5	Nozzle kit, 50- to 90-degree, with horizontal and vertical louvers	213267	213268	213269	213270	213271
	Nozzle top	210800 (2)	210801 (2)	210802 (2)	210803 (2)	210804 (2)
	Nozzle bottom	210805 (2)	210806 (2)	210807 (2)	210808 (2)	210809 (2)
	Nozzle left side (left facing discharge)	210810 (2)		210811 (2)		
	Nozzle right side (right facing discharge)	210812 (2)		210813 (2)		
	Horizontal louver center support	—	212188	—	212189	212190
	Horizontal louver (refer to Table 53 for length)	201830 (4)	196231 (8)	196233 (7)	196231 (14)	201830 (14)
	Vertical louver frame side	210742 (2)		210743 (2)		
	Vertical louver frame support	210744 (2)	210745 (2)	210746 (2)	210747 (2)	210748 (2)
	Vertical louver (refer to Table 53 for length)	195314 (6)	195314 (9)	195578 (7)	195578 (9)	195578 (12)
	Compression spring	195046 (10)	195046 (17)	195046 (14)	195046 (23)	
	Sheet metal screw, #8-18 x 3/8	195638 (40)	195638 (45)		195638 (50)	

*Model PXH or RXH **without** hot water coil.

**Quantity is one (1) unless otherwise indicated.

***Model PXH or RXH **with** hot water coil.

Table 56. Downturn Discharge Nozzle Assembly Components—Continued

Option	Model PXH***	Unit Size				
		000A	000B	000C	000D	000E
Component		PN (Quantity)**				
Same as option CD2	Nozzle kit, 25- to 65-degree, with horizontal louvers	261335	261336	261337	261338	261339
	Nozzle top	260661	260662	260663	260664	260665
	Nozzle section bottom support	260670	260671	260672	260673	260674
	Nozzle left side (left facing discharge)	260666		260667		
	Nozzle right side (right facing discharge)	260668		260669		
	Horizontal louver center support	—	262020	—	262021	260660
	Horizontal louver (refer to Table 53 for length)	201251 (9)	201249 (18)	201251 (12)	201830 (24)	201250 (24)
	Compression spring	195046 (9)	195046 (18)	195046 (12)	195046 (24)	
	Offset stop for horizontal louvers	260658		260659		
	Sheet metal screw	11813 (35)				
Same as option CD3	Nozzle kit, 50- to 90-degree, with horizontal louvers	261340	261341	261342	261343	261344
	Nozzle top	260661 (2)	260662 (2)	260663 (2)	260664 (2)	260665 (2)
	Nozzle section bottom support	260670 (2)	260671 (2)	260672 (2)	260673 (2)	260674 (2)
	Nozzle left side (left facing discharge)	260666 (2)		260667 (2)		
	Nozzle right side (right facing discharge)	260668 (2)		260669 (2)		
	Horizontal louver center support	—	262020	—	262021	260660
	Horizontal louver (refer to Table 53 for length)	201251 (9)	201249 (18)	201251 (12)	201830 (24)	201250 (24)
	Compression spring	195046 (9)	195046 (18)	195046 (12)	195046 (24)	
	Offset stop for horizontal louvers	260658		260659		
	Sheet metal screw	11813 (45)				
CD4	Nozzle kit, 25- to 65-degree, with horizontal and vertical louvers	213262	213263	213264	213265	213266
	Nozzle top	260661	260662	260663	260664	260665
	Nozzle section bottom support	260670	260671	260672	260673	260674
	Nozzle left side (left facing discharge)	260666		260667		
	Nozzle right side (right facing discharge)	260668		260669		
	Horizontal louver center support	—	262020	—	262021	260660
	Horizontal louver (refer to Table 53 for length)	201251 (9)	201249 (18)	201251 (12)	201830 (24)	201250 (24)
	Offset stop for horizontal louvers	260658		260659		
	Vertical louvers (refer to Table 53 for length)	201251 (8)	201251 (12)	201249 (16)	201249 (28)	201249 (32)
	Vertical louver side support	260650 (2)		260651 (2)		
	Vertical louver top/bottom support	260646 (2)	260647 (2)	260646 (2)	260648 (2)	260649 (2)
	Center horizontal divider for vertical louvers	—		262011	262013	262012
	Compression spring	195046 (17)	195046 (35)	195046 (26)	195046 (56)	
Sheet metal screw	11813 (65)					
CD5	Nozzle kit, 50- to 90-degree, with horizontal and vertical louvers	213267	213268	213269	213270	213271
	Nozzle top	260661 (2)	260662 (2)	260663 (2)	260664 (2)	260665 (2)
	Nozzle section bottom support	260670 (2)	260671 (2)	260672 (2)	260673 (2)	260674 (2)
	Nozzle left side (left facing discharge)	260666 (2)		260667 (2)		
	Nozzle right side (right facing discharge)	260668 (2)		260669 (2)		
	Horizontal louver center support	—	262020	—	262021	260660
	Horizontal louver (refer to Table 53 for length)	201251 (9)	201249 (18)	201251 (12)	201830 (24)	201250 (24)
	Vertical louvers (refer to Table 53 for length)	201251 (8)	201251 (12)	201249 (16)	201249 (28)	201249 (32)
	Vertical louver side support	260650 (2)		260651 (2)		
	Vertical louver top/bottom support	260646 (2)	260647 (2)	260646 (2)	260648 (2)	260649 (2)
	Center horizontal divider for vertical louvers	—		262011	262013	262012
	Compression spring	195046 (10)	195046 (17)	195046 (14)	195046 (23)	
Sheet metal screw	11813 (65)					

*Model PXH or RXH **without** hot water coil.

**Quantity is one (1) unless otherwise indicated.

***Model PXH or RXH **with** hot water coil.

ROOF CURBS

NOTE: Roof curbs are listed in Table 57. Curb adapters (transition curb) are shown in Figure 38 and listed in Table 58.

Table 57. Roof Curb Assemblies (Models RDH, REH, RXH, and RHH)

			Component		PN		Quantity	
			Component		PN		Quantity	
Hardware and Tape Shipped with Each Roof Curb Assembly Package			Capscrew, 5/16-18 x 3/4-inch long		16247		12	
			Hex nut, 5/16-18		1035		12	
			Lag screw, 5/16 x 1-inch long		16243		4	
			Lockwasher, 5/16-inch		1333		16	
			Foam sealant tape, 1/4 x 1-1/4 x 50 inches		66302		1	
System Configuration	Roof Curb (CJ) Option	Size-Specific Roof Curb Assembly Package PN	Unit Size					
			Model RDH	75, 100	125, 150	175, 200, 225	250, 300	350, 400A
			Model REH	10A, 20A, 40A	15B, 30B, 60B	—	30D, 60D, 90D, 120D	40E, 80E, 120E
			Model RXH*	000A	000B	000C	000D	000E
			Component		PN (Quantity)			
Basic unit: blower and heat section or plenum cabinet	CJ8A	215047	End (front/rear)	215037 (2)	—	—	—	—
			Side (right/left)	215041 (2)				
		215048	End (front/rear)	—	215038 (2)	—	—	—
			Side (right/left)		215041 (2)			
		215049	End (front/rear)	—	—	215037 (2)	—	—
			Side (right/left)			215042 (2)		
		215050	End (front/rear)	—	—	—	215039 (2)	—
			Side (right/left)				215042 (2)	
		215051	End (front/rear)	—	—	—	—	215040 (2)
			Side (right/left)					215042 (2)
Basic unit plus one optional module: either downturn plenum or mixing box or cooling cabinet module without reheat (option AU5 or AU6)	CJ8B	215052	End (front/rear)	215037 (2)	—	—	—	
			Side (right/left)	215043 (2)				
		215053	End (front/rear)	—	215038 (2)	—	—	—
			Side (right/left)		215043 (2)			
		215054	End (front/rear)	—	—	215037 (2)	—	—
			Side (right/left)			215044 (2)		
		215055	End (front/rear)	—	—	—	215039 (2)	—
			Side (right/left)				215044 (2)	
		215056	End (front/rear)	—	—	—	—	215040 (2)
			Side (right/left)					215044 (2)
Basic unit plus cooling cabinet module with reheat (option AU7)	CJ8E	223750	End (front/rear)	215037 (2)	—	—	—	
			Side (right/left)	234940 (2)				
		223751	End (front/rear)	—	215038 (2)	—	—	—
			Side (right/left)		234940 (2)			
		223752	End (front/rear)	—	—	215037 (2)	—	—
			Side (right/left)			234941 (2)		
		223753	End (front/rear)	—	—	—	215039 (2)	—
			Side (right/left)				234941 (2)	
		223754	End (front/rear)	—	—	—	—	215040 (2)
			Side (right/left)					234941 (2)
Basic unit plus two optional modules: either downturn plenum and mixing box or cooling cabinet module without reheat (option AU5 or AU6) or mixing box and cooling cabinet module without reheat (option AU5 or AU6)	CJ8C	215057	End (front/rear)	215037 (2)	—	—	—	
			Side (right/left)	215045 (2)				
		215058	End (front/rear)	—	215038 (2)	—	—	—
			Side (right/left)		215045 (2)			
		215059	End (front/rear)	—	—	215037 (2)	—	—
			Side (right/left)			215046 (2)		
		215060	End (front/rear)	—	—	—	215039 (2)	—
			Side (right/left)				215046 (2)	
		215061	End (front/rear)	—	—	—	—	215040 (2)
			Side (right/left)					215046 (2)

*Model RXH **without** hot water coil.

Table 57. Roof Curb Assemblies (Models RDH, REH, RXH, and RHH)—Continued

System Configuration	Roof Curb (CJ) Option	Size-Specific Roof Curb Assembly Package PN	Model RDH	Unit Size						
				75, 100	125, 150	175, 200, 225	250, 300	350, 400A		
			Model REH	10A, 20A, 40A	15B, 30B, 60B	—	30D, 60D, 90D, 120D	40E, 80E, 120E		
			Model RXH*	000A	000B	000C	000D	000E		
			Component	PN (Quantity)						
Basic unit plus two optional modules: either downturn plenum and cooling cabinet module with reheat (option AU7) or mixing box and cooling cabinet module with reheat (option AU7)	CJ8F	223755	End (front/rear)	215037 (2)	—	—	—	—	—	
			Side (right/left)	234942 (2)						
		223756	End (front/rear)	—	215038 (2)	—	—	—	—	—
			Side (right/left)		234942 (2)					
		223757	End (front/rear)	—	—	215037 (2)	—	—	—	—
			Side (right/left)			234943 (2)				
		223758	End (front/rear)	—	—	—	215039 (2)	—	—	—
			Side (right/left)				234943 (2)			
		223759	End (front/rear)	—	—	—	—	—	215040 (2)	—
			Side (right/left)						234943 (2)	
Basic unit plus three optional modules: downturn plenum, mixing box, and cooling cabinet module without reheat (option AU5 or AU6)	CJ8D	214421	End (front/rear)	215037 (2)	—	—	—	—	—	
			Side (right/left)	216227 (2)						
		214422	End (front/rear)	—	215038 (2)	—	—	—	—	—
			Side (right/left)		216227 (2)					
		214423	End (front/rear)	—	—	215037 (2)	—	—	—	—
			Side (right/left)			216228 (2)				
		214424	End (front/rear)	—	—	—	215039 (2)	—	—	—
			Side (right/left)				216228 (2)			
		214425	End (front/rear)	—	—	—	—	—	215040 (2)	—
			Side (right/left)						216228 (2)	
Basic unit plus three optional modules: downturn plenum, mixing box, and cooling cabinet module with reheat (option AU7)	CJ8G	223760	End (front/rear)	215037 (2)	—	—	—	—	—	
			Side (right/left)	234944 (2)						
		223761	End (front/rear)	—	215038 (2)	—	—	—	—	—
			Side (right/left)		234944 (2)					
		223762	End (front/rear)	—	—	215037 (2)	—	—	—	—
			Side (right/left)			234945 (2)				
		223763	End (front/rear)	—	—	—	215039 (2)	—	—	—
			Side (right/left)				234945 (2)			
		223764	End (front/rear)	—	—	—	—	—	215040 (2)	—
			Side (right/left)						234945 (2)	
System Configuration	Roof Curb (CJ) Option	Size-Specific Roof Curb Assembly Package PN	Model RXH**	Unit Size						
			000A	000B	000C	000D	000E			
			Component	PN (Quantity)						
Basic unit with horizontal discharge	CJ8H	260877	End (front/rear)	261546 (2)	—	—	—	—	—	
			Side (right/left)	261522 (2)						
		260878	End (front/rear)	—	261547 (2)	—	—	—	—	—
			Side (right/left)		261522 (2)					
		260879	End (front/rear)	—	—	261546 (2)	—	—	—	—
			Side (right/left)			261523 (2)				
		260880	End (front/rear)	—	—	—	261548 (2)	—	—	—
			Side (right/left)				261523 (2)			
		260881	End (front/rear)	—	—	—	—	—	261549 (2)	—
			Side (right/left)						261523 (2)	

*Model RXH **without** hot water coil.

Model RXH **with hot water coil (option HW2).

ROOF CURBS—CONTINUED

Table 57. Roof Curb Assemblies (Models RDH, REH, RXH, and RHH)—Continued

System Configuration	Roof Curb (CJ) Option	Size-Specific Roof Curb Assembly Package PN	Model RXH**	Unit Size					
				000A	000B	000C	000D	000E	
				Component	PN (Quantity)				
Basic unit with horizontal discharge plus one optional module: either downturn discharge plenum (option AQ5 or AQ8) or mixing box (option MXB1) with horizontal discharge or cooling cabinet module without reheat (option AU5 or AU6)	CJ8J	260882	End (front/rear)	261546 (2)	—	—	—	—	
			Side (right/left)	261524 (2)					
		260883	End (front/rear)	—	261547 (2)	—	—	—	—
			Side (right/left)		261524 (2)				
		260884	End (front/rear)	—	—	261546 (2)	—	—	—
			Side (right/left)			261525 (2)			
		260885	End (front/rear)	—	—	—	—	261548 (2)	—
			Side (right/left)					261525 (2)	
		260886	End (front/rear)	—	—	—	—	—	261549 (2)
			Side (right/left)						261525 (2)
Basic unit with horizontal discharge plus two optional modules: either downturn discharge plenum (option AQ5 or AQ8) and mixing box or cooling cabinet module without reheat (option AU5 or AU6) or mixing box and cooling cabinet module without reheat (option AU5 or AU6)	CJ8K	260887	End (front/rear)	261546 (2)	—	—	—	—	
			Side (right/left)	261526 (2)					
		260888	End (front/rear)	—	—	261547 (2)	—	—	—
			Side (right/left)			261526 (2)			
		260889	End (front/rear)	—	—	261546 (2)	—	—	—
			Side (right/left)			261527 (2)			
		260890	End (front/rear)	—	—	—	—	261548 (2)	—
			Side (right/left)					261527 (2)	
		260891	End (front/rear)	—	—	—	—	—	261549 (2)
			Side (right/left)						261527 (2)
Basic unit plus three optional modules: downturn discharge plenum (option AQ5 or AQ8), mixing box (option MXB1), and cooling cabinet module without reheat (option AU5 or AU6)	CJ8L	260892	End (front/rear)	261546 (2)	—	—	—	—	
			Side (right/left)	261528 (2)					
		260893	End (front/rear)	—	—	261547 (2)	—	—	—
			Side (right/left)			261528 (2)			
		260894	End (front/rear)	—	—	261546 (2)	—	—	—
			Side (right/left)			261529 (2)			
		260895	End (front/rear)	—	—	—	—	261548 (2)	—
			Side (right/left)					261529 (2)	
		260896	End (front/rear)	—	—	—	—	—	261549 (2)
			Side (right/left)						261529 (2)
Basic unit with horizontal discharge plus cooling cabinet module with reheat (option AU7)	CJ8M	260897	End (front/rear)	261546 (2)	—	—	—	—	
			Side (right/left)	261530 (2)					
		260898	End (front/rear)	—	—	261547 (2)	—	—	—
			Side (right/left)			261530 (2)			
		260899	End (front/rear)	—	—	261546 (2)	—	—	—
			Side (right/left)			261531 (2)			
		260900	End (front/rear)	—	—	—	—	261548 (2)	—
			Side (right/left)					261531 (2)	
		260901	End (front/rear)	—	—	—	—	—	261549 (2)
			Side (right/left)						261531 (2)
Basic unit with horizontal discharge plus two optional modules: cooling cabinet module with reheat (option AU7) and either downturn discharge plenum (option AQ5 or AQ8) or mixing box (option MXB1)	CJ8N	260902	End (front/rear)	261546 (2)	—	—	—	—	
			Side (right/left)	261532 (2)					
		260903	End (front/rear)	—	—	261547 (2)	—	—	—
			Side (right/left)			261532 (2)			
		260904	End (front/rear)	—	—	261546 (2)	—	—	—
			Side (right/left)			261458 (2)			
		260905	End (front/rear)	—	—	—	—	261548 (2)	—
			Side (right/left)					261458 (2)	
		260906	End (front/rear)	—	—	—	—	—	261549 (2)
			Side (right/left)						261458 (2)

*Model RXH **without** hot water coil.

Model RXH **with hot water coil (option HW2).

Table 57. Roof Curb Assemblies (Models RDH, REH, RXH, and RHH)—Continued

System Configuration	Roof Curb (CJ) Option	Size-Specific Roof Curb Assembly Package PN	Model RXH**	Unit Size				
				000A	000B	000C	000D	000E
				PN (Quantity)				
Basic unit plus three optional modules: downturn discharge plenum (option AQ5 or AQ8), mixing box (option MXB1), and cooling cabinet module with reheat (option AU7)	CJ8P	260907	End (front/rear)	261546 (2)	—	—	—	—
			Side (right/left)	261459 (2)				
		260908	End (front/rear)	—	261547 (2)	—	—	—
			Side (right/left)		261459 (2)			
		260909	End (front/rear)	—	—	261546 (2)	—	—
			Side (right/left)			261545 (2)		
		260910	End (front/rear)	—	—	—	261548 (2)	—
			Side (right/left)				261545 (2)	
		260911	End (front/rear)	—	—	—	—	261549 (2)
			Side (right/left)				261545 (2)	
System Configuration	Roof Curb (CJ) Option	Size-Specific Roof Curb Assembly Package PN	Model RHH		Unit Size			
			Component		130, 180	260	350	
			PN (Quantity)					
Basic unit	CJ8Q	263910	End (front/rear)	261546 (2)	—	—		
			Side (right/left)	263425 (2)				
		263911	End (front/rear)	—	261548 (2)	—		
			Side (right/left)		263425 (2)			
		263912	End (front/rear)	—	—	261549 (2)		
			Side (right/left)		263425 (2)			
Basic unit with horizontal discharge plus one optional module: either downturn discharge plenum (option AQ5 or AQ8) or mixing box (option MXB1) or cooling cabinet module without reheat (option AU5 or AU6)	CJ8R	263913	End (front/rear)	261546 (2)	—	—		
			Side (right/left)	263426 (2)				
		263914	End (front/rear)	—	261548 (2)	—		
			Side (right/left)		263426 (2)			
		263915	End (front/rear)	—	—	261549 (2)		
			Side (right/left)		263426 (2)			
Basic unit with horizontal discharge plus two optional modules: either downturn discharge plenum (option AQ5 or AQ8) and either mixing box or cooling cabinet module without reheat (option AU5 or AU6) or mixing box and cooling cabinet module without reheat (option AU5 or AU6)	CJ8S	263916	End (front/rear)	261546 (2)	—	—		
			Side (right/left)	263427 (2)				
		263917	End (front/rear)	—	261548 (2)	—		
			Side (right/left)		263427 (2)			
		263918	End (front/rear)	—	—	261549 (2)		
			Side (right/left)		263427 (2)			
Basic unit plus three optional modules: downturn discharge plenum (option AQ5 or AQ8), mixing box (option MXB1), and cooling cabinet module without reheat (option AU5 or AU6)	CJ8T	263919	End (front/rear)	261546 (2)	—	—		
			Side (right/left)	263428 (2)				
		263920	End (front/rear)	—	261548 (2)	—		
			Side (right/left)		263428 (2)			
		263921	End (front/rear)	—	—	261549 (2)		
			Side (right/left)		263428 (2)			
Basic unit with horizontal discharge plus cooling cabinet module with reheat (option AU7)	CJ8U	263922	End (front/rear)	261546 (2)	—	—		
			Side (right/left)	263429 (2)				
		263923	End (front/rear)	—	261548 (2)	—		
			Side (right/left)		263429 (2)			
		263924	End (front/rear)	—	—	261549 (2)		
			Side (right/left)		263429 (2)			
*Model RXH without hot water coil.								
**Model RXH with hot water coil (option HW2).								

ROOF CURBS—CONTINUED

Table 57. Roof Curb Assemblies (Models RDH, REH, RXH, and RHH)—Continued							
System Configuration	Roof Curb (CJ) Option	Size-Specific Roof Curb Assembly Package PN	Model RHH	Unit Size			
			Component	130, 180	260	350	
				PN (Quantity)			
Basic unit plus two optional modules: cooling cabinet module with reheat (option AU7) and either downturn discharge plenum (option AQ5 or AQ8) or mixing box (option MXB1)	CJ8V	263925	End (front/rear)	261546 (2)	—	—	
			Side (right/left)	263430 (2)	—		
		263926	End (front/rear)	—	261548 (2)	—	261549 (2)
			Side (right/left)		263430 (2)		
		263927	End (front/rear)	—	—	—	261549 (2)
			Side (right/left)		—	—	263430 (2)
Basic unit plus three optional modules: downturn discharge plenum (option AQ5 or AQ8), mixing box (option MXB1), and cooling cabinet module with reheat (option AU7)	CJ8W	263928	End (front/rear)	261546 (2)	—	—	
			Side (right/left)	263431 (2)	—		
		263929	End (front/rear)	—	261548 (2)	—	261549 (2)
			Side (right/left)		263431 (2)		
		263930	End (front/rear)	—	—	—	261549 (2)
			Side (right/left)		—	—	263431 (2)

*Model RXH **without** hot water coil.

Model RXH **with hot water coil (option HW2).

NOTE: A curb adapter (transition curb) is required when installing a model RDH, REH, or RXH unit on an existing CJ option roof curb. Transition curbs feature heavy-gauge G-90 galvanized steel, fully seam-welded (air- and water-tight) welds coated with rust inhibitor, internal insulation (with 2 insulation), and gasketing provided for field installation.

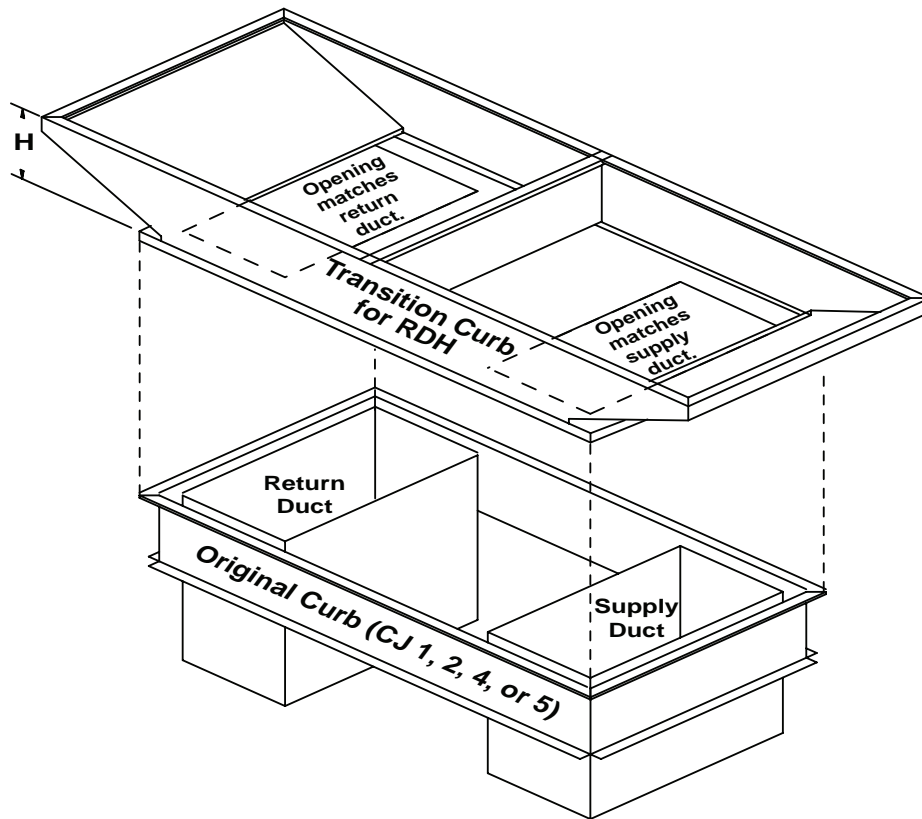


Figure 38. Curb Adapter (Transition Curb)

Table 58. Curb Adapters

Model RDH, REH, or RXH System Configuration	Model RGB or RPB Inlet Air Configuration	Roof Curb (CJ) Option	Unit Size			Model RGB or RPB Unit Size with Existing Roof Curb	Curb Adapter		
			Model RDH	Model REH	Model RXH		Manufacturer's Model No.	PN	Height (inches (mm))
Basic unit with horizontal discharge	Horizontal (no damper)	CJ1	75, 100	10A, 20A, 40A	000A	75, 100, 125	RSI 63-290-PA-01	216516	8 (203)
			125, 150	15B, 30B, 60B	000B	125	RSI 63-290-PB-01	216520	
			150, 175			150, 175	RSI 63-290-PB-02	216524	
			175, 200, 225	—	000C	175	RSI 63-290-PC-01	216528	10 (254)
			200, 225			200, 225	RSI 63-290-PC-02	216532	
			250, 300	30D, 60D, 90D, 120D	000D	250, 300	RSI 63-290-PD-01	216536	8 (203)
350, 400A	40E, 80E, 120E	000E	350			350	RSI 63-290-PE-01	216540	
			400			400	RSI 63-290-PE-02	216544	
Basic unit with horizontal discharge plus mixing box	Horizontal with damper or bottom or horizontal and bottom		All			All	Special order—contact your factory distributor		
Basic unit with bottom discharge plus downturn discharge plenum	Horizontal (no damper)	CJ2	75, 100	10A, 20A, 40A	000A	75, 100, 125	RSI 63-290-PA-02	216517	8 (203)
			125, 150	15B, 30B, 60B	000B	125	RSI 63-290-PB-03	216521	
			150, 175			150, 175	RSI 63-290-PB-04	216525	
			175, 200, 225	—	000C	175	RSI 63-290-PC-03	216529	10 (254)
			200, 225			200, 225	RSI 63-290-PC-04	216533	
			250, 300	30D, 60D, 90D, 120D	000D	250, 300	RSI 63-290-PD-02	216537	13 (330)
350, 400A	40E, 80E, 120E	000E	350			350	RSI 63-290-PE-03	216541	
			400			400	RSI 63-290-PE-04	216545	
Basic unit with bottom discharge plus mixing box and downturn discharge plenum	Horizontal with damper or bottom or horizontal and bottom	CJ2	75, 100	10A, 20A, 40A	000A	75, 100, 125	RSI 63-290-PA-05	220906	13 (330)
			125, 150	15B, 30B, 60B	000B	125	RSI 63-290-PB-09	220907	
			150, 175			150, 175	RSI 63-290-PB-10	220908	
			175, 200, 225	—	000C	175	RSI 63-290-PC-09	220909	15 (381)
			200, 225			200, 225	RSI 63-290-PC-10	220910	
			250, 300	30D, 60D, 90D, 120D	000D	250, 300	RSI 63-290-PD-05	220911	16 (406)
350, 400A	40E, 80E, 120E	000E	350			350	RSI 63-290-PE-09	220912	
			400			400	RSI 63-290-PE-10	220913	
Basic unit with horizontal discharge plus cooling cabinet	Horizontal (no damper)		All			All	Special order—contact your factory distributor		
Basic unit with horizontal discharge plus mixing box and cooling cabinet	Horizontal with damper or bottom or horizontal and bottom	CJ4	75, 100	10A, 20A, 40A	000A	75, 100, 125	RSI 63-290-PA-03	216518	10 (254)
			125, 150	15B, 30B, 60B	000B	125	RSI 63-290-PB-05	216522	
			150, 175			150, 175	RSI 63-290-PB-06	216526	
			175, 200, 225	—	000C	175	RSI 63-290-PC-05	216530	13 (330)
			200, 225			200, 225	RSI 63-290-PC-06	216534	
			250, 300	30D, 60D, 90D, 120D	000D	250, 300	RSI 63-290-PD-03	216538	10 (254)
350, 400A	40E, 80E, 120E	000E	350			350	RSI 63-290-PE-05	216542	
			400			400	RSI 63-290-PE-06	216546	
Basic unit with bottom discharge plus cooling cabinet and downturn discharge plenum	Horizontal (no damper)		All			All	Special order—contact your factory distributor		
Basic unit with bottom discharge plus mixing box and cooling cabinet and downturn discharge plenum	Horizontal with damper or horizontal and bottom	CJ5	75, 100	10A, 20A, 40A	000A	75, 100, 125	RSI 63-290-PA-04	216519	10 (254)
			125, 150	15B, 30B, 60B	000B	125	RSI 63-290-PB-07	216523	
			150, 175			150, 175	RSI 63-290-PB-08	216527	
			175, 200, 225	—	000C	175	RSI 63-290-PC-07	216531	13 (330)
			200, 225			200, 225	RSI 63-290-PC-08	216535	
			250, 300	30D, 60D, 90D, 120D	000D	250, 300	RSI 63-290-PD-04	216539	10 (254)
350, 400A	40E, 80E, 120E	000E	350			350	RSI 63-290-PE-07	216543	
			400			400	RSI 63-290-PE-08	216547	

CABINET COMPONENTS

NOTE:

- Not all cabinet parts are listed with replacement PNs. If a required part is not listed, contact your Factory Representative.
- Common cabinet components and configurations are shown in [Figure 39](#) and listed in [Table 59](#). Most cabinet parts listed are without insulation. If insulation is required, specify on the order. Original order option codes for insulation are explained in [Table 59](#).
- Cabinet components for outdoor models RDH and RXH are shown in [Figure 40](#) and listed in [Table 60](#).
- Cabinet components for indoor models PDH and PXH are shown in [Figure 41](#) and listed in [Table 61](#).
- Cabinet components for indoor model SDH are shown in [Figure 42](#) and listed in [Table 62](#).
- Cabinet components for indoor model PEH are shown in [Figure 43](#) and listed in [Table 63](#) and [Table 64](#).
- Cabinet components for outdoor model REH are shown in [Figure 44](#) and listed in [Table 65](#) and [Table 66](#).
- Cabinet components for indoor model SHH are shown in [Figure 45](#) and listed in [Table 67](#).
- Cabinet components for outdoor model RHH are shown in [Figure 46](#) and listed in [Table 68](#).

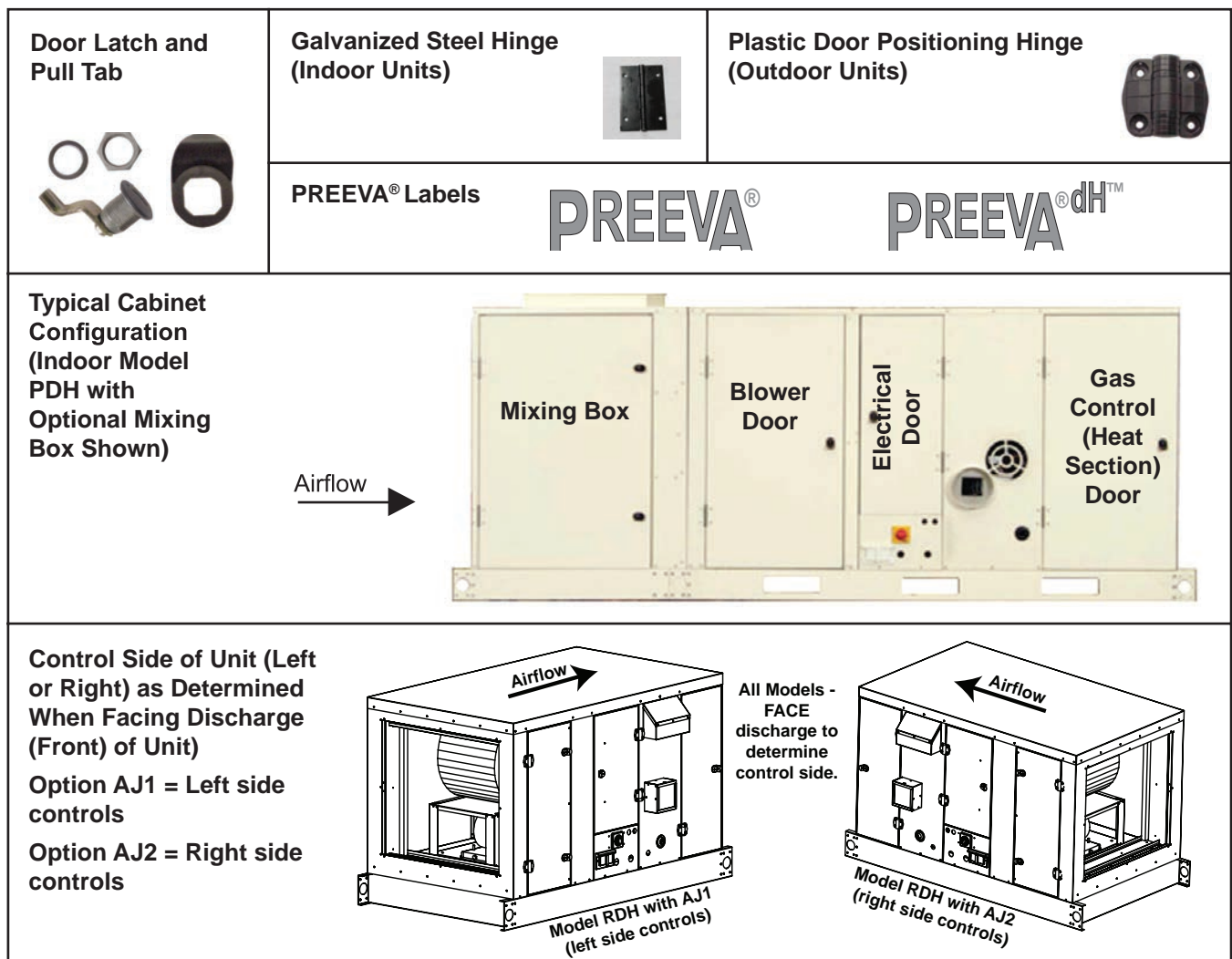


Figure 39. Common Cabinet Components and Configurations (Refer to [Table 59](#))

Component	Description	All Models and Unit Sizes	
		PN	
Door latch	—	204469	
Pull tab	—	204470	
Hinge (indoor units)	Galvanized steel	210029	
Hinge (outdoor units)	Door-positioning, plastic	158800	
PREEVA® label	Standard	234658	
	dH	234660	
Touchup paint (not shown)	Cabinet, 11-ounce spray can (white)	201805	
	Louver, 12-ounce spray can (maroon)	207432	
Insulation Option Code		Explanation	
AY1	Single-wall without insulation		
AY2	Single-wall with insulation		
AY3	Double-wall with insulation		
AY3H	Double-wall with high-density insulation		

NOTE: Cabinet components for model RXH (without hydronic heat) units are the same as for model RDH units except for the plenum cabinet in place of the heat section. If parts are needed that cannot be identified here, contact your Factory Representative.

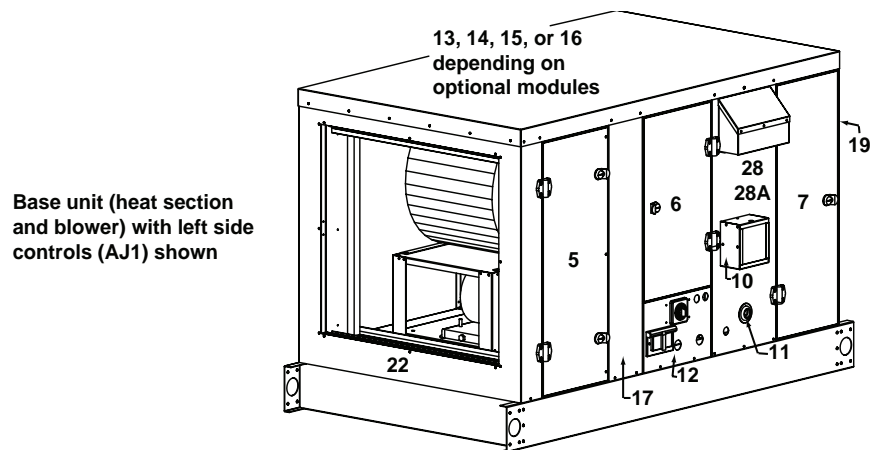


Figure 40. Cabinet Components—Outdoor Models RDH and RXH (Refer to Table 60)

Item No.	Component	Description	Model RDH Control Side*	Unit Size				
				75, 100	125, 150	175, 200, 225	250, 300	350, 400A
				PN (Quantity)**				
1	Filter track***	Assembly, top (not shown)	AJ1, AJ2	210873	210874	—		
1A		Bottom (not shown)		210084	210085	—		
2	Filter rack***	Assembly (not shown)		—	—	210870	210871	210872
3	Filter stop***	Assembly (not shown)		—	212200	—	212201	
4	Angle***	Filter rack (not shown)		210080	210081	210080	210082	210083
5	Blower door assembly	AY3 insulation		214178	214179			
		AY3H insulation		214180	214181			
6	Door	Electrical, assembly		214182	214183			
		Gas control, assembly		214176	214177			
8	Outlet collar	Inside vent box (not shown)		195077	196640			
9	Mounting plate	Vent box, behind vent box (not shown)		215163	215164			
10	Vent box	Assembly		215169	215170			
11	Grommet			102607				
12	Panel	Field power connection		214151				

*AJ1 = left side controls (when facing system discharge) and AJ2 = right side controls.
**Quantity is one (1) unless otherwise indicated.
***With filters (AW2-21). If unit is equipped with cooling coil cabinet, filter rack and filters are in cooling coil cabinet.

CABINET COMPONENTS—CONTINUED

Table 60. Cabinet Components (Outdoor Models RDH and RXH)—Continued								
Item No.	Component	Model RDH		Unit Size				
				75, 100	125, 150	175, 200, 225	250, 300	350, 400A
		Description	Control Side*	PN (Quantity)**				
13	Top	For base unit only	AJ1	214172	214173	214174	214175	—
			AJ2	215445	215446	215447	215448	
		For unit with mixing box or cooling cabinet	AJ1	214375	214376	214377	214378	
			AJ2	215529	215530	215531	215532	
14	Liner	Top, base unit	AJ1	214111	214112	214113	214114	214115
			AJ2	215399	215400	215401	215402	215403
15	Top (front/rear)	For blower/heat section only	AJ1	—	—	—	—	214167
			AJ2					214168
		For unit with mixing box or cooling cabinet	AJ1					215441
			AJ2					215442
		AJ1	214167					
		AJ2	214379					
16	Top splice	Assembly	AJ1	—	—	—	—	215441
			AJ2					215533
17	Panel	Center control post, outer	AJ1	214145	214146	214146	214146	214146
			AJ2	215433	215434	215434	215434	
18	Control post	Center (not shown)	AJ1	214143	214144	214144	214144	214144
			AJ2	215431	215432	215432	215432	
19	Panel	Front	AJ1	214121	214122	214123	214124	214125
			AJ2	215409	215410	215411	215412	215413
20	Panel	Right side, solid, outer (not shown)	AJ1	214138	214139	214140	214140	214140
			AJ2	215426	215427	215428	215428	
21	Panel	Blower right side, inner (not shown)	AJ1	214131	214132	214132	214132	214132
			AJ2	215419	215420	215420	215420	
22	Panel	Inlet end, outer	AJ1	214133	214134	214135	214136	214137
			AJ2	215421	215422	215423	215424	215425
23	Panel	Inlet end, inner (not shown)	AJ1	214126	214127	214128	214129	214130
			AJ2	215414	215415	215416	215417	215418
24	Panel frame	Inlet end, inner, top/bottom (not shown)	AJ1, AJ2	214161 (2)	214164 (2)	214161 (2)	214165 (2)	214166 (2)
25		Inlet end, sides (not shown)		214162 (2)	214163 (2)	214163 (2)	214163 (2)	
26	Discharge top	Not shown	AJ1, AJ2	215554	215555	215556	215557	215558
27	Liner	Heat exchanger top (not shown)	AJ1	214116	214117	214118	214119	214120
			AJ2	215404	215405	215406	215407	215408
28	Post	Field connection, assembly, includes hood	AJ1	215123	215124	260332	260332	260332
			AJ2	215968	215124	215124	215124	
28A	Hood	Intake	AJ1, AJ2	213633	213634	213634	213634	213634

*AJ1 = left side controls (when facing system discharge) and AJ2 = right side controls.

**Quantity is one (1) unless otherwise indicated.

***With filters (AW2-21). If unit is equipped with cooling coil cabinet, filter rack and filters are in cooling coil cabinet.

NOTE: Cabinet components for model PXH (without hydronic heat) units are the same as for model PDH units except for the plenum cabinet in place of the heat section. If parts are needed that cannot be identified here, contact your Factory Representative.

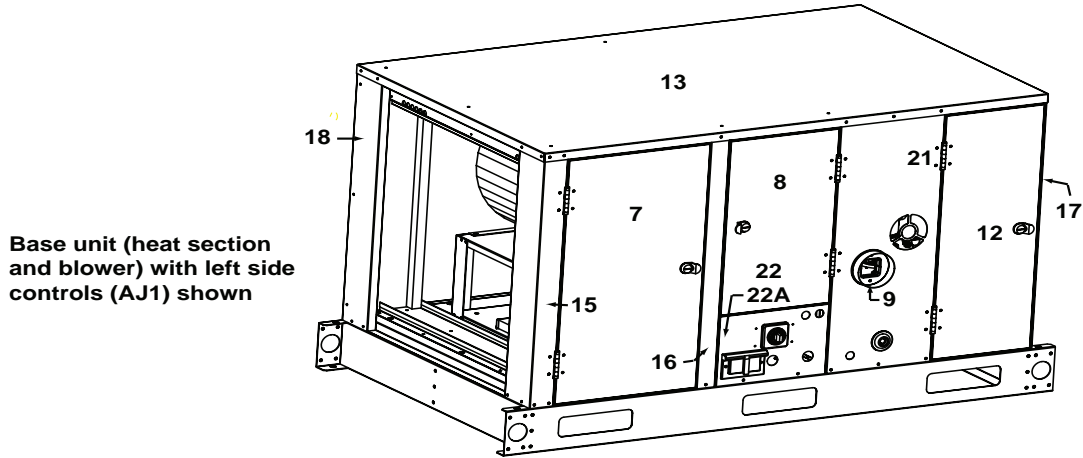


Figure 41. Cabinet Components—Outdoor Models PDH and PXH (Refer to Table 61)

Table 61. Cabinet Components (Outdoor Models PDH and PXH)									
Item No.	Component	Description	Model PDH	Unit Size					
				75, 100	125, 150	175, 200, 225	250, 300	350, 400A	
				PN (Quantity)**					
1	Filter track***	Assembly, top (not shown)	AJ1, AJ2	210873	210874	—			
2		Bottom (not shown)		210084	210085	—			
3	Filter rack***	Assembly (not shown)		—	210870	210871	210872	—	
4		Side (not shown)		210731		210732			
5	Filter stop***	Assembly (not shown)		—	212200	—	212201		
6	Angle***	Filter rack (not shown)		210080	210081	210080	210082	210083	
7	Blower door assembly	AY2 insulation		210845		210846			
		AY3 insulation		210847		210848			
		AY3H insulation		213361		213362			
8	Door assembly	Electrical		210849		210850			
9	Outlet collar			195077	195079	196640	195662		
10	Gasket	Outlet collar (not shown)	170048		196822	207732			
11	Grommet (not shown)		102607		15021				
12	Door assembly	Gas control	AJ1	210851		210852			
			AJ2	212238		212239			
13	Top		AJ1	210071	210072	210073	210074	210728 210729	
			AJ2	210993	210994	210995	210996	211468 211467	
14	Liner	Top, with insulation only (not shown)	AJ1	210778	210779	210780	210781	210782	
			AJ2	211475	211476	211477	211478	211479	
15	Rear corner (not shown)		AJ1	210054		210055			
			AJ2	210974		210975			
16	Adapter leg	Center	AJ1	210056		210057			
			AJ2	210976		210977			
17		Front	AJ1	210060	210061	210062	210063	210064	
			AJ2	210981	210982	210983	210984	210985	
18	Panel	Right side and corner (not shown)	AJ1	210065		210612	210613		
		Left side and corner (not shown)	AJ2	210986		210987	210988		
19	Discharge top	Not shown	AJ1, AJ2	210628	210629	210630	210631	210632	

*AJ1 = left side controls (when facing system discharge) and AJ2 = right side controls.
 **Quantity is one (1) unless otherwise indicated.
 ***With filters (AW2-21). If unit is equipped with cooling coil cabinet, filter rack and filters are in cooling coil cabinet.

CABINET COMPONENTS—CONTINUED

Table 61. Cabinet Components (Outdoor Models PDH and PXH)—Continued								
Item No.	Component	Description	Model PDH	Unit Size				
				75, 100	125, 150	175, 200, 225	250, 300	350, 400A
				PN (Quantity)**				
20	Liner	Heat exchanger top (not shown)	AJ1	210620	210621	210622	210623	210624
			AJ2	211429	211430	211431	211432	211433
21	Post	Field connection	AJ1	210608	210609	210610		
			AJ2	210978	210979	210980		
22	Panel	Field connection	AJ1	210769				
			AJ2	211469				
22A	Plate	Outlet cover	AJ1, AJ2	209001				

*AJ1 = left side controls (when facing system discharge) and AJ2 = right side controls.
 **Quantity is one (1) unless otherwise indicated.
 ***With filters (AW2-21). If unit is equipped with cooling coil cabinet, filter rack and filters are in cooling coil cabinet.

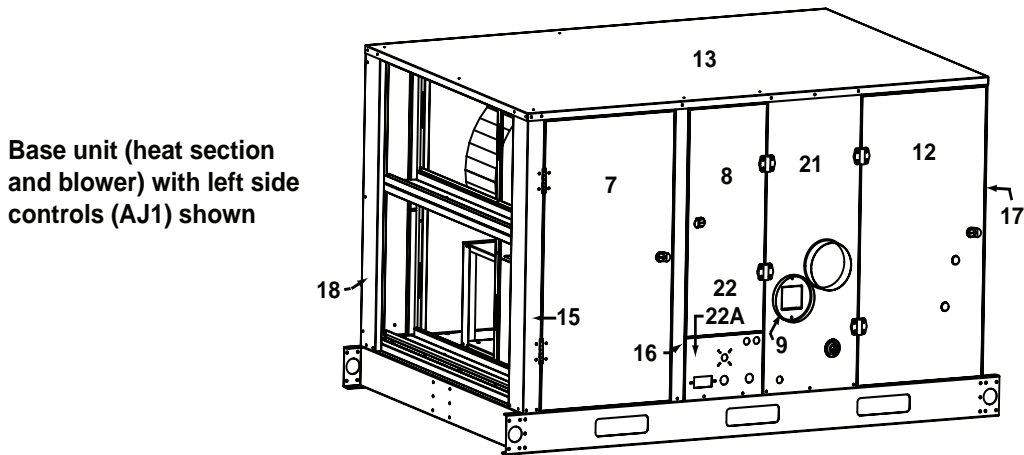


Figure 42. Cabinet Components—Indoor Model SDH (Refer to Table 62)

Table 62. Cabinet Components (Indoor Model SDH)									
Item No.	Component	Description	Model SDH	Unit Size					
				75, 100	125, 150	175, 200, 225	250, 300	350, 400A	
				PN					
1	Filter track***	Assembly, top (not shown)	AJ1, AJ2	210873	210874	—			
2		Bottom (not shown)		210084	210085	—			
3	Filter rack***	Assembly (not shown)		—	210870	210871	210872	—	
4		Side (not shown)		210731		210732			
5	Filter stop***	Assembly (not shown)		—	212200	—	212001		
6	Angle***	Filter rack (not shown)		210080	210081	210080	210082	210083	
7	Blower door assembly	AY1 or AY2 insulation		210845	210846				
		AY3 insulation		210847	210848				
		AY3H insulation		213361	213362				
8	Door assembly	Electrical		212242		212243			
9	Outlet collar			195077	195079	196640	195662		
10	Gasket	Outlet collar (not shown)		170048		196822	207732		
11	Grommet (not shown)		102607			15021			
12	Door assembly	Gas control	AJ1	212236		212237			
			AJ2	212238		212239			

*AJ1 = left side controls (when facing system discharge) and AJ2 = right side controls.
 **Quantity is one (1) unless otherwise indicated.
 ***With filters (AW2-21). If unit is equipped with cooling coil cabinet, filter rack and filters are in cooling coil cabinet.

Table 62. Cabinet Components (Indoor Model SDH)—Continued

Item No.	Component	Description	Model SDH Control Side*	Unit Size				
				75, 100	125, 150	175, 200, 225	250, 300	350, 400A
				PN				
13	Top		AJ1	210071	210072	210073	210074	210728 210729
			AJ2	210993	210994	210995	210996	211468 211467
14	Liner	Top, with insulation only (not shown)	AJ1	210778	210779	210780	210781	210782
			AJ2	211475	211476	211477	211478	211479
15	Rear corner		AJ1	210054		210055		
			AJ2	210974		210975		
16	Adapter leg	Center	AJ1	210056		210057		
			AJ2	210976		210977		
17	Panel	Front	AJ1	210060	210061	210062	210063	210064
			AJ2	210981	210982	210983	210984	210985
18	Panel	Right side and corner	AJ1	210065		210612	210613	
		Left side and corner (not shown)	AJ2	210986		210987	210988	
19	Discharge top	Not shown	AJ1, AJ2	210628	210629	210630	210631	210632
20	Liner	Heat exchanger top (not shown)	AJ1	210620	210621	210622	210623	210624
			AJ2	211429	211430	211431	211432	211433
21	Post	Field connection, assembly, includes inlet collar	AJ1	212244	212245	259683		
			AJ2	213381	213382	259723		
22	Panel	Field connection	AJ1	210769				
			AJ2	211469				
22A	Plate	Outlet cover	AJ1, AJ2	209001				

*AJ1 = left side controls (when facing system discharge) and AJ2 = right side controls.

**Quantity is one (1) unless otherwise indicated.

***With filters (AW2-21). If unit is equipped with cooling coil cabinet, filter rack and filters are in cooling coil cabinet.

Base unit (electric heat section and blower) with left side controls (AJ1) shown

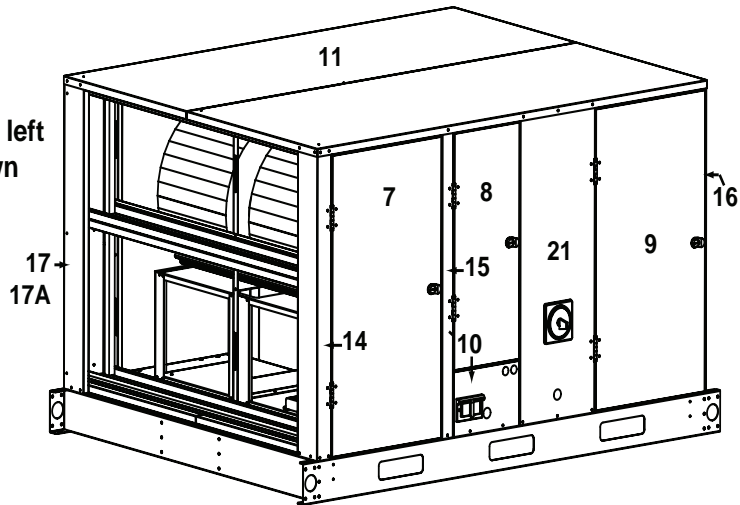


Figure 43. Cabinet Components—Indoor Model PEH (Refer to Table 63 and Table 64)

CABINET COMPONENTS—CONTINUED

Table 63. Cabinet Components (Indoor Model PEH, Unit Sizes 10A–60B)

Item No.	Component	Model PEH		Unit Size						
				10A	20A	40A	15B	30B	60B	
		Description	Control Side*	PN						
1	Filter track	Assembly, top (not shown)	AJ1, AJ2	210873			210874			
2		Bottom (not shown)		210084			210085			
3	Filter rack	Assembly (not shown)		Not used on unit sizes 10A–60B						
4		Side (not shown)		210731						
5	Angle	Filter rack (not shown)		210080			210081			
6	Filter stop	Assembly (not shown)		—			212200			
7	Blower door assembly	AY2 insulation		210845						
		AY3 insulation		210847						
		AY3H insulation		213361						
8	Door assembly	Electrical		210849						
9		Heat section	255524							
10	Power panel	Auxiliary	223644							
11	Liner	Top	AJ1	223621			223632			
				210778			210779			
			AJ2	254112			254113			
				211475			211476			
12	Discharge side	Left (not shown)	AJ1	210616						
			AJ2	254104						
Right (not shown)		AJ1	223590			210618				
		AJ2	254110							
14	Liner	Rear corner	AJ1	210054						
				210773						
			AJ2	210974						
				210773						
15	Adapter leg	Center	AJ1	223730						
				210771						
			AJ2	210976						
				211470						
16	Panel	Front	AJ1	210060			210061			
			AJ2	210981			210982			
17		Right side	AJ1	210065						
17A	Liner	Right side corner	AJ1	210775						
18	Panel	Left side (not shown)	AJ2	210986						
18A	Liner	Left side corner (not shown)	AJ2	211472						
19	Discharge top	Not shown	AJ1, AJ2	210628			210629			
20	Liner	Electrical top (not shown)	AJ1	221729			221730			
			AJ2	254106			254107			
21	Field supply power post assembly	208V/1PH/60Hz (option AK2)	AJ1	221735	254196	—	254197	254196	—	
			AJ2	254117	235077		235077	235078		
		230V/1PH/60Hz (option AK3)	AJ1	254196	254197	—	254197	254196	—	
			AJ2	235077	235078		235077	235078		
		208V/3PH/60Hz (option AK5)	AJ1	—	221735	254196	—	254197	254196	
			AJ2		254117	235077		235077	235078	
		230V/1PH/60Hz (option AK6)	AJ1		221735	254197		—	254197	254196
			AJ2		254117	235078			235077	235078
		460V/3PH/60Hz (option AK7)	AJ1		221735			—	221735	254197
			AJ2		254117				254117	235077
		575V/3PH/60Hz (option AK8)	AJ1		221735			—	221735	254197
			AJ2		254117				254117	235077

*AJ1 = left side controls (when facing system discharge) and AJ2 = right side controls.

Table 64. Cabinet Components (Indoor Model PEH, Unit Sizes 30D–120E)

Item No.	Component	Model PEH		Unit Size						
		Description	Control Side*	30D	60D	90D	120D	40E	80E	120E
				PN						
1	Filter track	Assembly, top (not shown)	AJ1, AJ2	Not used on unit sizes 30D–120E						
2		Bottom (not shown)								
3	Filter rack	Assembly (not shown)		210871			210872			
4		Side (not shown)		210732						
5	Angle	Filter rack (not shown)		210082			210083			
6	Filter stop	Assembly (not shown)		212201						
7	Blower door assembly	AY2 insulation		210846						
		AY3 insulation		210848						
		AY3H insulation		213362						
8	Door assembly	Electrical		210850						
		Heat section	255525							
9										
10	Power panel	Auxiliary	223644							
11	Liner	Top	AJ1	223623			223625 (control side)			
				210781			210728 (non-control side)			
			254114			210782 (liner)				
			AJ2	211478			254115 (control side)			
				210728 (non-control side)						
			211479 (liner)							
12	Discharge side	Left (not shown)	AJ1	210617						
			AJ2	254105						
Right (not shown)		AJ1	210619							
		AJ2	254111							
14	Liner	Rear corner	AJ1	210055						
				210774						
			AJ2	210975						
				210774						
15	Adapter leg	Center	AJ1	223731						
				210772						
			AJ2	210977						
				211471						
16	Panel	Front	AJ1	210063			210064			
			AJ2	210984			210985			
17		Right side	AJ1	210613						
17A	Liner	Right side corner	AJ1	210777						
18	Panel	Left side (not shown)	AJ2	210988						
18A	Liner	Left side corner (not shown)	AJ2	211474						
19	Discharge top	Not shown	AJ1, AJ2	210631			210632			
20	Liner	Electrical top (not shown)	AJ1	221731			221732			
			AJ2	254108			254109			
21	Field supply power post assembly	208V/1PH/60Hz (option AK2)	AJ1	254198						
			AJ2	235080						
		230V/1PH/60Hz (option AK3)	AJ1	254198						
			AJ2	235080						
		208V/3PH/60Hz (option AK5)	AJ1	254199	254198	254198		254199	254198	
			AJ2	235079	254198	235080		235709	235080	
		230V/1PH/60Hz (option AK6)	AJ1	254199	254198			254199	254198	
			AJ2	235079	254198			235080	235080	
460V/3PH/60Hz (option AK7)	AJ1	221734	254199	254198	254198	221734	254199	254198		
	AJ2	205906	254119	235080	235080	254119	235079	235080		
575V/3PH/60Hz (option AK8)	AJ1	221734	254199	254199	254199	221734	254199	254198		
	AJ2	205906	254119	235079	235080	254119	235079	235080		

*AJ1 = left side controls (when facing system discharge) and AJ2 = right side controls.

CABINET COMPONENTS—CONTINUED

Base unit (electric heat section and blower) with left side controls (AJ1) shown

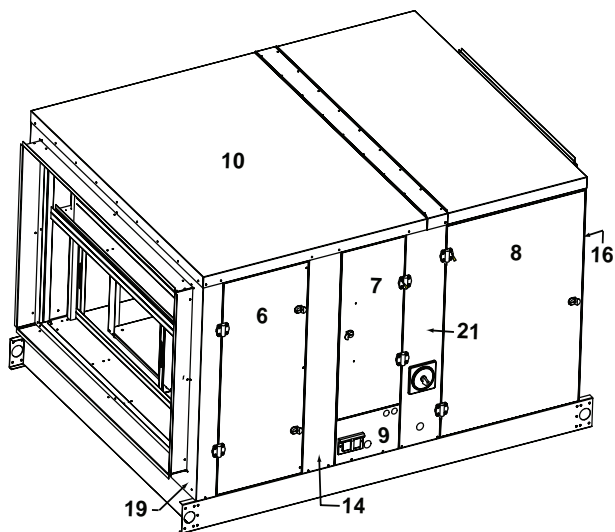


Figure 44. Cabinet Components—Outdoor Model REH (Refer to Table 65 and Table 66)

Table 65. Cabinet Components (Outdoor Model REH, Unit Sizes 10A–60B)

Item No.	Component	Description	Model REH Control Side*	Unit Size					
				10A	20A	40A	15B	30B	60B
				PN (Quantity)**					
1	Filter track	Assembly, top (not shown)	AJ1, AJ2	210873			210874		
2		Bottom (not shown)		210084			210085		
3	Filter rack	Assembly (not shown)		Not used on unit sizes 10A–60B					
4	Angle	Filter rack (not shown)		210080			210081		
5	Filter stop	Assembly (not shown)		—			212200		
6	Blower door assembly	AY3 insulation		214178					
		AY3H insulation		214180					
7	Door assembly	Electrical		214182					
8		Heat section		254041					
9	Power panel	Auxiliary	223644						
10	Liner	Top	AJ1	222554			222555		
			AJ2	214111			214112		
		Top, with mixing box or coil cabinet	AJ1	254060			254061		
			AJ2	215399			215400		
			AJ1	255177			255178		
			AJ2	214111			214112		
11	Top, heat section (not shown)	AJ1	255182			255183			
		AJ2	215399			215400			
12	Discharge side	Left (not shown)	AJ1	254133			254134		
			AJ2	215404			215405		
13	Discharge side	Right (not shown)	AJ1	215552			215552		
			AJ2	254053			254053		
14	Post/cover	Control, center (not shown)	AJ1	223590			223590		
				AJ2	254065			254065	
			AJ2	214143			214143		
				214145			214145		
15	Frame	End panel (not shown)	AJ1, AJ2	215431			215431		
				215433			215433		
15	Frame	End panel (not shown)	AJ1, AJ2	214161 (2)			214164 (2)		
				214162 (2)			214162 (2)		

*AJ1 = left side controls (when facing system discharge) and AJ2 = right side controls.

**Quantity is one (1) unless otherwise indicated.

Table 65. Cabinet Components (Outdoor Model REH, Unit Sizes 10A–60B)—Continued

Item No.	Component	Model REH		Unit Size					
		Description	Control Side*	10A	20A	40A	15B	30B	60B
				PN (Quantity)**					
16	Panel	Front	AJ1	214121			214122		
			AJ2	215409			215410		
Right side, solid outer (not shown)		AJ1	214138						
		AJ2	215426						
Blower, right side, inner (not shown)		AJ1	214131						
		AJ2	215419						
19		Inlet end, outer/inner	AJ1	214133			214134		
				214126			214127		
			AJ2	215421			215422		
	215414			215415					
20	Discharge top	Not shown	AJ1, AJ2	215554			215555		
21	Field supply power post assembly	208V/1PH/60Hz (option AK2)	AJ1	254045	254236	—	254197	254196	—
			AJ2	254067	255085		255085	254200	
		230V/1PH/60Hz (option AK3)	AJ1	254236	254234		254197	254196	
			AJ2	255085	254200		255085	254200	
		208V/3PH/60Hz (option AK5)	AJ1	—	254045	254236	—	254197	254196
			AJ2		254057	255085		255085	254200
		230V/1PH/60Hz (option AK6)	AJ1		254045	254234		254197	254196
			AJ2		254067	254200		255085	254200
		460V/3PH/60Hz (option AK7)	AJ1		254045	—		221735	254197
			AJ2		254067	—		254067	255085
		575V/3PH/60Hz (option AK8)	AJ1		254045	—		221735	254197
			AJ2		254067	—		254067	255085

*AJ1 = left side controls (when facing system discharge) and AJ2 = right side controls.

**Quantity is one (1) unless otherwise indicated.

Table 66. Cabinet Components (Outdoor Model REH, Unit Sizes 30D–120E)

Item No.	Component	Model REH		Unit Size						
		Description	Control Side*	30D	60D	90D	120D	40E	80E	120E
				PN (Quantity)**						
1	Filter track	Assembly, top	AJ1, AJ2	Not used on unit sizes 30D–120E						
2		Bottom (not shown)								
3	Filter rack	Assembly (not shown)								210871
4	Angle	Filter rack (not shown)		210082			210083			
5	Filter stop	Assembly (not shown)		212201						
6	Blower door assembly	AY3 insulation		214179						
		AY3H insulation		214181						
7	Door assembly	Electrical		214183						
8		Heat section		254044						
9	Power panel	Auxiliary	223644							
10	Liner	Top	AJ1	222556			222603 (two-piece)			
				214114			214115			
			AJ2	254062			254063 (two-piece)			
		Top, with mixing box or coil cabinet	AJ1	215402			215403			
				255179			255181 (two-piece)			
			AJ2	214114			214115			
11	Top, heat section (not shown)	AJ1	255184			255185 (two-piece)				
		AJ2	215402			215403				

*AJ1 = left side controls (when facing system discharge) and AJ2 = right side controls.

**Quantity is one (1) unless otherwise indicated.

CABINET COMPONENTS—CONTINUED

Table 66. Cabinet Components (Outdoor Model REH, Unit Sizes 30D–120E)—Continued										
Item No.	Component	Model REH		Unit Size						
				30D	60D	90D	120D	40E	80E	120E
		Description	Control Side*	PN (Quantity)**						
12	Discharge side	Left (not shown)	AJ1	215553			215553			
			AJ2	254054						
13	Discharge side	Right (not shown)	AJ1	210619			210619			
			AJ2	254066						
14	Post/cover	Control, center (not shown)	AJ1	214144			214146			
				AJ2	215432			215434		
			AJ1, AJ2		214165 (2)			214163 (2)		
				214166 (2)			214162 (2)			
16	Panel	Front (not shown)	AJ1	214124			214125			
17		Right side, solid outer (not shown)	AJ2	215412			215413			
			AJ1	214140			214137			
18		Blower, right side, inner (not shown)	AJ2	215428			214130			
	AJ1		214132			215425				
19	Inlet end, outer/inner	AJ1	215420			215417				
			AJ2	214136			215418			
		214129			215424			215418		
		215417			215425			215418		
20	Discharge top	Not shown	AJ1, AJ2	215557			215558			
21	Field supply power post assembly	208V/1PH/60Hz (option AK2)	AJ1	254233	—					
			AJ2	—						
		230V/1PH/60Hz (option AK3)	AJ1	254233	—					
			AJ2	—						
		208V/3PH/60Hz (option AK5)	AJ1	254235	254233	—	254235	254233	—	
			AJ2	235082	254198	235081	235082	235081	—	
		230V/1PH/60Hz (option AK6)	AJ1	254235	254233	—	254233	—	—	
			AJ2	235082	254198	235081				
460V/3PH/60Hz (option AK7)	AJ1	254046	254235	254233	254046	254235	254233			
	AJ2	254068	254119	235080	254068	235082	235081			
575V/3PH/60Hz (option AK8)	AJ1	254046	254235	254233	254046	254235	254233			
	AJ2	254068	254119	235079	235080	254068	235082	235081		

*AJ1 = left side controls (when facing system discharge) and AJ2 = right side controls.
 **Quantity is one (1) unless otherwise indicated.

Base unit (high-efficiency heat section and blower) with left side controls (AJ1) shown

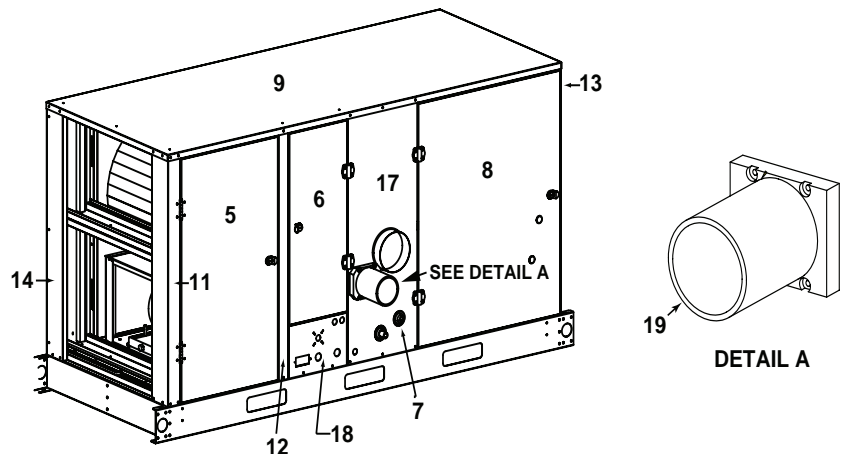


Figure 45. Cabinet Components—Indoor Model SHH (Refer to Table 67)

NOTE: The condensate drain kit (PN 273811) for all SHH models is shipped separately.

Table 67. Cabinet Components (Indoor Model SHH)

Item No.	Component	Model SHH	Unit Size			
			130, 180	260	350	
			PN (Quantity)**			
1	Filter rack***	Assembly	210870	210871	210872	
2	Angle***	Filter rack	210080	210082	210083	
3	Filter stop***	Assembly	—	212201		
4	Filter rack***	Side	210732			
5	Blower door assembly	AY2 insulation	210846			
		AY3 insulation	210848			
		AY3H insulation	213362			
6	Electrical door	Assembly	212243			
7	Grommet		105607 (2)	15021		
				105607		
8	Door assembly	Gas control	AJ1	254861		
			AJ2	257959		
9	Top		AJ1	254866	254790	254791
						254792
			AJ2	257623	257624	257626
						257625
10	Liner	Top, with insulation	AJ1	210780	210781	210782
			AJ2	211477	211478	211479
11	Corner	Rear	AJ1	210055		
			AJ2	210975		
12	Post	Center	AJ1	210057		
			AJ2	210977		
13	Panel	Front	AJ1	210062	210063	210064
			AJ2	210983	210984	210985
14	Panel and corner	Right side	AJ1	254868	254799	
		Left side	AJ2	257618	257619	
15	Discharge top		AJ1	210630	210631	210632
			AJ2	211248	211249	211250
16	Liner	Heat exchanger, top (not shown)	AJ1	254867	254793	254794
			AJ2	257627	257628	257629
17	Post assembly	Field connection, with inlet collar	AJ1	254865		
			AJ2	257960		
18	Connection panel	Field power	AJ1	210769		
			AJ2	211469		
18A	Plate	Cover	209001			
19	Venter Block	Assembly	221518			

*AJ1 = left side controls (when facing system discharge) and AJ2 = right side controls.
**Quantity is one (1) unless otherwise indicated.
***With filters (AW2-21). If unit is equipped with cooling coil cabinet, filter rack and filters are in cooling coil cabinet.

CABINET COMPONENTS—CONTINUED

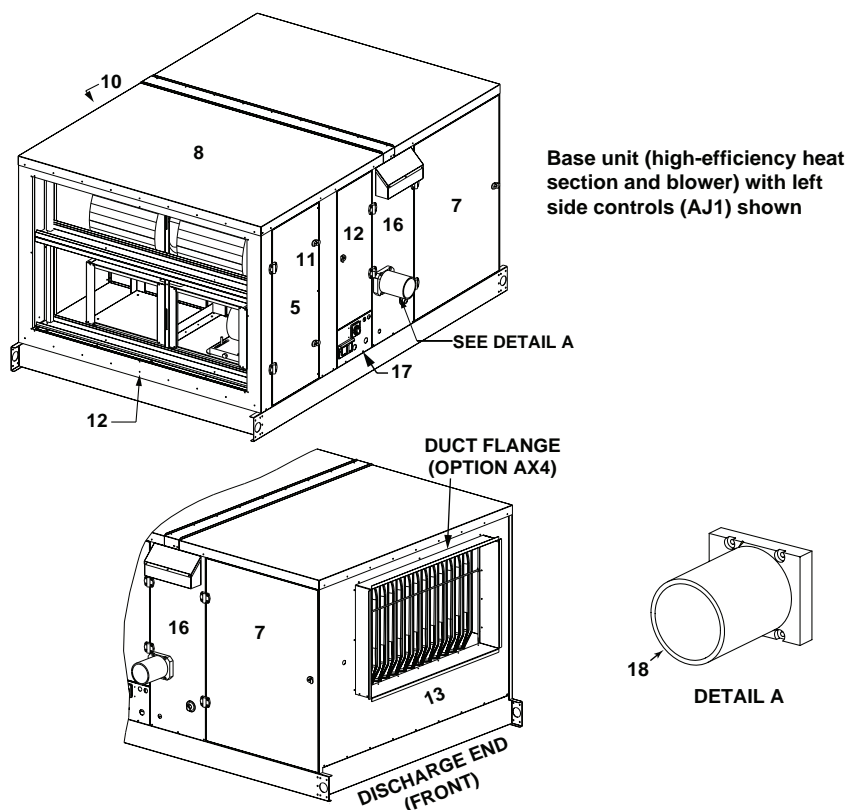


Figure 46. Cabinet Components—Outdoor Model RHH (Refer to Table 68)

NOTE: The condensate drain kit (PN 273811) for all RHH models is shipped separately.

Table 68. Cabinet Components (Indoor Model RHH)

Item No.	Component	Model RHH		Unit Size		
		Description	Control Side*	130, 180	260	350
				PN (Quantity)**		
1	Filter rack***	Assembly	AJ1, AJ2	210870	210871	210872
2	Angle***	Filter rack		210080	210082	210083
3	Filter stop***	Assembly		—	212201	
4	Filter rack***	Side		210732		
5	Blower door assembly	AY3 insulation		214179		
		AY3H insulation		214181		
6	Electrical door	Assembly	214183			
7	Door assembly	Gas control	AJ1	262093		
			AJ2	262093		
8	Top	Heat section and blower base unit	AJ1	261681	262055	262095 214168
			AJ2	262089	262090	262091 215442
		Splice	AJ1	214185		
			AJ2	214171		
9	Liner	Top, with insulation	AJ1	261682	262072	262073
			AJ2	262079	262080	262081
10	Wall	Solid	AJ1	261684	262071	
			AJ2	262085	262086	

*AJ1 = left side controls (when facing system discharge) and AJ2 = right side controls.
 **Quantity is one (1) unless otherwise indicated.
 ***With filters (AW2-21). If unit is equipped with cooling coil cabinet, filter rack and filters are in cooling coil cabinet.

Table 68. Cabinet Components (Indoor Model RHH)—Continued						
Item No.	Component	Model RHH		Unit Size		
				130, 180	260	350
		Description	Control Side*	PN (Quantity)**		
11	Post	Control Side	AJ1	214146		
			AJ2	215434		
12	Panel	Inlet end	AJ1	214135	214136	214137
			AJ2	215423	215424	215425
13	Panel	Front (discharge)	AJ1	214123	214124	214125
			AJ2	215411	215412	215413
14	Discharge top		AJ1	215556	215557	215558
			AJ2	215556	215557	215558
15	Liner	Heat exchanger, top (not shown)	AJ1	261683	262074	262075
			AJ2	262082	262083	262084
16	Post assembly	Field connection, with combustion air hood	AJ1	260744		
			AJ2	263319		
17	Connection panel	Field power	AJ1	214151 (Cover Plate 209001)		
			AJ2	215439 (Cover Plate 209001)		
17A	Plate	Cover	AJ1, AJ2	209001		
18	Venter Block	Assembly	AJ1, AJ2	221518		

*AJ1 = left side controls (when facing system discharge) and AJ2 = right side controls.
**Quantity is one (1) unless otherwise indicated.
***With filters (AW2-21). If unit is equipped with cooling coil cabinet, filter rack and filters are in cooling coil cabinet.

OPTIONAL EVAPORATIVE COOLING MODULE COMPONENTS

NOTE:

- The optional evaporative cooling module (option ECC2 or ECC3, see [Figure 47](#)) is factory-installed at the unit's inlet air opening.
- The module's cooling media and optional pre-filters are listed in [Table 69](#) and [Table 70](#).
- The module's factory-installed cabinet components (see [Figure 48](#)) are listed in [Table 71](#).
- The module's water piping components (see [Figure 49](#)) are listed in [Table 72](#).
- The module's controls (see [Figure 50](#)) are listed in [Table 73](#).
- The module's optional fill and drain and freeze-protection controls (see [Figure 51](#)) are listed in [Table 74](#).
- If a required part is not listed, contact your Distributor or Factory Representative.



Figure 47. Option ECC2 or ECC3: Evaporative Cooling Module

OPTIONAL EVAPORATIVE COOLING MODULE COMPONENTS—CONTINUED

Table 69. Evaporative Cooling Module Cooling Media Pads					
Outdoor Model			Size (Inches)	Glacier-Cor*	Glasdek*
RDH	REH	RXH		PN (Quantity)**	
Unit Size					
75, 100	10A, 20A, 40A	000A	29-1/4 x 12 x 6	216812 (2)	216814 (2)
			29-1/4 x 12 x 12	216813 (2)	216815 (2)
			29-1/4 x 7-1/2 x 6	216816	216819
			29-1/4 x 7-1/2 x 12	216817	216820
125, 150	15B, 30B, 60B	000B	29-1/4 x 12 x 6	216812 (3)	216814 (3)
			29-1/4 x 12 x 12	216813 (3)	216815 (3)
			29-1/4 x 5-1/2 x 6	216821	219823
			29-1/4 x 5-1/2 x 12	216822	216824
175, 200, 225	—	000C	36 x 12 x 6	216549 (2)	216551 (2)
			36 x 12 x 12	216550 (2)	216552 (2)
			36 x 7-1/2 x 6	216825	216827
			36 x 7-1/2 x 12	216826	216828
250, 300	30D, 60D, 90D, 120D	000D	36 x 12 x 6	216549 (3)	216551 (3)
			36 x 12 x 12	216550 (3)	216552 (3)
			36 x 11-3/4 x 6	216829	216831
			36 x 11-3/4 x 12	216830	216832
350, 400A	40E, 80E, 120E	000E	36 x 12 x 6	216549 (4)	216551 (4)
			36 x 12 x 12	216550 (4)	216552 (4)
			36 x 7-3/4 x 6	216833	216835
			36 x 7-3/4 x 12	216834	216818
Indoor Model			Size (Inches)	Glacier-Cor*	Glasdek*
PDH, SDH	PEH	PXH		PN (Quantity)**	
Unit Size					
75, 100	10A, 20A, 40A	000A	27-3/32 x 12 x 6	220384 (2)	220386 (2)
			27-3/32 x 12 x 12	220385 (2)	220387 (2)
			27-3/32 x 7-1/2 x 6	220388	220390
			27-3/32 x 7-1/2 x 12	220389	220391
125, 150	15B, 30B, 60B	000B	27-3/32 x 12 x 6	220384 (3)	220386 (3)
			27-3/32 x 12 x 12	220385 (3)	220387 (3)
			27-3/32 x 5-1/2 x 6	220392	220394
			27-3/32 x 5-1/2 x 12	220393	220395
175, 200, 225	—	000C	36 x 12 x 6	216549 (2)	216551 (2)
			36 x 12 x 12	216550 (2)	216552 (2)
			36 x 7-1/2 x 6	216825	216827
			36 x 7-1/2 x 12	216826	216828
250, 300	30D, 60D, 90D, 120D	000D	36 x 12 x 6	216549 (3)	216551 (3)
			36 x 12 x 12	216550 (3)	216552 (3)
			36 x 11-3/4 x 6	216829	216831
			36 x 11-3/4 x 12	216830	216832
350, 400A	40E, 80E, 120E	000E	36 x 12 x 6	216549 (4)	216551 (4)
			36 x 12 x 12	216550 (4)	216552 (4)
			36 x 7-3/4 x 6	216833	216835
			36 x 7-3/4 x 12	216834	216818

*Glacier-Cor® and Glasdek® are trademarks of Munters Corporation.

**Quantity is one (1) unless otherwise indicated.

Table 70. Evaporative Cooling Module Optional Pre-Filters*					
Model			Row	Size (Inches)	PN (Quantity)**
PDH, SDH, RDH	PEH, REH	PXH, RXH			
Unit Size					
75, 100	10A, 20A, 40A	000A	Top	16 x 12 x 1	114334 (2)
				16 x 12 x 2	114325 (2)
			Bottom	16 x 16 x 1	104102 (2)
				16 x 16 x 2	104103 (2)
125, 150	15B, 30B, 60B	000B	Top	16 x 12 x 1	114334
				16 x 12 x 2	114325
			Bottom	16 x 16 x 1	104102
				16 x 16 x 2	104103
			Top	25 x 12 x 1	114333
				25 x 12 x 2	114322
			Bottom	16 x 25 x 1	101609
				16 x 25 x 2	101622
175, 200, 225	—	000C	Top	16 x 12 x 1	114334 (2)
				16 x 12 x 2	114325 (2)
			Bottom	16 x 16 x 1	104102 (2)
				16 x 16 x 2	104103 (2)
250, 300	30D, 60D, 90D, 120D	000D	Top	16 x 12 x 1	114334 (3)
				16 x 12 x 2	114325 (3)
			Bottom	16 x 25 x 1	101609 (3)
				16 x 25 x 2	101622 (3)
350, 400A	40E, 80E, 120E	000E	Top	16 x 12 x 1	114334
				16 x 12 x 2	114325
			Bottom	16 x 25 x 1	101609
				16 x 25 x 2	101622
			Top	20 x 12 x 1	114332 (2)
				20 x 12 x 2	114321 (2)
			Bottom	20 x 25 x 1	101610 (2)
				20 x 25 x 2	101623 (2)

*Aluminum filters (option PF4 or PF5).
**Quantity is one (1) unless otherwise indicated.

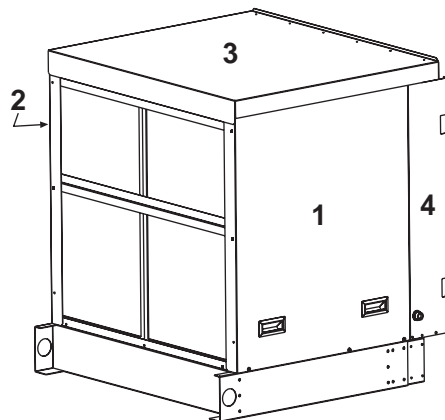


Figure 48. Evaporative Cooling Module Cabinet Components (Refer to Table 71)

OPTIONAL EVAPORATIVE COOLING MODULE COMPONENTS—CONTINUED

Table 71. Evaporative Cooling Module Factory-Installed Cabinet Components									
Item No.	Component	Models PDH, RDH, and SDH			Unit Size				
					75, 100	125, 150	175, 200, 225	250, 300	350, 400A
		Models PEH and REH			10A, 20A, 40A	15B, 30B, 60B	—	30D, 60D, 90D, 120D	40E, 80E, 120E
		Models PXH and RXH			000A	000B	000C	000D	000E
		Description	Type of Steel	Contol Side*	PN (Quantity)**				
1	Door	Removable panel on control side	Pre-painted	AJ1	216211		216212		
			Stainless		216988		216989		
			Pre-painted	AJ2	216877		216878		
			Stainless		217029		217030		
2	Non-control side panel	Not an access panel	Pre-painted	AJ1	216200		216201		
			Stainless		216899		216900		
			Pre-painted	AJ2	216365		216366		
			Stainless		216921		216922		
3	Top		Pre-painted	AJ1	216172	216173	216172	216174	216175
			Stainless		216879	216880	216879	216881	216882
			Pre-painted	AJ2	216223	216354	216223	216355	216356
			Stainless		216909	216910	216909	216911	216912
4	Post	Control side where water connection is located	Pre-painted	AJ1	216213		216214		
			Stainless		216906		216907		
			Pre-painted	AJ2	216357		216358		
			Stainless		216913		216914		
5	Media side plate	Vertical, on non-access side inside cabinet (not shown)	Aluminized	AJ1	216198		216199		
			Stainless		216897		216898		
			Aluminized	AJ2	216359		216360		
			Stainless		216915		216916		
6	Media bottom support	Front, adjustable for 6- or 12-inch media (not shown)	Stainless	AJ1, AJ2	216168	216169	216168	216170	216171
7		Rear, non adjustable (not shown)			216164	216165	216164	216166	216167
8	Cooler drain	Assembly (not shown)	—		257554 (2)				
8A	Bushing (not shown)				256911 (2)				
8B	Nut (not shown)				256912 (2)				
8C	Gasket (not shown)				257460 (2)				

*AJ1 = left side controls (when facing system discharge) and AJ2 = right side controls.

**Quantity is one (1) unless otherwise indicated.

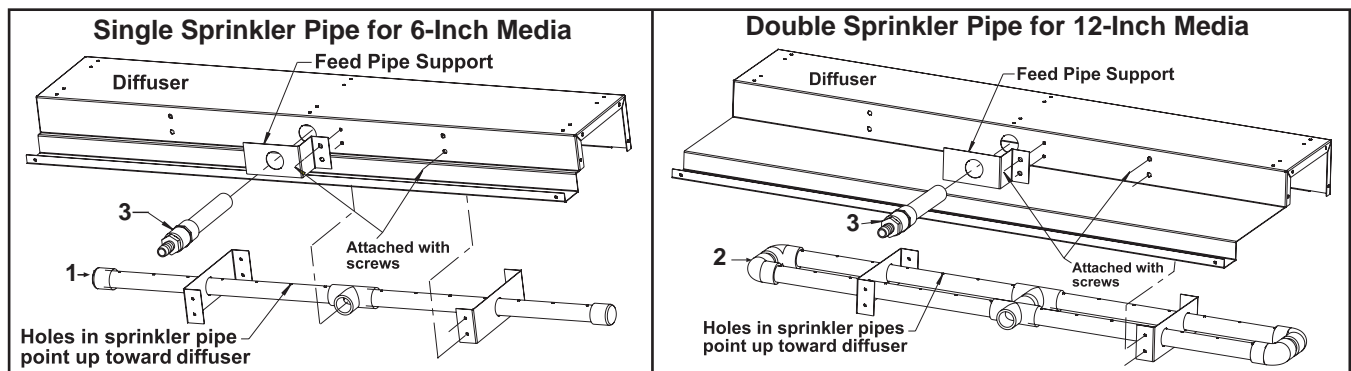


Figure 49. Evaporative Cooling Module Water Piping Components (Refer to Table 72)

Table 72. Evaporative Cooling Module Water Piping Components

Item No.	Models PDH, RDH, and SDH		Unit Size				
			75, 100	125, 150	175, 200, 225	250, 300	350, 400A
	Models PEH and REH		10A, 20A, 40A	15B, 30B, 60B	—	30D, 60D, 90D, 120D	40E, 80E, 120E
	Models PXH and RXH		000A	000B	000C	000D	000E
Component		Description	PN				
1	Sprinkler assembly	Single pipe, 6-inch media	216850	216851	216850	216852	216853
2		Double pipe, 12-inch media	216846	216847	216846	216848	216849
3	Feed line	Assembly	216854				
4	Screen	Intake (not shown)	217219	217220	217221	217222	217223

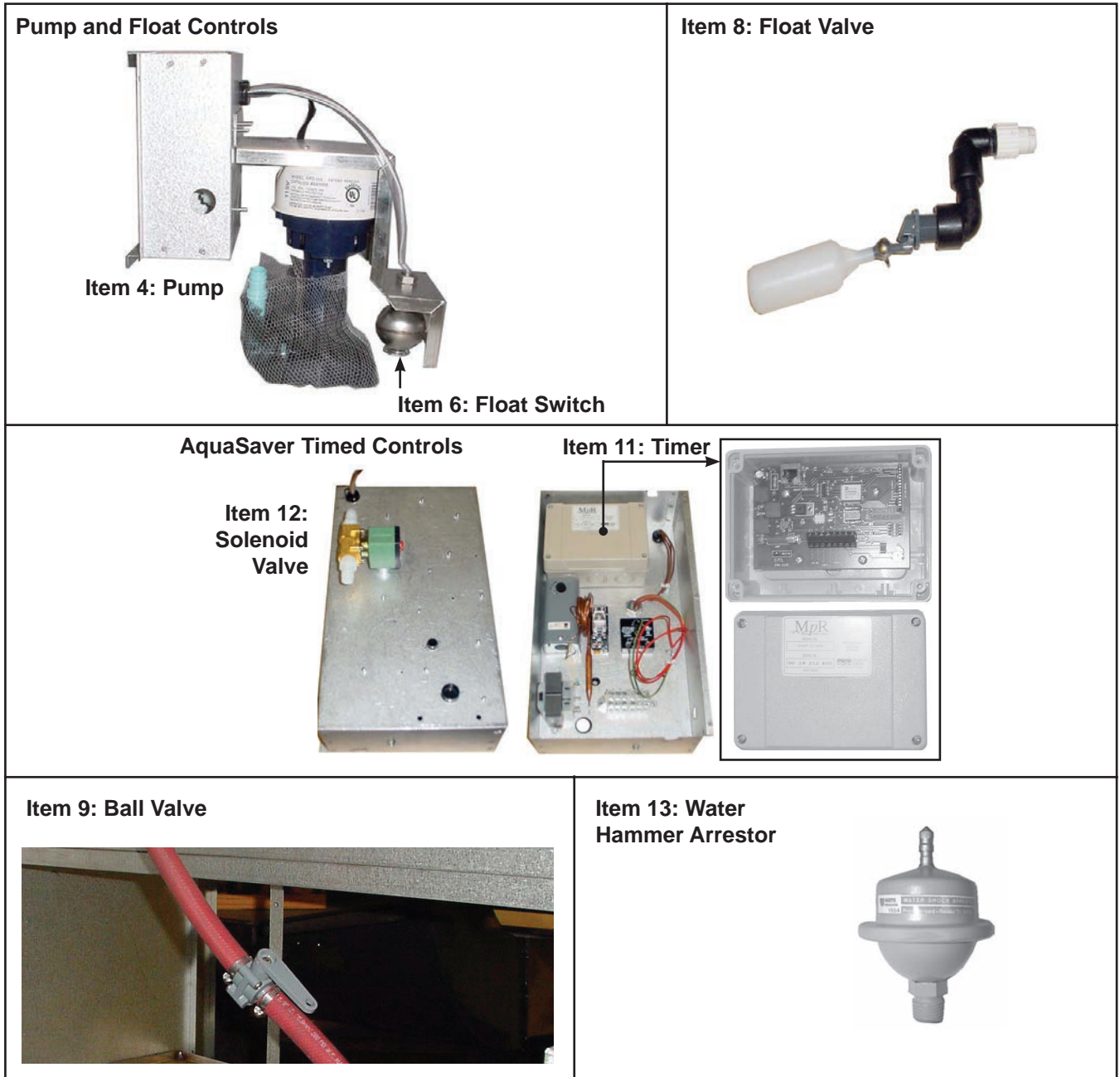


Figure 50. Evaporative Cooling Module Controls (Refer to Table 73)

NOTE: The ball valve (item 9) is used to regulate water flow with both the pump and float and the AquaSaver controls.

OPTIONAL EVAPORATIVE COOLING MODULE COMPONENTS—CONTINUED

Table 73. Evaporative Cooling Module Controls				
Item No.	Component	Models PDH, RDH, and SDH		Unit Size
		Models PEH and REH		75, 100, 125, 150, 175, 200, 225, 250, 300, 350, 400A
		Models PXH and RXH		10A, 20A, 40A, 15B, 30B, 60B, 30D, 60D, 90D, 120D, 40E, 80E, 120E
		Description	Unit/Option Applicability	PN
1	Control junction box for pump/float and AquaSaver controls (not shown)	Aluminized steel	Units with left side controls	216215
		Stainless steel		216908
		Aluminized steel	Units with right side controls	216624
		Stainless steel		216928
2	Terminal block (not shown)	Units with pump/float and AquaSaver controls		144972
3	Transformer (not shown)	208/240V, 50/60Hz		194536
4	Pump, with mesh screen over inlet	115V, 460V, 575V		107186
		208V, 230V		107197
5	Support (not shown)	Pump		133486
6	Float switch	Madison 5600-PR		201446
7	Tubing (not shown)	1/4-inch bleed line hose		Replace with field-supplied tubing
8	Float valve	Kerick MA-052		216553
9	Ball valve	5/8 x 5/8-inch barb		207468
10	Rubber hose, 200 psi (not shown)*	22 long x 5/8 ID x 1 OD (inches)		207463
		8 long x 5/8 ID x 1 OD (inches)		207464
		15 long x 5/8 ID x 1 OD (inches)		207465
		28 long x 5/8 ID x 1 OD (inches)		207504
		36 long x 5/8 ID x 1 OD (inches)		207505
11	Timer	Microprocessor, assembly		205044
12	Solenoid valve	1/2-inch (AA577)		205045
13	Water hammer arrestor	Option ECB1		166464

*Order by length needed.

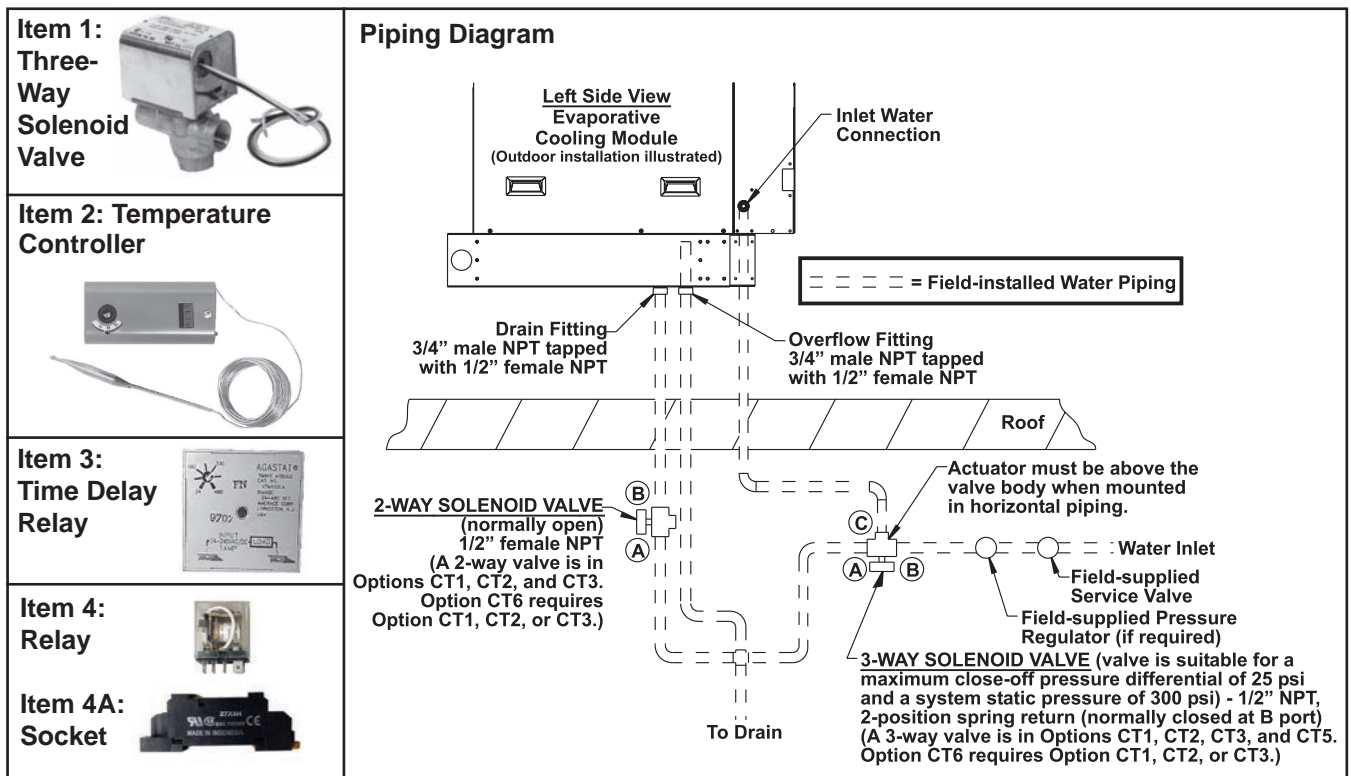


Figure 51. Evaporative Cooling Module Optional Fill and Drain Kit and Freeze-Protection Components (Refer to Table 74)

Table 74. Evaporative Cooling Module Optional Fill and Drain Kit and Freeze-Protection Components and Sequence of Operation

Item No.	Component	Description	Option	PN
1	Solenoid valve, field-installed	Two-way, 115V	CT1	50032
		Two-way, 208V	CT2	50297
		Two-way, 230V	CT3	50299
		Three-way, 115V	CT1	50033
		Three-way, 208V	CT2	50296
		Three-way, 230V	CT3	50298
		Three-way, 24V	CT5	178677
2	Temperature controller		CT5, CT6	126170
3	Time delay relay	Factory-installed in AquaSaver junction box	CT5	89661
4	Relay		CT5	211411
4A	Relay socket		CT5	211415
Unit Applicability		Option	Sequence of Operation	
Units with optional fill and drain and/or freeze protection kits (float and pump system with optional fill and drain kit)		CT1, CT2, or CT3	1) Call for cooling	
			2) Two-way solenoid valve is energized, closing B to A	
			3) Three-way solenoid valve is energized, opening B to C and closing A to C	
			4) During no call for cooling, valves return to normal state	
Units with AquaSaver timed water system with optional freeze protection		CT5	1) Call for cooling	
			2) Three-way solenoid valve is energized, opening B to C and closing A to C	
			3) If outside air temperature drops below freeze protection controller setting, three-way solenoid valve is de-energized and AquaSaver 24V solenoid valve remains energized for 8 minutes to allow complete system water drainage	
			4) During no call for cooling, three-way solenoid valve returns to normal state	
Units with float and pump system with optional fill and drain kit with freeze protection		CT1, CT2, or CT3 with option CT6	1) Call for cooling	
			2) Two-way solenoid valve is energized, closing B to A	
			3) Three-way solenoid valve is energized, opening B to C and closing A to C	
			4) If outside air temperature drops below freeze protection controller setting, valves return to normal state	
			5) During no call for cooling, valves return to normal state	

NOTES

NOTES



**R-410A
Refrigerant**



Intertek

Specifications and illustrations subject to change without notice or incurring obligations.
Latest version of this manual is available at www.reznorhvac.com.
©2022 Nortek Global HVAC LLC, O'Fallon, MO. All rights reserved.
P-PREEVA (02-22) 263985-C

