

**Service Manual for the Lang Models:  
RF21S-A, RF21S-C, RF21S-D, RF21S-G, RF21S-H**

# TABLE OF CONTENTS

<u>CHAPTER</u>	<u>PAGE</u>
1. TABLE OF CONTENTS .....	1
2. READ FIRST .....	2
3. EQUIPMENT DESCRIPTION .....	4
4. INSTALLATION.....	5
5. START-UP .....	6
6. GENERAL OPERATION.....	7
7. SEQUENCE OF OPERATION .....	9
8. TROUBLESHOOTING .....	10
9. TECHNICAL DATA .....	12
10. WIRING DIAGRAMS.....	15
11. PARTS LIST.....	18

**CAUTION:** EACH UNIT WEIGHS 600 LBS (THE TOP ONLY WEIGHS 410 LBS). FOR SAFE HANDLING, INSTALLER SHOULD OBTAIN HELP AS NEEDED, OR EMPLOY APPROPRIATE MATERIALS HANDLING EQUIPMENT (SUCH AS A FORKLIFT, DOLLY, OR PALLET JACK) TO REMOVE THE UNIT FROM THE SKID AND MOVE IT TO THE PLACE OF INSTALLATION.



**CAUTION:** ANY STAND, COUNTER OR OTHER DEVICE ON WHICH RANGE WILL BE LOCATED MUST BE DESIGNED TO SUPPORT THE WEIGHT OF THE RANGE.



**CAUTION:** SHIPPING STRAPS ARE UNDER TENSION AND CAN SNAP BACK WHEN CUT.



**DANGER:** THIS APPLIANCE MUST BE GROUNDED AT THE TERMINAL PROVIDED. FAILURE TO GROUND THE APPLIANCE COULD RESULT IN ELECTROCUTION AND DEATH.



**WARNING:** INSTALLATION OF THE UNIT MUST BE DONE BY PERSONNEL QUALIFIED TO WORK WITH ELECTRICITY. IMPROPER INSTALLATION CAN CAUSE INJURY TO PERSONNEL AND/OR DAMAGE TO EQUIPMENT. UNIT MUST BE INSTALLED IN ACCORDANCE WITH ALL APPLICABLE CODES.



**NOTICE:** The data plate is located right of range top controls and behind circuit breaker door on oven. The range voltage, wattage, serial number, wire size, and clearance specifications are on the data plate. This information should be carefully read and understood before proceeding with the installation.



**NOTICE:** The installation of any components such as a vent hood, grease extractors, fire extinguisher systems, must conform to their applicable National, State and locally recognized installation standards.



**NOTICE:** During the first few hours of operation you may notice a small amount of smoke coming off the range, or out of the oven, and a faint odor from the smoke. This is normal for a new range and will disappear after the first few hours of use.



**CAUTION:** ALWAYS KEEP THE AREA NEAR THE APPLIANCE FREE FROM COMBUSTIBLE MATERIALS.



**CAUTION:** KEEP FLOOR IN FRONT OF EQUIPMENT CLEAN AND DRY. IF SPILLS OCCUR, CLEAN IMMEDIATELY, TO AVOID THE DANGER OF SLIPS OR FALLS.



**WARNING:** KEEP WATER AND SOLUTIONS OUT OF CONTROLS. NEVER SPRAY OR HOSE CONTROL CONSOLE, ELECTRICAL CONNECTIONS, ETC.



**CAUTION:** MOST CLEANERS ARE HARMFUL TO THE SKIN, EYES, MUCOUS MEMBRANES AND CLOTHING. PRECAUTIONS SHOULD BE TAKEN TO WEAR RUBBER GLOVES, GOGGLES OR FACE SHIELD AND PROTECTIVE CLOTHING. CAREFULLY READ THE WARNING AND FOLLOW THE DIRECTIONS ON THE LABEL OF THE CLEANER TO BE USED.



**NOTICE:** Service on this, or any other, LANG appliance must be performed by qualified personnel only. Consult your authorized service station directory or call the factory at 1-800-224-LANG (5264), or [WWW.LANGWORLD.COM](http://WWW.LANGWORLD.COM) for the service station nearest you.



**WARNING:** BOTH HIGH AND LOW VOLTAGES ARE PRESENT INSIDE THIS APPLIANCE WHEN THE UNIT IS PLUGGED/WIRED INTO A LIVE RECEPTACLE. BEFORE REPLACING ANY PARTS, DISCONNECT THE UNIT FROM THE ELECTRIC POWER SUPPLY.



**CAUTION:** USE OF ANY REPLACEMENT PARTS OTHER THAN THOSE SUPPLIED BY LANG OR THEIR AUTHORIZED DISTRIBUTORS CAN CAUSE BODILY INJURY TO THE OPERATOR AND DAMAGE TO THE EQUIPMENT AND WILL VOID ALL WARRANTIES.



# EQUIPMENT DESCRIPTION

## ELECTRIC RANGE

### EXTERIOR

- The Range dimensions are 30" (76.2cm) High, 38" (96.5cm) Deep, and 36" (91.5cm) Wide.
- The Sides, Bottom, and Rear wall are constructed stainless steel.
- The Range surface can come in 5 different configurations.

### RANGE TOP CONTROLS

The RF21 Series Rang is available with various controls depending upon model number. Shown below is a layout of each top configuration with its proper model number and a brief description of the controls. All RF21S Ranges have the same type of convection oven, which has a thermostat that controls the overall temperature of the oven.

#### **RF21S-H**

Six French plates controlled by six 6-heat switches.

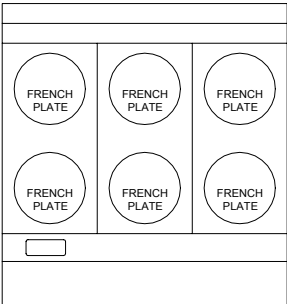

#### **RF21S-C**

Three Hot Tops controlled by three 850° thermostats.

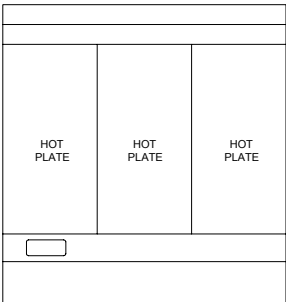

#### **RF21S-G**

One 36"x24" Griddle controlled by one 450° thermostat.

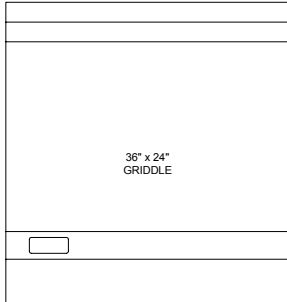

#### **RF21S-A**

One 24"x24" griddle controlled by Two 450° thermostats and Two French plates controlled by two 6-heat switches.

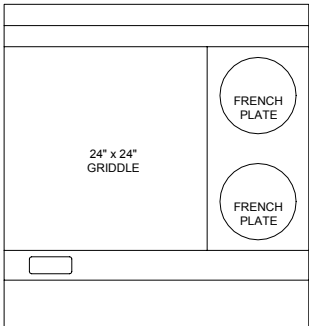

#### **RF21S-D**

Two 12"x24" Hot tops controlled by two 850° thermostats and two French plates controlled by two 6-heat switches.

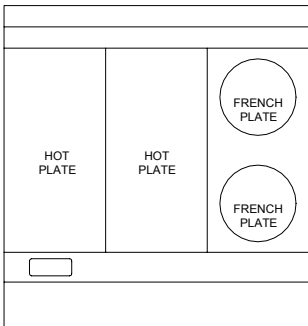

**RECEIVING THE RANGE**

Upon receipt, check for freight damage, both visible and concealed. Visible damage should be noted on the freight bill at the time of delivery and signed by the carrier's agent. Concealed loss or damage means loss or damage, which does not become apparent until the merchandise has been unpacked.

If concealed loss or damage is discovered upon unpacking, make a written request for inspection by the carrier's agent within 15 days of delivery. All packing material should be kept for inspection.

Do not return damaged merchandise to Lang Manufacturing Company. File your claim with the carrier.

Prior to un-crating, move the range as near its intended location as practical. The crating will help protect the unit from the physical damage normally associated with moving it through hallways and doorways.

**ELECTRICAL CONNECTION**

Place spacers, (ie. 2 x 4 wood block not supplied) at the front and rear of the oven top.

Place the range top on the spacers that are located on top of the oven.

The six wire leads to supply electricity to the cook top are bundled under the front bottom of the top. Route these wires through the bushing provided in the oven top.

Align the four locating pins in the bottom corner of the top with the four holes in each corner of the oven top.

Remove the spacers and lower the top onto the oven.

**CAUTION:** MAKE SURE THE SIX WIRE LEADS TO SUPPLY ELECTRICITY TO THE COOK TOP ARE NOT CRIMPED BETWEEN THE OVEN AND RANGE TOP.

**WARNING:** MAKE SURE THE MAIN POWER SUPPLY TO THE RANGE IS TURNED OFF AT THE SOURCE PRIOR TO CONNECTING POWER TO THE RANGE.

The range can now be connected to power.

**CAUTION:** BE SURE THE POWER SUPPLY VOLTAGE MATCHES THE VOLTAGE SPECIFIED ON THE NAMEPLATE LOCATED ON THE FRONT OF THE RANGE.

Use the wiring diagram provided in this manual for determining the connections of the cook top wires to the oven terminal block.

Electrical service connection is made through the bottom of the oven. A hole is provided for the attachment of 1-1/4 inch conduit. See figure #2 on Page #2.

Use the wiring diagram provided in this manual to determine the electrical specification.

**CAUTION:** THE RANGE MUST BE PHASED PER THE WIRING DIAGRAM.

**PHASING**

POWER SUPPLY	TERMINAL BLOCK	RANGE TOP
SINGLE PHASE	L1	1,3,5
	L2	2,4,6
THREE PHASE	L1	3
	L2	1,5
	L3	2,4,6



## **RANGE**

The range is designed to give, well regulated, uniform heat throughout the oven and over the surface units. The oven and surface units should be thoroughly preheated before being used. It is advantageous from an operating cost stand point to operate with the switches and/or thermostats set at the lowest position that will satisfactorily perform the cooking being done.

## **OVEN**

The convection oven roasts and bakes in shorter time and at lower temperatures with less shrinkage than conventional commercial ovens.

A blower in the Lang convection oven circulates air within the chamber to heat the entire space evenly and transfer heat efficiently to the product, even with stacked loading.

The airflow continuously removes the thick layer of moist, cool air that otherwise would surround the product. When properly loaded and operated, it maintains this airflow throughout the chamber to eliminate hot spots and roasts or bakes with minimum power consumption at twice the output capacity of a conventional oven.

The power switch on the lower portion of the control panel energizes the fan motor and activates the thermostatically controlled circuit for the oven heating elements. When this switch is in the on position, the white bar indicator marked "power" will be illuminated.

Rotating the thermostat control knob from "off" position to selected temperature causes the red bar indicator light to illuminate and closes the contactor that feeds power to the heating elements. This light will cycle "on and off" as the thermostat calls for heat in the oven. The blower, however, operates continuously while the power switch is in the "on" position.

The black control knob operates a damper in the oven vent stack. Damper is open when knob is pulled outward.

Circuit breakers behind the control panel protect the electrical components from overload.

## **INITIAL PREHEAT**

Prior to putting any range or oven into full time operation at normal cooking temperatures, it must be thoroughly "seasoned" or dried out. Moisture absorption in the closed spaces, in the insulation and even inside the heating elements can cause future trouble if not properly treated.

To "season" the convection oven, set the thermostat dial at 200°F and turn on the power switch. Allow unit to cycle at least 15 minutes at this heat level. Reset the thermostat to 250°F allowing the same time. Then reset the thermostat to 350°F. The oven should be operated at this heat level for a minimum of 4 hours preferably 5 hours, to insure the complete removal of all moisture.

If the unit is out of use for three or more days, a one hour preheat schedule should be used, especially when exposed to high humidity and/or cool temperatures.

## **RANGE TOP**

Consists of the various top arrangements, depending on specific model purchased:

12" x 24" hot plate controlled by high temperature thermostats. Temperature ranges from 0°-800°.

Recommended: Stock pots and heavy kettle work.

Round French Plates, controlled by indicating type 6-heat switch. Temperature ranges from 0°-750°.

Recommended: Light duty sauce pans and small stockpots. Not Recommended: Heavy stock pots, or heavy urns, or kettles.

36" x 24" or 24" x 24" grill plates, controlled by thermostats. Temperature ranges from 0°-450°.

Recommended: All heavy and light frying. Set the thermostat dial at the desired temperature. The red pilot light will be on until the desired temperature is reached. The pilot light indicates when the plate is heating.

## **CARE AND CLEANING**

The range should be thoroughly cleaned at least once a week in addition to the normal daily cleaning to insure against the accumulation of foreign material. Keep inside of oven and metal deck clean, particularly around door opening, door edges and at bottom of door opening so that the door may close tightly. CAUTION: ANY OVEN CLEANER USED SHOULD BE MARKED: "SAFE ON ALUMINUM".

Keep-drip pans under range top plates clean.

Keep hotplate and griddle surfaces clean.

Outside of range and top should be kept clean.

Electric equipment is inherently clean and sanitary, but may become unsanitary if dirt is allowed to accumulate on it. Take advantage of the clean, sanitary features of electric equipment, give it the regular attention that it deserves the same as any other highly perfected machinery, to insure best results and continued high operating efficiency.

## **CALIBRATION**

### **Calibration Check**

- Place thermometer or thermocouple in the center of oven cavity.
- Set thermostat to 350° and place both 3-heat switches in the "HIGH" position.
- Allow the oven to Preheat for at least half an hour.
- Note cycle on temperatures and cycle off temperatures for 3 cycles. (Red indicator light indicates when oven is calling for heat)
- After 3 cycles average the temperature. ( Add all six temperatures and divide by 6)

### **Calibration Adjustment**

- A 1/16" flat blade screwdriver with a 2" shaft is required to make adjustments on the thermostat.
- Maintain the oven temperature at 350°.
- Without turning the thermostat, remove the knob.
- Locate the adjustment screw at the base of the shaft and insert the screwdriver.
- Grasp the shaft and turn the screwdriver. Counter clockwise to increase and clockwise to decrease. (1/8 of a turn will move the temperature 5-7 ° in either direction.)
- Reinstall the oven knob and recheck the oven temperature.

# SEQUENCE OF OPERATION

## **OVEN**

**Power switch to “ON” position.**

208/ 240 VAC to Motor.

**Motor turns on.**

208/240 VAC to Thermostat.

**Thermostat turned on.**

208/ 240 VAC to contactor.

**Contactor energizes.**

208/ 240 VAC to elements.

## **HOT TOP**

208/ 240 VAC to thermostat.

**Thermostat turned on.**

208/ 240 VAC to elements.

## **FRENCH PLATE**

208/ 240 VAC to 6-heat switch.

**6-Heat switch turned on.**

208/240 VAC to French plates.

## **GRIDDLE**

208/ 240 VAC to Thermostat.

**Thermostat turned on.**

208/ 240 VAC to elements.

## OVEN

### OVEN WILL NOT HEAT

PROBABLE CAUSE	CORRECTIVE ACTION
Defective Fuses.	➤ Replace Fuse.
Incorrect wiring	<ul style="list-style-type: none"> <li>➤ Confirm that oven is getting proper voltage.</li> <li>➤ Confirm that range is phased correctly.</li> </ul>
Defective Thermostat	<ul style="list-style-type: none"> <li>➤ Confirm that thermostat is getting correct voltage.</li> <li>➤ Confirm that thermostat was operating properly.</li> </ul>
Defective Element	➤ Check element for normal operation. (See Technical Data)

### OVEN MOTOR WILL NOT COME ON

PROBABLE CAUSE	CORRECTIVE ACTION
Defective Fuses.	➤ Replace Fuse.
Incorrect wiring	<ul style="list-style-type: none"> <li>➤ Confirm that oven is getting proper voltage.</li> <li>➤ Confirm that range is phased correctly.</li> </ul>
Defective Motor	<ul style="list-style-type: none"> <li>➤ Confirm that motor is getting power and working properly.</li> <li>➤ Replace Motor.</li> </ul>

## HOT TOP

### HOT TOP WILL NOT HEAT

PROBABLE CAUSE	CORRECTIVE ACTION
Incorrect wiring	<ul style="list-style-type: none"> <li>➤ Confirm the hot top is wired correctly.</li> <li>➤ Confirm that range is phased correctly.</li> </ul>
Defective 3-Heat switch	<ul style="list-style-type: none"> <li>➤ Confirm that switch is wired correctly.</li> <li>➤ Confirm that switch is operating correctly.</li> </ul>
Defective Hot Top	<ul style="list-style-type: none"> <li>➤ Confirm that Hot Tops are getting correct voltage.</li> <li>➤ Confirm that Hot Tops are operating correctly. (See Technical Data)</li> </ul>

## FRENCH PLATE

### FRENCH PLATE WILL NOT HEAT

PROBABLE CAUSE	CORRECTIVE ACTION
<b>Incorrect wiring</b>	<ul style="list-style-type: none"> <li>➤ Confirm the French Plate is wired correctly.</li> <li>➤ Confirm that range is phased correctly.</li> </ul>
<b>Defective 6-Heat switch</b>	<ul style="list-style-type: none"> <li>➤ Confirm that switch is wired correctly.</li> <li>➤ Confirm that switch is operating correctly.</li> </ul>
<b>Defective French Plate</b>	<ul style="list-style-type: none"> <li>➤ Confirm that French Plate is getting correct voltage.</li> <li>➤ Confirm that French Plate is operating correctly. (See Technical Data)</li> </ul>

## GRIDDLE

### GRIDDLE IS NOT HEATING

PROBABLE CAUSE	CORRECTIVE ACTION
<b>Incorrect wiring</b>	<ul style="list-style-type: none"> <li>➤ Confirm the griddle is wired correctly.</li> <li>➤ Confirm that range is phased correctly.</li> </ul>
<b>Defective Thermostat</b>	<ul style="list-style-type: none"> <li>➤ Confirm that thermostat is wired correctly.</li> <li>➤ Confirm that thermostat is operating correctly.</li> </ul>
<b>Defective Element</b>	<ul style="list-style-type: none"> <li>➤ Confirm that Element is getting correct voltage.</li> <li>➤ Confirm that Element is operating correctly. (See Technical Data)</li> </ul>

## OVEN ELEMENT RESISTANCE

VOLTS	PART #	RESISTANCE	AMPS
➤ 208 Volt	11090-09	7.0 Ω	29
➤ 240 Volt	11090-10	9.6 Ω	25
➤ 480 Volt	11090-11	37.0 Ω	12.5

## HOT TOP RESISTANCE

VOLTS	PART#	PIN #	RESISTANCE	AMPS
208 Volt	11010-341	1-2	46.0 Ω	24
		1-3	68.8 Ω	
		1-4	23.2 Ω	
		2-3	23.0 Ω	
		2-4	23.4 Ω	
		3-4	46.0 Ω	
240 Volt	11010-351	1-2	61.5 Ω	21
		1-3	92.2 Ω	
		1-4	30.9 Ω	
		2-3	30.9 Ω	
		2-4	31.2 Ω	
		3-4	61.8 Ω	
480 Volt	11010-361	1-2	249.0 Ω	10.5
		1-3	372.0 Ω	
		1-4	124.8 Ω	
		2-3	124.2 Ω	
		2-4	124.7 Ω	
		3-4	248.7 Ω	

## FRENCH PLATE RESISTANCE

VOLTS	PART#	PIN #	RESISTANCE	AMPS
208 Volt	11120-12	1-2	130 Ω	12.5
		1-3	160 Ω	
		1-4	45.0 Ω	
		2-3	29.0 Ω	
		2-4	84.0 Ω	
		3-4	114 Ω	
240 Volt	11120-13	1-2	173 Ω	11
		1-3	212 Ω	
		1-4	59.0 Ω	
		2-3	39.0 Ω	
		2-4	114 Ω	
		3-4	153 Ω	
480 Volt	11120-14	1-2	690 Ω	5.5
		1-3	239 Ω	
		1-4	850 Ω	
		2-3	453 Ω	
		2-4	158 Ω	
		3-4	610 Ω	

## GRIDDLE & TOP PLATE ELEMENTS

VOLTS	PART #	RESISTANCE	AMPS
➤ 208 Volt I/S	11010-10	14.5 Ω	14.5
➤ 208 Volt O/S	11010-09	21.5 Ω	9.5
➤ 240 Volt I/S	11010-22	19.0 Ω	12.5
➤ 240 Volt O/S	11010-21	28.0 Ω	8.0
➤ 480 Volt I/S	11010-24	76.0 Ω	6.0
➤ 480 Volt O/S	11010-23	115.0 Ω	4.0

## MOTOR

VOLTS	PART#	AMPS	RPM
208/ 240 Volts	30200-12	32	1725
480 Volts	30200-03	6.6	1725

## 6-HEAT SWITCH WIRING

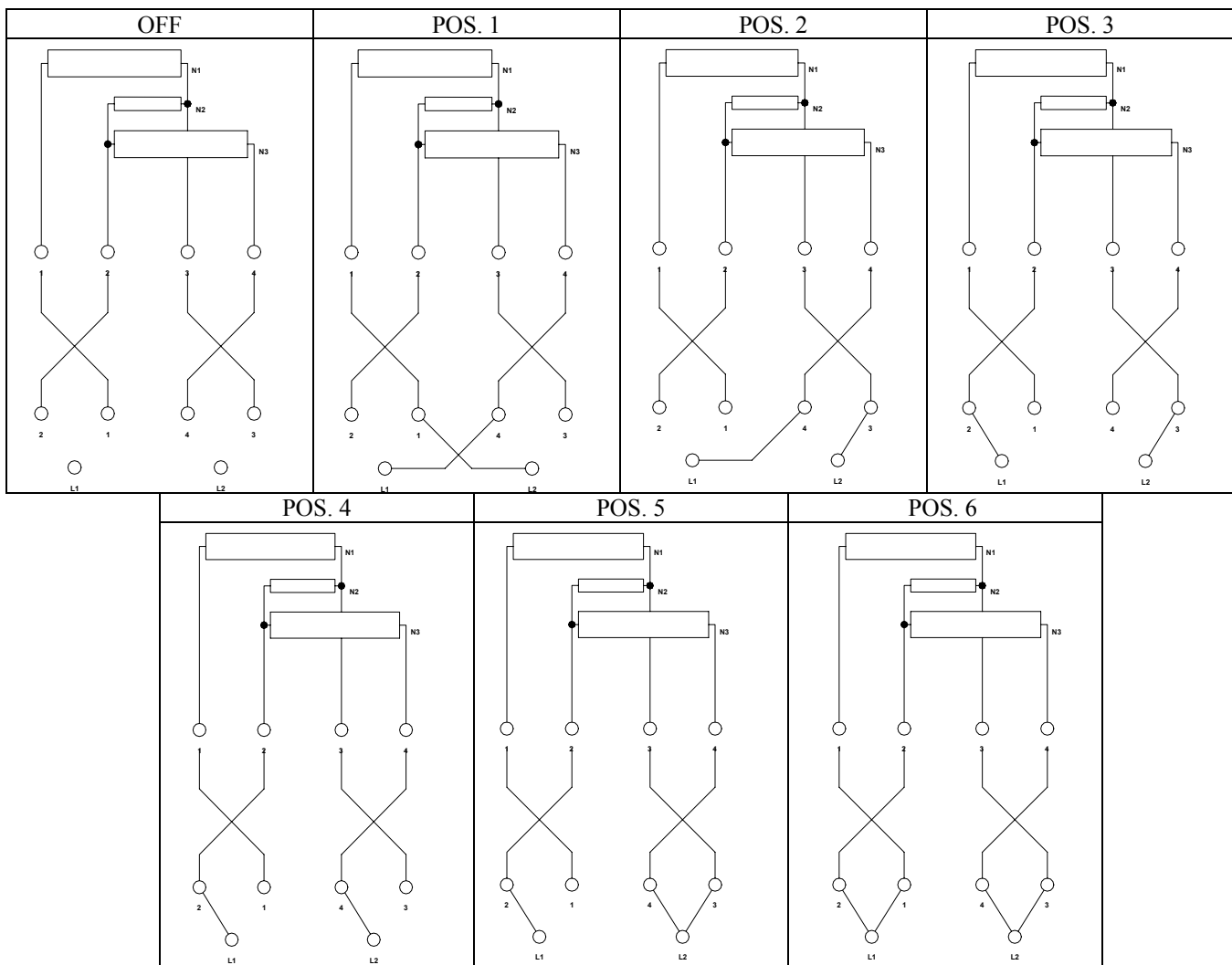

# TECHNICAL DATA CONT'D

## 3-HEAT SWITCH WIRING

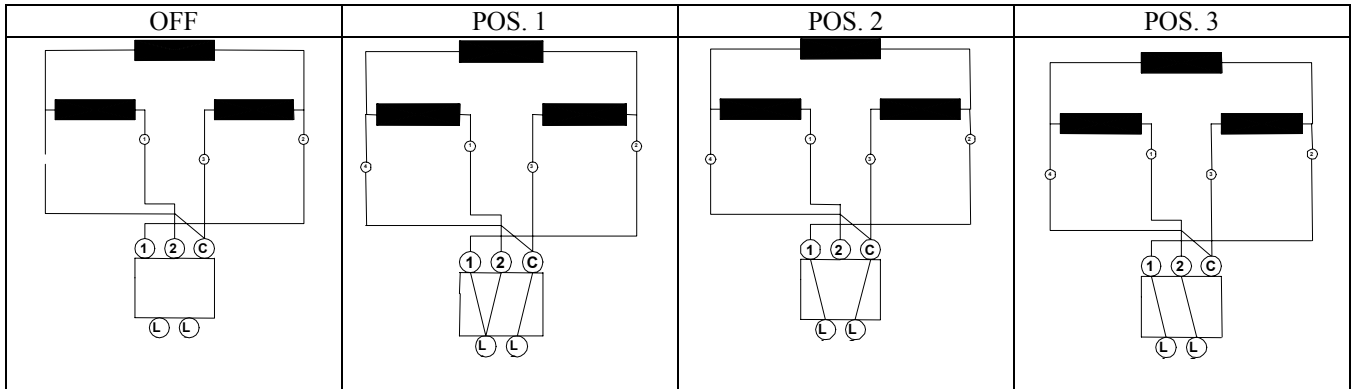

## RANGE AMPERAGE, AND WATTAGE

Model Number	Total K. W. Each Conn.	Nominal Amps Per Line at Each Connection									Shipping Weight			
		Three Phase											Single Phase	
		208 Volts			240 Volts			480 Volts					208V	240V
		L1	L2	L3	L1	L2	L3	L1	L2	L3				
Range	21.0	45.8	66.7	62.5	39.7	57.8	54.2	19.9	28.9	27.1	101.0	87.5	600 lbs.	
Top Only	15.0	41.7	41.7	41.7	36.1	36.1	36.1	18.1	18.1	18.1	72.1	62.5	410 lbs.	

# RF21S WIRING DIAGRAM 208/240

## OVEN WIRING

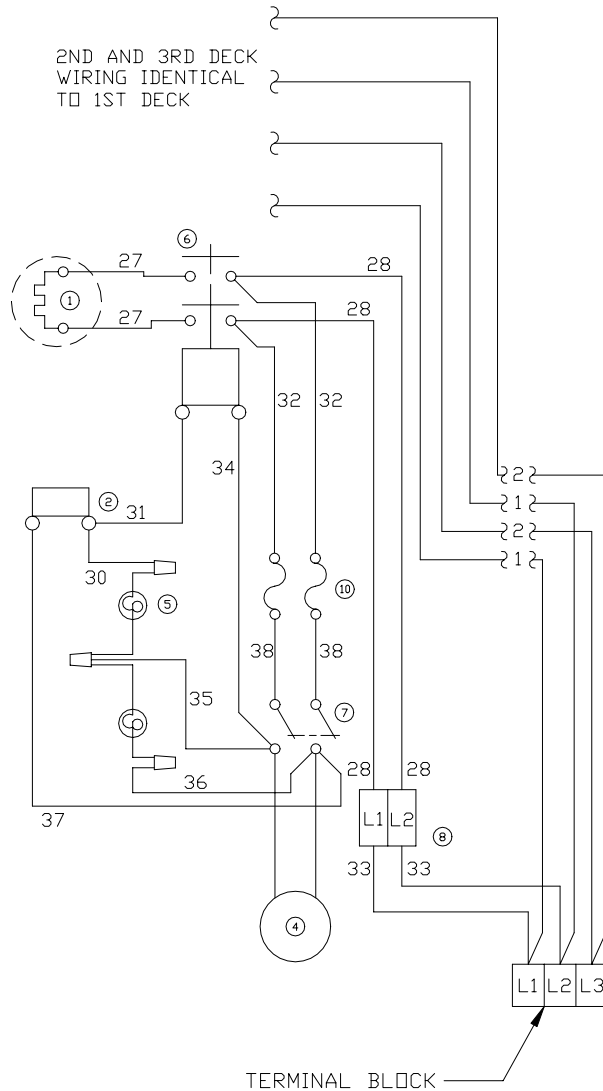

MODEL DESIGNATION	TOP ARRANGEMENT			TOP SECTION WIRE DIAGRAMS											
	SEC-1	SEC-2	SEC-3	A	B	C									
RF219-A	A	A	C												
RF219-C	B	B	B												
RF219-D	B	B	C												
RF219-G	A	A	A												
RF219-H	C	C	C												
① HEAT ELEMENT ② THERMOSTAT ③ 6 HEAT SWITCH ④ MOTOR ⑤ PILOT LAMP ⑥ CONTACTOR ⑦ POWER SWITCH ⑧ CIRCUIT BREAKER ⑨ SPEED UNIT ⑩ FUSE				A	GRILL	B	HOT TOP	C	SPEED UNITS						
CONNECT WIRES FROM RANGE TOP OR ADDITIONAL DECKS TO LOWER OVEN TERMINAL BLOCK AS SHOWN AT RIGHT				ELECTRICAL CONNECTIONS											
				POWER SUPPLY	TERMINAL BLOCK	RANGE TOP	OVEN								
							1st DECK	2nd DECK	3rd DECK						
				SINGLE PHASE	L1	1-3-5	1	1	1						
THREE PHASE	L2	2-4-6	2	2	2										
	L1	3	1	1	-										
	L2	1-5	2	-	1										
	L3	2-4-6	-	2	2										
ELECTRICAL DATA															
MODEL NUMBER	LOADING					KW TOTAL	THREE PHASE AMPS						SINGLE PHASE AMPS		
	KW PER PHASE						208 VOLT			240 VOLT			208V		240V
	L1	L2	L2	L3	L3		L1	L2	L3	L1	L2	L3	208V	240V	
RF-21S	6.6	10.0	5.0	21.6	48.3	69.2	62.5	41.9	59.9	54.2	103.8	90.0			
1F-6S	6.6	0.0	0.0	6.6	31.7	31.7	00.0	27.5	27.5	0.0	31.7	27.5			
2F-6S	6.6	0.0	6.6	13.2	55.0	31.7	31.7	47.7	27.5	27.5	63.5	55.0			
3F-6S	6.6	6.6	6.6	19.8	55.0	55.0	55.0	47.7	47.7	47.7	95.2	82.5			

USE ON ALL E SERIAL NUMBERS

# RANGE TOP WIRING

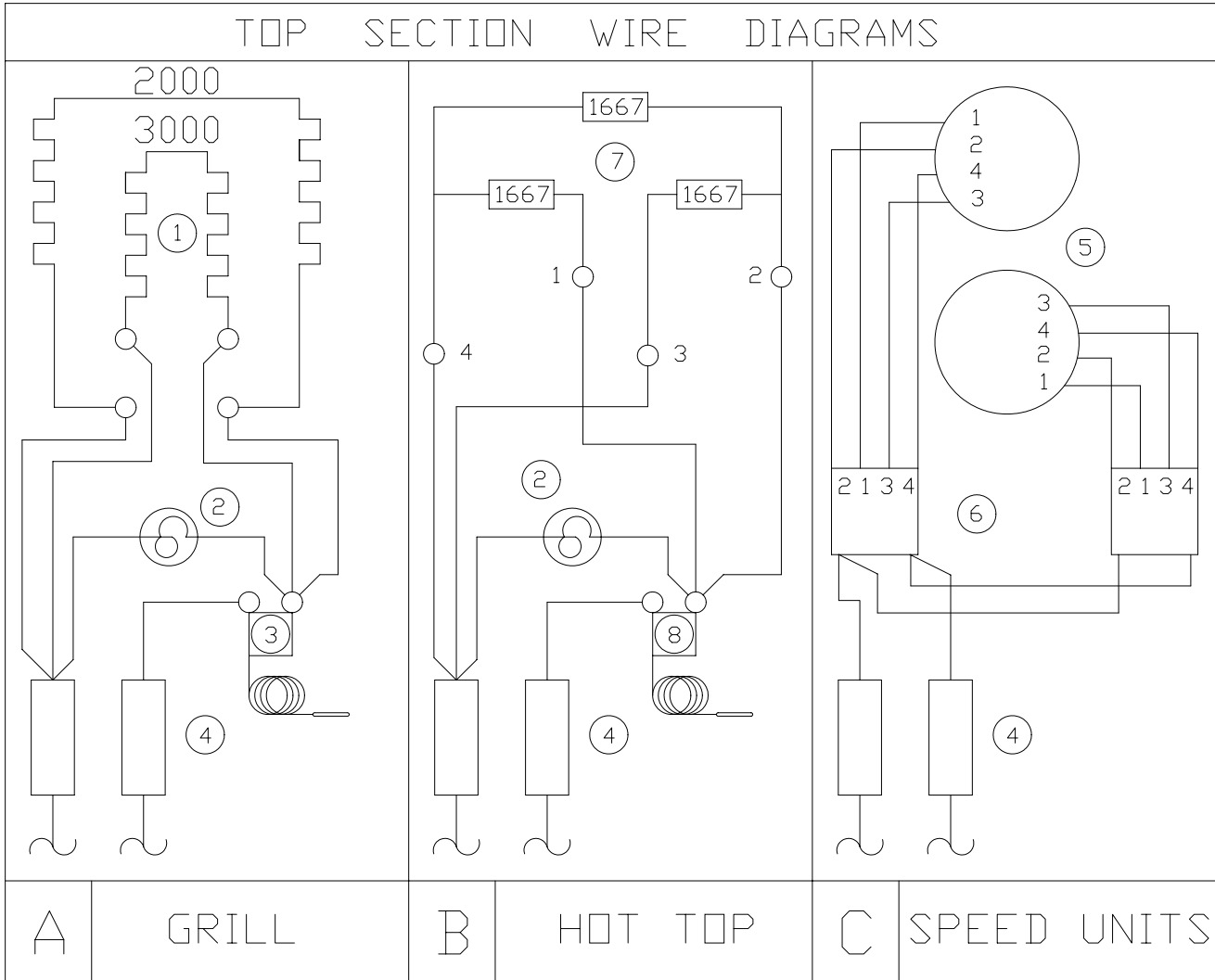

1. Griddle and Top Plate Element
2. Pilot Light
3. 450° Griddle thermostat
4. Circuit breakers
5. French plate
6. 6-Heat switch
7. Hot Top
8. 850° Hot Top thermostat.

# RF21S 480 WIRING DIAGRAM

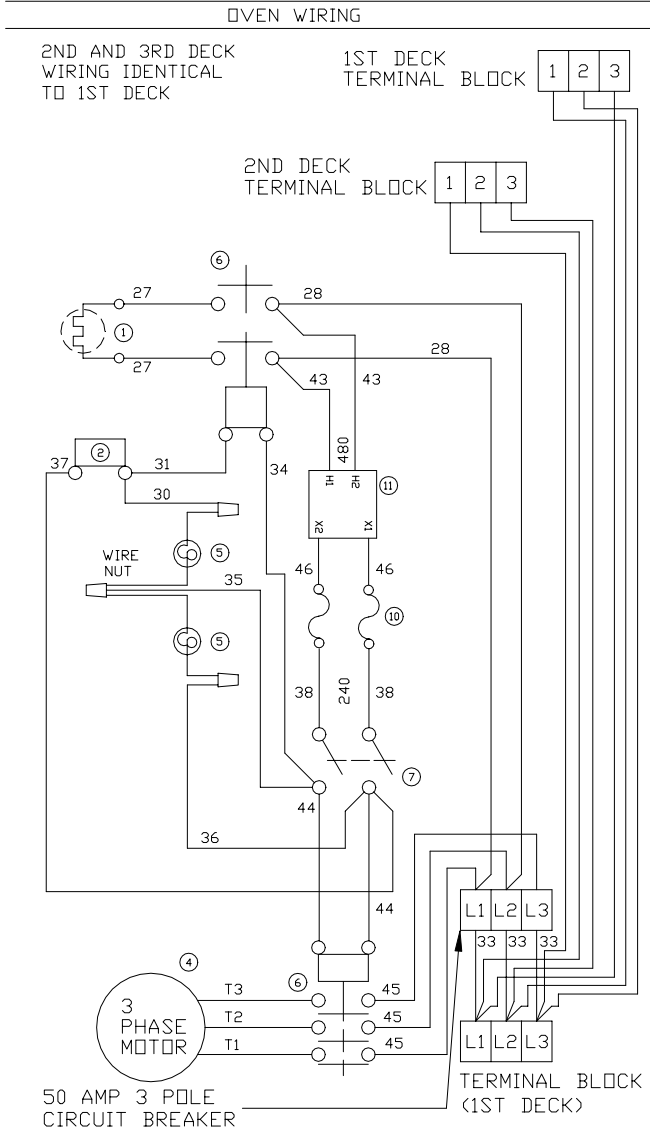

MODEL DESIGNATION	TOP ARRANGEMENT			TOP SECTION WIRE DIAGRAMS		
	SEC-1	SEC-2	SEC-3	2000	3000	
RF21S-A	A	A	C			
RF21S-C	B	B	B			
RF21S-D	B	B	C			
RF21S-G	A	A	A			
RF21S-H	C	C	C			

①	HEAT ELEMENT
②	THERMOSTAT
③	6 HEAT SWITCH
④	MOTOR
⑤	PILOT LAMP
⑥	CONTACTOR
⑦	POWER SWITCH
⑧	SPEED UNIT
⑩	FUSE
⑪	TRANSFORMER

OVEN 3 POLE CIRCUIT BREAKER

TO BREAKER

TO BREAKER

TO BREAKER

CONNECT WIRE FROM RANGE TOP TO OVEN CIRCUIT BREAKER. CONNECT WIRES FROM ADDITIONAL DECKS TO LOWER OVEN TERMINAL BLOCK

ELECTRICAL CONNECTIONS				
POWER SUPPLY	RANGE TOP CONNECT TO OVEN CIRCUIT BREAKER	UPPER OVENS CONNECT TO BOTTOM DECK TERMINAL BLOCK		
		1st DECK	2nd DECK	3rd DECK
THREE PHASE	L1	3	1	2
	L2	1-5	2	3
	L3	2-4-6	3	1

MODEL NUMBER	LOADING						TOTAL CONN. LOAD	AMPS THREE PHASE 480 VAC		
	L1 L2		L2 L3		L3 L1			L1	L2	L3
	L1	L2	L2	L3	L3	L1				
RF-21S	6.2	10.2	5.2	21.6	20.1	29.5	27.7			
1F-6S	6.2	0.2	0.2	6.6	13.2	13.2	.66			
2F-6S	6.4	0.4	6.4	13.2	23	13.9	13.9			
3F-6S	6.6	6.6	6.6	19.8	23.6	23.6	23.6			

CAUTION: CHECK OVEN FOR PROPER DIRECTION OF FAN ROTATION

CHANGE PHASING OF POWER IF NECESSARY TO CORRECT

USE ON ALL E SERIAL NUMBERS

**RF21S****ELECTRIC RANGE**

<b>DESCRIPTION</b>	<b>PART NO.</b>
Element Top Plate 208V O/S 2000 Watts	11010-09
Element Top Plate 208V I/S 3000 Watts	11010-10
Element Top Plate 240V O/S 2000 Watts	11010-21
Element Top Plate 240V I/S 3000 Watts	11010-22
Element Top Plate 480V O/S 2000 Watts	11010-23
Element Top Plate 480V I/S 3000 Watts	11010-24
Element Top Plate 380V O/S 2000 Watts (Marine Units Only)	11010-25
Element Top Plate 380V I/S 3000 Watts (Marine Units Only)	11010-26
Hot Plate Cast Assy. w/ Elements 208V 5000 Watts (After E-86751)	11010-341
Hot Plate Cast Assy. w/ Elements 240V 5000 Watts (After E-86751)	11010-351
Hot Plate Cast Assy. w/ Elements 480V 5000 Watts (After E-86751)	11010-361
Element 10 x 10 208 Volt 1000 Watts (Before C-35556)	11020-02
Element 10 x 10 480 Volt 1000 Watts (Before C-35556)	11020-04
Element 10 x 10 240 Volt 1000 Watts (Before C-35556)	11020-06
Element F6 Oven 240 Volt 6000 Watts	11090-09
Element F6 Oven 240 Volt 6000 Watts	11090-10
Element F6 Oven 480 Volt 6000 Watts	11090-11
Element F6 Oven 380 Volt 6000 Watts	11090-28
Element Speed Unit 208 Volt 2100 Watts (Before C-43466)	11120-01
Element Speed Unit 240 Volt 2100 Watts (Before C-43466)	11120-02
Element Speed Unit 480 Volt 2100 Watts (Before C-35556)	11120-10
Element French Plate 208 Volt 2600 Watts (After D-43467)	11120-12
Element French Plate 240 Volt 2600 Watts (After D-43467)	11120-13
Element French Plate 480 Volt 2600 Watts (After C-35556)	11120-14
Speed Unit Bowl 208/240 Volt (Before C-43466)	11120-15
Speed Unit Spider 208/240 Volt (Before C-43466)	11120-16
Element French Plate 380 Volt 2000 Watts (Marine Units Only)	11120-18
Speed Unit Ring 208/240 Volt (Before C-43466)	11120-19
Speed Unit Bowl/Ring Assembly 480 Volt (Before C-35556)	11120-20
Thumb Screws 1/2-20 x 3/4" (Marine Units Only)	20112-01
Motor 1/3 HP 480 Volt	30200-03
Motor 1/3 HP 208/240 Volt	30200-12
Switch Toggle On-Off-On	30303-03
Switch Toggle On-Off	30303-06
Switch Rotating 3 Heat (Before C-43466)	30304-06
Switch Rotating 6 Heat + Off (After C-35556)	30304-09
Switch Infinite Control (Before C-35556)	30305-01
Switch Rocker On-Off (Before C-35556)	30306-01
Thermostat 450°F Oven/Griddle	30402-08
Thermostat 800°F Hot Top (Before C-35556)	30402-10
Thermostat 180°F Oven Cook & Hold	30402-21
Thermostat 850°F Hot Top (After C-35556)	30402-23
Thermostat 450°F Oven (After D-46305)	30402-27
Terminal Block 3 Pole	30500-07
Relay 240 VAC	30600-02
Contactors 3 Pole 208/240 VAC	30700-05
Contactors 2 Pole 208/240 VAC	30701-02
Timer Electric 12 Hour	30800-04
Timer Mechanical Long Ring	30801-01
Buzzer Electric Timer	30802-01
Fuse 15 Amp	30900-01
Fuse 6 1/4 Amp (Before D-46304)	30900-05

**RF21S****ELECTRIC RANGE**

<b>DESCRIPTION</b>	<b>PART NO.</b>
Fuse Holder 15 Amp	30901-02
Transformer 480/240 VAC	31400-04
Transformer 380/240 VAC (Marine Units Only)	31400-17
Pilot Light 208/240V 6" Lead Black Body	31601-01
Pilot Light 480V 6" Lead Black Body	31601-02
Pilot Light Rectangular 250 Volt (Before C-35556)	31601-06
Circuit Breaker 208/240 Volt 1 Pole	31800-01
Circuit Breaker 480 Volt 3 Pole	31800-04
Circuit Breaker 480 Volt 2/10 Amp 2 Pole (Marine Units Only)	31800-07
Element Pan Assembly w/ Snout	50300-20
Speed Unit Frame Assembly (Before C-43466)	50300-29
Grab Bar Assembly 36" Long (Cruise Line Only)	50300-32
Grab Bar Assembly 36" Long (Marine Units Only)	50300-44
Pan Latch Assembly (Marine Units Only)	50300-63
Door Striker Plate (Marine Units Only)	50300-68
French Plate Frame Assembly (After C-35556)	50300-82
Door Stop & Slide (Marine Units Only)	50301-50
Hot Top Assembly 3/4" x 1ft (Before D-86750)	50400-02
Range Plate Assembly 1/2" x 1ft	50401-01
Range Plate Assembly 1/2" x 2ft	50401-02
Range Plate Assembly 1/2" x 3ft	50401-03
Range Plate Assembly 1" x 4ft	50401-11
Range Plate Assembly 1" x 5ft	50401-12
Range Plate Assembly 1" x 6ft	50401-13
Door Handle 11 1/2" Long Black "T" Style	50800-12
Ship Rail 13" (Marine Units Only)	50900-01
Ship Rail 24" (Marine Units Only)	50900-02
Ship Rail 35 3/8" (Marine Units Only)	50900-04
Ship Rail Hooked 11 3/8" (Marine Units Only)	50901-01
Ship Rail Hooked 32 1/4" (Marine Units Only)	50901-04
Ship Rail Socket Front (Marine Units Only)	60102-981
Ship Rail Socket Rear (Marine Units Only)	60102-982
Pan/Grease Drawer	60102-29
Hinge 1-1/8" Offset (Before C-35556)	70601-03
Hinge Plate & Bushing (Door)	70601-05
Hinge Pin	70601-06
Hinge Bracket, Upper Left (Oven)	70601-27
Hinge Bracket, Lower Left (Oven)	70601-28
Knob Infinite Control (Before C-35556)	70701-04
Knob Manual Timer	70701-09
Knob 3 Heat Switch (Before C-43466)	70701-10
Knob Thermostat 450°F Griddle/Oven	70701-16
Knob Thermostat 450°F Oven	70701-19
Knob Thermostat 800°F Hot Top (Before C-35556)	70701-20
Knob Damper Black	70701-25
Knob Thermostat Cook & Hold	70701-34
Knob Thermostat 850°F Hot Top (After C-35556)	70701-35
Knob 6 Heat Switch (After C-35556)	70701-41
Blower Wheel	71500-03