

RRB & RSRB RADIANT BROILER

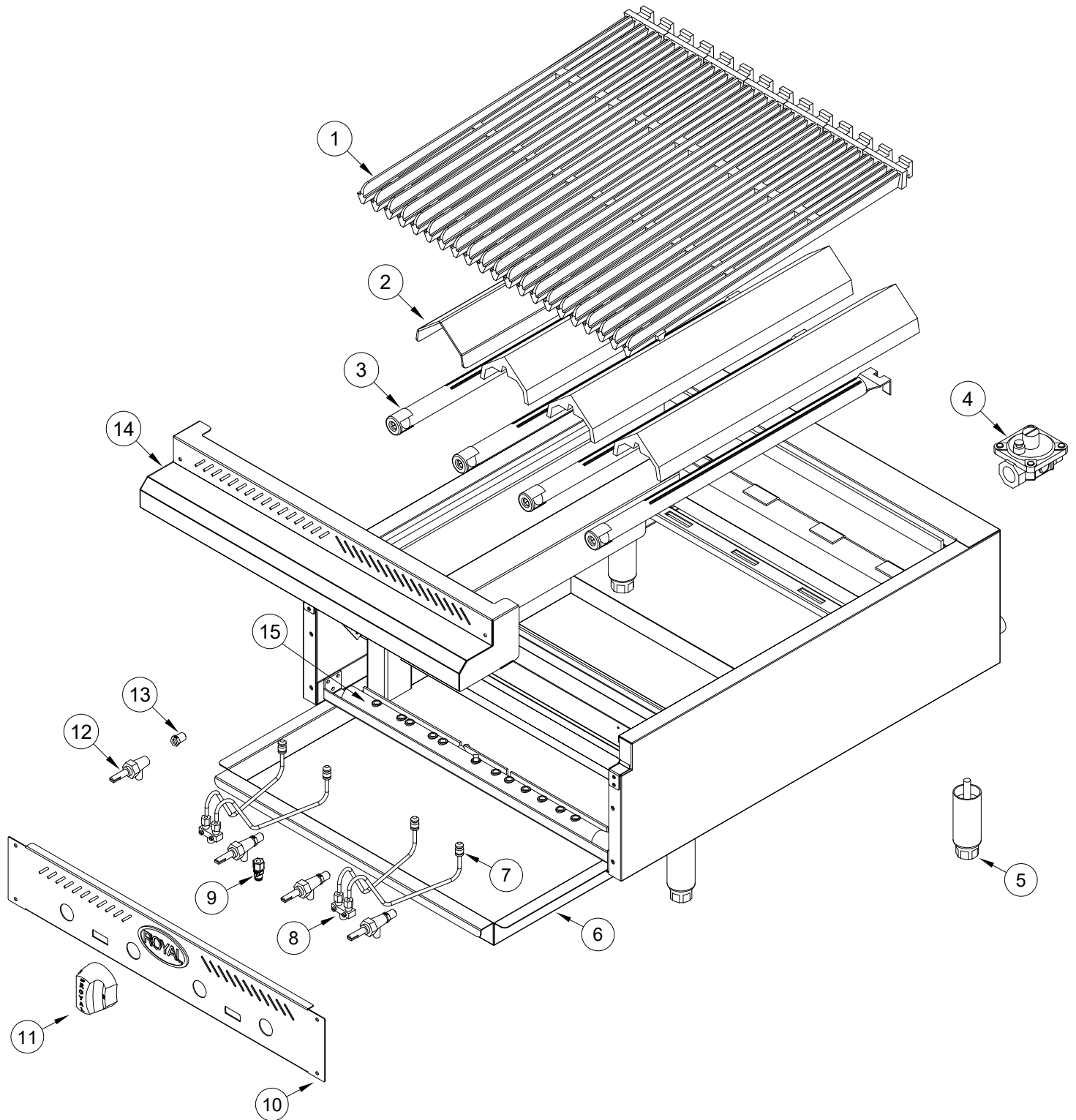

PILOT TIP ASSY

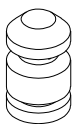

7

DUAL PILOT VALVE

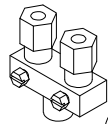

8

PILOT VALVE

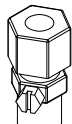

9

ON/OFF KNOB

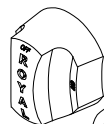

11

GAS VALVE

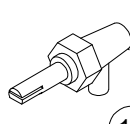

12

ORIFICE HOOD

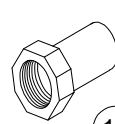

13

RRB & RSRB

Radiant Broiler

ITEM NO.	PART NO.	DESCRIPTION
1	6504	5" x 23" Top Grate (Cast Iron) For H/D Series
	1901	5" x 18" Top grate (3 or 4 bar fish cast iron grate) For snack series
2	1902	Burner radiant (cast iron) for H/D series
	1903	Burner radiant (cast iron) for snack series
3	1904	Stainless steel burner w/ air shutter (H/D series)
	1905	Burner w/ air shutter (snack series)
4	1618	Gas pressure regulator (natural gas)
	1619	Gas pressure regulator (propane Gas)
5	3604	4" Adjustable leg
6	31209	Crumb tray – 12 for RRB-12
	31210	Crumb tray – 18 for RRB-18
	31211	Crumb tray – 24 for RRB-24
	31212	Crumb tray – 30 for RRB-30
	31213	Crumb tray – 36 for RRB-36
	31214	Crumb tray – 48 for RRB-48
	32007	Crumb tray – 12 for RSRB-12
	32008	Crumb tray – 18 for RSRB-18
	32009	Crumb tray – 24 for RSRB-24
	32010	Crumb tray – 30 for RSRB-30
	32011	Crumb tray – 36 for RSRB-36
32012	Crumb tray – 48 for RSRB-48	
7	1937	Pilot tip assembly (Right side)
	1938	Pilot tip assembly (Left side)
8	1211	1/8" NPT x 3/16" CC Adjustable double pilot valve (brass)
9	1124	1/8" NPT x 3/16" CC straight single pilot valve (brass)
10	32586	Valve cover – 12 for RRB-12/RSRB-12
	32494	Valve cover – 18 for RRB-18/RSRB-18
	32326	Valve cover – 24 for RRB-24/RSRB-24
	32415	Valve cover – 30 for RRB-30/RSRB-30
	32433	Valve cover – 36 for RRB-36/RSRB-36
	32509	Valve cover – 48 for RRB-48/RSRB-48
	32562	Valve cover – 60 for RRB-60/RSRB-60
32672	Valve cover – 72 for RRB-72/RSRB-72	
11	3095	knob
12	1628	Gas valve (brass) w/out orifice
13	1121-50	Orifice hood #50 (brass) natural gas (RRB) 15,000 BTU
	1122-56	Orifice hood #56 (brass) propane gas (RRB) 15,000 BTU
	1121-52	Orifice hood #52 (brass) natural gas (RSRB) 12,500 BTU
	1122-59	Orifice hood #59 (brass) propane gas (RSRB) 12,500 BTU

14	32391	Landing ledge – 12 for RRB-12/RSRB-12
	32493	Landing ledge – 18 for RRB-18/RSRB-18
	32393	Landing ledge – 24 for RRB-24/RSRB-24
	32394	Landing ledge – 30 for RRB-30/RSRB-30
	32395	Landing ledge – 36 for RRB-36 /RSRB-36
	32396	Landing ledge – 48 for RRB-48/RSRB-48
	32397	Landing ledge – 60 for RRB-60/RSRB-60
	32682	Landing ledge – 72 for RRB-72/RSRB-72
15	1049	Manifold pipe – 12 for RRB-12
	1050	Manifold pipe – 18 for RRB-18
	1051	Manifold pipe – 24 for RRB-24
	1052	Manifold pipe – 30 for RRB-30
	1053	Manifold pipe – 36 for RRB-36
	1054	Manifold pipe – 48 for RRB-48
	1055	Manifold pipe – 60 for RRB-60
	1056	Manifold pipe – 72 for RRB-72
	1057	Manifold pipe – 12 for RSRB-12
	1058	Manifold pipe – 18 for RSRB-18
	1059	Manifold pipe – 24 for RSRB-24
	1060	Manifold pipe – 30 for RSRB-30
	1061	Manifold pipe – 36 for RSRB-36
1062	Manifold pipe – 48 for RSRB-48	

041724