

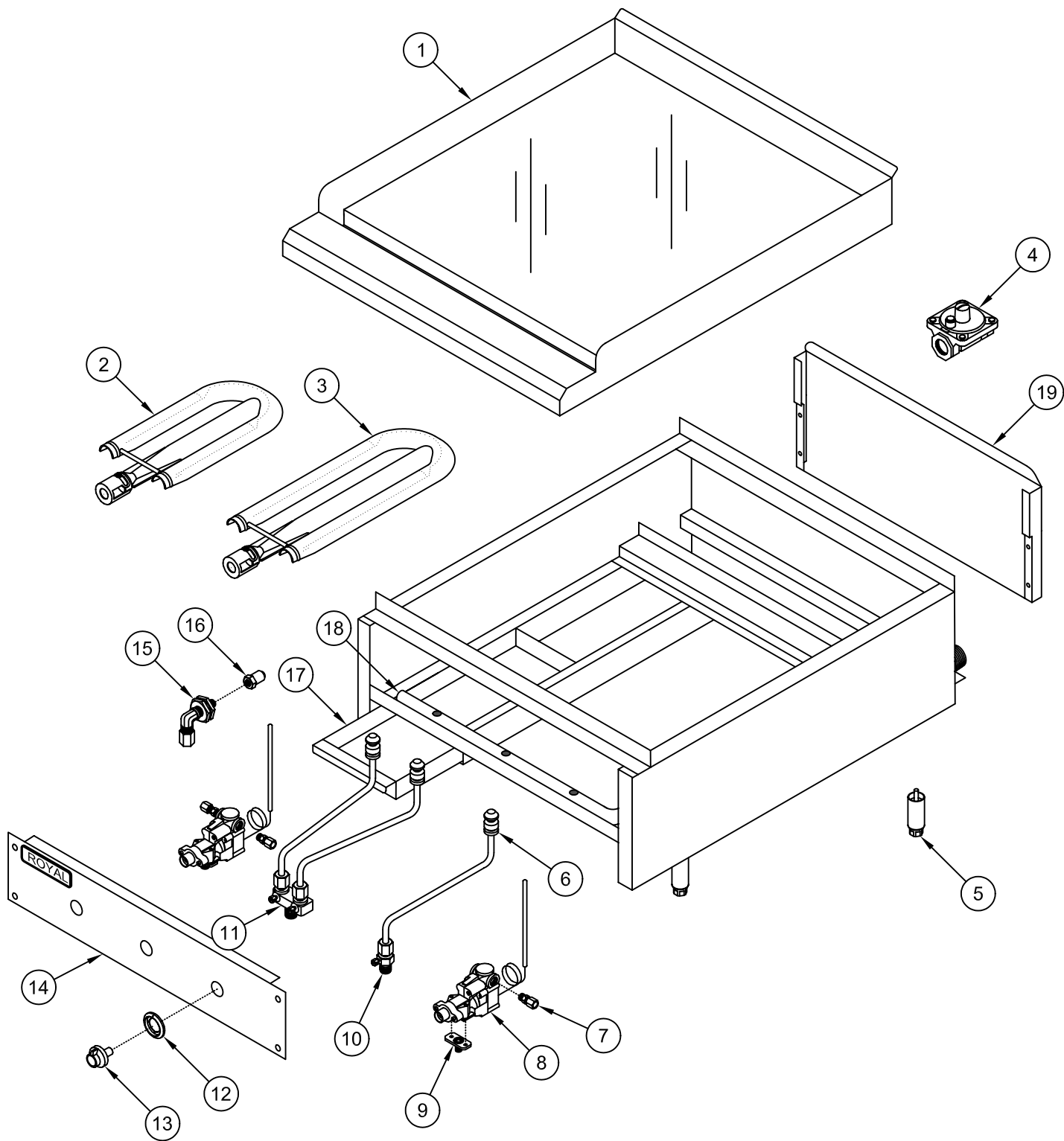

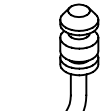

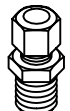

RTG & RSTG

Thermostat Griddle

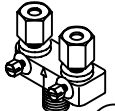

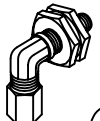
PILOT TIP ASSY	BRASS FITTING	"TEE" FLANGE	SINGLE PILOT	DUAL PILOT VALVE	BEZEL	THERMOSTAT KNOB	ORIFICE ELBOW	ORIFICE HOOD
 6	 7	 9	 10	 11	 12	 13	 15	 16

RTG & RSTG

Thermostat Griddle

ITEM NO.	PART NO.	DESCRIPTION
1	31065	24" Griddle plate assy. (with 3/4" thick plate)
	31066	36" Griddle plate assy. (with 3/4" thick plate)
	31067	48" Griddle plate assy. (with 3/4" thick plate)
	31068	60" Griddle plate assy. (with 1" thick plate)
	31069	72" Griddle plate assy. (with 1" thick plate)
	31071	18" Griddle plate assy. (for RSTG – 18 with 3/4" thick plate)
	31072	24" Griddle plate assy. (for RSTG – 24 with 3/4" thick plate)
	31073	36" Griddle plate assy. (for RSTG – 36 with 3/4" thick plate)
2	2610	RSMG / RSTG Burner
3	2611	RMG / RTG Burner
4	1618	Gas pressure regulator (natural gas)
	1619	Gas pressure regulator (propane Gas)
5	3604	4" Adjustable leg
6	1521	Pilot tip assembly
7	1509	1/4" NPT x 3/8" CC Straight fitting (brass)
8	1520	B.J. Thermostat (griddle only)
	1519	1/4" NPT Plug (used to block outlet on thermostat)
9	1525	B.J. Thermostat flange
10	1120	1/8" NPT x 3/16" CC Adjustable single pilot valve (brass)
11	1211	1/8" NPT x 3/16" CC Adjustable double pilot valve (brass)
12	1518	Thermostat bezel (chrome)
13	1517	Thermostat dial (black)
14	30948	RTG / RSTG-24 Valve cover
	30968	RTG / RSTG-36 Valve cover
	30978	RTG / RSTG-48 Valve cover
	30988	RTG / RSTG-60 Valve cover
	30998	RTG / RSTG-72 Valve cover
15	1508	3/8" CC x 3/8-27 Orifice elbow (brass)
16	1121-46	Orifice hood # 46 (brass) natural gas. (RSTG), 20,000 BTU
	1122-55	Orifice hood # 55 (brass) propane gas. (RSTG), 20,000 BTU
	1121-39	Orifice hood # 39 (brass) natural gas. (RTG), 30,000 BTU
	1122-52	Orifice hood # 52 (brass) propane gas (RTG), 30,000 BTU

17	31000	Grease can assy.
18	1024	12 Manifold pipe for RTG
	1025	18 Manifold pipe for RTG
	1026	24 Manifold pipe for RTG
	1027	36 Manifold pipe for RTG
	1028	48 Manifold pipe for RTG
	1029	60 Manifold pipe for RTG
	1030	72 Manifold pipe for RTG
	1031	12 Manifold pipe for RTG
	1032	18 Manifold pipe for RSTG
	1033	24 Manifold pipe for RSTG
19	1034	36 Manifold pipe for RSTG
	1035	48 Manifold pipe for RSTG
	30923	12" Flue Back
	30933	18" Flue Back
	30943	24" Flue Back
	30953	30" Flue Back
	30963	36" Flue Back
30973	48" Flue Back	
30983	60" Flue Back	
30993	72" Flue Back	