

- 1.1 Outside View – Verismo 701
- 1.2 Outside View – Ambiente PS

- 2.1 Steam Boiler – Boiler View
 - 2.1.1 Steam Boiler – Boiler Upgrade
- 2.2 Steam Boiler – Steam Valve
- 2.3 Steam Boiler – Steam Wand

- 3.1 Hot Water Boiler – Top View
- 3.2 Hot Water Boiler – Bottom View
- 3.3 Hot Water Boiler – Coffee Spout
 - 3.3.1 Hot Water Boiler – Coffee Spout

- 4.1 Pump
- 4.2 Pump – Flow Meter

- 5.1 Automat
- 5.2 Automat – Motor

- 6.1 Grinder
- 6.2 Grinder – Bean Hopper

- 7.0 Electronics – Overview
 - 7.1 Electronics – Main Board
 - 7.2 Electronics – Transformer / Voltage Regulator
 - 7.3 Electronics – Power Supply
 - 7.4 Electronics – Display Panel
 - 7.5 Electronics – Miscellaneous

- 8.1 Miscellaneous – Accessories
- 8.2 Miscellaneous – Tools / Parts
- 8.3 Miscellaneous – Parts
 - 8.3.1 Miscellaneous – Parts

- 9.1 PC Board Layout – Left Side
- 9.2 PC Board Layout – Bottom Side
- 9.3 PC Board Layout – Upper Right Side

- 10.1 Machine Overview – Electrical Schematic
- 10.2 Machine Overview – Water Flow Chart

1001016 Hex Screw f.Lid (not shown)
63083 Decaf Lid
63639 Hopper Sleeve (not shown)
67344 Hopper Ring
1999020 Security Screw
63001B Panel Plate
63000B Front Panel
63628 Decal
61002 Side Panel left
63601 Protection
63622 Steam Wand
63081 Front Plate left
63632 Steam Tip
63086 Bin Plate
63004 Grounds Bin
63079 Drip Grill
1019009 Nut M 10
1064007 Washer M 10
63836 Machine Foot

67230 Funnel
1060010 Washer
1220001 Nut M3 (not shown)
67346 Hopper Lid
67345 Bean Hopper
63690 Cup Plate
50373 Bean Slide
1001017 Screw
63561 Cup Frame
61095 Fan (not shown)
61039 Wire Tree to Fan (not shown)
63434 Grill to Fan (not shown)
61001 Back Panel for 24 Volt Motor (fan not included)
61734 Back Panel for 36 Volt Motor (fan not included)
61003 Side Panel right
UL Sticker
63711 Pressure Gauge
NSF Sticker
63601 Protection
63216 Hot Water Wand
63090 Center Plate
63080 Front Plate right
65724 Coffee Spout
1042050 Drip Tray Screw (not shown)
66951 Nut Clip M4 (not shown)
63003B Drip Tray Black

<table border="1" style="width: 100%; border-collapse: collapse;"> <tr><td>1999020 Security Screw (not shown)</td></tr> <tr><td>65192 O-Ring (not shown)</td></tr> <tr><td>63005 Decaf Lid</td></tr> <tr><td>63073 Cup Plate</td></tr> <tr><td>63075 Cup Frame</td></tr> <tr><td>1999020 Security Screw</td></tr> <tr><td>63088 Panel Cup Plate</td></tr> <tr><td>63001 Panel Cover</td></tr> <tr><td>63000 Front Panel</td></tr> <tr><td>63961 Logo</td></tr> </table> <table border="1" style="width: 100%; border-collapse: collapse;"> <tr><td>63065 Side Panel left</td></tr> <tr><td>63601 Protection</td></tr> <tr><td>63622 Steam Wand</td></tr> <tr><td>63081 Front Plate left</td></tr> <tr><td>63632 Steam Tip</td></tr> <tr><td>63086 Bin Plate</td></tr> <tr><td>63004 Grounds Bin</td></tr> <tr style="background-color: #ffff00;"><td>63079 Drip Grill</td></tr> <tr><td>63094 Drain Fitting (not shown)</td></tr> <tr><td>63095 Drain Nut (not shown)</td></tr> </table> <table border="1" style="width: 100%; border-collapse: collapse;"> <tr><td>1019009 Nut M 10</td></tr> <tr><td>1064007 Washer M 10</td></tr> <tr><td>63836 Machine Foot</td></tr> </table>	1999020 Security Screw (not shown)	65192 O-Ring (not shown)	63005 Decaf Lid	63073 Cup Plate	63075 Cup Frame	1999020 Security Screw	63088 Panel Cup Plate	63001 Panel Cover	63000 Front Panel	63961 Logo	63065 Side Panel left	63601 Protection	63622 Steam Wand	63081 Front Plate left	63632 Steam Tip	63086 Bin Plate	63004 Grounds Bin	63079 Drip Grill	63094 Drain Fitting (not shown)	63095 Drain Nut (not shown)	1019009 Nut M 10	1064007 Washer M 10	63836 Machine Foot		<table border="1" style="width: 100%; border-collapse: collapse;"> <tr><td>65023 Hopper lid</td></tr> <tr><td>63002 Bean Hopper</td></tr> <tr><td>61095 Fan (not shown)</td></tr> <tr><td>61039 Wire Tree to Fan (not shown)</td></tr> <tr><td>63434 Grill to Fan (not shown)</td></tr> <tr><td>61241 Back Panel for 24 Volt Motor (fan not included)</td></tr> <tr><td>61334 Back Panel for 36 Volt Motor (fan not included)</td></tr> <tr><td>63069 Side Panel right</td></tr> <tr><td>63628 Decal</td></tr> <tr><td>63033 Button White</td></tr> <tr><td>63032 Button Black</td></tr> <tr><td>UL Sticker</td></tr> <tr><td>NSF Sticker</td></tr> <tr><td>63601 Protection</td></tr> <tr><td>63711 Pressure Gauge</td></tr> <tr><td>63216 Hot Water Wand</td></tr> <tr><td>63090 Center Plate</td></tr> <tr><td>63080 Front Plate right</td></tr> <tr><td>1042050 Drip Tray Screw (not shown)</td></tr> <tr><td>66951 Nut Clip (not shown)</td></tr> <tr><td>65724 Coffee Spout</td></tr> <tr><td>63003 Drip Tray</td></tr> </table>	65023 Hopper lid	63002 Bean Hopper	61095 Fan (not shown)	61039 Wire Tree to Fan (not shown)	63434 Grill to Fan (not shown)	61241 Back Panel for 24 Volt Motor (fan not included)	61334 Back Panel for 36 Volt Motor (fan not included)	63069 Side Panel right	63628 Decal	63033 Button White	63032 Button Black	UL Sticker	NSF Sticker	63601 Protection	63711 Pressure Gauge	63216 Hot Water Wand	63090 Center Plate	63080 Front Plate right	1042050 Drip Tray Screw (not shown)	66951 Nut Clip (not shown)	65724 Coffee Spout	63003 Drip Tray
1999020 Security Screw (not shown)																																															
65192 O-Ring (not shown)																																															
63005 Decaf Lid																																															
63073 Cup Plate																																															
63075 Cup Frame																																															
1999020 Security Screw																																															
63088 Panel Cup Plate																																															
63001 Panel Cover																																															
63000 Front Panel																																															
63961 Logo																																															
63065 Side Panel left																																															
63601 Protection																																															
63622 Steam Wand																																															
63081 Front Plate left																																															
63632 Steam Tip																																															
63086 Bin Plate																																															
63004 Grounds Bin																																															
63079 Drip Grill																																															
63094 Drain Fitting (not shown)																																															
63095 Drain Nut (not shown)																																															
1019009 Nut M 10																																															
1064007 Washer M 10																																															
63836 Machine Foot																																															
65023 Hopper lid																																															
63002 Bean Hopper																																															
61095 Fan (not shown)																																															
61039 Wire Tree to Fan (not shown)																																															
63434 Grill to Fan (not shown)																																															
61241 Back Panel for 24 Volt Motor (fan not included)																																															
61334 Back Panel for 36 Volt Motor (fan not included)																																															
63069 Side Panel right																																															
63628 Decal																																															
63033 Button White																																															
63032 Button Black																																															
UL Sticker																																															
NSF Sticker																																															
63601 Protection																																															
63711 Pressure Gauge																																															
63216 Hot Water Wand																																															
63090 Center Plate																																															
63080 Front Plate right																																															
1042050 Drip Tray Screw (not shown)																																															
66951 Nut Clip (not shown)																																															
65724 Coffee Spout																																															
63003 Drip Tray																																															

67068	Level Probe
63318	Temp. Sensor
67060	Washer (not shown)
65135	Klixon Support
63209	Klixon 155C
65135	Klixon Support
63209	Klixon 155C

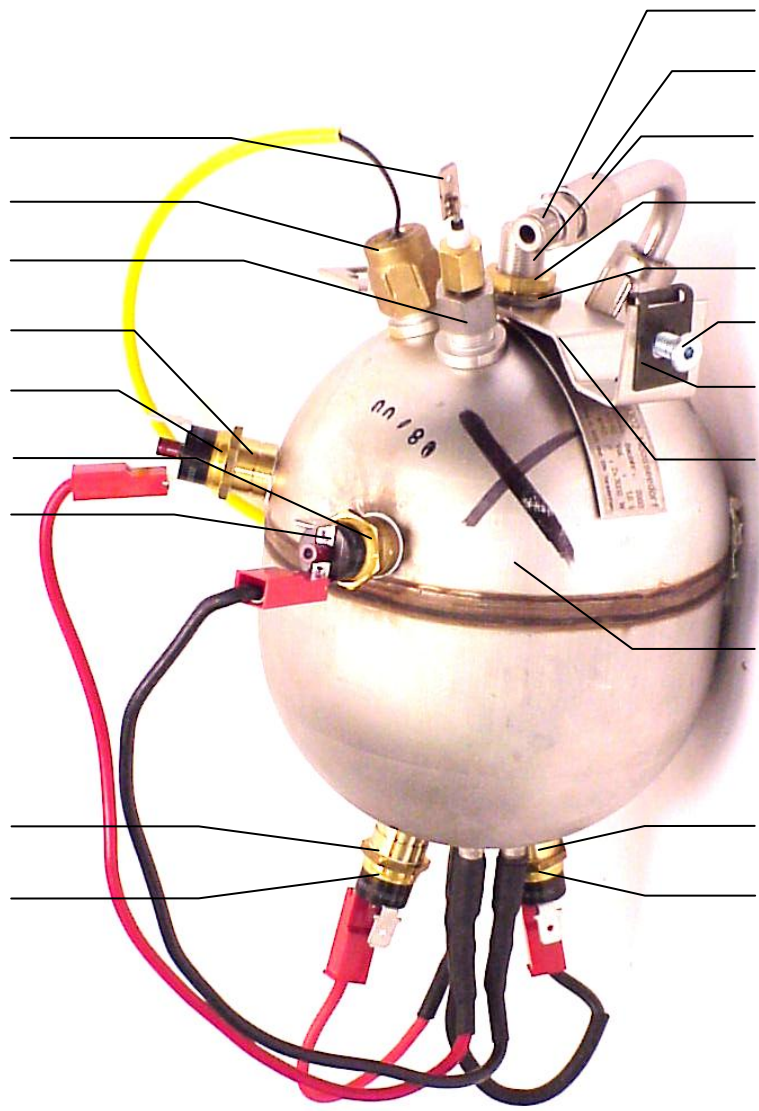

63672	Adapter 8-6
63304	Inlet Tube Steam
65204	Nut M12
1060017	Washer M 12
64241	Gasket (not shown)
1999010	Screw
66164	Nut Clip M6
63620	Bracket Steam

63621	Steam Boiler 6Kw
-------	------------------

65135	Klixon Support
63209	Klixon 155C

65135	Klixon Support
63209	Klixon 155C

63462	Inlet Tube Teflon
67060	Washer
64241	Gasket

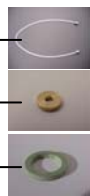

63659	T - Piece
63664	Nut 8
63666	Clamp Ring

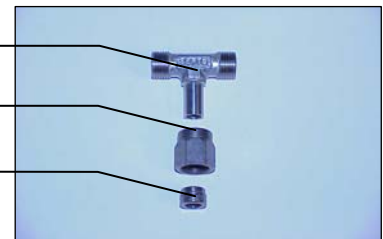

ASSEMBLY INSTRUCTIONS

1. Place nut over bottom of T-Piece.
2. Place clamp ring on next.
3. Tighten nut down on boiler.
4. Clamp ring will automatically tighten down on T-Piece.

IMPORTANT NOTE:

As of January 1, 2004 steam inlet tube assemblies have been upgraded to an all metal 2-piece Steam Inlet Tube (see Figure 1).

- Inlet Tube Steam (63304) is now installed together with the new Inlet Tube Extension (71013) (see Figure 2).
- Use Adapter 8-8 (68209) from Inlet Tube Steam (63304) to connect to the new Inlet Tube Extension (71013) and new, shorter Inlet Tube Teflon (64090).
- On upgraded machines, Inlet Tube Teflon (63462) has been replaced by the new, shorter Inlet Tube Teflon (64090).

Inlet Tube Teflon (63462) should be upgraded to the above.

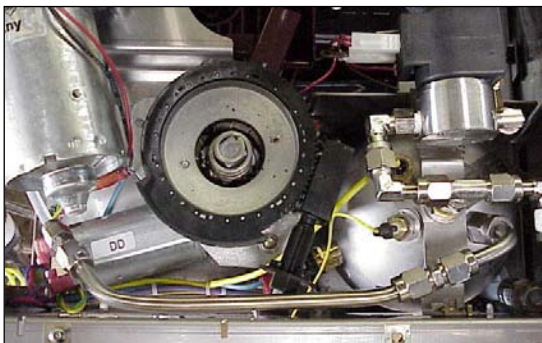
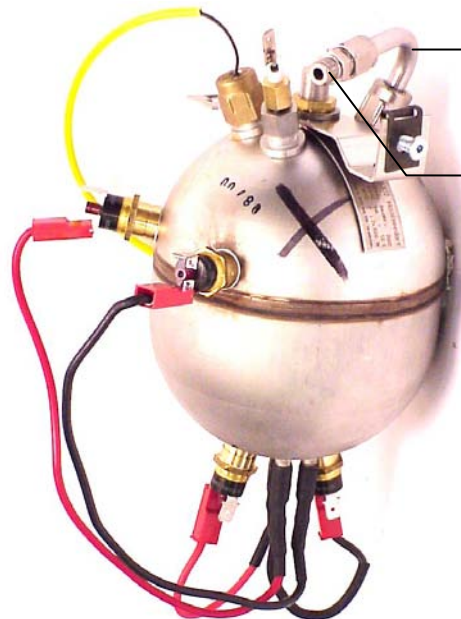

Figure 1



63304 Inlet Tube Steam

68284 Adapter 8-8 (Double Nipple S0-41020-8)

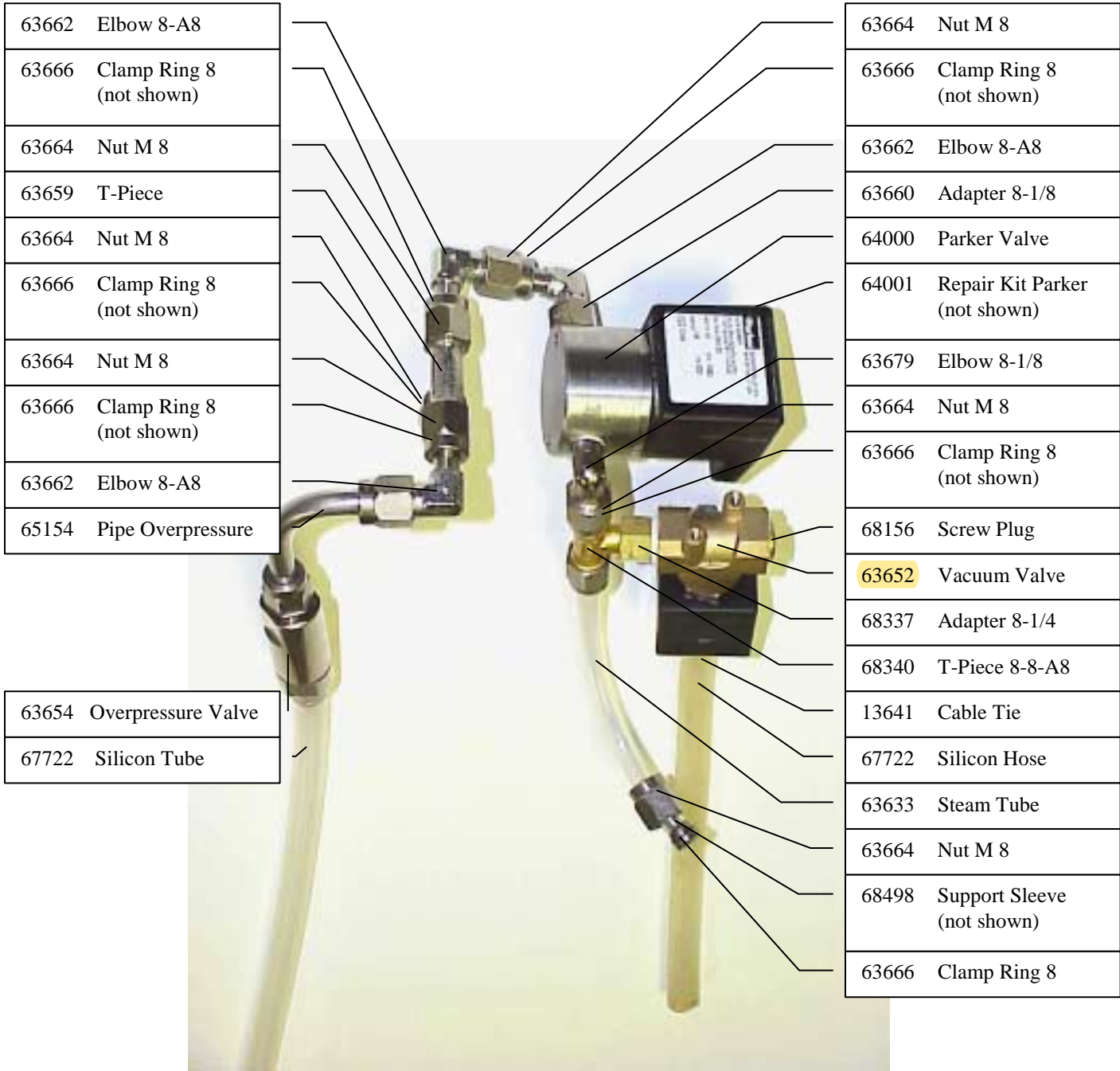

Figure 2

63672	Adapter 8-6 (not shown)
71013	Inlet Tube Steam Extension
68209	Adapter 8-8 (Nipple S0-81020-8CV)
63304	Inlet Tube Steam
64090	Inlet Tube Teflon (New)
63462	Inlet Tube Teflon



65180 Protection Strips (Bulk)



63633	Steam Tube
63677	Elbow 8-1/4
63615	Cable Tie blue
1999010	Hex Screw
63059	Outlet Frame

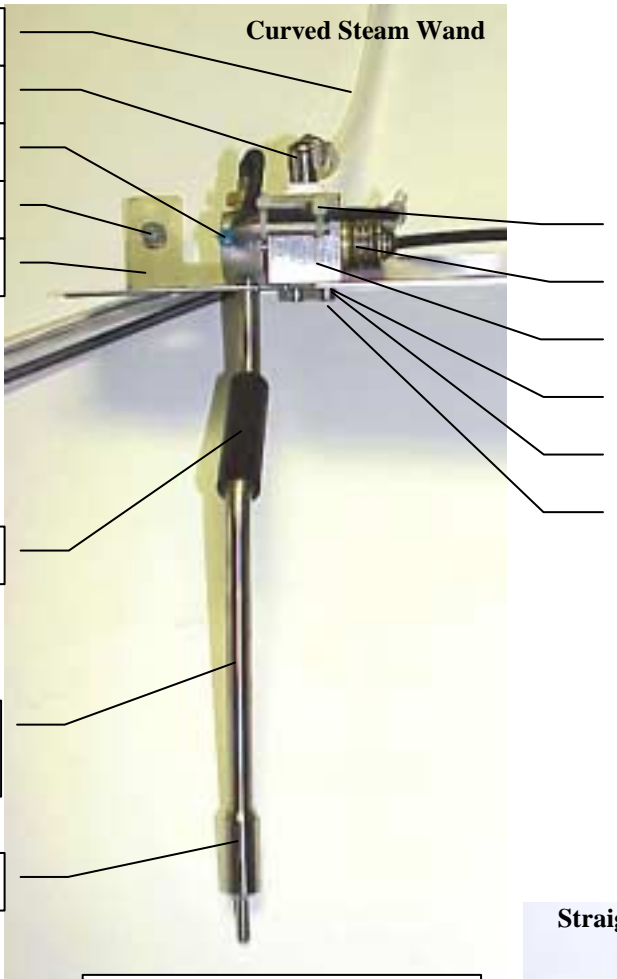

13641	Cable Tie
65226	Seal Set
63629	Wand Support
1064003	Washer
1067007	Lock Washer
1001016	Hex Screw

63601	Protection Tube
-------	-----------------

63622 **Curved Steam Wand Complete**

63632	Steam Tip
-------	-----------

63643	Fitting
63641	Sealing
	Swivel Bearing
61346	O-Ring
61415	Knob
61416	Knob Screw
61343	Handle
61345	Steam Wand Tube
<u>61348</u>	<u>Straight Steam Wand Complete</u>
61346	O-Ring
61344	Steam Tip
61342	Temperature Probe

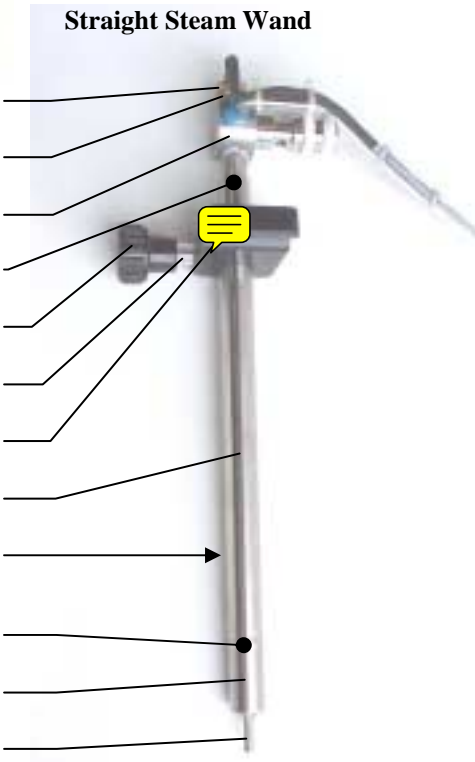

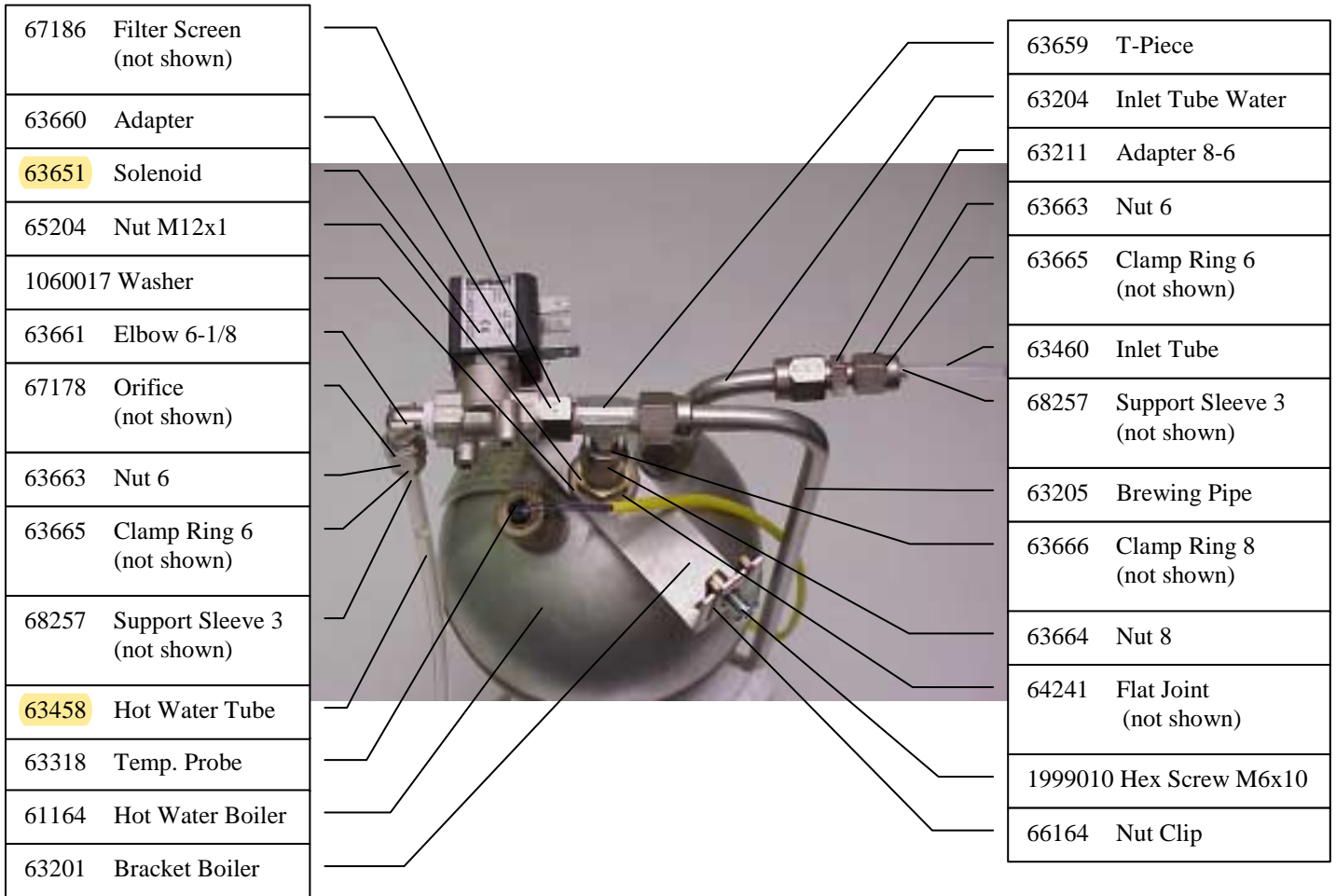

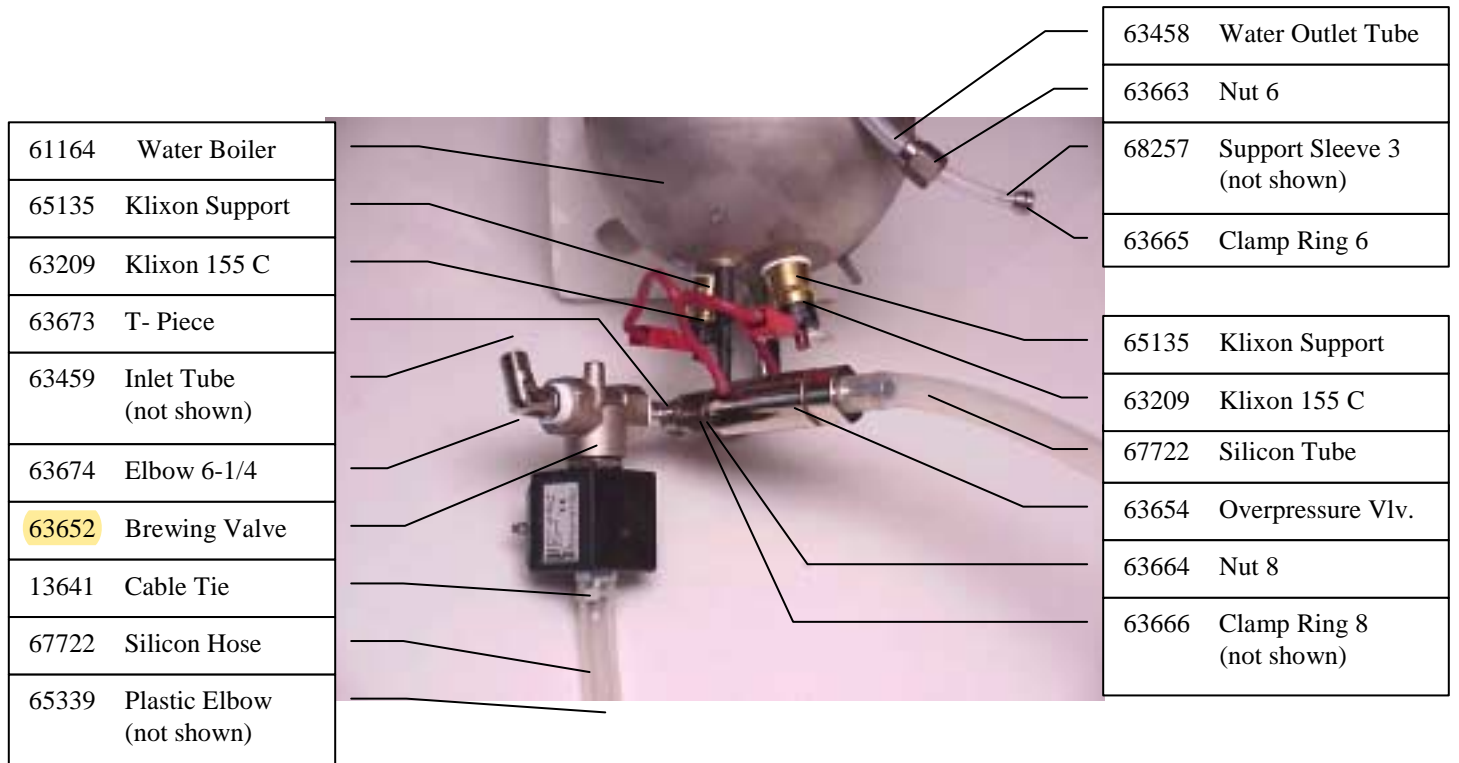

61164	Water Boiler
65135	Klixon Support
63209	Klixon 155 C
63673	T- Piece
63459	Inlet Tube (not shown)
63674	Elbow 6-1/4
63652	Brewing Valve
13641	Cable Tie
67722	Silicon Hose
65339	Plastic Elbow (not shown)

63458	Water Outlet Tube
63663	Nut 6
68257	Support Sleeve 3 (not shown)
63665	Clamp Ring 6
65135	Klixon Support
63209	Klixon 155 C
67722	Silicon Tube
63654	Overpressure Vlv.
63664	Nut 8
63666	Clamp Ring 8 (not shown)

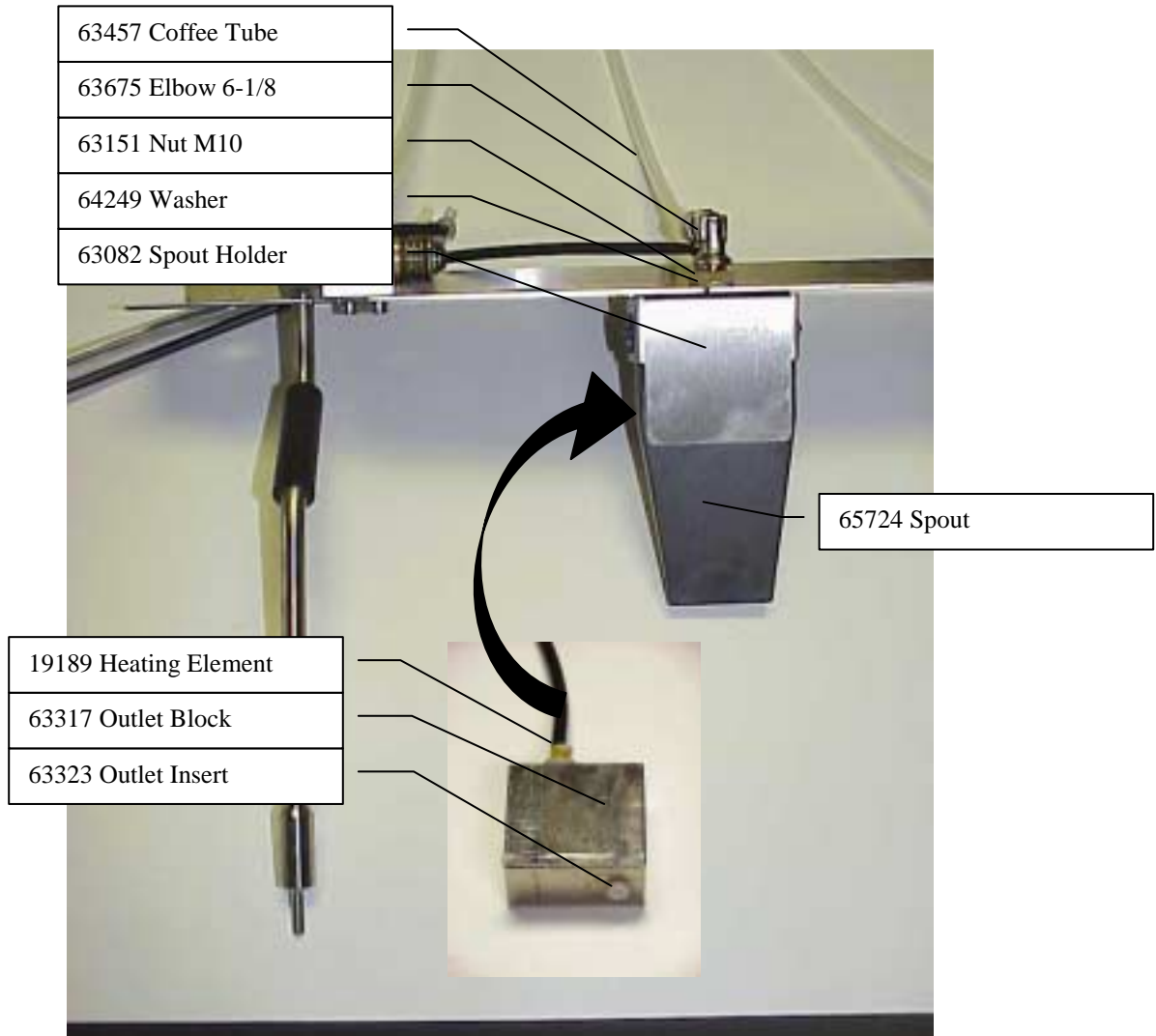

Please note that the heating block is no longer available.
For the replacement or upgrade solution, see page 3.3.1

The outlet heating block is no longer available and can be replaced with the new Teflon nipple.
 Parts needed to convert: (1 ea) 67760 Coffee Tube, (1 ea) 61965 Teflon Nipple and (1 ea) 63151 Nut.

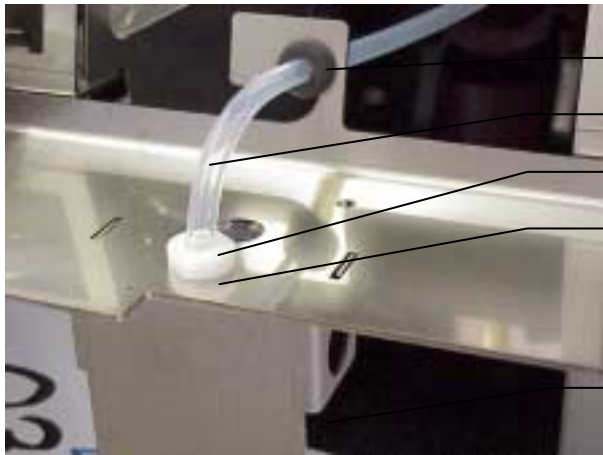

- | | |
|-------|-----------------|
| 63675 | Rubber Grommet |
| 67760 | Coffee Tube |
| 61965 | Teflon Nipple |
| 63151 | Nut (not shown) |
-
- | | |
|-------|-------|
| 65724 | Spout |
|-------|-------|



- | | |
|---------|-----------------------|
| 61660 | Teflon tube hot water |
| 1219002 | Nut (2 times) |
| 61982 | Outlet tube |

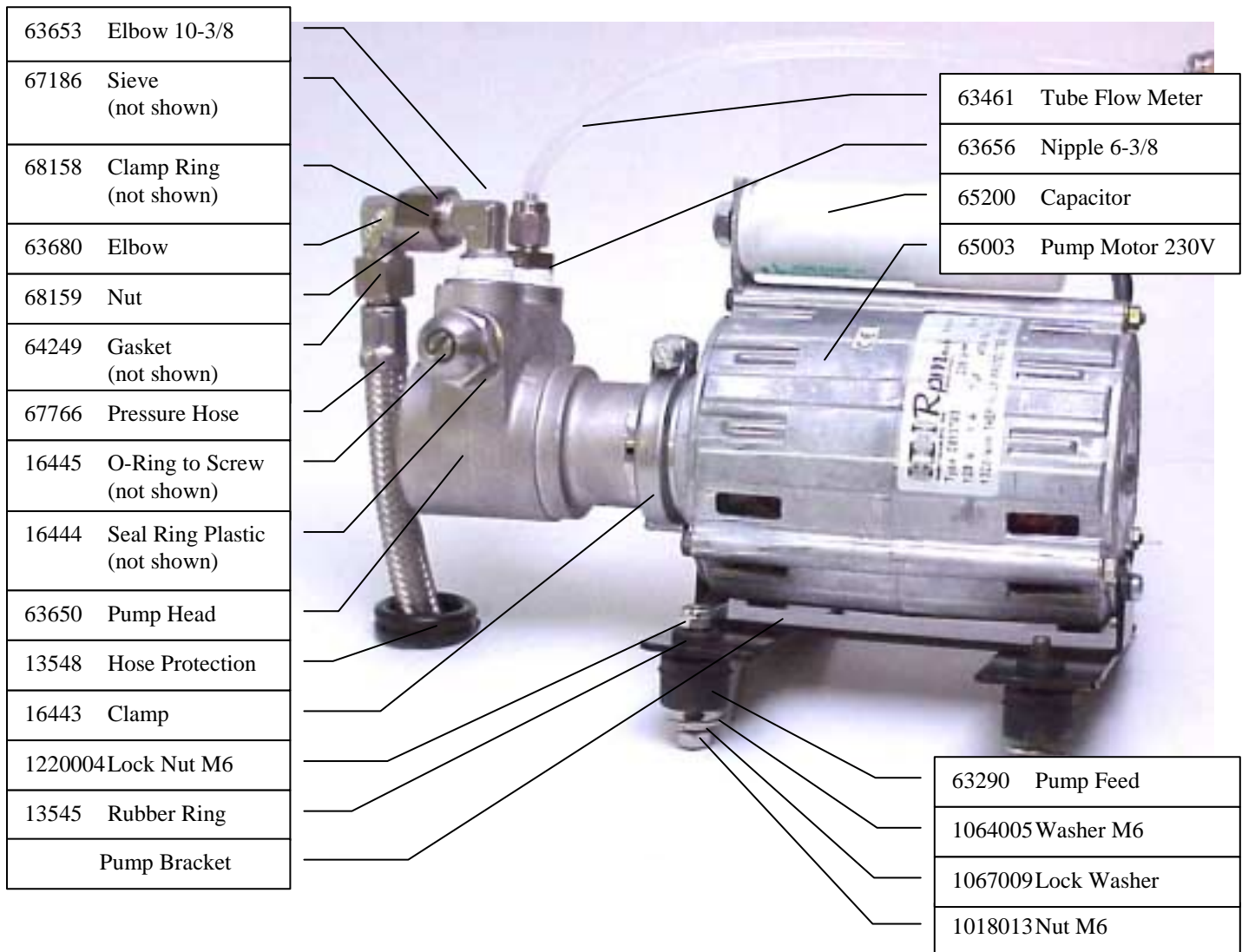

63653	Elbow 10-3/8
67186	Sieve (not shown)
68158	Clamp Ring (not shown)
63680	Elbow
68159	Nut
64249	Gasket (not shown)
67766	Pressure Hose
16445	O-Ring to Screw (not shown)
16444	Seal Ring Plastic (not shown)
63650	Pump Head
13548	Hose Protection
16443	Clamp
1220004	Lock Nut M6
13545	Rubber Ring
	Pump Bracket

63461	Tube Flow Meter
63656	Nipple 6-3/8
65200	Capacitor
65003	Pump Motor 230V

63290	Pump Feed
1064005	Washer M6
1067009	Lock Washer
1018013	Nut M6

63462	Inlet Tube Steam
63460	Inlet Tube Water
68257	Support Sleeve 3 (not shown)
63665	Clamp Ring 6 (not shown)
67178	Orifice (not shown)
63663	Nut 6
63670	T- Piece
63655	Check Valve
63669	Adapter 6-1/4
63657	Elbow
63665	Clamp Ring 6 (not shown)
63663	Nut 6
63671	Male Adapter
61226	Flowmeter

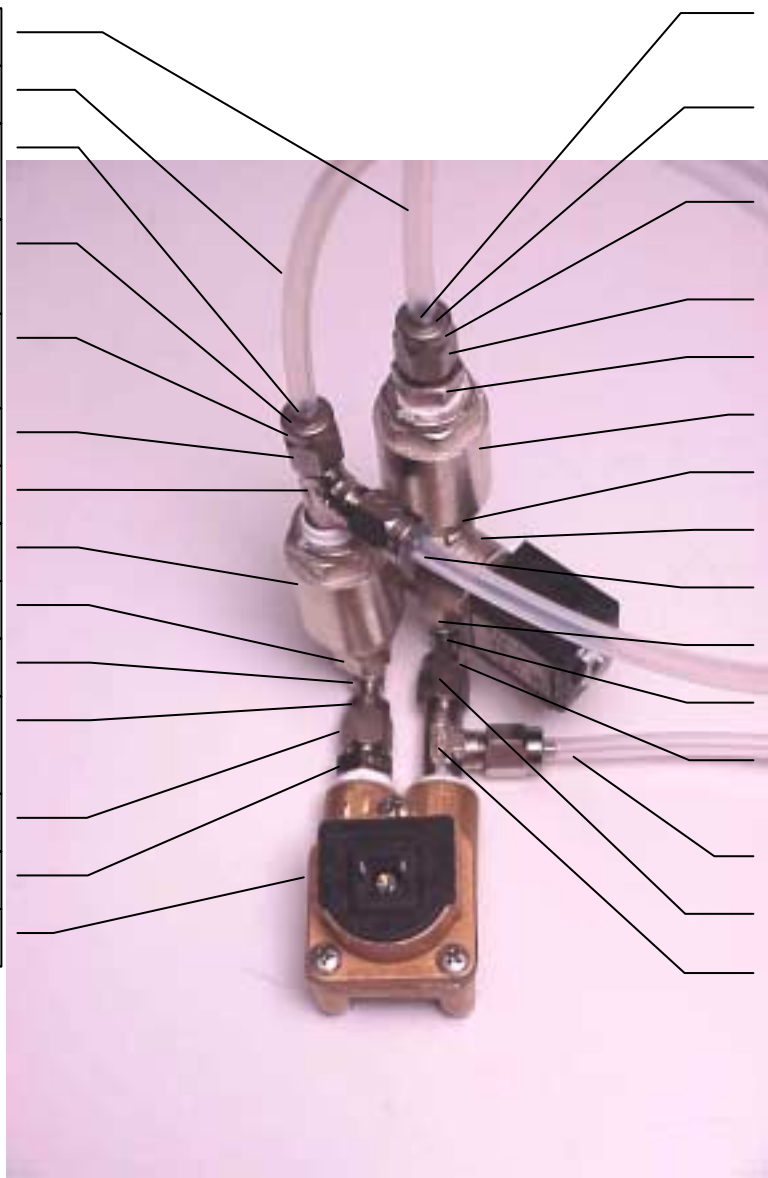

68257	Support Sleeve 3 (not shown)
63665	Clamp Ring 6 (not shown)
67178	Orifice (not shown)
63663	Nut 6
63671	Male Adapter
63655	Check Valve
68206	Male Adapter
63651	Solenoid
63606	Manometer Tube
63658	Adapter
63657	Elbow
63665	Clamp Ring 6 (not shown)
63461	Tube Flowmeter
63663	Nut 6
63670	T-Piece

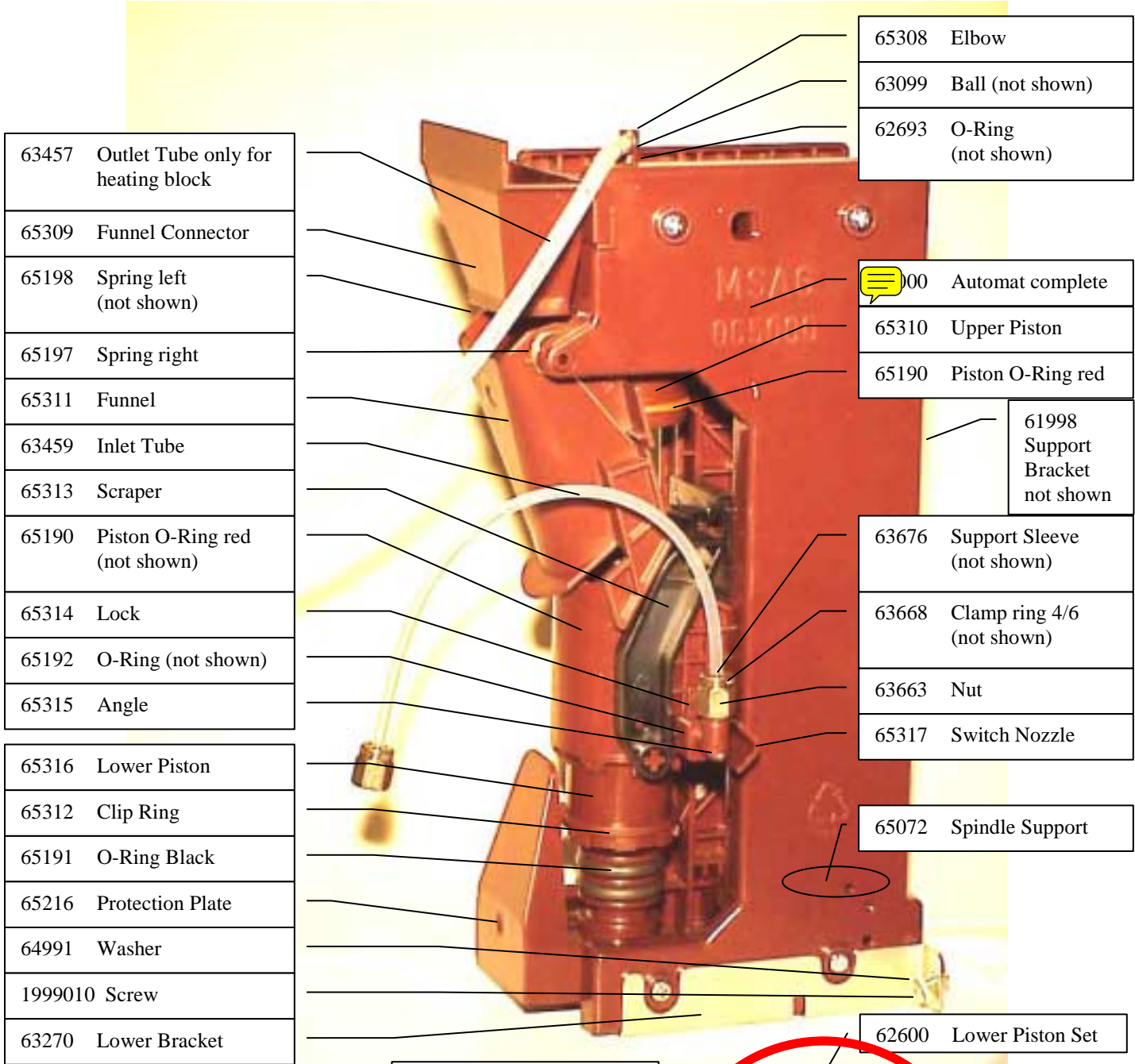

- 63457 Outlet Tube only for heating block
- 65309 Funnel Connector
- 65198 Spring left (not shown)
- 65197 Spring right
- 65311 Funnel
- 63459 Inlet Tube
- 65313 Scraper
- 65190 Piston O-Ring red (not shown)
- 65314 Lock
- 65192 O-Ring (not shown)
- 65315 Angle
- 65316 Lower Piston
- 65312 Clip Ring
- 65191 O-Ring Black
- 65216 Protection Plate
- 64991 Washer
- 1999010 Screw
- 63270 Lower Bracket

- 65308 Elbow
- 63099 Ball (not shown)
- 62693 O-Ring (not shown)

- 000 Automat complete
- 65310 Upper Piston
- 65190 Piston O-Ring red

61998 Support Bracket not shown

63676 Support Sleeve (not shown)

63668 Clamp ring 4/6 (not shown)

63663 Nut

65317 Switch Nozzle

65072 Spindle Support

62600 Lower Piston Set

65331 Lower Piston Set

The lower piston set (62600) is no longer in use. Replace with 65331. Do not mix parts between old and new version of lower piston.



New version: smooth on the inside of lower piston.



Old version: ribbed on the inside of lower piston.

The machine used to be equipped with a 24 Volt motor. We upgraded the Ambiente beginning 2003 and the Verismo 701 end of 2003. Older machine with 24V motor should get a 24V motor as replacement.

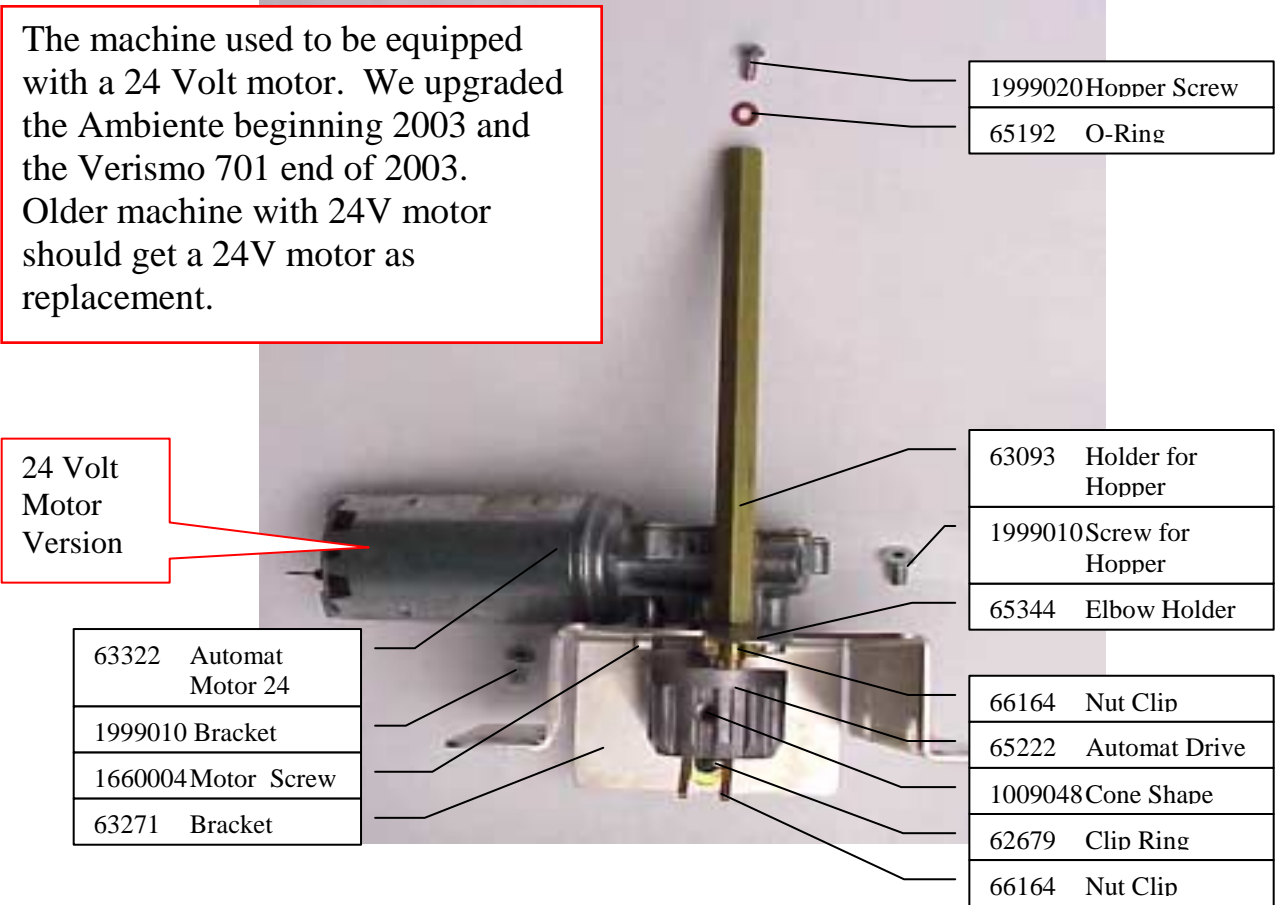

The 36 Volt motor uses the same Bracket. Frame and panel upgrade is required when converting 24V motor to 36V

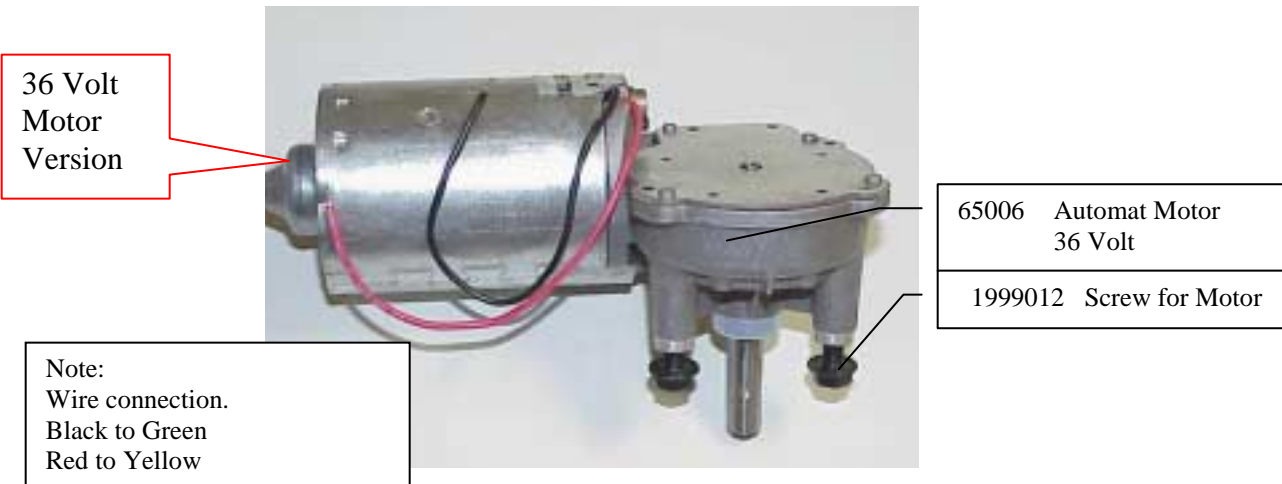

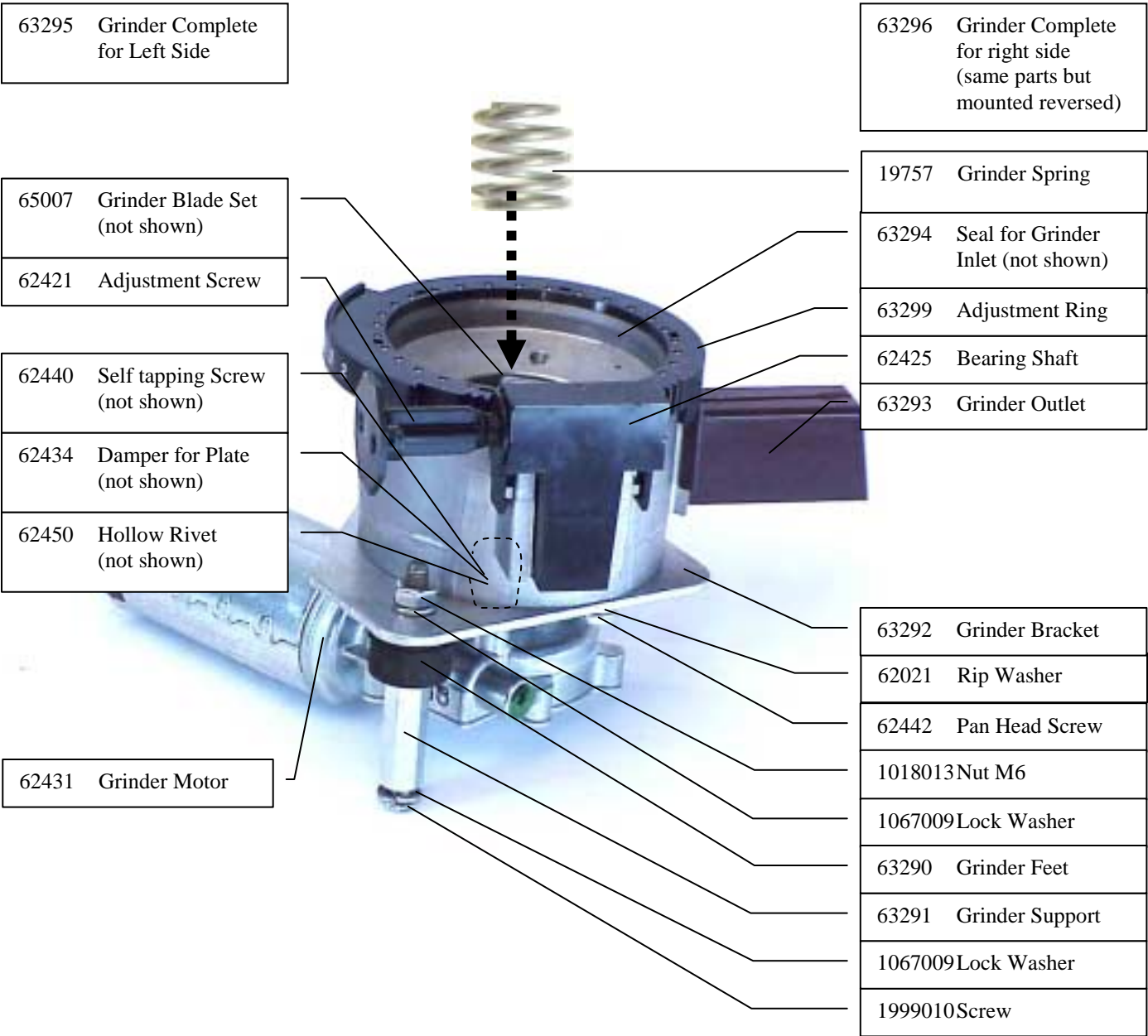

65023	Bean Hopper Lid
63023	Hopper Extension (optional)
1999020	Hopper Screw (not shown)
65192	O-Ring (not shown)
63025	Finger Protection
63005	Decaf Lid
63002	Bean Hopper
63294	Seal for Grinder
50373	Bean Slide

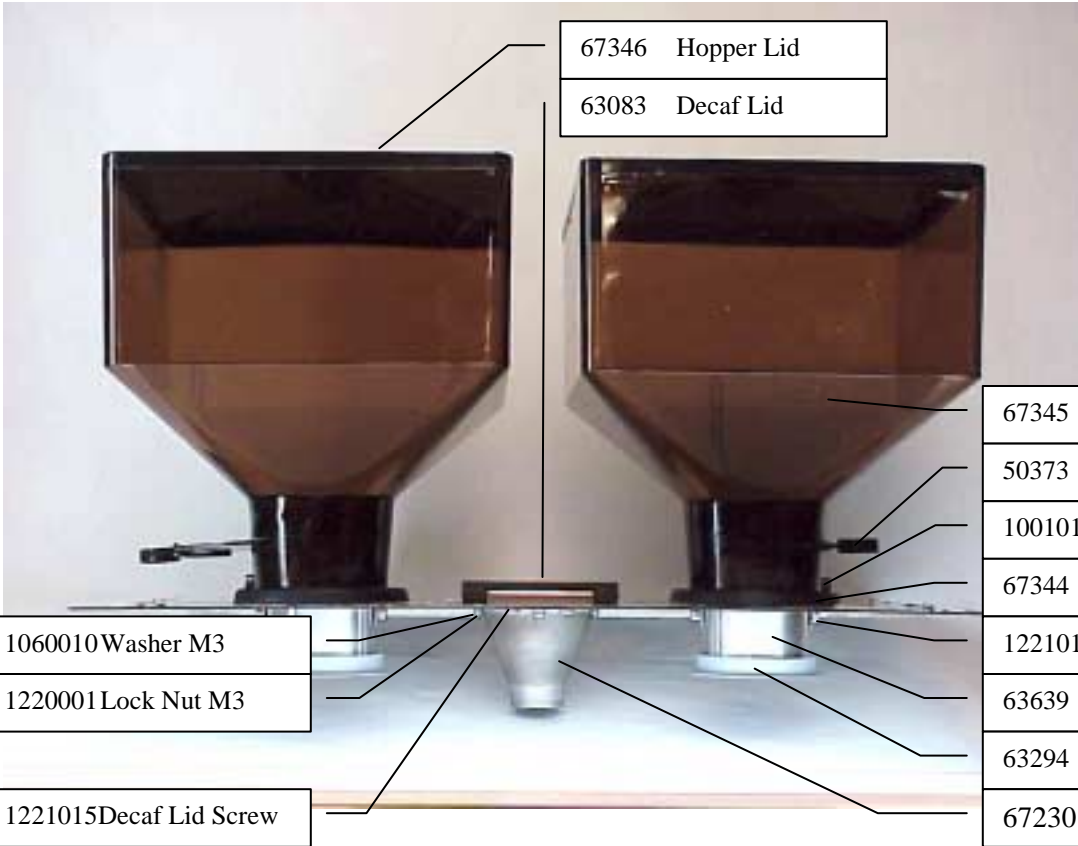
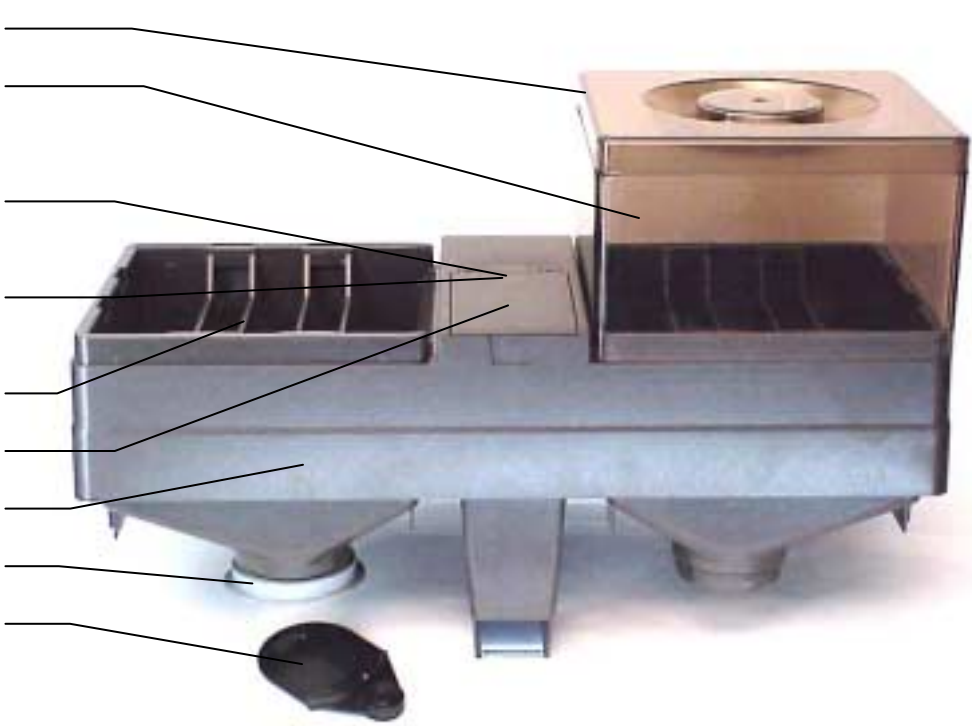

67346	Hopper Lid
63083	Decaf Lid

67345	Bean Hopper
50373	Bean Slide
1001017	Hopper Screw
67344	Hopper Ring
1221015	Screw
63639	Hopper Support
63294	Seal for Grinder
67230	Tablet Funnel

1060010	Washer M3
1220001	Lock Nut M3

1221015	Decaf Lid Screw
---------	-----------------

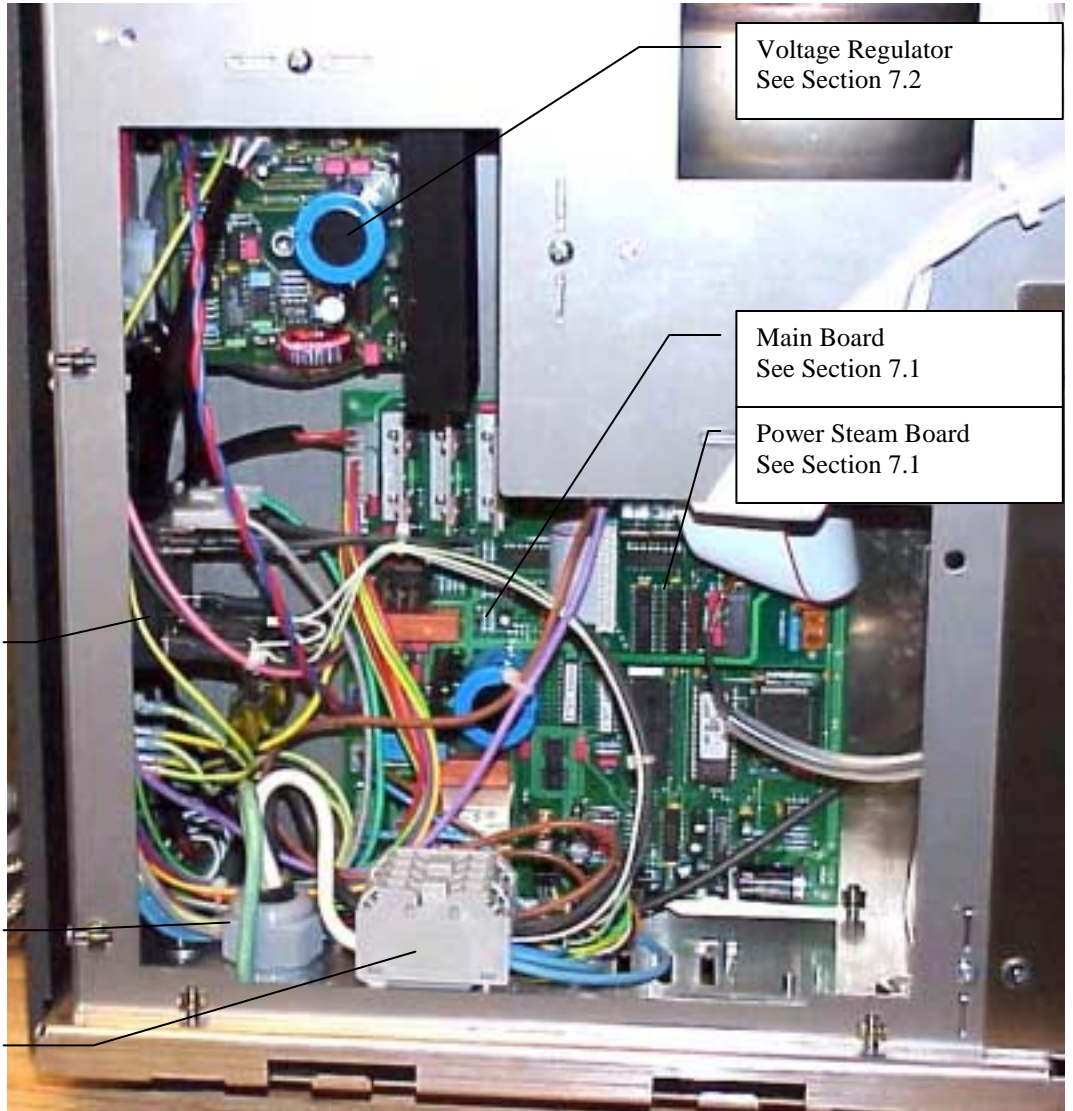

Voltage Regulator
See Section 7.2

Main Board
See Section 7.1

Power Steam Board
See Section 7.1

Heating Relay
See Section 7.3

Power Cord
See Section 7.3

Main Terminal
See Section 7.3

- Spacer for Power Steam Board
- 63370 Relay white
- 63631 Power Steam Board

- 63250 Main Board

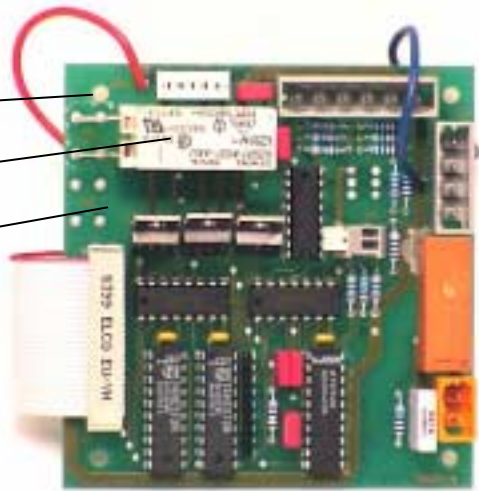

- 65056 8 Amp. Fuse

- 63370 Relay withe

- 26304 2 Amp. Fuse

- 22849 E-Eprom

- 22817 Eprom V2.12 (Program)

- 61289 Battery

- 63256 Spacer (Click on)

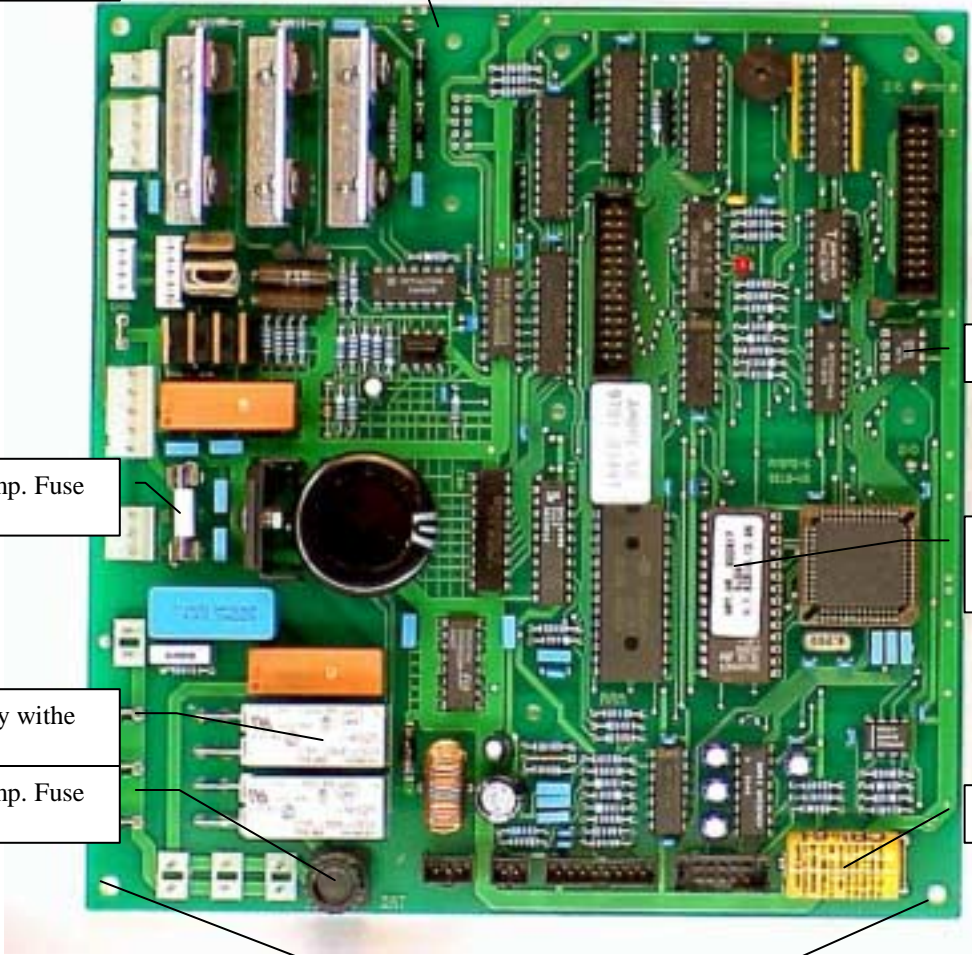

- 63645 Transformer
- 1064005 Washer M6
- 1999010 Screw

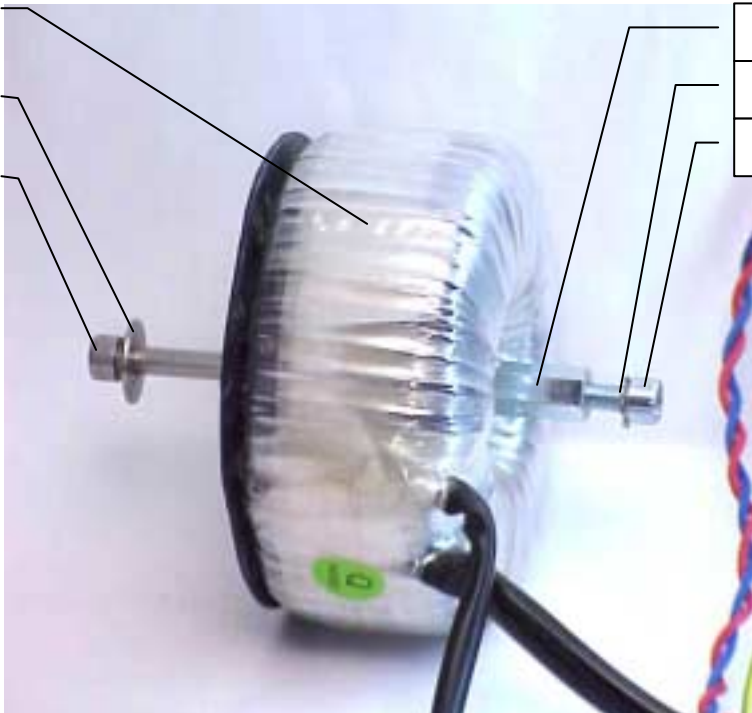

- 63291 Spacer Nut
- 1067009 Lock Washer
- 1999015 Screw

- 65056 8 Amp. Fuse

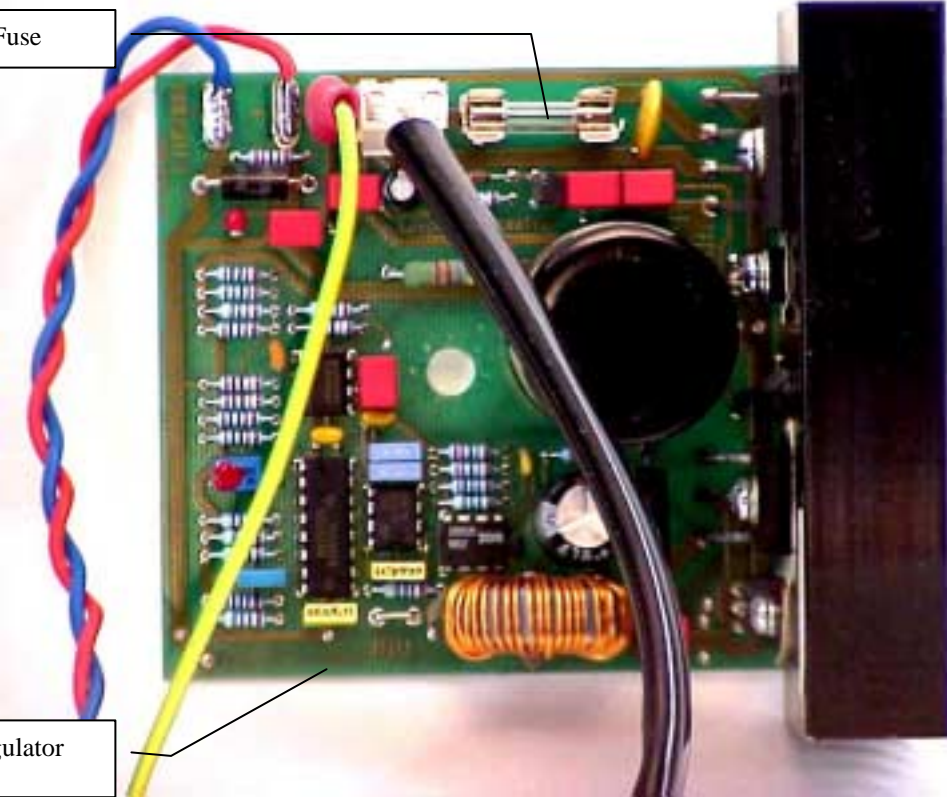

- 63630 Volt Regulator



The control power to the Power relays changed beginning 2003 from 208VAC to 24VDC

- 208 VAC Relay has a large pin (1) and is hooked up to the white Relays on the PC
- 24VDC Relay has a small pin (2) and is hooked up directly to the center of the PC

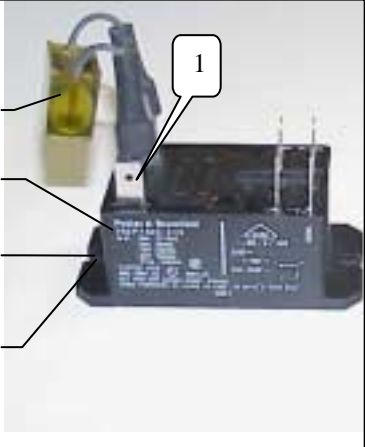
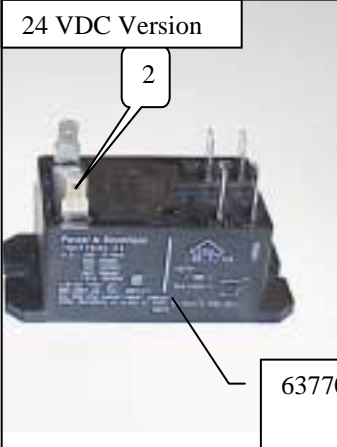
IMPORTANT: 208 VAC and 24 VDC are NOT interchangeable

208 VAC Version		24 VDC Version	
68063 RC-Unit Relay		63770 External Relay with 24VDC Coil	
61025 External Relay with 208 VAC Coil			
1070002 Lock Nut M4 (not shown)			
1001017 Screw			

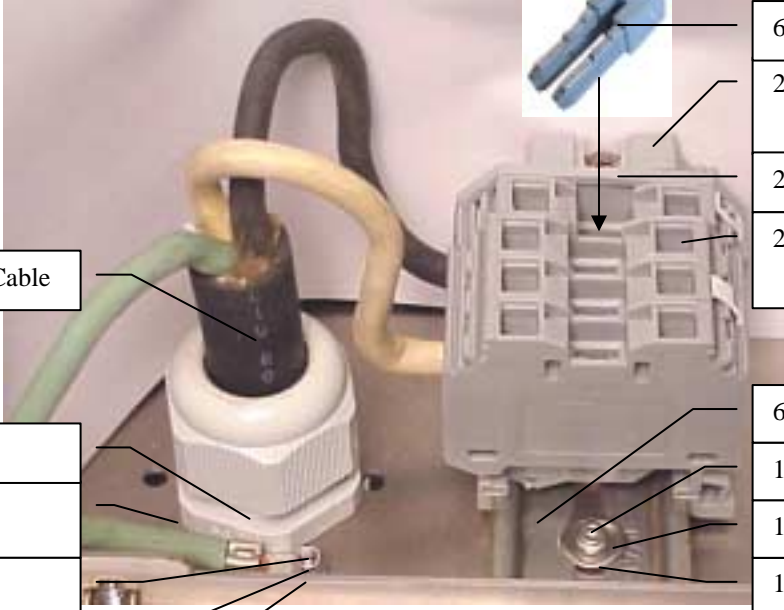
61222 Wire from board to coffee and steam relays

	65570 Main Power Cable	61102 Jumper
		22573 Main Terminal Clamp
		22554 Main Terminal Cap
		22550 Main Terminal (4 each)
13523 Cable Holder		66051 Terminal Support
13528 Holder Nut (not shown)		1001012 Screw M3
1001012 Screw M3		1064003 Washer
1073004 Washer M3		1220001 Lock Nut M3 (not shown)
1220001 Lock Nut (not shown)		

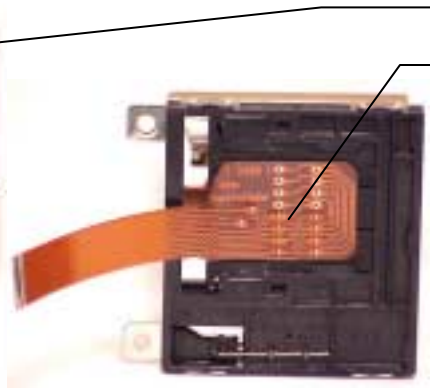
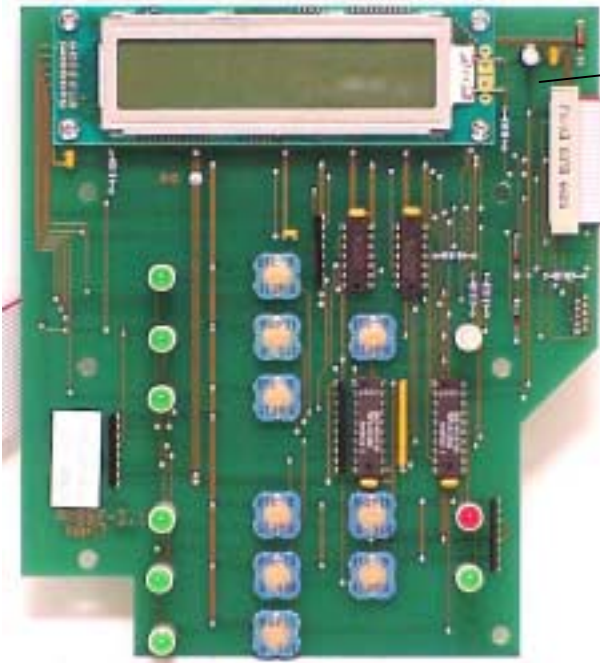

- 63251 Display Board
- 63252 Chip Card Reader

- 63248 Window
- 63000 Front Panel
- 63001 Panel Cover
- 63032 Button Black
- 63198 Button Cap

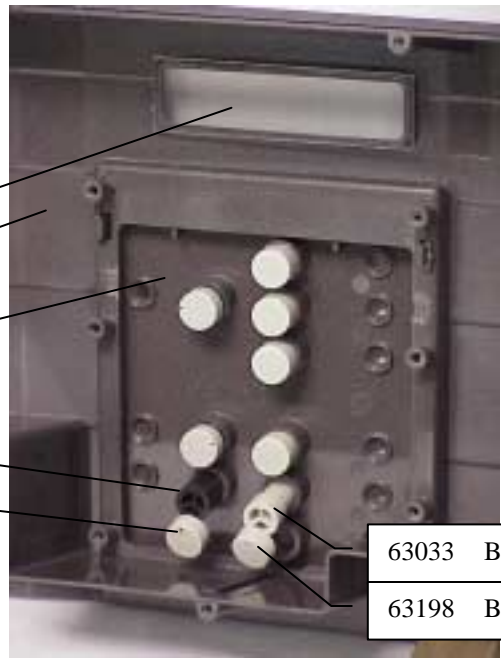

- 63033 Button White
- 63198 Button Cap

- 13552 Hose Protection
- 1220004 Lock Nut M6
- 63089 Front Panel Holder
- 1001050 Socket Head Screw
- 63074 Panel Back Plate
- 1685002 Front Panel Screw

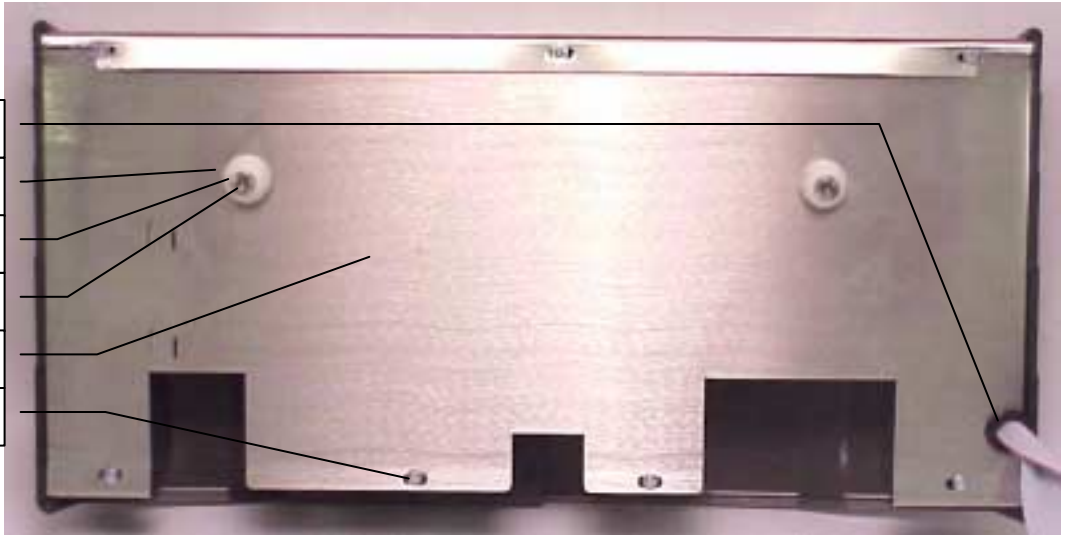

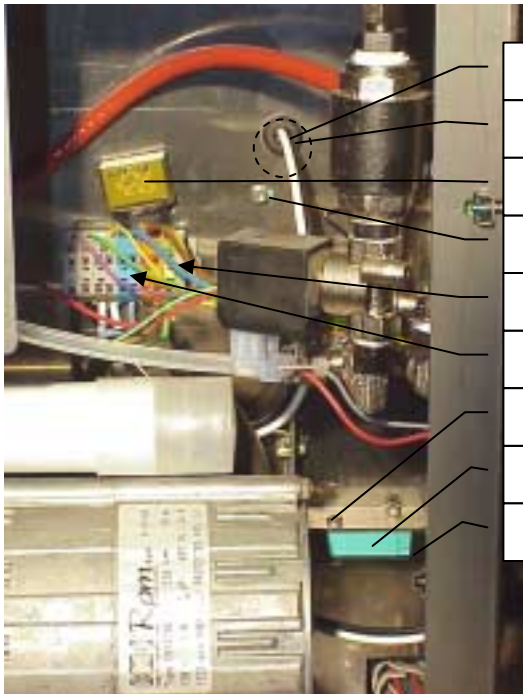

- 63199 Switch Cover
- 65027 Micro Switch
- 65304 RC-Unit
- 1001014 Screw M3x14
- 22619 End Cap
- 22617 Terminal
- 1001014 Screw M3x14
- 65027 Micro Switch
- 63199 Switch Cover



63267 Wire Tree to Decaf Grinder

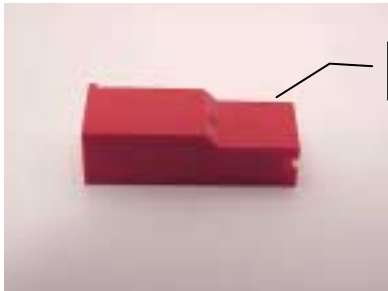

65246 Cover for Plug



63571 Wire for Bypass

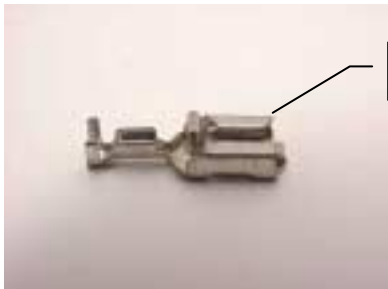

65258 Heating Plug



22853 Eprom for non Power Steam



63353 Discharge Tube



63930 Chef Card

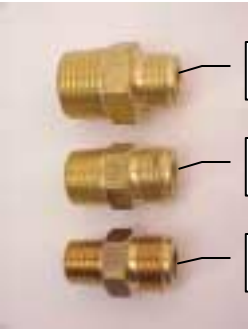

68179 Nipple 10 - 1/2

68178 Nipple 10 - 3/8

68501 Nipple 10 - 1/4

61111 Save Data Card

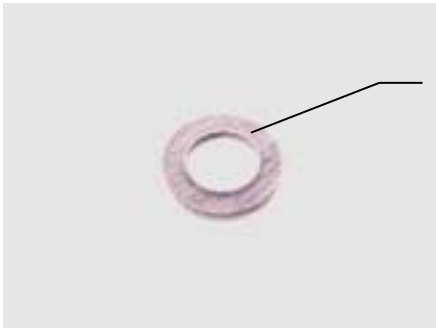

64249 Gasket



63939 Cup Card



65221 Cleaning Tablets

63935 Service Card



67409 Cleaning Brush

50373 Bean Slide





65320 Hex Key Spec.

63911 Manometer Tool



65321 Hex key Long

63996 Foot Extension



62985 Turn Knob

67399 Food Grease



65303 Grease for Automat

67391 Thermal Paste



67445 Schaerer Spray



67449 CPM Cleaning Liquid





65180 Wire Protection (Bulk)

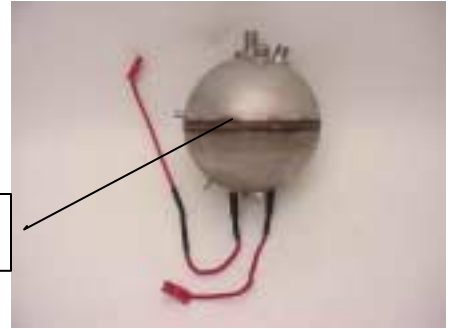

65110 Steam Boiler 3 Kw

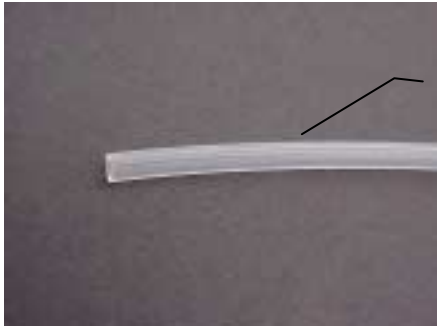

63276 Teflon Tube 4-2.5mm (Bulk)



1220002 Lock Nut M4



67759 Teflon Tube 6-3mm (Bulk)



1042044 Screw M4x16



CFS 6135-C Cuno Complete



SWC-1350 C Cuno Cartridge



20-059-P John Guess Fitting

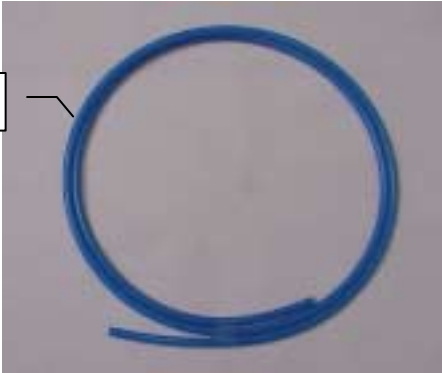

PE64-100-B Blue Tubing

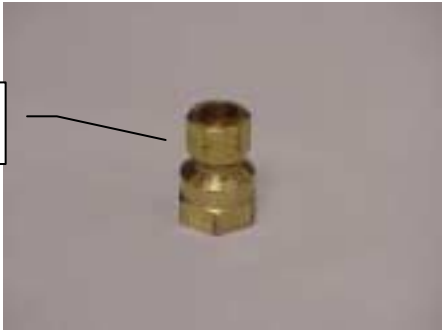

SSE 00491 3/8" Captive Compression Unit

