



**Operator's Manual**  
*Cream whipper model CW 5*

INTRODUCTION



This manual is divided into the following six sections:

## INTRODUCTION

A	Parts of the Machine	5
B	Specifications	5

## UTILIZATION

A	Parts of the Machine	5
B	Specifications	5
C	Machine's operation:	6

## OPERATION

C	Machine's operation:	
	Setting dispensing time	
	IMPORTANT RULES	6 - 7
D	Rinsing Phase:	8
E	Disassembling Primary Parts:	8 - 9
F	Disassembling Secondary Parts:	9 - 10
G	Cleaning Disassembled Parts:	10
H	Cleaning Machine:	11
L	Assembling Secondary Parts of the Machine:	11 - 12
M	Assembling Primary Parts of the Machine:	13 - 14

## MAINTENANCE

N	Sanitizing:	14 - 15
P	Replacing the gaskets	16
Q	General alarm indications displayed on the control panel – causes and solutions	18

## TROUBLESHOOTING

R	Troubleshooting – flowchart	19
---	-----------------------------	----

## PARTS

S	Replacement Parts:	24
---	--------------------	----

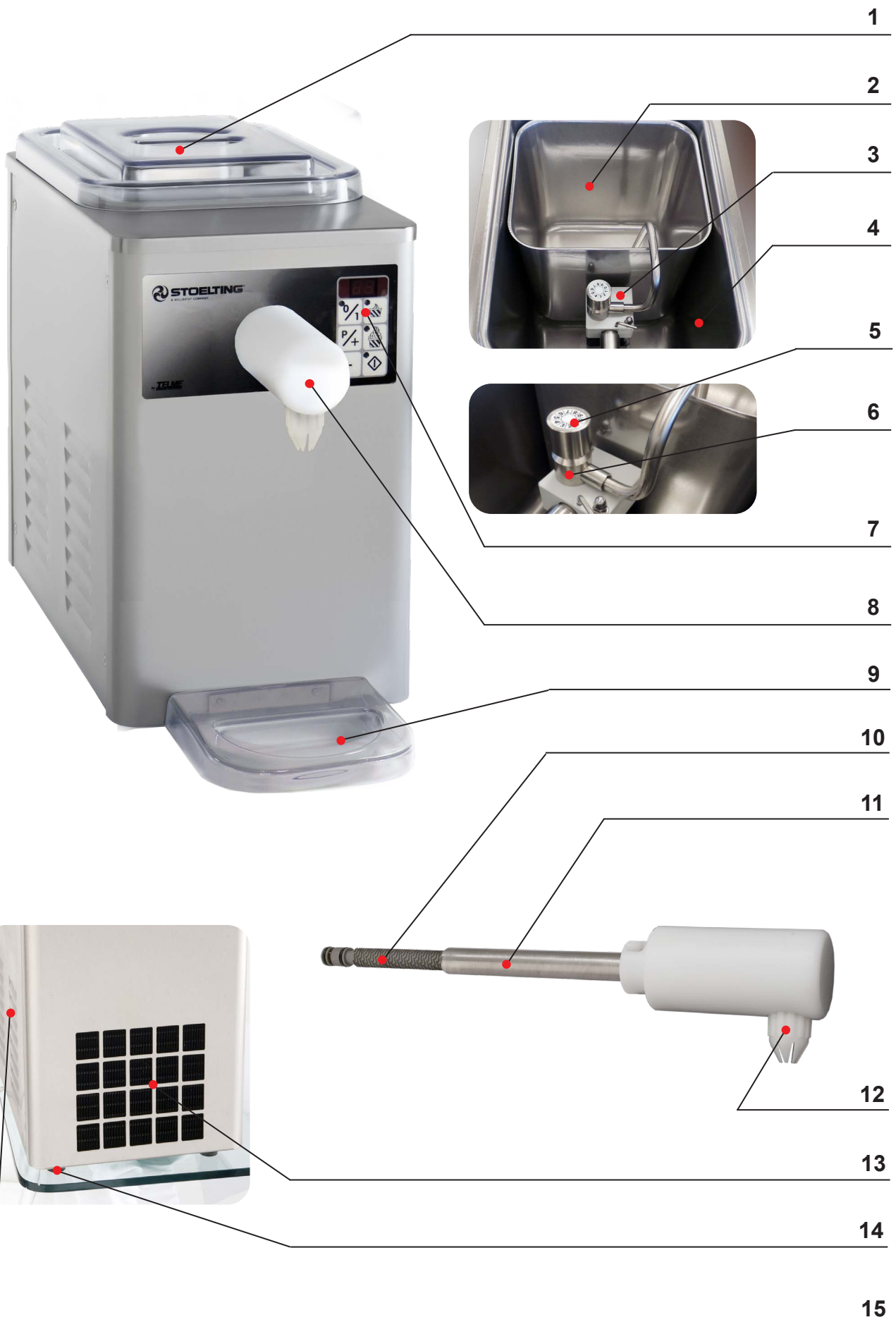

## A Parts of the Machine

- |                                  |                      |
|----------------------------------|----------------------|
| 1. Lid                           | 9. Drip tray         |
| 2. Cream Container               | 10. Labyrinth        |
| 3. Pump                          | 11. Labyrinth-tube   |
| 4. Refrigeration tank            | 12. Nozzle           |
| 5. Air Regulator Adjustment Knob | 13. Condenser outlet |
| 6. Air regulator                 | 14. Support feet     |
| 7. Control panel                 | 15. Outer panels     |
| 8. Dispensing faucet             |                      |

## B Specifications

Model	CW 5	
Net weight	lbs / kg	70 / 32
Dimensions	width / height / depth	10" (25cm) / 18" (46cm) / 18 1/2" (47cm)
Hopper Volume (max)	gal / L	1,32 / 5
Max. ambient temperature	°F / °C	95 / +35
Compressor	Number / Btu/hr	1 / 290
Coolant gas	(type)	R134a
air version (quantity)	g / oz	160 / 5,64
AIR version: (coolant gas pressure)	bar	9,8 ÷ 10,3
"CONDENSATION" (coolant gas temperature)	°C / °F	+42 ÷ +45 / 107,6 ÷ 113
AIR version: (coolant gas pressure)	bar	0,2 ÷ 0,1
"EVAPORATION" (coolant gas temperature)	°C / °F	-22 ÷ -25 / -7,6 ÷ -13
Drive motor	Number / hp	1 / 0,41
Rated power	kW	0,5
Rated current	A	8
Power supply	Voltage (Volts)	115
	Frequency (Hz)	60
	Phases (PH)	1
Plumbing Fittings		-

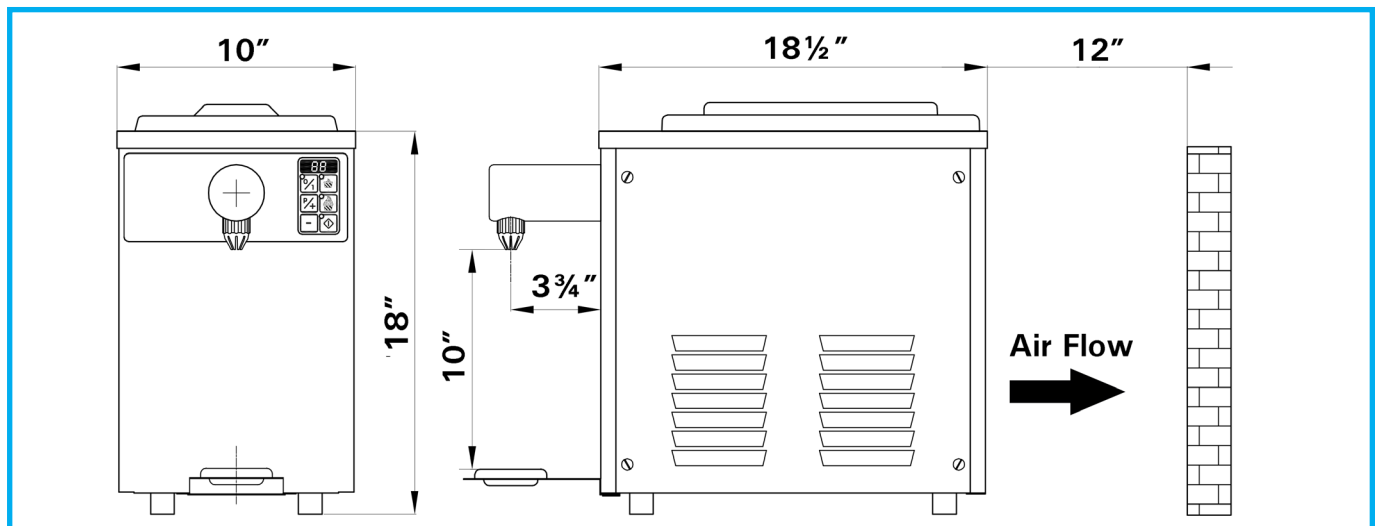

## C Machine's operation:

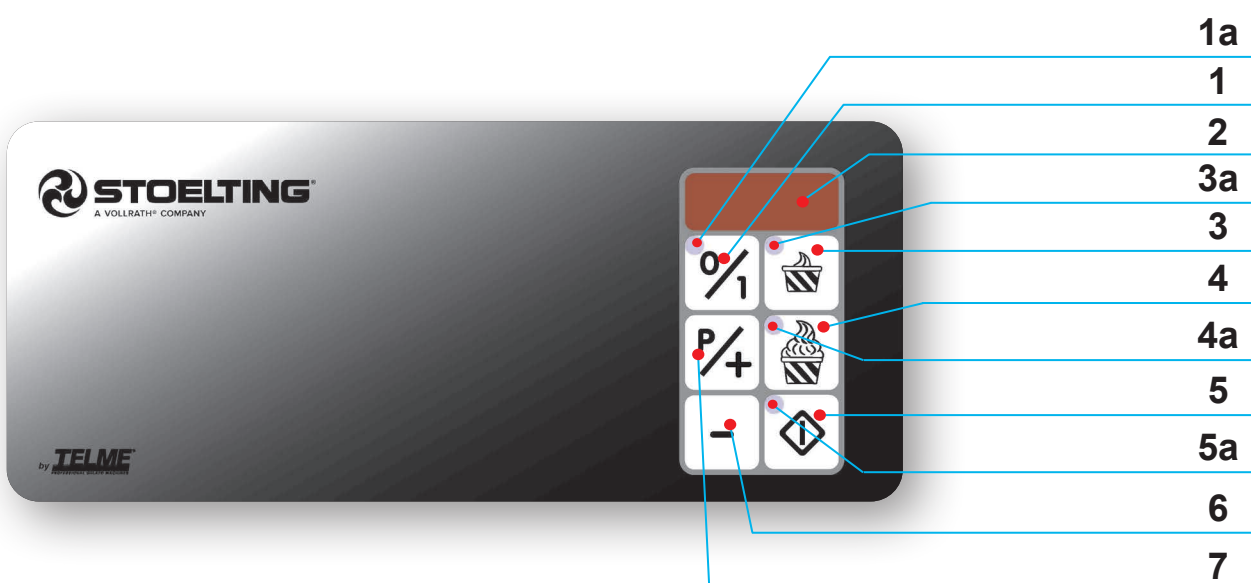

**1. ON/OFF button** For switching the machine on and off. Press to prepare the machine to operate and subsequently the tank temperature is displayed on the digital display (2).

**1a. Power LED** Light indicates that the machine is powered up. When lit the LED indicates that the machine is supplied with electricity.

**2. Digital display** Displays the functions and data set.

**3. "P1 Dispensing" button** Time dispensing button. The factory set value is 7 corresponding to about 1 oz. By pushing the button "7", after P1 parameter, it is possible to set a value between 1 and 90 for the automatic dispensing of the whipped cream. The setting of value 1 corresponds to a 0,5 sec. dispensing, up to a maximum value of 90, which corresponds to a 45 sec. dispensing. When the button is active, its signal led (3a) is on.

**4. "P2 Dispensing" button** Time dispensing button. The factory set value is 21 corresponding to about 3 oz. By pushing the button "7", after P2 parameter, it is possible to set a value between 1 and 90 for the automatic dispensing of the whipped cream. The setting of value 1 corresponds to a 0,5 sec. dispensing, up to a maximum value of 90, which corresponds to a 45 sec. dispensing. When the button is active, its signal led (3a) is on.

**5. "P3 Dispensing" button** Button for the dispensing of the whipped cream:

- Manual, if the "PU" parameter has been set in "P3" programming. The dispensing will go on until the "P3 Dispensing" button is released.
- Continuous, if the "CO" parameter has been set in "P3" programming. The dispensing will go on up to the following pressing of the "P3 Dispensing" button. When the button is active, its signal led (5a) is on.

**6. "Adjustment - Button"** This button is active only during the programming functions, its pushing allows the decrease of the selected value.

**7. "Programming/Adjustment +" Button** *Dual function button:*

- the adjustment parameters (P1, P2, P3,P4) as well as the corresponding set values are viewed in sequence on the digital display by pressing the button for some seconds;
- in the programming function the set value can be increased by pressing the button.

**IMPORTANT RULES**

**NEVER:**

- ! **ADDING SUGAR IN CRISTALS, ONLY LIQUID SUGAR.**
- ! **DISASSEMBLE THE PUMP FOR CLEANING.**
- ! **DO NOT RUN THE PUMP WITHOUT SOLUTION / SANITIZER IN ORDER TO AVOID TO DAMAGE IT.**

**Setting dispensing time**

**DURING ITS FACTORY INSPECTION, THE MACHINE HAS BEEN PROGRAMMED WITH OPTIMAL VALUES FOR THE OPERATION.**

**IF PARAMETER VALUES DO NEED TO BE ALTERED, MAKE ANY NECESSARY MACHINE PROGRAMMING CHANGES BEFORE STARTING PRODUCTION.**

Keep the PROGRAMMING/ADJUSTMENT + (7) button pressed for a few seconds to access the programming functions and change the type of dispensing.

The operation set at the factory proceeds as follows:

**Code            Function**

- P1**            Having pressed the PROGRAMMING/ADJUSTMENT + button (7), the P1 code flashes on the digital display. Some seconds later, a numerical value indicating the dispensing time set appears automatically on the digital display. Press adjustment buttons (6) and (7) to increase or reduce the dispensing time value. The time can be adjusted within a range of 1 to 90. The setting of value 1 corresponds to a 0,5 sec. dispensing, up to a maximum value of 90, which corresponds to a 45 sec. dispensing. **The factory set value is 7 = about 1 oz.**
  
- P2**            Having pressed the PROGRAMMING/ADJUSTMENT + button (7), the P2 code flashes on the digital display. Some seconds later, a numerical value indicating the dispensing time set appears automatically on the digital display. Press adjustment buttons (6) and (7) to increase or reduce the dispensing time value. The time can be adjusted within a range of 1 to 90. The setting of value 1 corresponds to a 0,5 sec. dispensing, up to a maximum value of 90, which corresponds to a 45 sec. dispensing. **The factory set value is 21= about 3 oz.**

**Setting Air Regulator**

- Rotate knob clockwise until the air regulator is closed (position 0).



- Rotate knob counterclockwise to necessary value. Standard position is between 2 - 3.



- For normal use do not rotate the knob exceeding position 5.

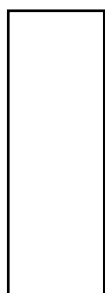

## D Rinsing Phase:

Having pressed the PROGRAMMING / ADJUSTMENT + button , the P3 code flashes on the digital display.

**Setting the continuous dispensing (Co). Maintain the dispensing active until the washing solution cream contained in the cream container is used up.**

- (D1) Pour drinking water at ambient temperature into the cream container up to half of its capacity.
- (D2) Place a suitable container under the dispensing faucet .
- (D3) Press the “DISPENSING” button to drain the rinsing water in the cream container into the appropriate container placed under the dispensing faucet .
- (D4) Press the “DISPENSING” button again to stop the continuous functioning.



## E Disassembling Primary Parts:

**Disassembling of the suction pipe and of the air regulator of the pressurization pump.**

- (E1) Remove the lid on the refrigeration tank.
- (E2) Remove the suction pipe.
- (E3) Turn the air-regulating knob counterclockwise and remove it vertically.
- (E4) Pull the valve holder out vertically.
- (E5) Pull the air regulator out vertically from the pump assembly.

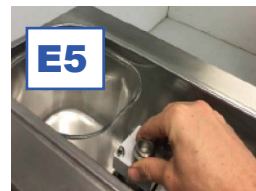
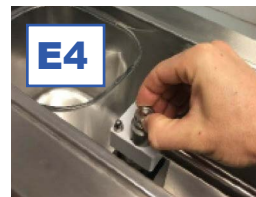
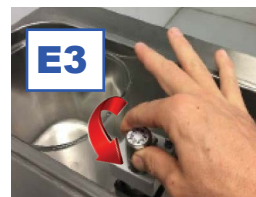

## E Disassembling Primary Parts:

**Disassembling of the dispensing faucet, of the labyrinth and of the cream container.**

- (E6) Remove the fixing rod of the labyrinth from the pump cover.



- (E7) Turn the dispensing faucet clockwise 45° and pull it out of the machine.



- (E8) Remove the labyrinth from the machine



- (E9) Remove the cream container vertically.



## F Disassembling Secondary Parts:

**Disassembling of the nozzle, valve assembly, O-Rings gaskets of the suction pipe and air regulator.**

- (F1) Remove the labyrinth-tube from the dispensing faucet.

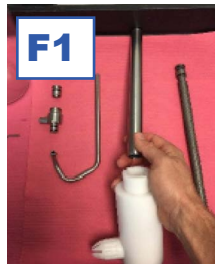

- (F2) Remove the nozzle from the cream dispenser turning it counterclockwise.



- (F3) Take out the regulating valve from the valve-holder.

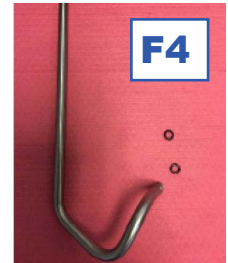
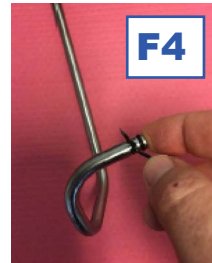

- (F4) Remove the gaskets on the suction pipe using a non-metallic pointy tool, taking care of not damaging the gasket seating.

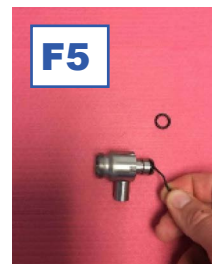

## F Disassembling Secondary Parts:

Removing of the O-Ring gaskets of the labyrinth, of the valve assembly and of the air regulator seating.

- (F6) Remove the gaskets on the labyrinth, using a non-metallic pointy tool, taking care of not damaging the gasket seating.

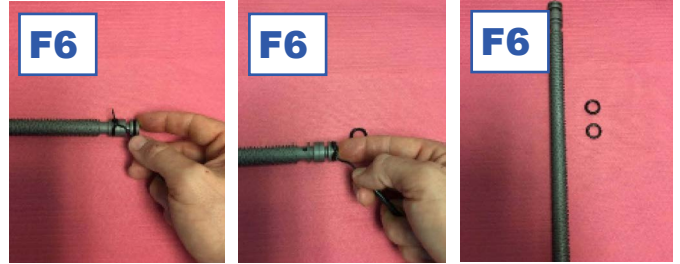

- (F7) Remove the gaskets on the valve assembly.

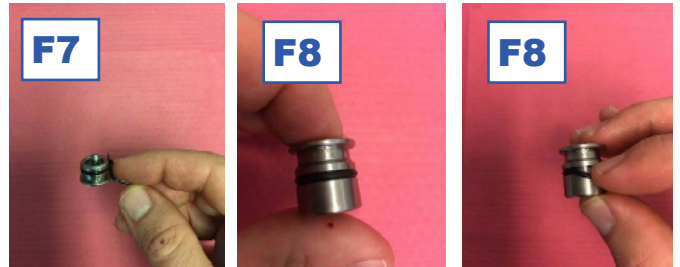

- (F8) remove the gaskets on the air regulator seating, using a non-metallic pointy tool, taking care of not damaging the gaskets' seatings.

## G Cleaning Disassembled Parts:

Disassembled parts require complete cleaning, sanitizing and air drying before assembling. Local and state health codes will dictate the procedure required. Some state health codes require a four sink process (pre-wash, wash, rinse, sanitize, air dry), while others require a three sink process (without the pre wash step). The following procedures are a general guideline only. Consult your local and state health codes for the procedures required in your location.

**Be sure to use the brushes that shipped with the machine to properly clean the parts.**

- (G1) Place all parts in 90° to 110°F (32°C to 43°C) mild detergent water and wash thoroughly. Use the brushes that shipped with the machine to clean all holes of the the removed parts (air-valve, labyrinth, labyrinth-tube, air regulator's body, valve socket, etc.).



- (G2) Rinse all parts with clean 90° to 110°F (32°C to 43°C) water.



- (G3) Then place all parts in a sanitizing solution for at least 1 minute, then remove and let air dry completely before assembling in machine.



## H Cleaning Machine:

- (H1) Using a detergent solution and the small barrel brush provided, clean the holes of the body pump by dipping the brush in the solution and brushing the inside of the holes.



- The exterior of the machine should be kept clean at all times to preserve the luster of the stainless steel. A high grade of stainless steel has been used on the machine to ease cleanup. To remove spilled or dried mix, wash the exterior with 90° to 110°F (32°C to 43°C) mild detergent water and wipe dry.



**Do not use highly abrasive materials, as they will mar the finish. A mild alkaline cleaner is recommended. Use a soft cloth or sponge to apply the cleaner. For best results, wipe with the grain of the steel.**

OPERATION

## L Assembling Secondary Parts of the Machine:

**Note: When dismantling parts for washing, regularly check that gaskets [G] are intact and replace them if damaged or dilated. Use only genuine gaskets, made of food-compatible rubber. Lubricate new gaskets with food compatible grease and fit them on.**

When finished with the washing, all machine components need to be reassembled as follows:

- Reassembling of the cream dispenser and nozzle

- (L1) Place the gasket on the cream dispenser.
- (L2) Turn clockwise the cream dispenser onto the dispensing tap by means of the fixing rod of the labyrinth .
- (L3) Turn clockwise the nozzle onto the cream dispenser.

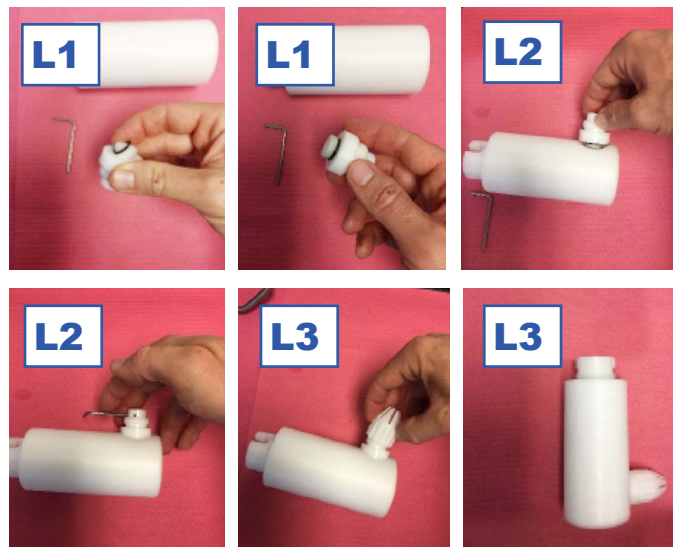

## L Assembling Secondary Parts of the Machine:

**Note:** When dismantling parts for washing, regularly check that gaskets [G] are intact and replace them if damaged or dilated. Use only genuine gaskets, made of food-compatible rubber. Lubricate new gaskets with food compatible grease and fit them on.

• Reassembling of the tube of the labyrinth .

- (L4) Insert the tube in the dispensing faucet.



• Reassembling of the sucking tube connection.

- (L5) Insert the 2 O-Ring gaskets on the sucking tube connection body.

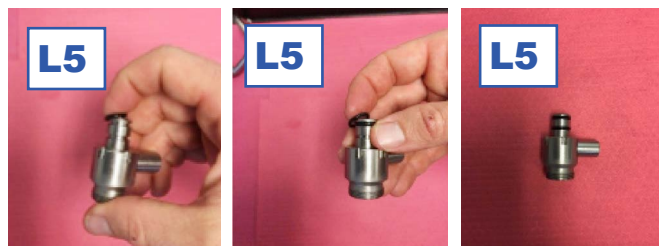

• Reassembling of the air regulator.

- (L5) Insert the O-Ring gasket on the valve kit.

- (L6) Insert the 2 gaskets on the air regulator holder.

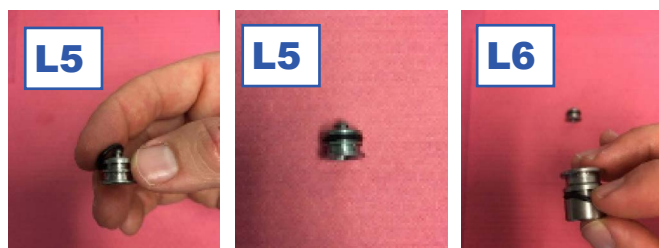

- (L7) Assemble the air valve with the valve holder.

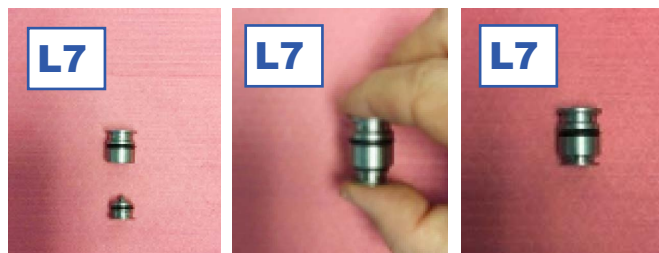

• Reassembling of the labyrinth.

- (L8) Insert the O-Ring 2 gaskets on the labyrinth.

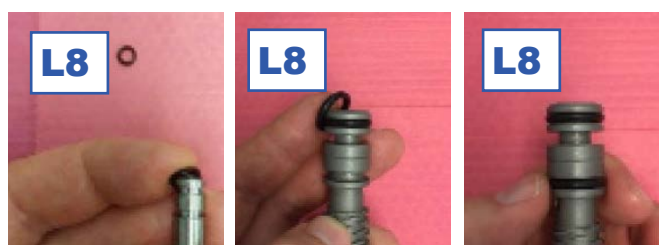

• Reassembling of the sucking tube.

- (L9) Insert the O-Ring 2 gaskets on the sucking tube.

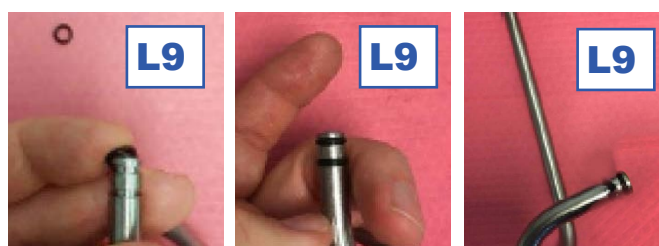

## M Assembling Primary Parts of the Machine:

Reassembling of the labyrinth, tube and faucet.

- (M1) Insert the labyrinth into the hole on the front panel. Insert the end of the labyrinth with the two O-rings in the pump cover.

- (M2) Insert the key in the hole of the pump cover.



- (M3) Insert the tube with the faucet in the hole on the front panel.

- (M4) Rotate the faucet anticlockwise to block it on the front panel.



Reassembling of the sucking tube connection onto the pump cover.

- (M5) Insert the valve holder on the pump cover.



- (M6) Insert the regulation valve in the valve holder.



- (M7) Screw clockwise the air-regulation knob on the valve holder.

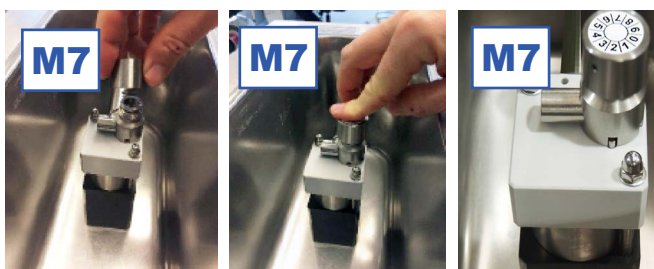

OPERATION

## M Assembling Primary Parts of the Machine:

Reassembling of the sucking tube, positioning of the container and tank lid.

- (M8) Insert the sucking tube in the hole of the valve holder.
- (M8) Push the tube to fix it properly in the valve holder cavity.
- (M9) Place the container in the tank.
- (M9) Put the sucking tube into the container.



## N Sanitizing:

**Sanitizing must be done after the machine is clean and just before the machine is filled with cream. Sanitizing the night before does not ensure sanitization the next day. However, you should always clean the machine and parts after using it.**

**NOTE:** The United States Department of Agriculture and the Food and Drug Administration require that all cleaning and sanitizing solutions used with food processing equipment be certified for this use.

**When sanitizing the machine, refer to local sanitary regulations for applicable codes and recommended sanitizing products and procedures. The frequency of sanitizing must comply with local health regulations. Mix sanitizer in quantities of no less than 1 gallons of 90°F to 110°F (32°C to 43°C) water. Allow sanitizer to contact the surfaces to be sanitized for 5 minutes. Any sanitizer must be used only in accordance with the manufacturer's instructions and to provide a 100 parts per million strength solution.**

## N Sanitizing:

After reinstalling all the machine's components (as previously described), carry out a sanitization with water solution and disinfecting STERA-SHEEN manufactured by PURDY PRODUCTS. Follow accurately the next steps:

- (N1) Prepare a pail with a solution composed by 2 gal. of water (max 40°C) and 2 oz. of disinfecting STERA-SHEEN.



- (N2) Having pressed the PROGRAMMING / ADJUSTMENT + button, the P3 code flashes on the digital display.



- (N3) Setting the continuous dispensing (Co). Maintain the dispensing active until the washing solution contained in the cream container is used up.

- (N4) Pour solution into the cream container up to half of its capacity.



- (N5) Place a suitable container under the dispensing faucet.



- (N5) Press the "DISPENSING" button to drain the solution in the cream container into the appropriate container placed under the dispensing faucet.

- (N6) Press the "DISPENSING" button again to stop the continuous functioning.



**DO NOT RUN THE PUMP WITHOUT SOLUTION IN ORDER TO AVOID TO DAMAGE IT.**

**A POTABLE WATER RINSE IS NOT NECESSARY UNLESS SO SPECIFIED BY STATE OR LOCAL ORDINANCE.**

**AFTER THE SANITIZATION, CLOSE THE LID AND DO NOT TOUCH WITH THE HANDS ANYMORE, NOR DRY WITH CLOTHES OR PAPER ALL PARTS IN DIRECT CONTACT WITH FOOD.**



## P Replacing the gaskets

CHECKING INTERVAL: 500 hours or quarterly

AUTHORISED OPERATOR: 1 Operator

TIME NEEDED: 5 minutes

TOOL: Non-metallic pointed tool

- Regularly check the integrity of the gaskets and substitute them if they are broken, worn or swollen.
- Only use original gaskets, made of food-safe rubber.
- The machine is supplied with a full set of spare gaskets.

**DO NOT PUT GASKETS IN THE INDUSTRIAL DISHWASHER, AS THE HIGH TEMPERATURES COULD DEFORM THEM, MAKING THEM UNUSABLE.**

### a) Gaskets of the air-regulator:

- Remove the air-regulator from the cover pump. Remove the worn gaskets OR (1) from the air-regulator (2), using a non-metallic pointed tool, taking care not to scratch the knob seat.
- Remove all product residues from the seat and fit the new gasket whit lubricating it.
- Reassemble the air-regulator on the cover pump.

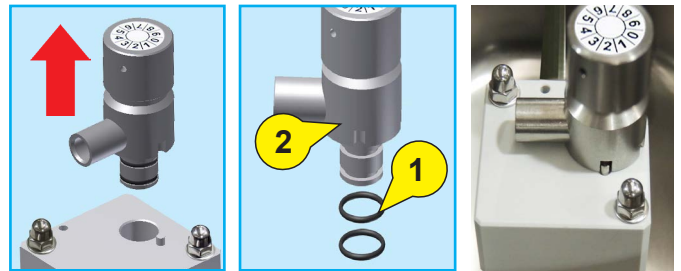

### b) Gaskets of the valve holder and of the air regulating valve

- Screw the air-regulator knob counterclockwise and remove the valve holder vertically and air valve from the air-regulator.
- Remove the worn gaskets OR (3) from valve holder and air valve (4) using a non-metallic pointed tool, taking care not to scratch the knob seat.
- Remove all product residues from the seat and fit the new gaskets (5), lubricating them with the food-safe grease supplied. Place the valve holder and reassemble air valve inside the air-regulator, turn clockwise the air-regulator knob on air-regulator.

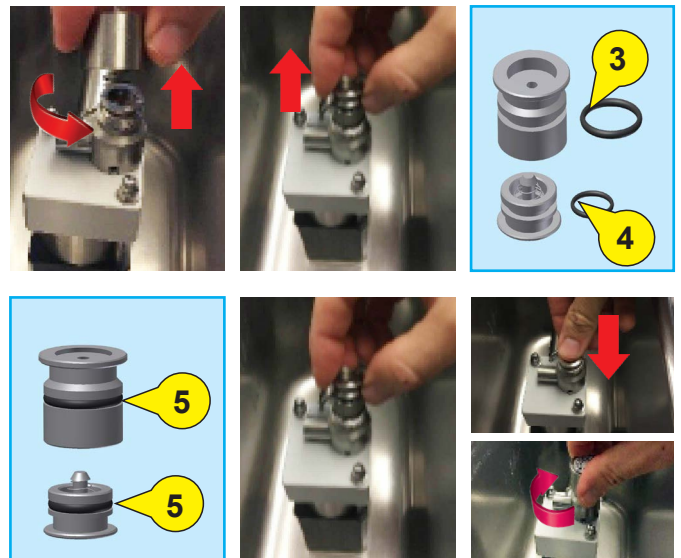

## c) Gaskets of the suction pipe:

- Remove the suction pipe from the air-regulator. Remove the worn gaskets OR (6) from the suction pipe, using a non-metallic pointed tool, taking care not to scratch the knob seat.
- Remove all product residues from the seat and fit the new gaskets (7), lubricating them with the food-safe grease supplied. Reassemble the suction pipe inside the hole of the air-regulator.

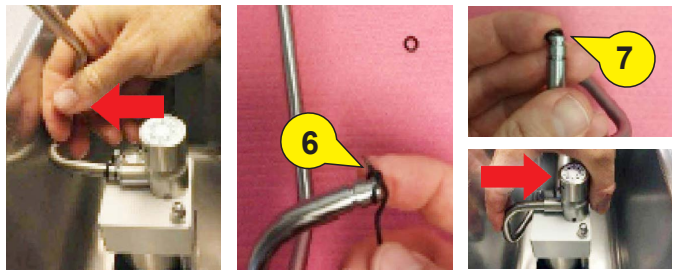

## d) Gaskets of the cream dispenser:

- Unscrew the cream dispenser counterclockwise and remove the nozzle, using if necessary fixing rod, from the dispenser faucet.
- Remove the worn gaskets OR (8) from the nozzle, using a non-metallic pointed tool, taking care not to scratch the knob seat.
- Remove all product residues from the seat and fit the new gaskets (9), lubricating them with the food-safe grease supplied. Screw clockwise the nozzle inside the hole of the dispenser faucet, following Screw clockwise the cream dispenser on the nozzle.

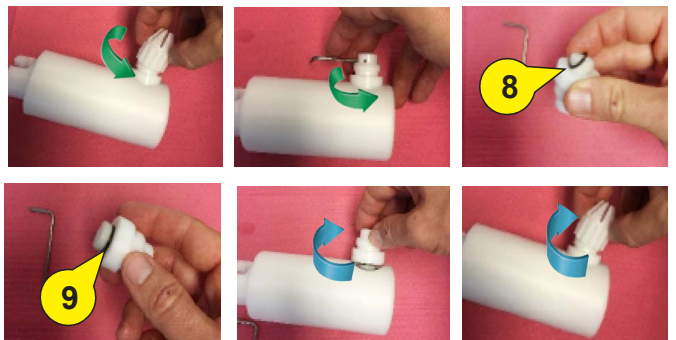





## e) Gaskets of the dispenser faucet and labyrinth:

- Turn 45° clockwise the dispensing faucet, remove it from the machine and then remove the tube. Remove the worn gasket (10) from the faucet using a non-metallic pointed tool, taking care not to scratch the seat.
- Eliminate all product residues from the gasket seat and fit the new gasket (11), lubricating it with the food grease supplied.
- Remove the fixing rod of the labyrinth from the pump cover and then extract the labyrinth from the machine.
- Remove the worn gaskets (12) from the labyrinth using a non-metallic pointed tool, taking care not to scratch the seat. eliminate all product residues from the gaskets seat and fit the new gaskets (13), lubricating them with the food grease supplied.
- Place the labyrinth in the pump cover and block it with the fixing rod. Insert the tube in the dispensing faucet, then insert the ring of the faucet in the pivot on the hole of the front panel of the machine. Turn 45° counterclockwise to block the dispensing faucet.



## Q General alarm indications displayed on the control panel – causes and solutions

FAULT / INCONVENIENCE	INDICATIONS FOR THE OPERATOR	POSSIBLE CAUSES	SOLUTIONS
<p><b>! "P.-" alarm warning</b></p> 		<ul style="list-style-type: none"> <li>The tank temperature probe signals a temperature higher than the safety limits. Faulty temperature probe (interrupted or out of tolerance) and/or related wiring damaged.</li> </ul>	<ul style="list-style-type: none"> <li>Contact the <i>Technical Assistance Service</i>.</li> </ul>
<p><b>! "PE" alarm warning</b></p> 		<ul style="list-style-type: none"> <li>The tank temperature probe signals a temperature lower than the safety limits. Faulty temperature probe (interrupted or out of tolerance) and/or related wiring damaged.</li> </ul>	<ul style="list-style-type: none"> <li>Contact the <i>Technical Assistance Service</i>.</li> </ul>

## R Troubleshooting – flowchart

In fault conditions the machine may malfunction, as specified below:

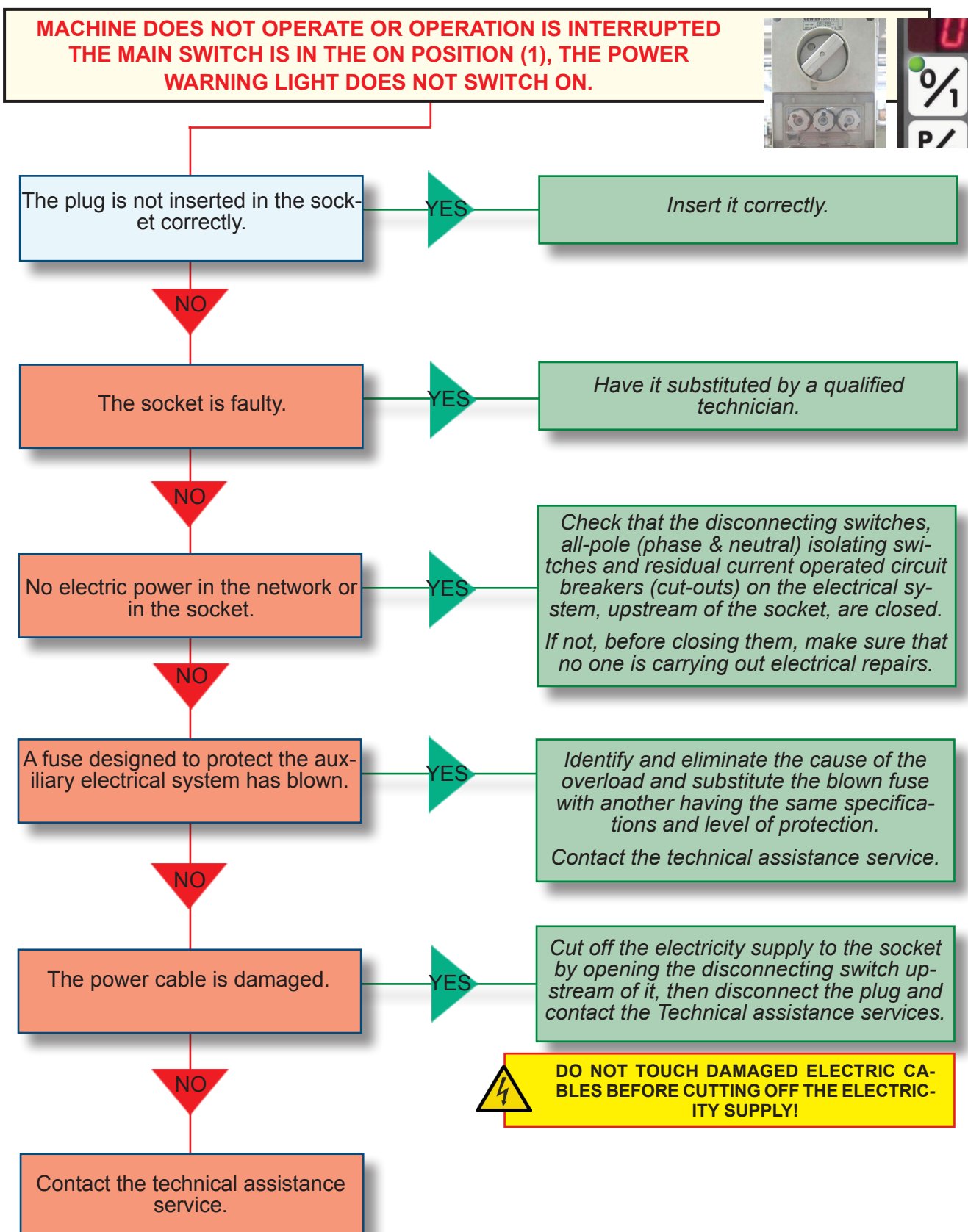

TROUBLESHOOTING

**MACHINE REPEATEDLY TRIPS THE ELECTRIC OVERLOAD SWITCHES OR BLOWS THE MAINS FUSES.**

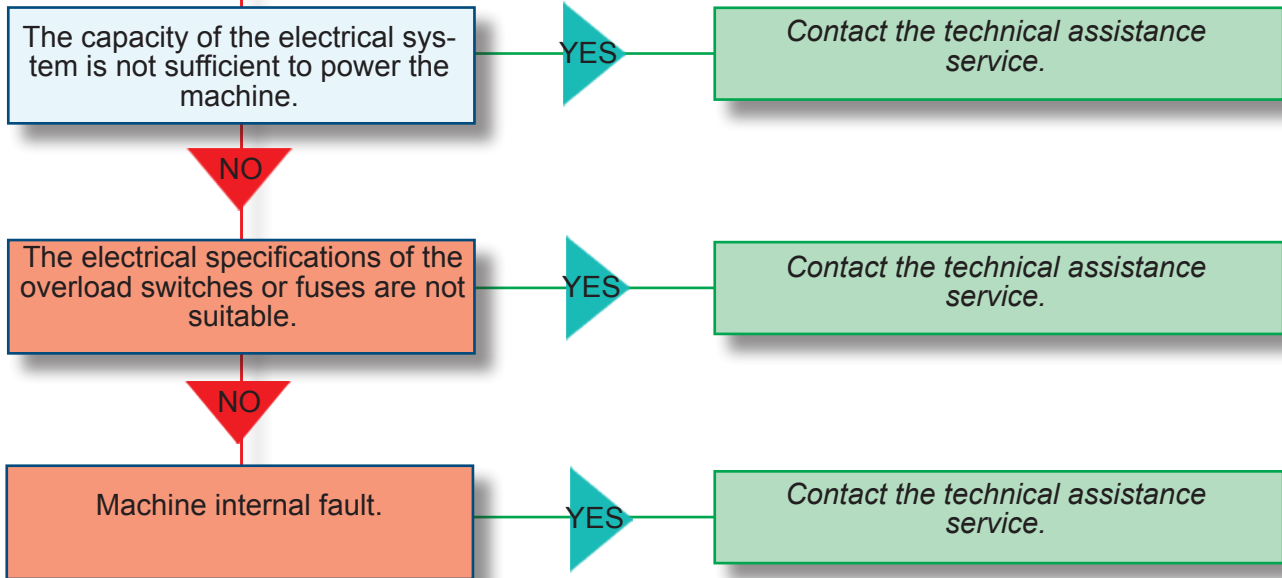

**CREAM COMES OUT LIQUID WET OR FLABBY.**

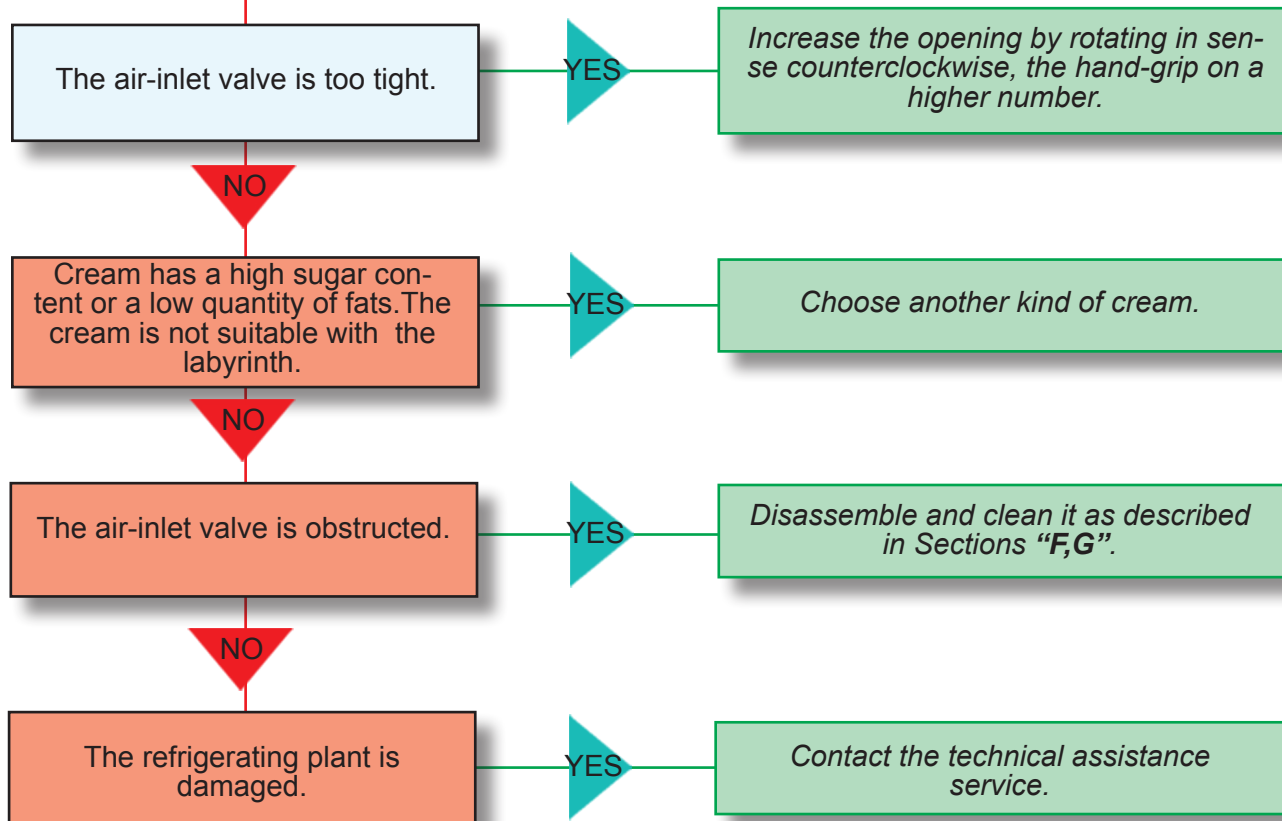

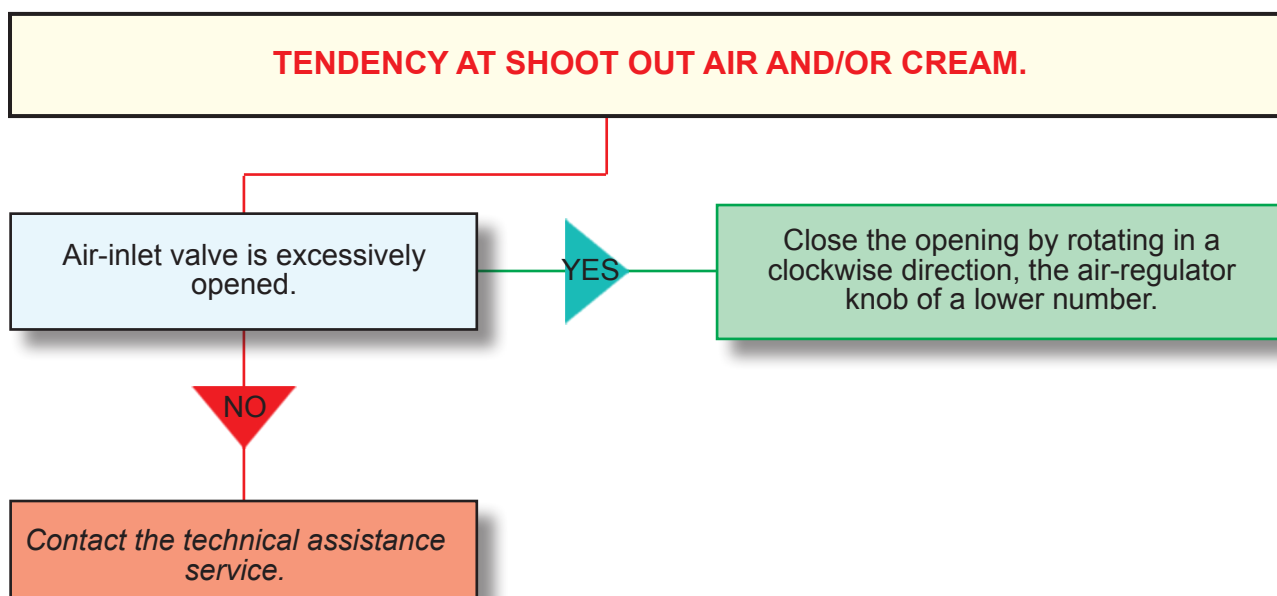
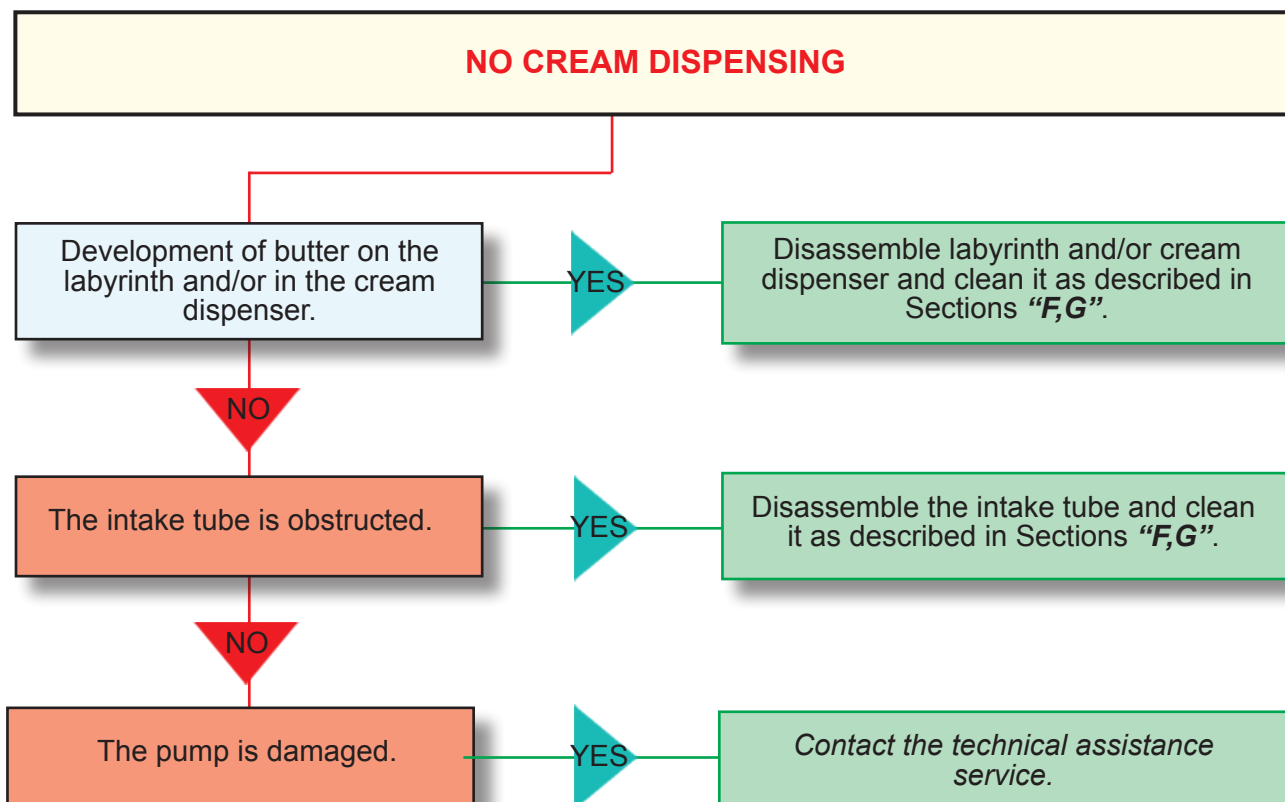

**AIR COOLING IS INSUFFICIENT OR SWITCHES OFF IN A FAULTY WAY**

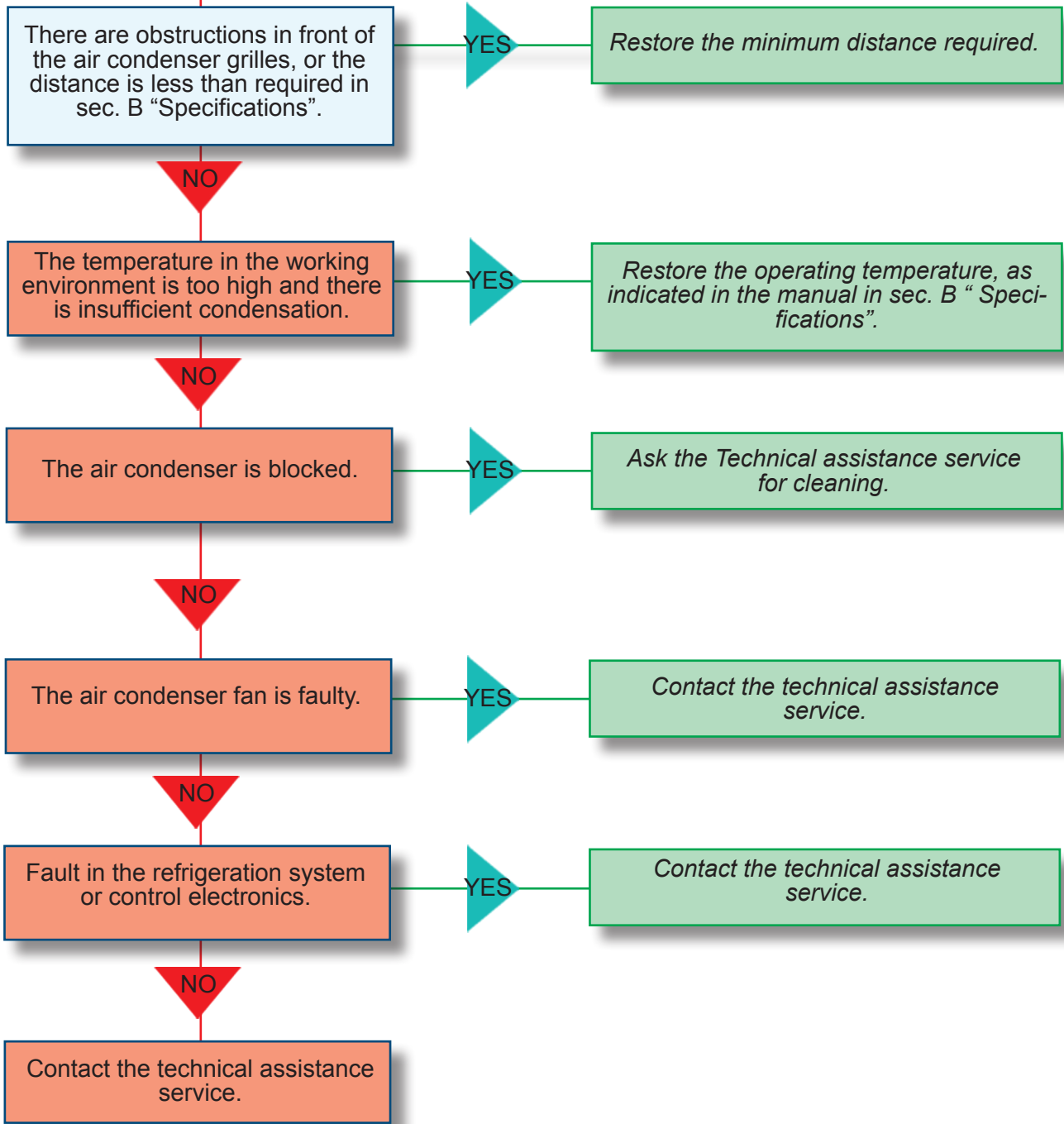

TROUBLESHOOTING



# Section 6 : Replacement Parts

## S Replacement Parts:

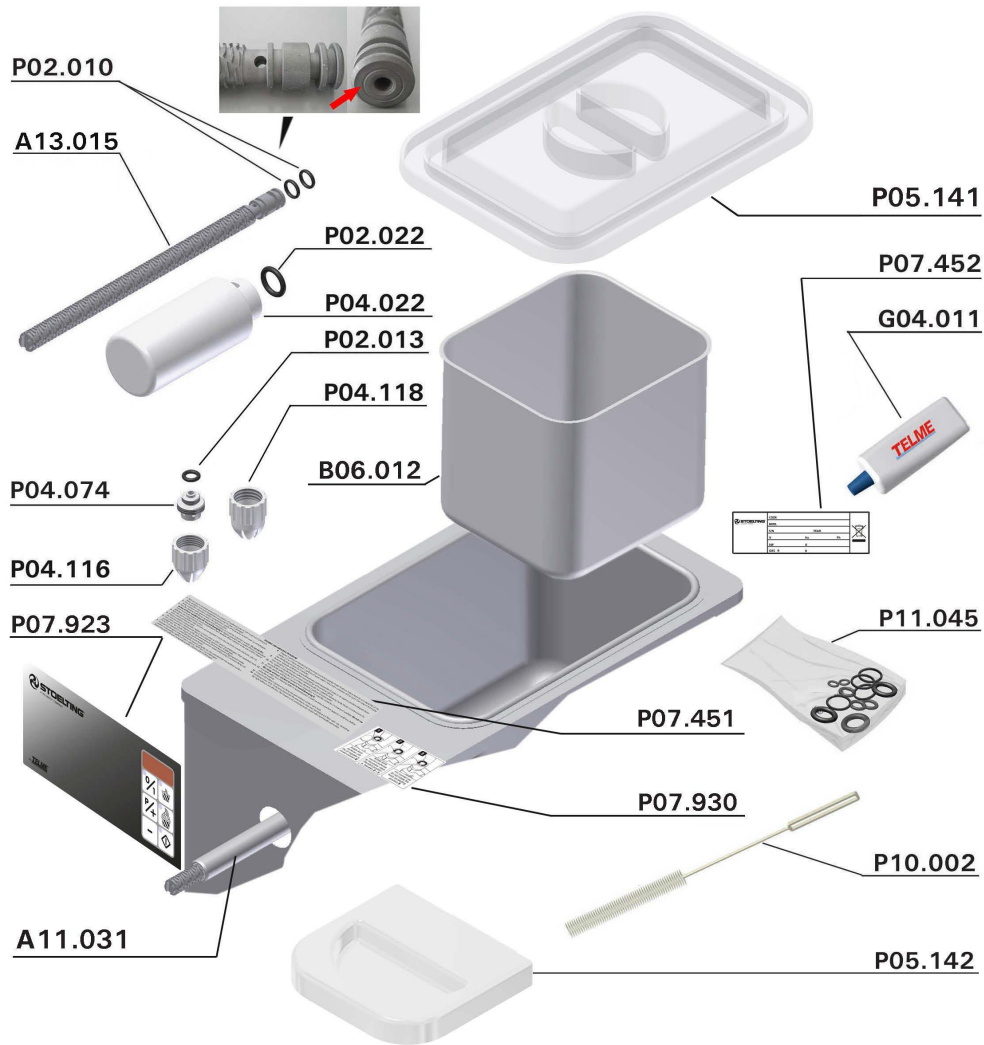

Part Number	Description	Quantity
<a href="#">A13.015</a>	LABYRINTH 1.5 (E SERIES)	1
<a href="#">A11.031</a>	LABYRINTH TUBE	1
<a href="#">B06.012</a>	CREAM CONTAINER	1
<a href="#">G04.011</a>	EP1 FOOD LUBRICANT TUBE	1
<a href="#">P02.010</a>	GASKET O-RING 3043	2
<a href="#">P02.013</a>	GASKET O-RING 2050	1
<a href="#">P02.022</a>	GASKET O-RING 20x3	1
<a href="#">P04.022</a>	DISPENSING FAUCET	1
<a href="#">P04.074</a>	CREAM DISPENSER	1
<a href="#">P04.116</a>	WHITE OUTLET NOZZLE (E SERIES)	1
<a href="#">P04.118</a>	WHITE OUTLET NOZZLE (T SERIES)	1
<a href="#">P05.141</a>	LID	1
<a href="#">P05.142</a>	DRIP TRAY	1
<a href="#">P07.451</a>	CLEANING LABEL	1
<a href="#">P07.452</a>	TECHNICAL DATA LABEL	1
<a href="#">P07.923</a>	FRONT SIDE LABEL	1
<a href="#">P07.930</a>	AIR REGULATOR USE DECAL	1
<a href="#">P10.002</a>	CLEANING BRUSH D.16 x 301	1
<a href="#">P11.045</a>	GIVING KIT - SPARE PART	1

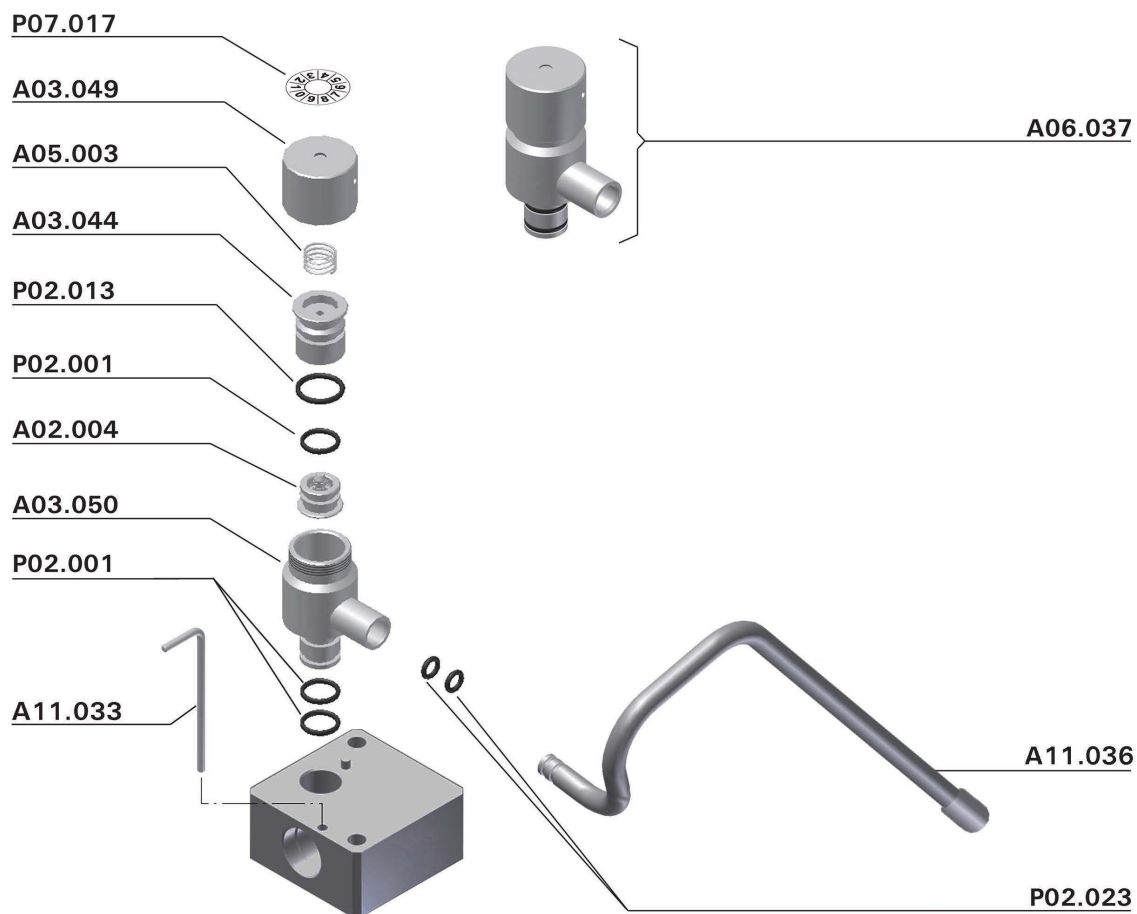

Part Number	Description	Quantity
A02.004	REGULATING VALVE	1
A03.044	VALVE HOLDER	1
A03.049	AIR REGULATING KNOB	1
A03.050	SUCTION PIPE CONNECTION	1
A05.003	AIR REGULATION SPRING (DIM D21800)	1
A06.037	AIR REGULATOR ASSEMBLY (E SERIES)	1
A11.033	FIXING ROD	1
A11.036	SUCTION PIPE	1
P02.001	GASKET O-RING 2037	3
P02.013	GASKET O-RING 2050	1
P02.023	GASKET O-RING 5x1,5	2
P07.017	AIR REGULATOR DECAL	1



PART



## DOMESTIC WARRANTY (Including Mexico)

1. **Scope:**

Stoelting, A Vollrath Company (“Stoelting”) warrants to the first user (the “Buyer”) that the Stoelting-branded freezer equipment (the “Equipment”) will be free from defects in materials and workmanship under normal use and proper maintenance for the period listed below in the Warranty Period section. All warranty periods begin on the date of original install or one (1) year from the shipping date, whichever occurs first. This warranty is subject to all conditions, exceptions, and limitations contained herein.

2. **Disclaimer of Other Warranties:**

**THIS WARRANTY IS EXCLUSIVE; AND STOELTING HEREBY DISCLAIMS ANY IMPLIED WARRANTY OF MERCHANTABILITY OR FITNESS FOR PARTICULAR PURPOSE.**

3. **Remedies:**

Stoelting’s sole obligations, and Buyer’s sole remedies, for any breach of this warranty shall be, at Stoelting’s option, one of the following: repair or replacement of the affected component at Stoelting’s plant in Kiel, Wisconsin, or refund of the purchase price of the affected Equipment. Stoelting, through an Authorized Stoelting Provider, will deinstall/reinstall the affected component from/into the equipment (“Labor”) for the period listed below in the Warranty Period section. These obligations/remedies are subject to the conditions that Buyer (a) signs and returns to Stoelting, upon installation, the Start-Up and Training Checklist for the affected equipment, (b) gives Stoelting prompt written notice of any claimed breach of warranty within the applicable warranty period, and (c) delivers the affected equipment to Stoelting or its designated service location, in its original packaging/crating, also within that period. Buyer shall bear the cost and risk of shipping to and from Stoelting’s plant or designated service location.

4. **Warranty Period:**

Equipment	Part	Part Warranty Period	Labor Warranty Period
Soft Serve & Shake	Freezing Cylinders	Five (5) Years	Twelve (12) Months
	Hoppers		
	Compressors		
	Drive Motors		
	Speed Reducers		
	Augers		
Frozen Uncarbonated Beverage	Evaporator	Five (5) Years	Twelve (12) Months
	Compressors		
	Drive Motors		
	Speed Reducers		
Custard & Batch	Freezing Cylinders	Two (2) Years	Twelve (12) Months
	Hoppers		
	Compressors		
	Drive Motors		
	Speed Reducers		
	Beaters		
Dipping Cabinets & Display Cabinets	All components	Twelve (12) Months	Twelve (12) Months
Frozen Beverage / Granita Dispenser	Compressors	Five (5) Years	Twelve (12) Months
	Electronic Board	Three (3) Years	
	All other components	Two (2) Years	
AutoVend	All components	Twelve (12) Months	Twelve (12) Months
Crème Whippers	Compressors	Two (2) Years	Twelve (12) Months
	Motors		
	Condensers		
All equipment	All other components not specified above	Twelve (12) Months	Twelve (12) Months



## DOMESTIC WARRANTY (Including Mexico)

### 5. Conditions:

- a) If the date of the original installation cannot be verified, these warranty periods begin one (1) year from the shipping date. It is the responsibility of the seller to disclose this information to the Buyer at the time of sale.
- b) Stoelting shall not be responsible to provide any remedy under this warranty with respect to any component that fails by reason of negligence, abnormal use, misuse or abuse, faulty repair made by others, use with parts or equipment not manufactured or supplied by Stoelting, any modification or alteration of any parts or equipment, or damage in transit.
- c) This warranty is valid only if the Equipment is installed and serviced by an Authorized Stoelting Provider and only if new, genuine Stoelting parts are used.
- d) The Equipment installation location must have suitable conditions as explained in the Stoelting operators manual, specification sheet, and/or technical manual including but not limited to, ambient temperature, water supply parameters, and space requirements.
- e) The Authorized Stoelting Provider must return defective parts, at Stoelting's discretion, for credit.
- f) Any refrigerant other than that specified on the Equipment model identification nameplate voids this warranty.

### 6. Exceptions:

This warranty does **NOT** cover any of the following

- a) Costs associated with installation labor, disposal of equipment being replaced, and shipping costs of replacement parts or Equipment.
- b) Cleaning, maintenance or lubrication of the Equipment as outlined in the Stoelting operators manual.
- c) This warranty does not extend to parts, sometimes called "wear parts", which are generally expected to deteriorate and to require replacement as equipment is used, including but limited to o-rings, auger flights, auger seals, auger support bushings, and drive belts. All such parts are sold **AS IS**.
- d) External components including but not limited to hoses, piping, or electrical equipment.
- e) Labor and travel charges due to return trips or waiting if the Authorized Stoelting Provider is prevented from promptly starting service work upon arrival. This exception includes labor charges incurred for limited access facilities including, but not limited to, government and military buildings, and airports.
- f) Failure, damage, or repairs due to faulty installation, misapplication, abuse, lack of service, or improper service, unauthorized alteration, improper operation as indicated in the Stoelting operators manual, including but not limited to failure to properly assemble and/or clean, improper tool usage, or use of unapproved lubrication, or cleaning and sanitizing supplies.
- g) Any costs associated with electricity, including utility increases, from any reason whatsoever.
- h) Damage resulting from the use of refrigerant other than that specified on the Equipment model identification nameplate.
- i) The use of this equipment as a rental asset negates all warranties associated with the equipment.
- j) Any special, indirect or consequential property or commercial damage of any nature whatsoever, if the jurisdiction allows this exclusion.
- k) Costs not covered by the Stoelting Travel Pay policy. Stoelting covers only the first trip travel which is a flat rate by mileage one-way from the service company's home location to the job site. The flat rate is calculated as follows:

○ 0-50 Miles	\$85
○ 51-110 Miles	\$127
○ 111-160 Miles	\$165
○ Over 160 Miles	The maximum reimbursed by Stoelting is \$165

Any travel costs not covered may be invoiced to the customer.

### 7. Limitations:

**THE REMEDIES SET FORTH IN THIS WARRANTY SHALL BE THE SOLE LIABILITY STOELTING AND THE EXCLUSIVE REMEDY OF BUYER WITH RESPECT TO EQUIPMENT SUPPLIED BY STOELTING; AND IN NO EVENT SHALL STOELTING BE LIABLE FOR ANY INCIDENTAL OR CONSEQUENTIAL DAMAGES, INCLUDING AS EXAMPLES BUT NOT INTENDED TO BE LIMITED TO DOWNTIME, OVERHEAD, MATERIALS, PERFORMANCE PENALTIES, LOST SALES, LOST PROFITS, PRODUCT LOSS, OR PROPERTY DAMAGES, WHETHER FOR BREACH OF WARRANTY OR OTHER CONTRACT BREACH, NEGLIGENCE OR OTHER TORT, OR ON ANY STRICT LIABILITY THEORY.**



updated 11-11-2019