

**STORING**  
 MIL. WISCONSIN U.S.A. 53042  
 ELECTRICAL WIRING DIAGRAM  
 MODEL: DQ/U431-1092A, U431-1092A  
 DQ/U431-1092, U431-1092  
 DIAGRAM NO.: 2208213-WD

**CAUTION**  
 DISCONNECT POWER SUPPLY  
 BEFORE SERVICING

2208213-WD

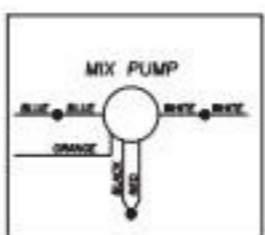

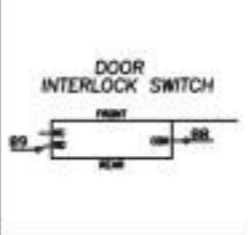
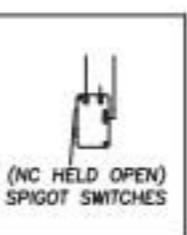
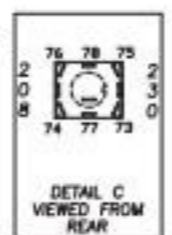
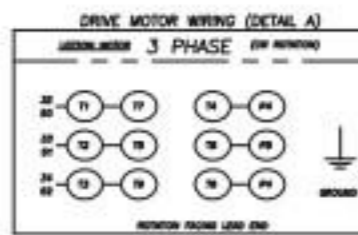
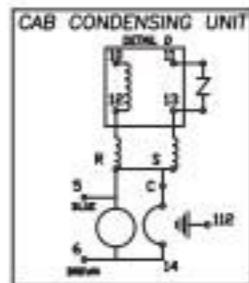
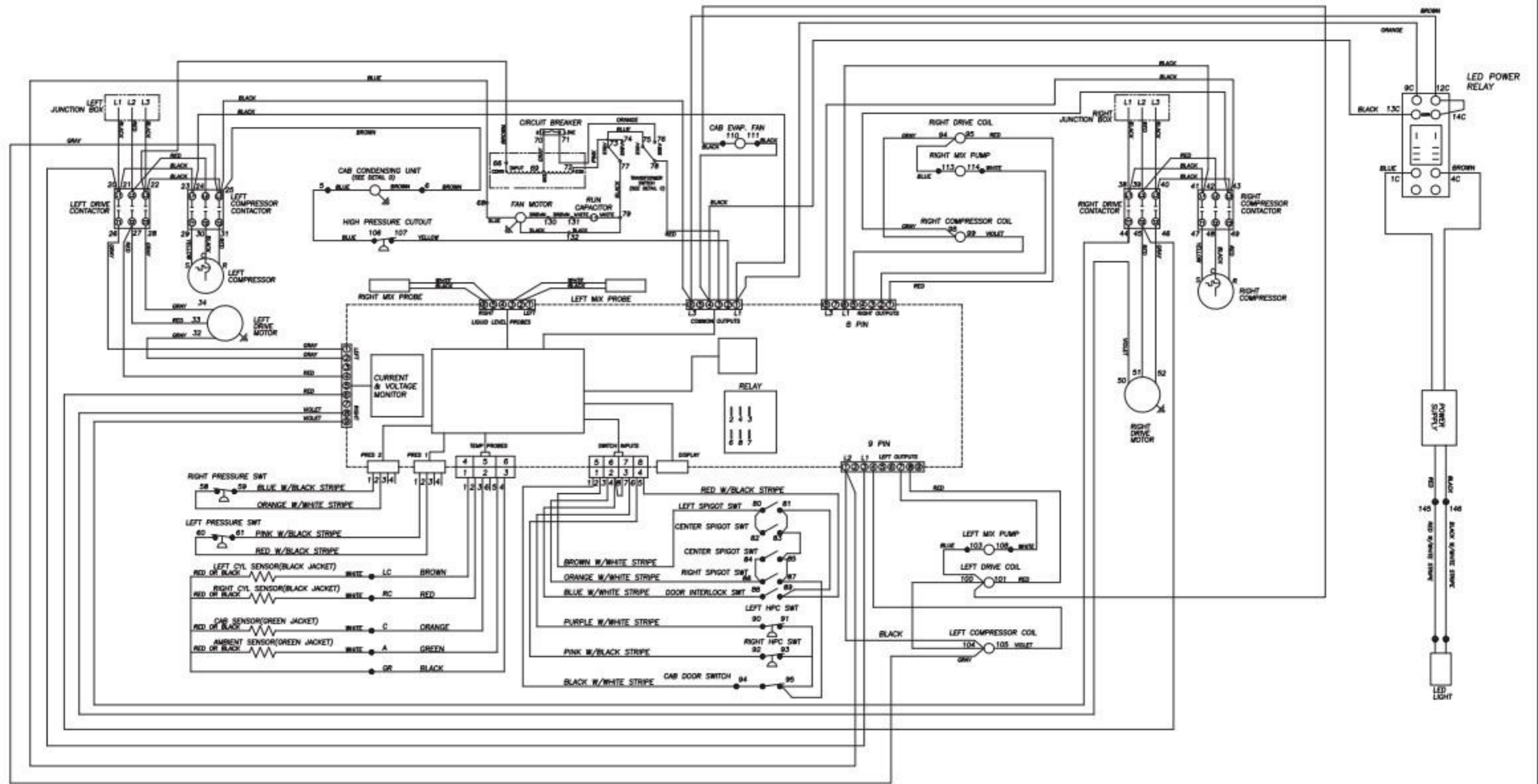
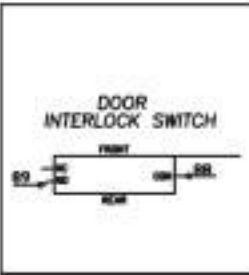
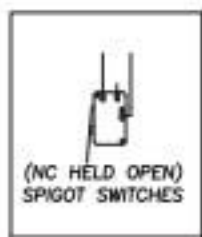
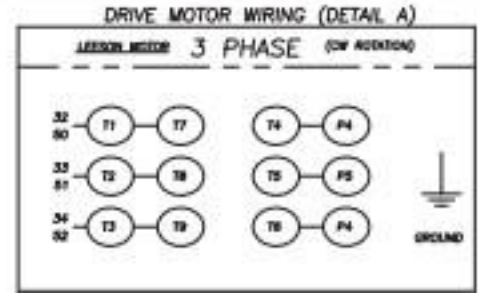
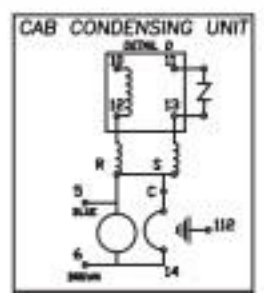
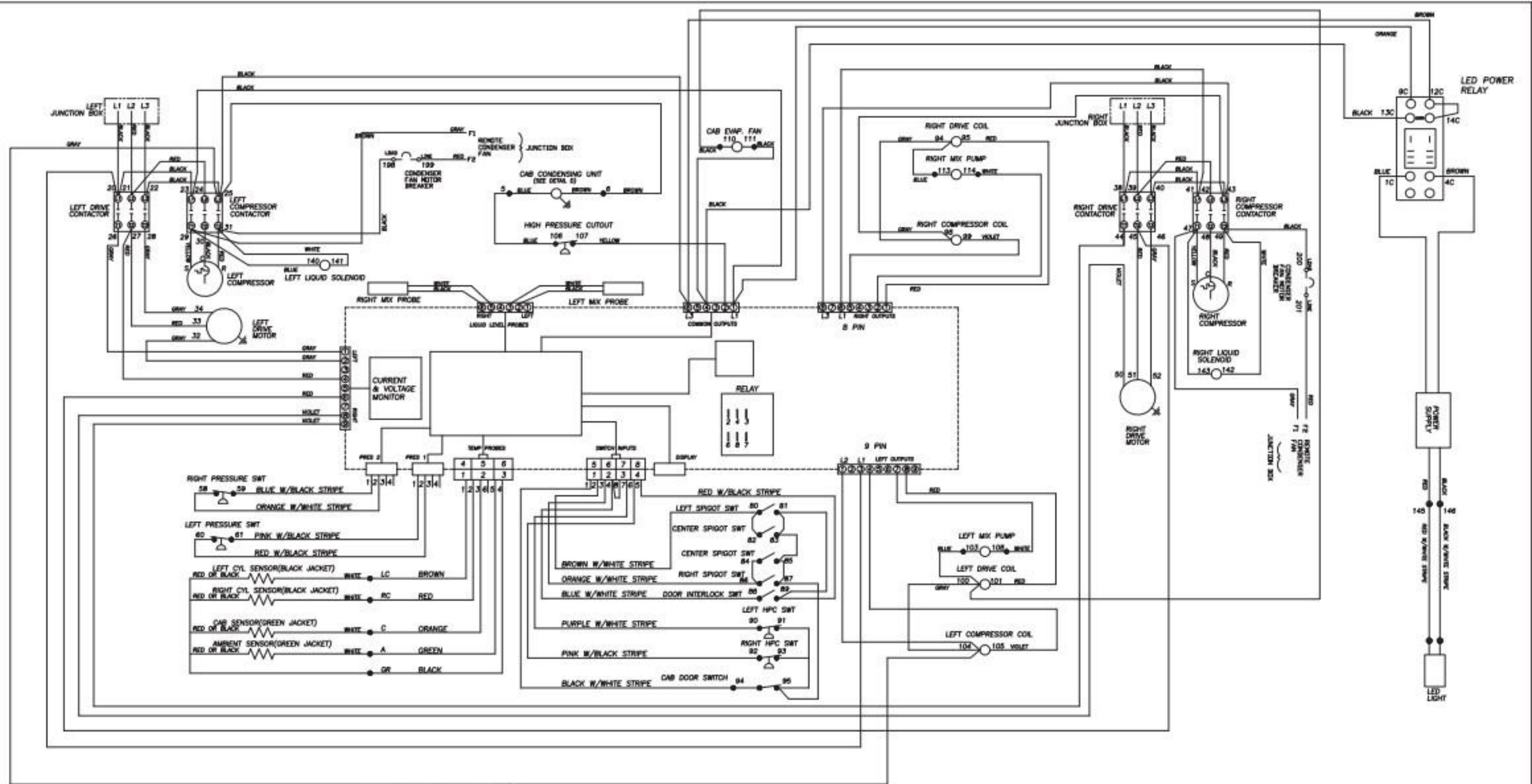

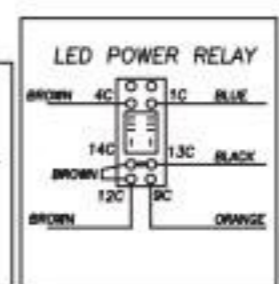
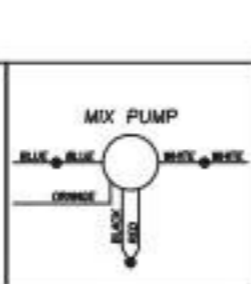
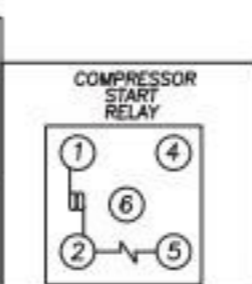
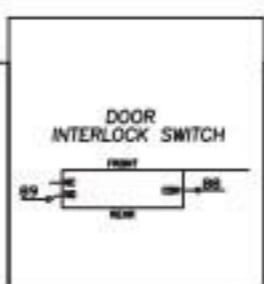
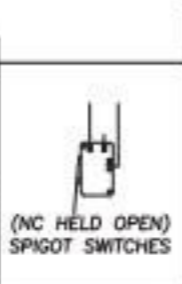
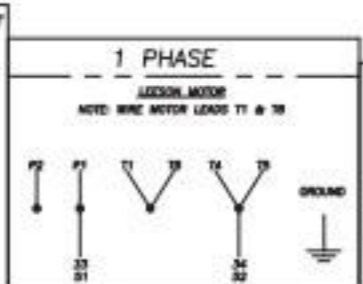
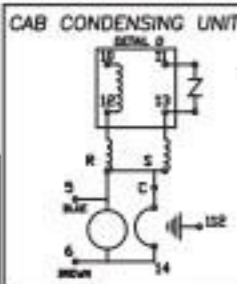
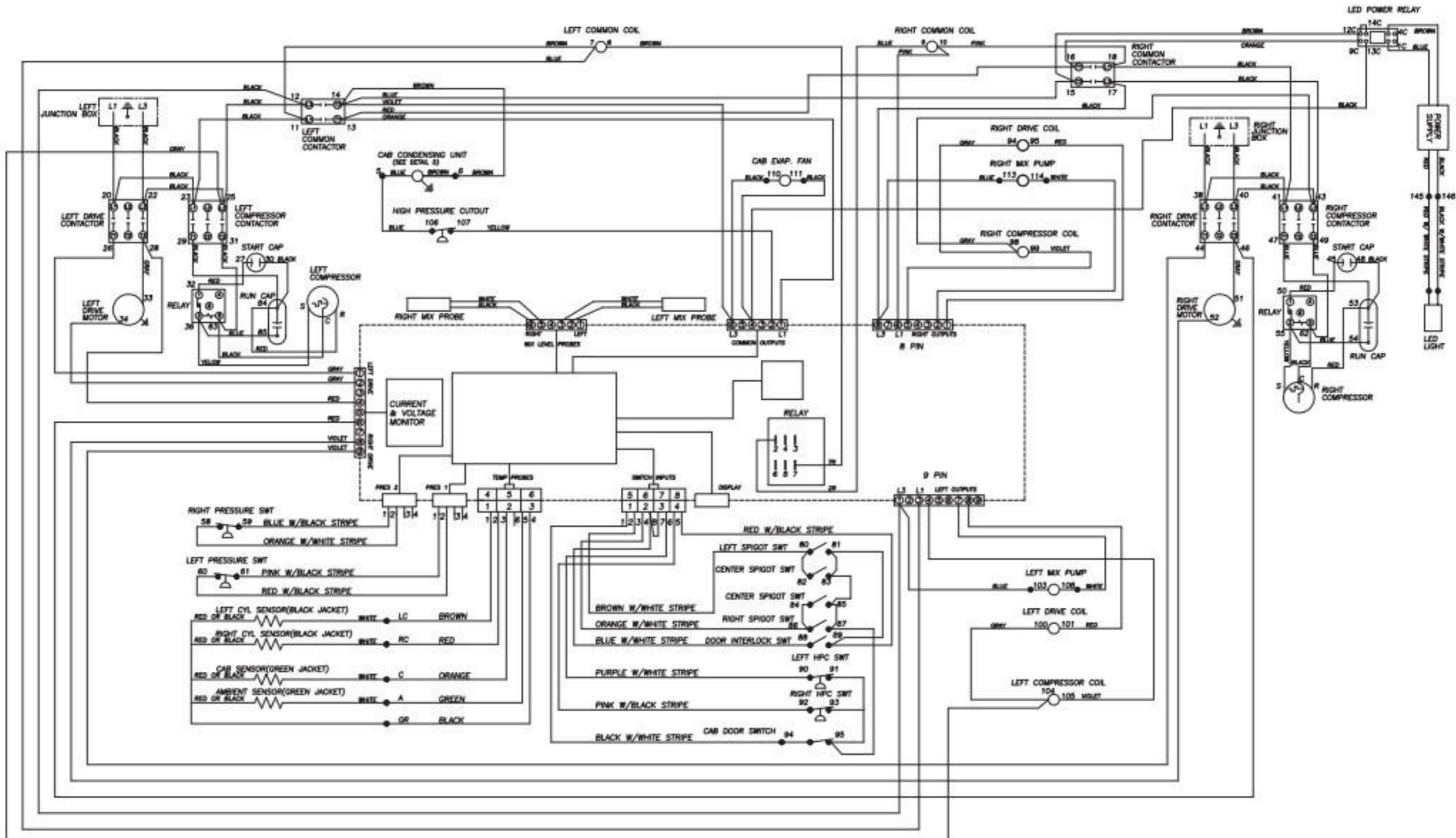

**STORING**  
 REL, WISCONSIN U.S.A. 53042  
 ELECTRICAL WIRING DIAGRAM  
 MODEL: DQ431-182A, U431-182A  
 DQ431-182, U431-182  
 DIAGRAM NO.: 2208080-WD

2208080-WD

**CAUTION**  
 DISCONNECT POWER SUPPLY  
 BEFORE SERVICING

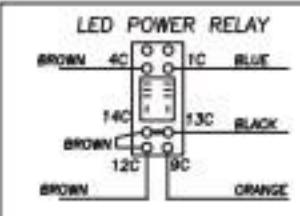
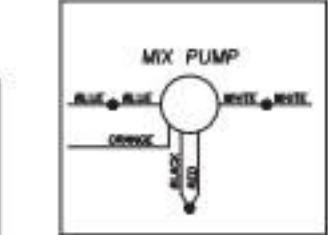
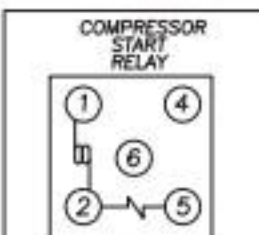
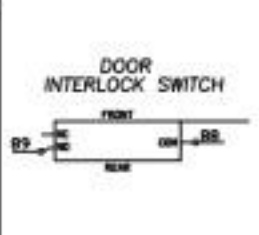
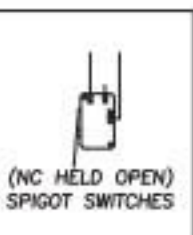
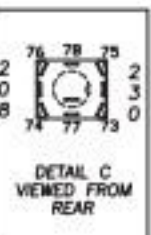
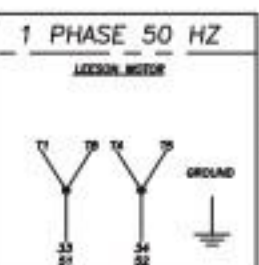
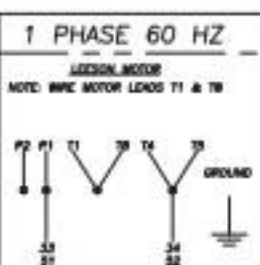
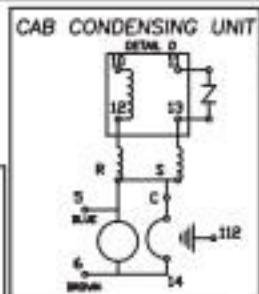
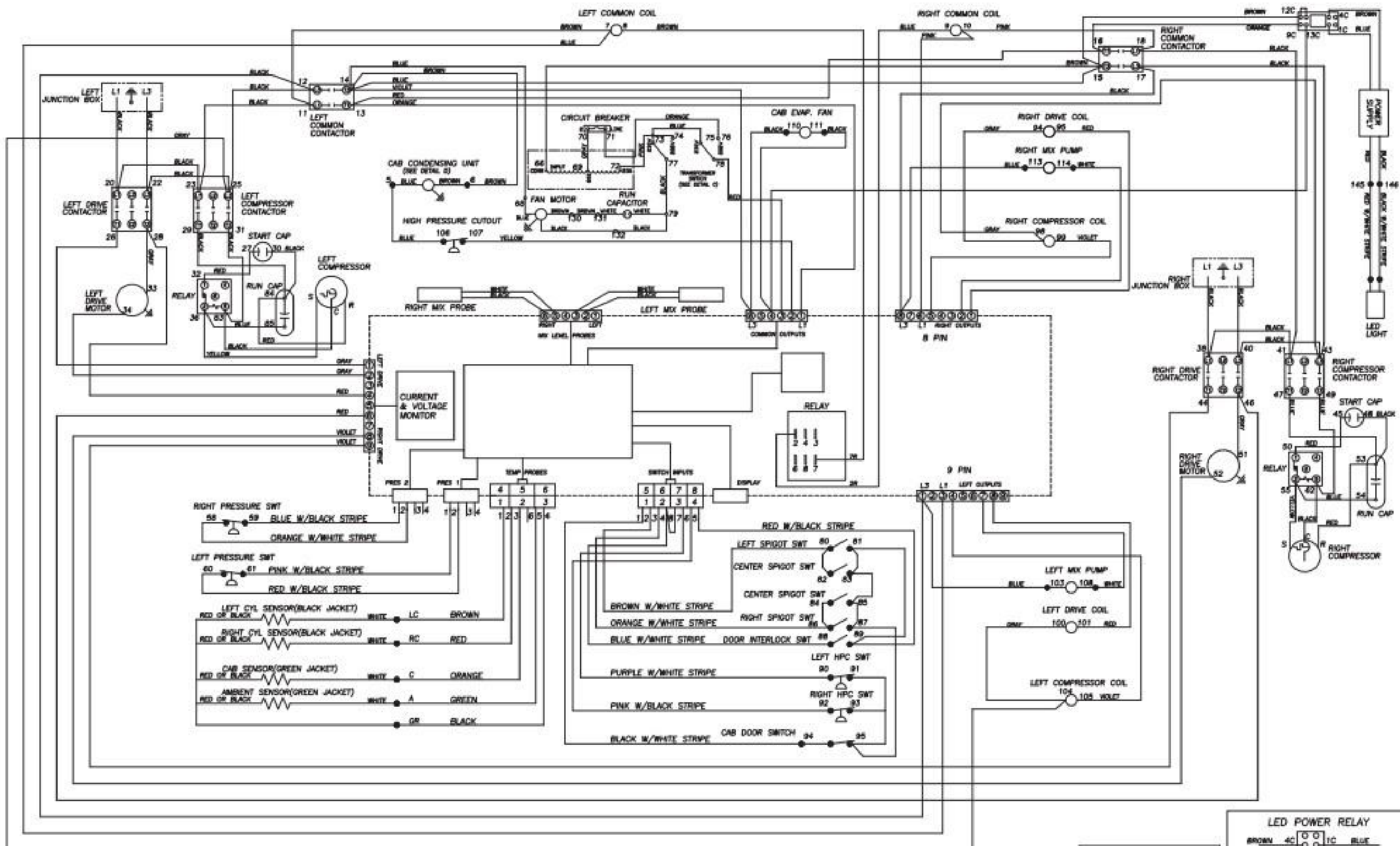

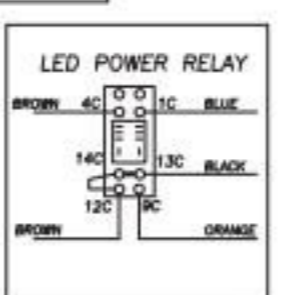
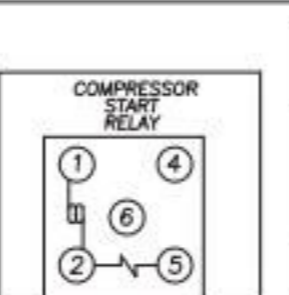
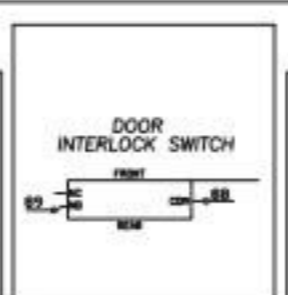
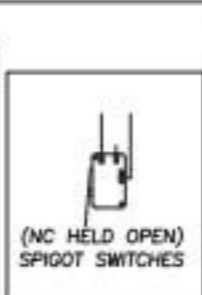
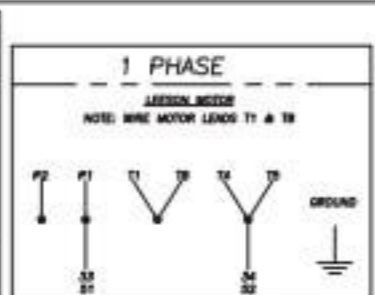
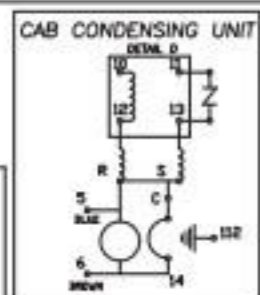
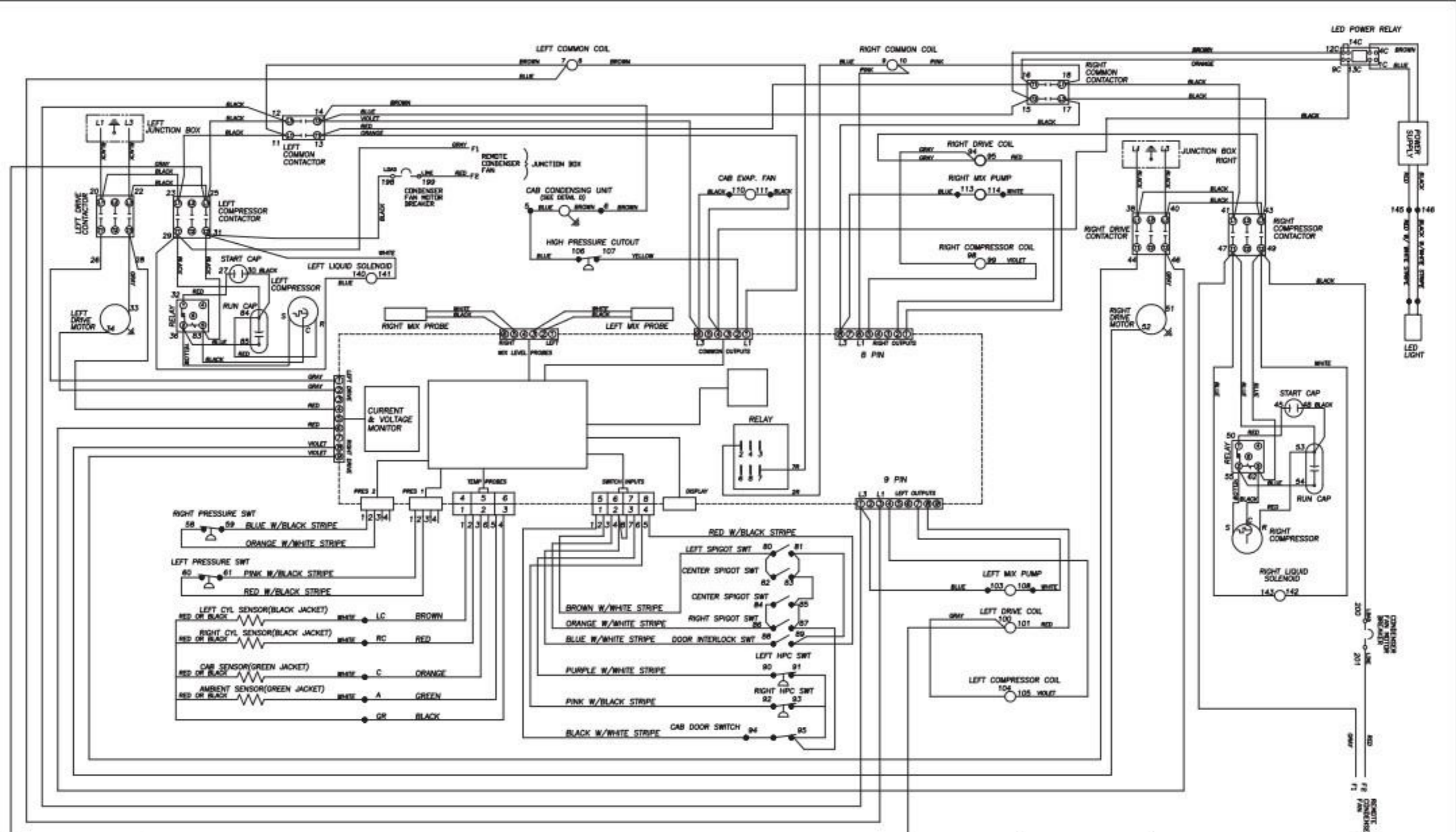

CONDENSING UNIT DETAIL D  
 CAB CONDENSING UNIT  
 JUNCTION BOX

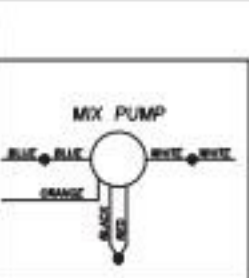
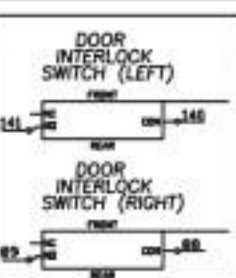
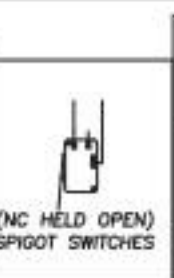
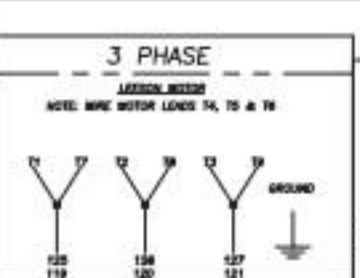
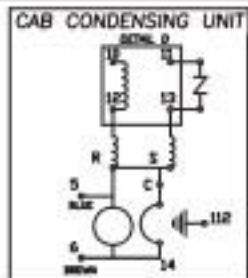
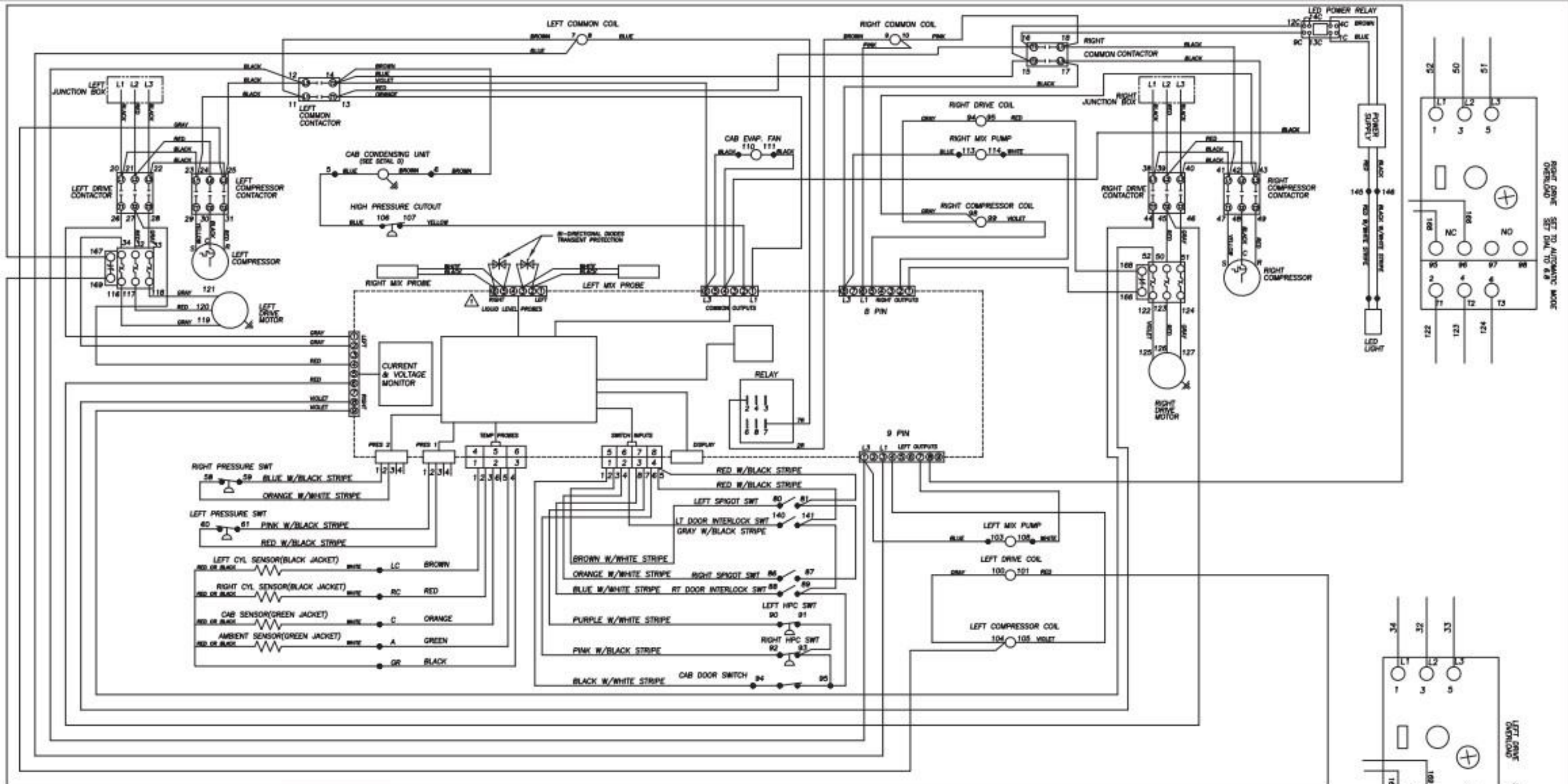

2208129-WD

**CAUTION**  
DISCONNECT POWER SUPPLY BEFORE SERVICING

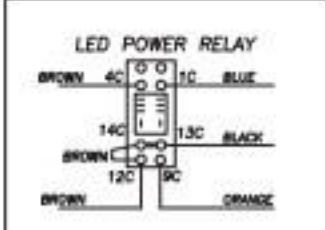
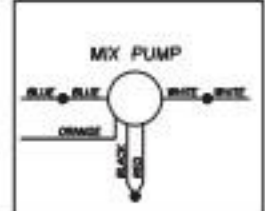
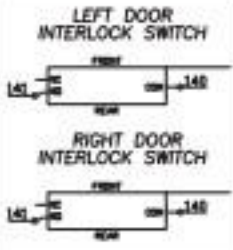
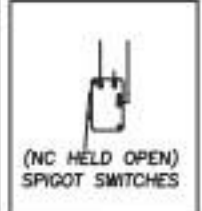
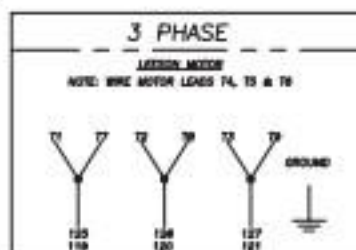
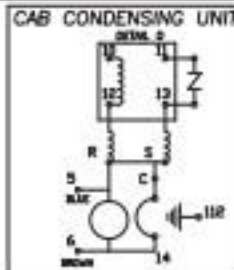
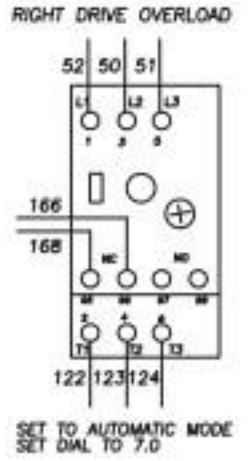
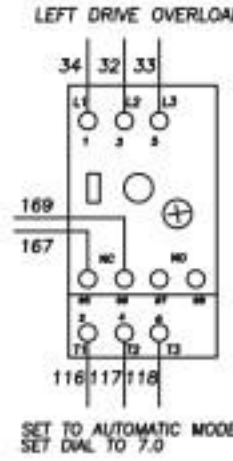
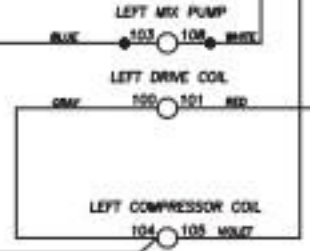
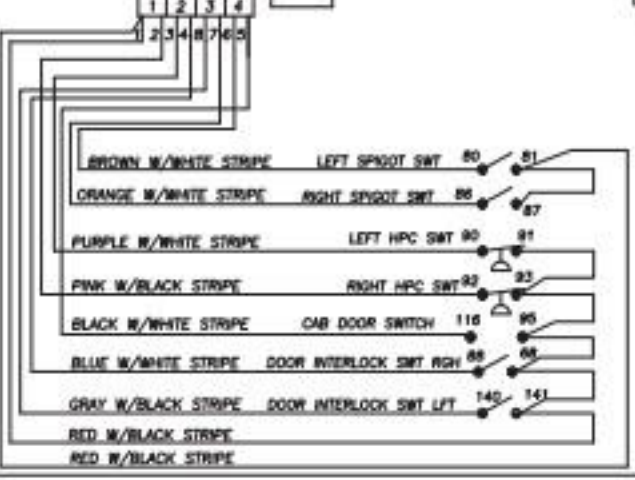
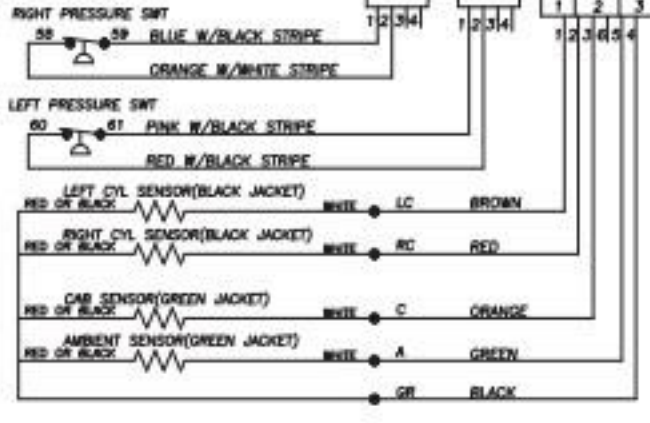
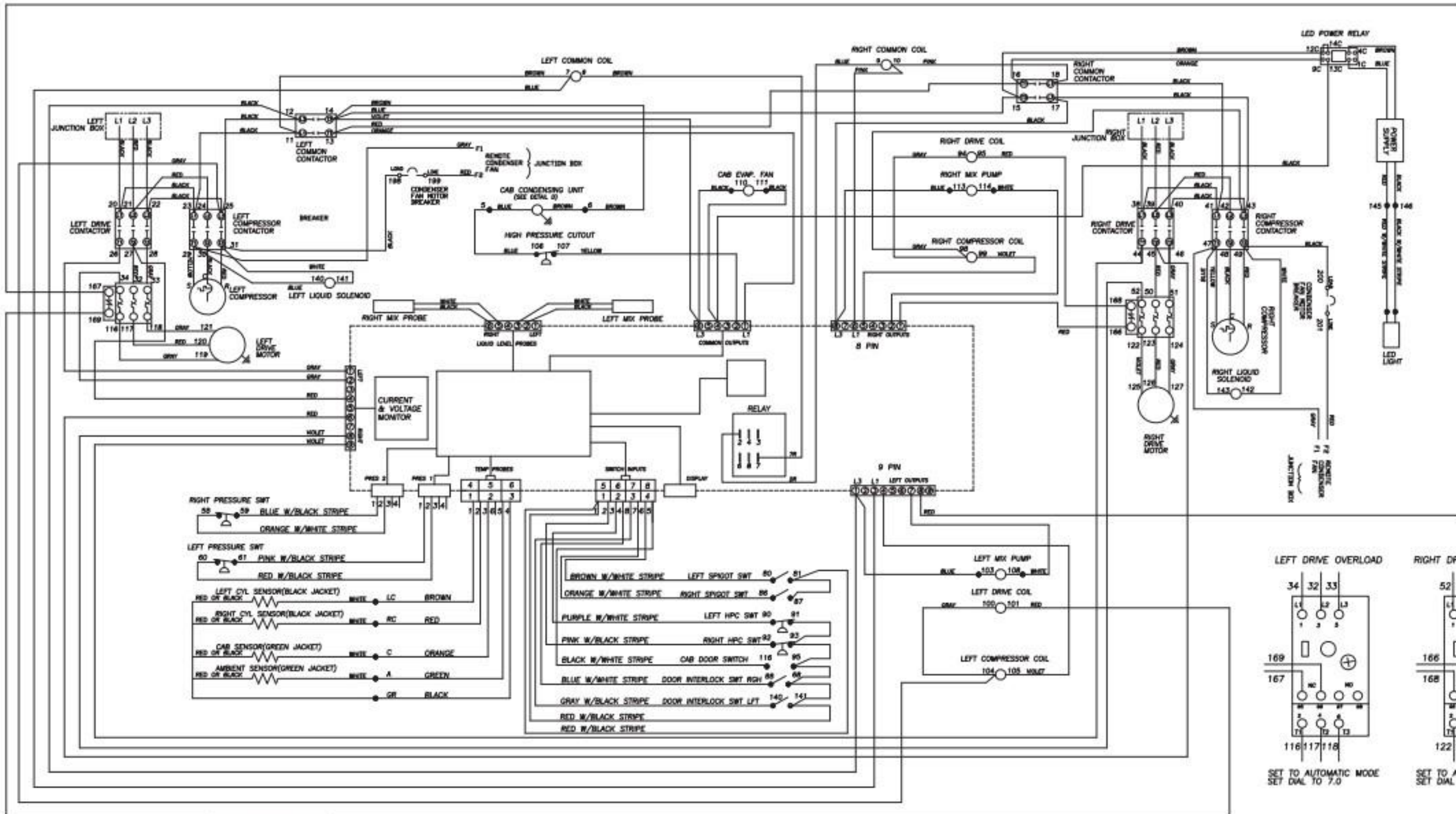

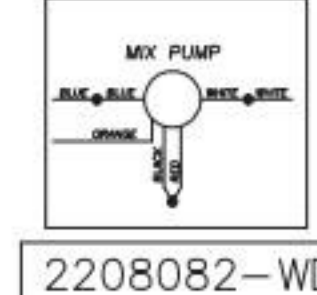
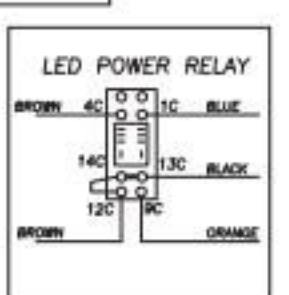
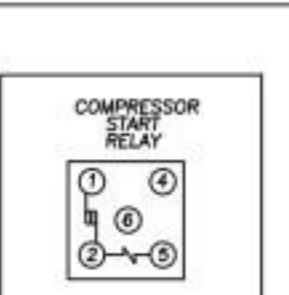
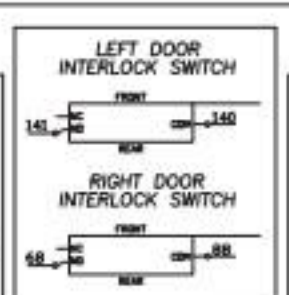
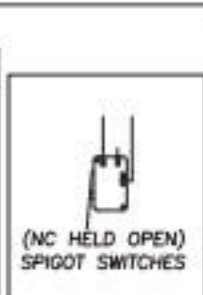
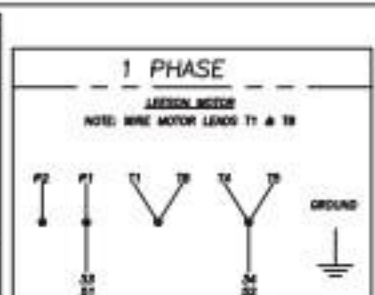
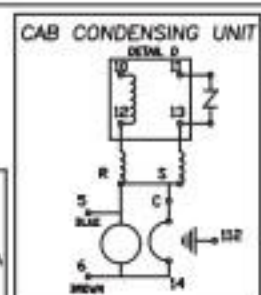
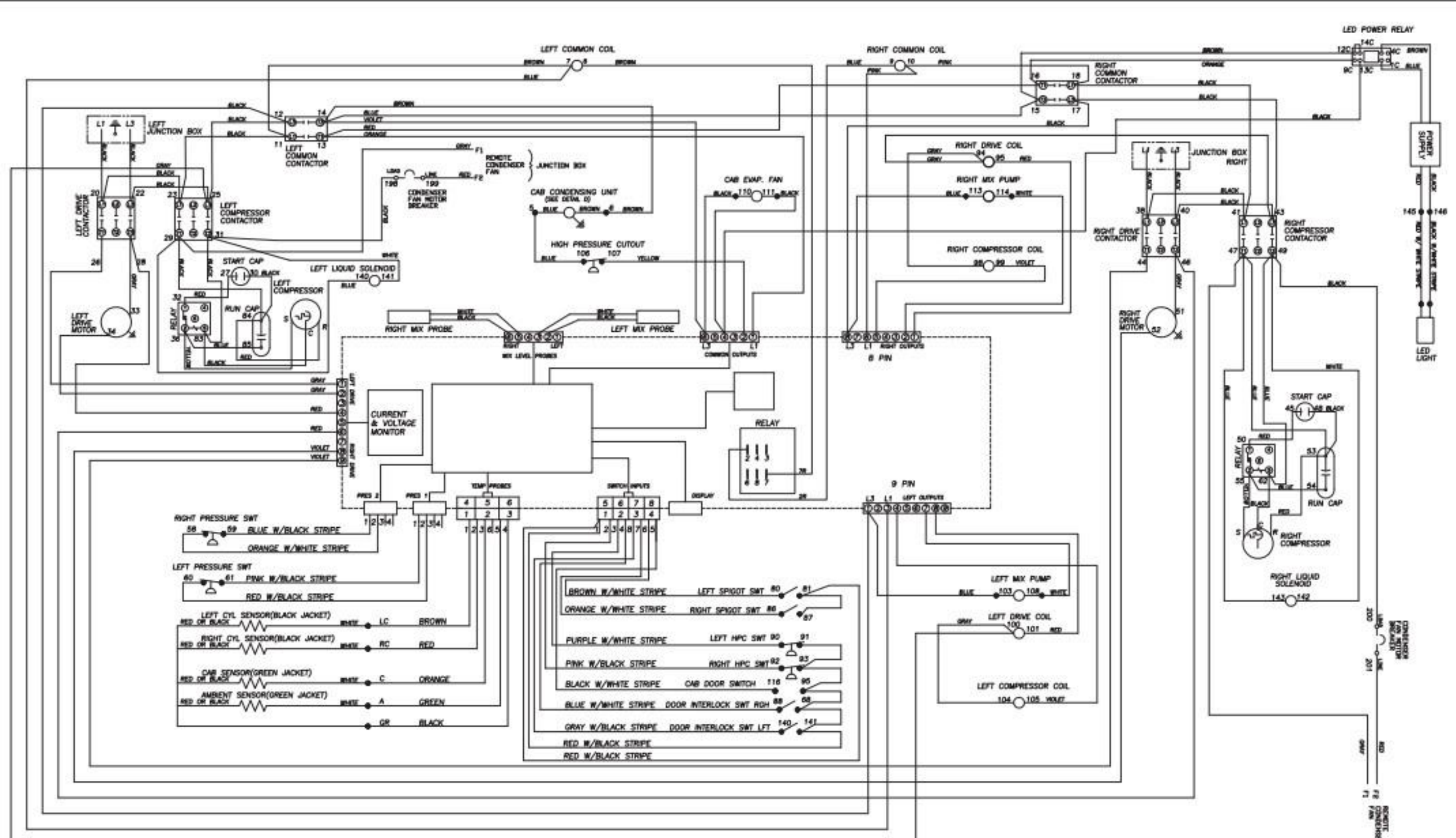

**CAUTION**  
 DISCONNECT POWER SUPPLY  
 BEFORE SERVICING

2208082-WD