

DRIVE MOTOR WIRING

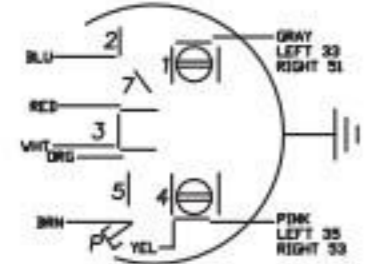

DRIVE MOTOR DETAIL
USE MOTOR LABEL FOR ADDITIONAL DETAILS
NOTATION ON FACING SWITCH END

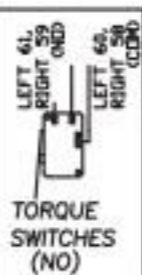
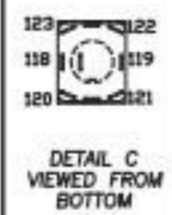
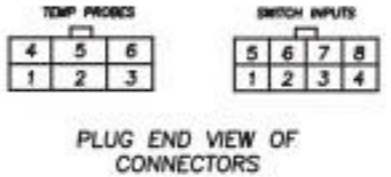
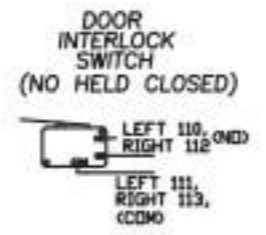
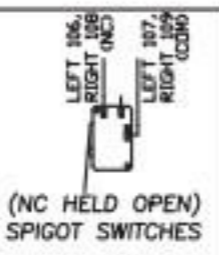

CAUTION

DISCONNECT POWER SUPPLY BEFORE SERVICING

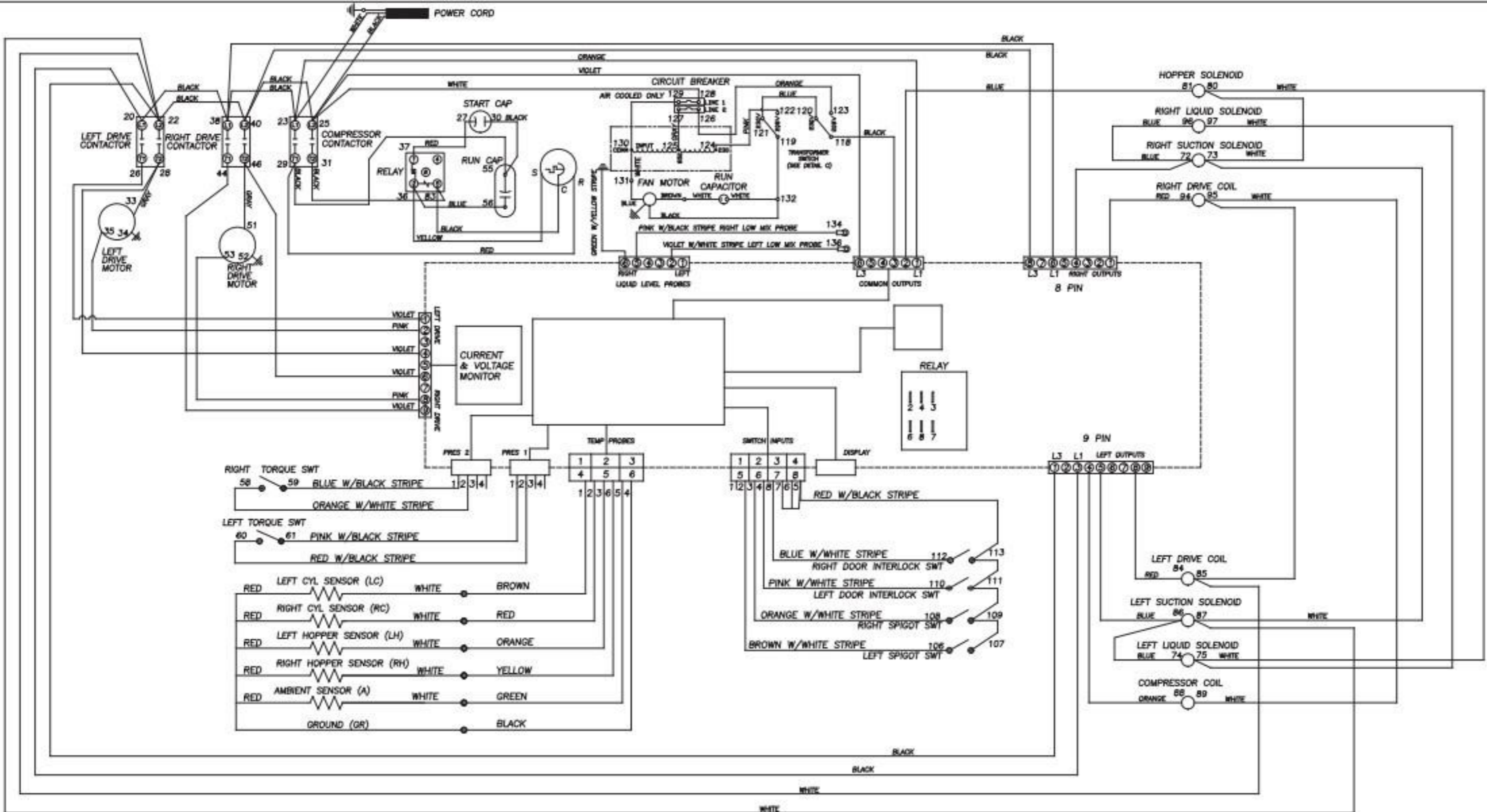

DRIVE MOTOR WIRING

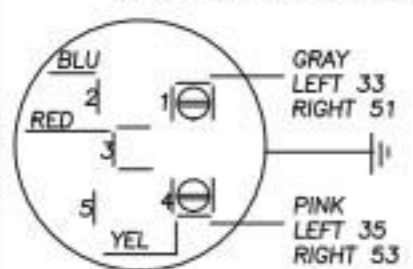

DRIVE MOTOR DETAILS
(SEE MOTOR LABEL FOR ADDITIONAL SIGNALS) POSITION OF PING SWIFT END

GRAY LEFT 33
 RIGHT 51

PINK LEFT 35
 RIGHT 53

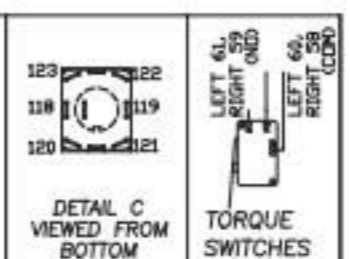
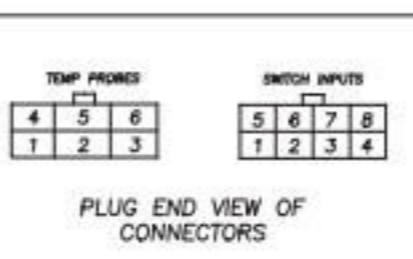
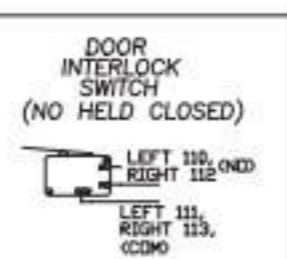
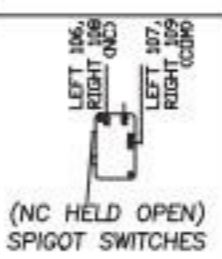

CAUTION
 DISCONNECT POWER SUPPLY BEFORE SERVICING

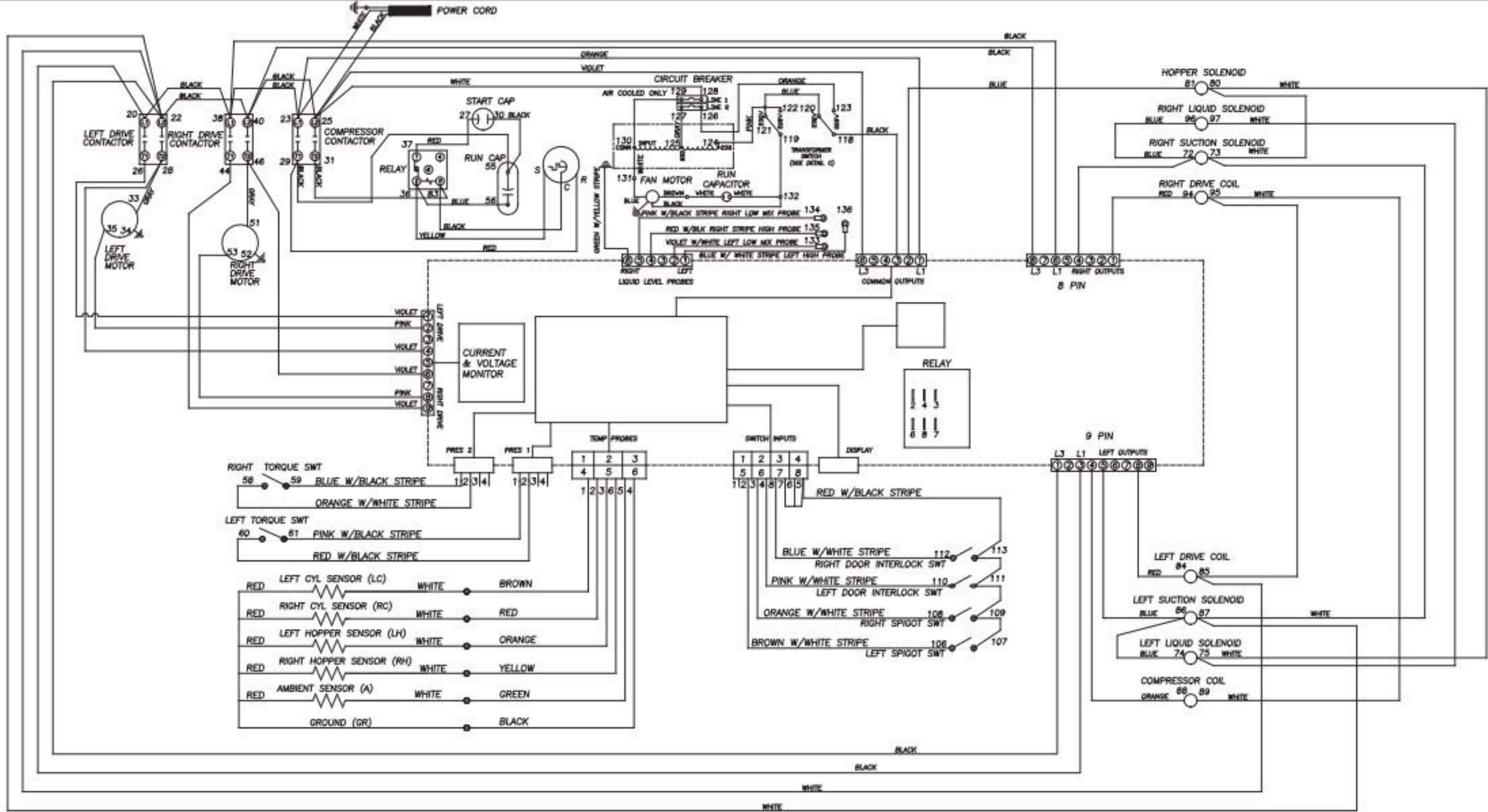

DRIVE MOTOR WIRING

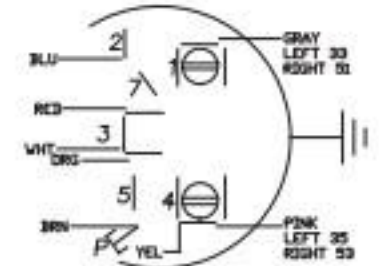

DRIVE MOTOR DETAIL
 USE MOTOR LABEL FOR ADDITIONAL DETAILED INFORMATION BY FACING SHAFT END

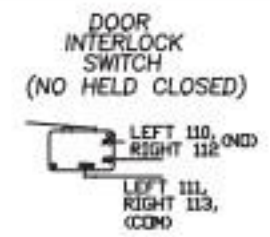
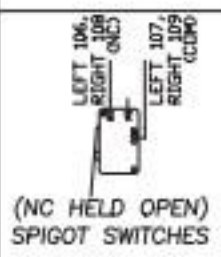

PLUG END VIEW OF CONNECTORS

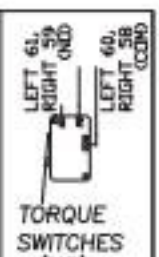

CAUTION
 DISCONNECT POWER SUPPLY BEFORE SERVICING

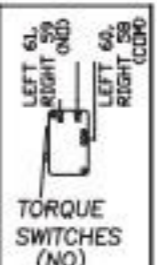
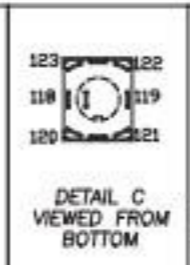
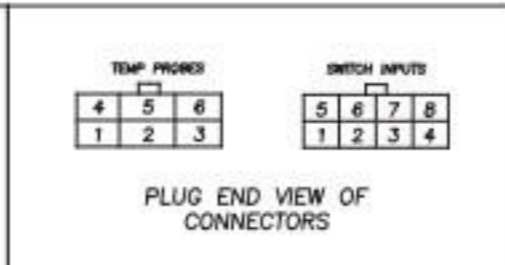
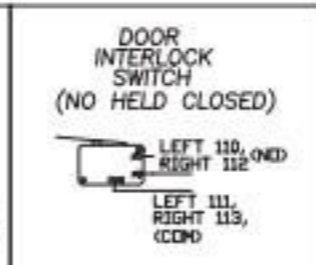
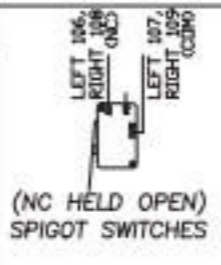
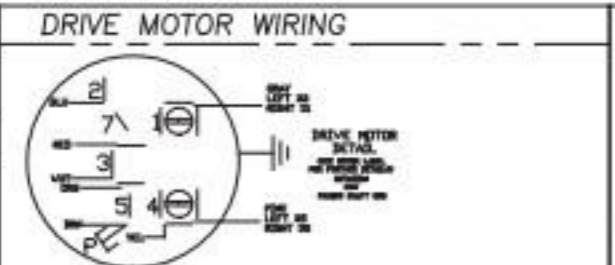
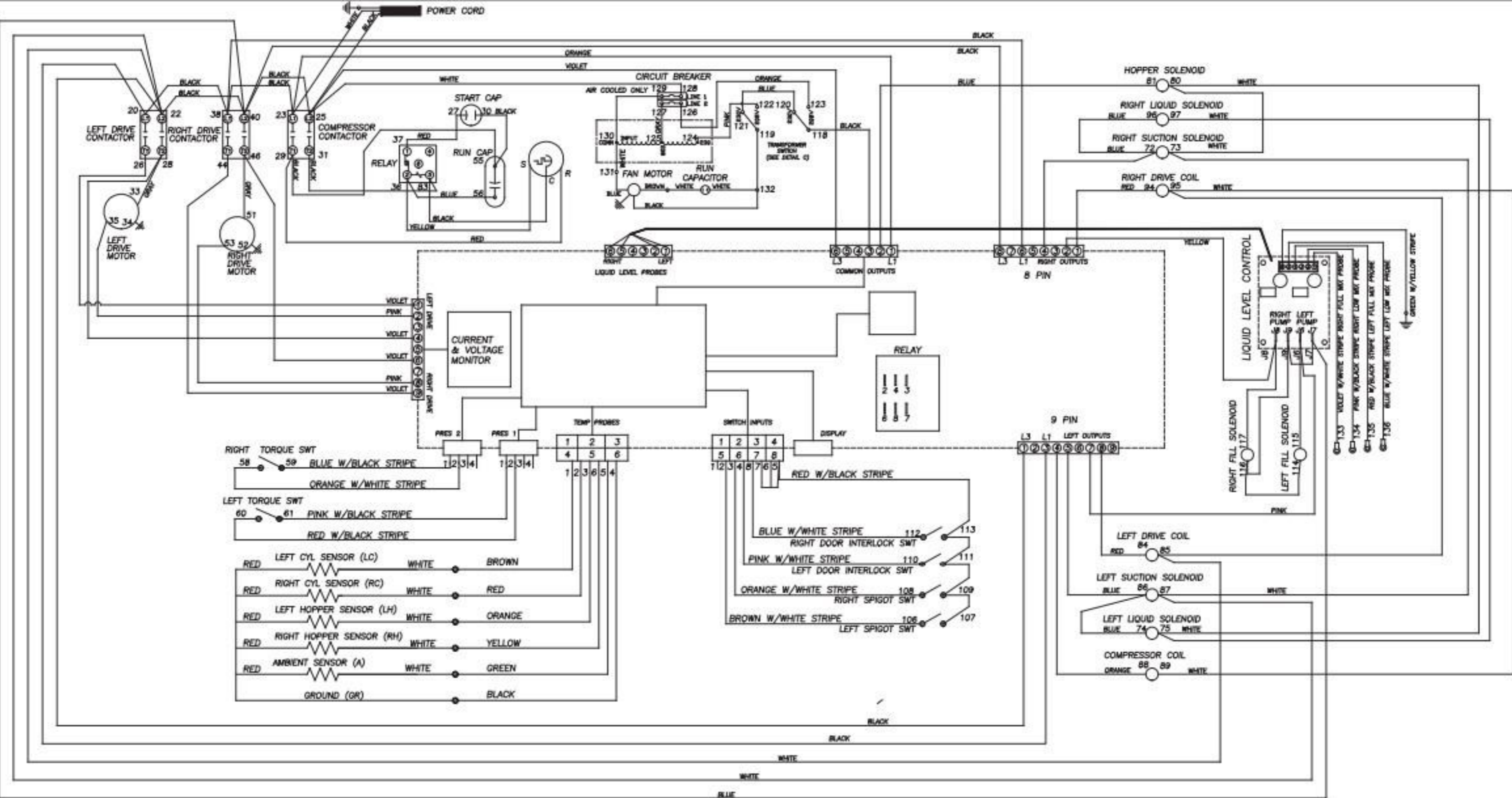

CAUTION
DISCONNECT POWER SUPPLY
BEFORE SERVICING

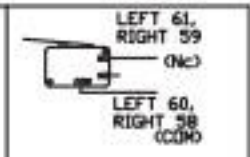
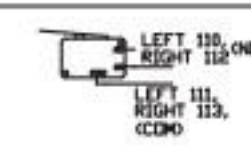
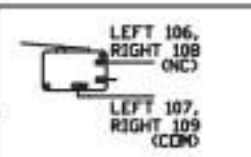
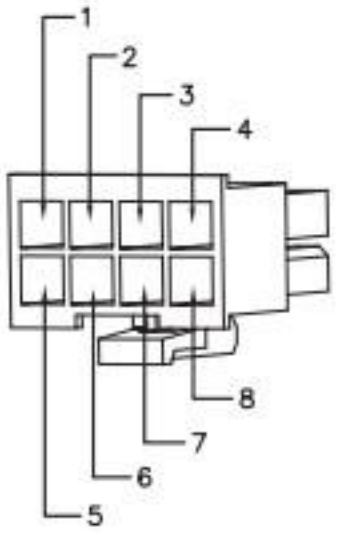
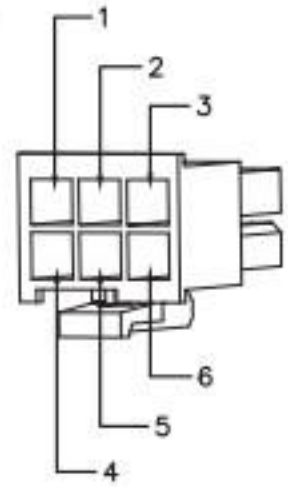
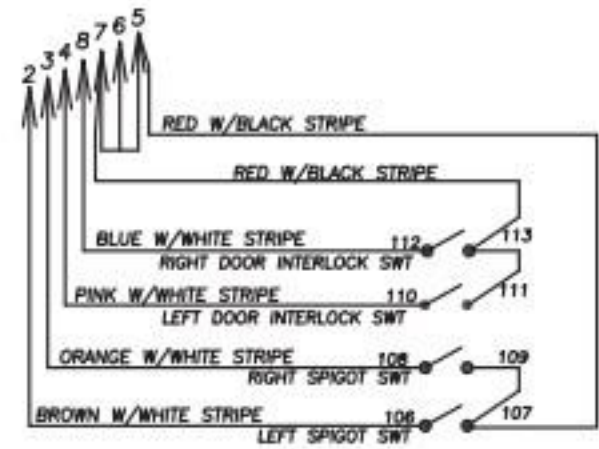
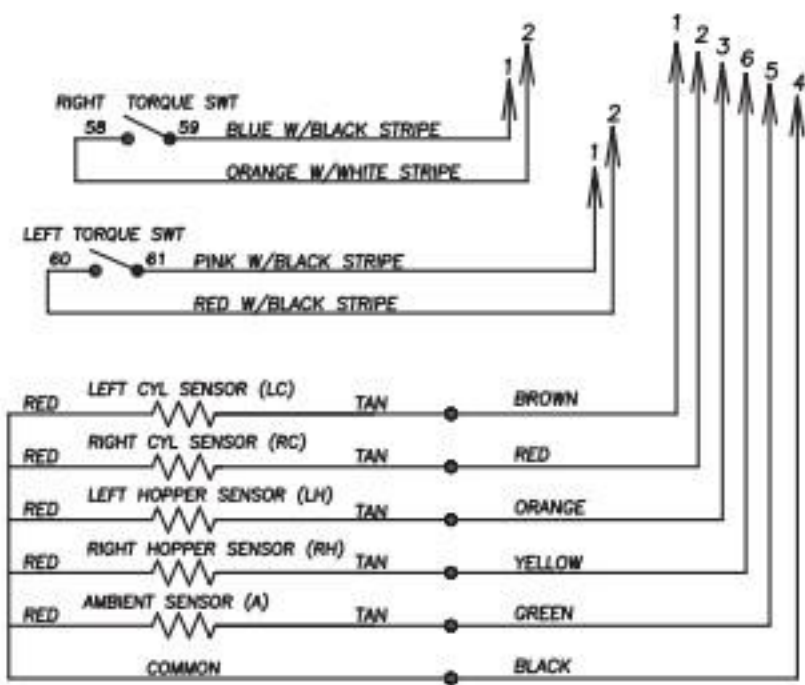
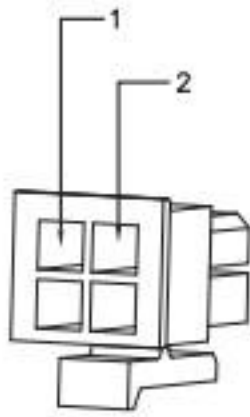
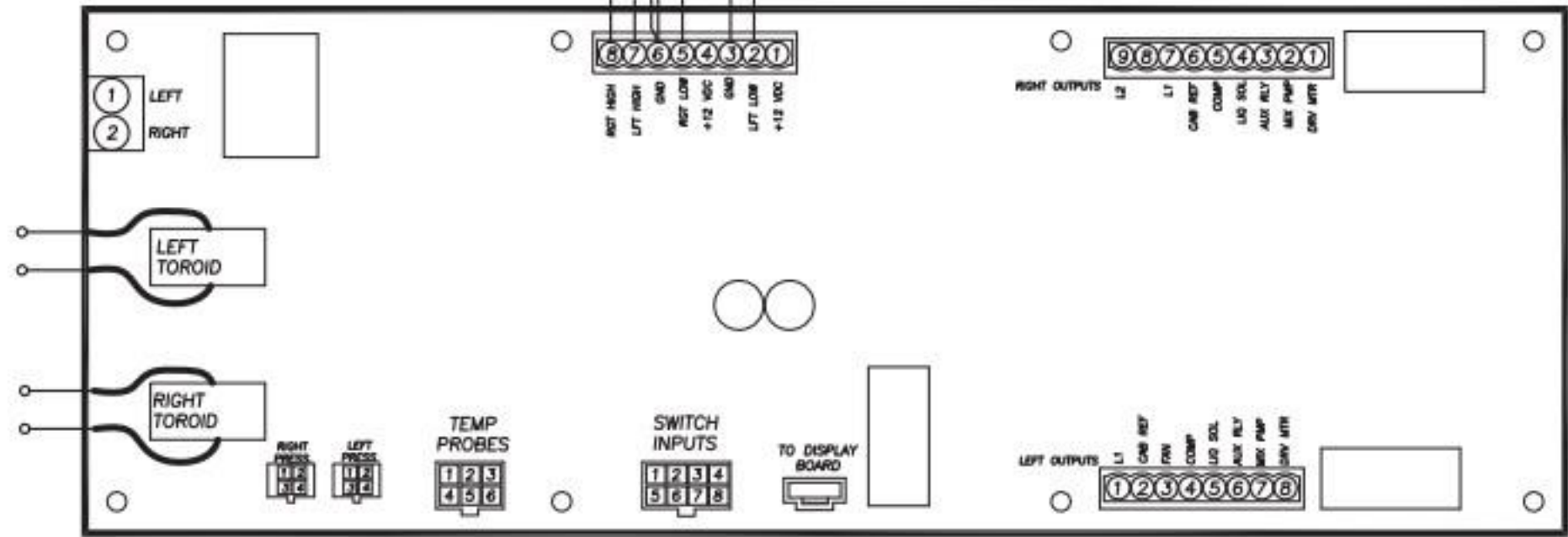
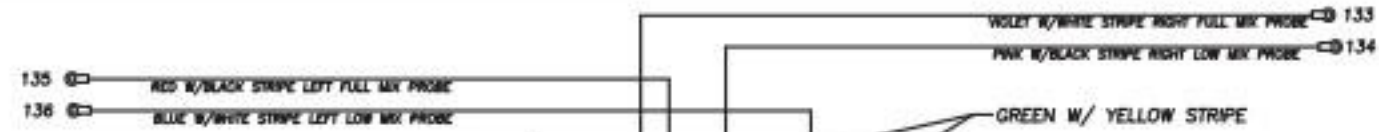

SPIGOT SWITCHES
(NC HELD OPEN)

DOOR INTERLOCK
SWITCH
(NO HELD CLOSED)

TORQUE
SWITCHES
(NC HELD OPEN)

E122-38I2 & E122-38I2P

CAUTION
DISCONNECT POWER SUPPLY
BEFORE SERVICING

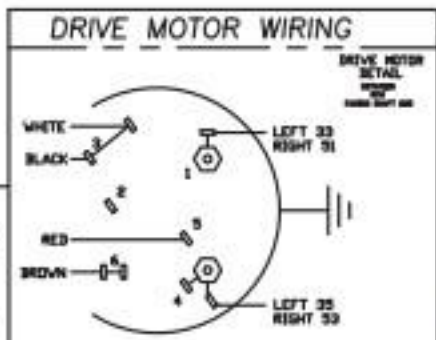
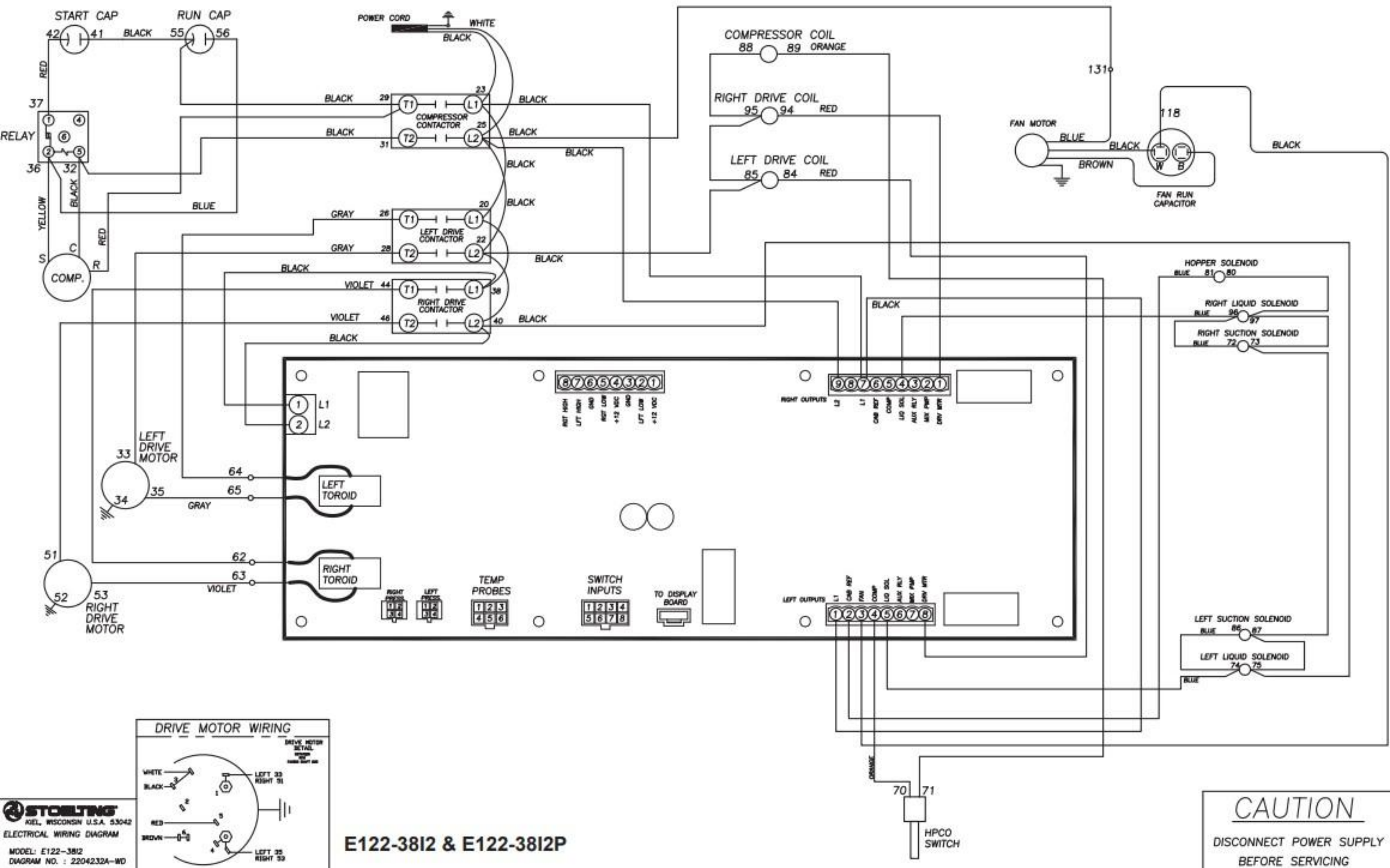

STOLING
 KIEL, WISCONSIN U.S.A. 53042
 ELECTRICAL WIRING DIAGRAM
 MODEL: E122-3812
 DIAGRAM NO.: 2204232A-WD

E122-3812 & E122-3812P

CAUTION
 DISCONNECT POWER SUPPLY
 BEFORE SERVICING

1.35 RED W/BLACK STRIPE LEFT FULL MIX PROBE
 1.36 BLUE W/WHITE STRIPE LEFT LOW MIX PROBE
 VIOLET W/WHITE STRIPE RIGHT FULL MIX PROBE 1.33
 PINK W/BLACK STRIPE RIGHT LOW MIX PROBE 1.34
 GREEN W/ YELLOW STRIPE

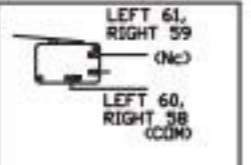
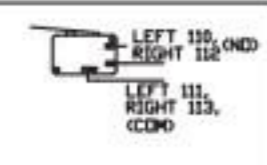
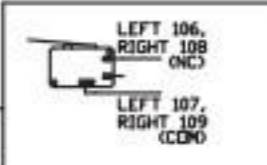
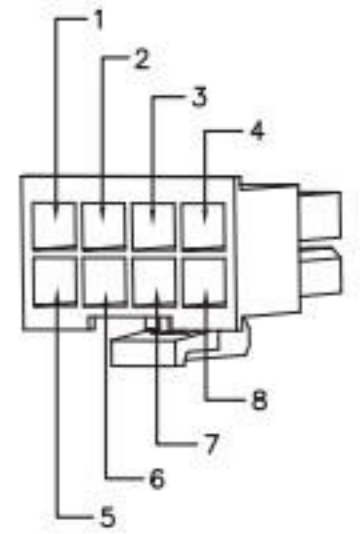
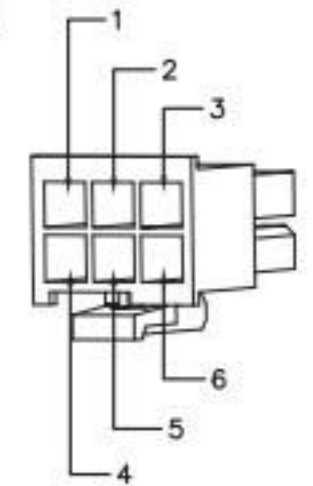
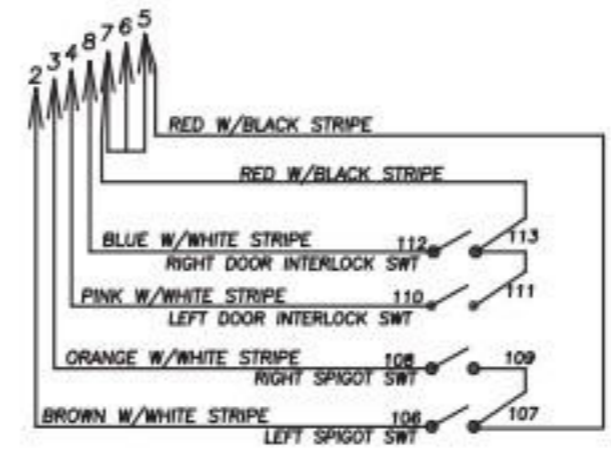
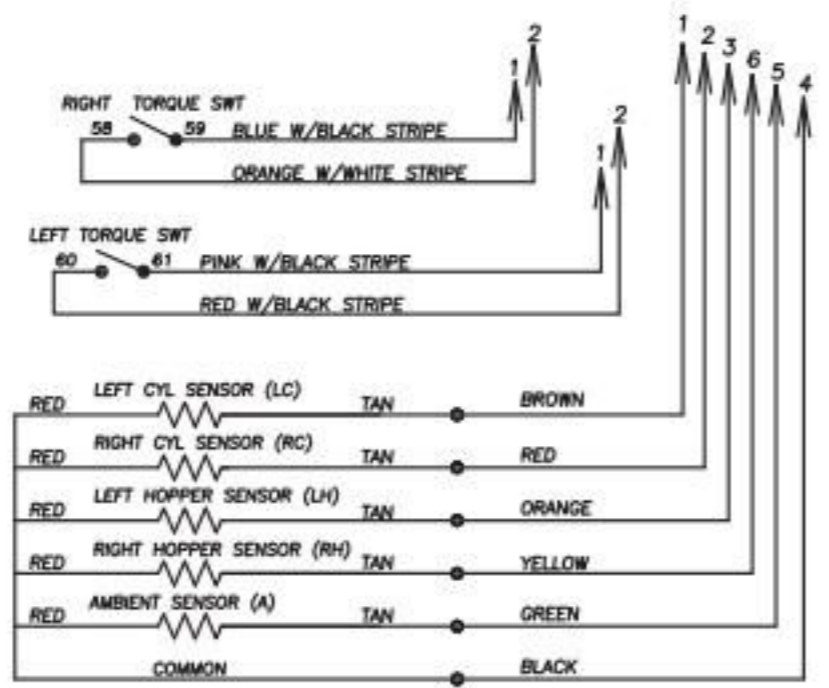
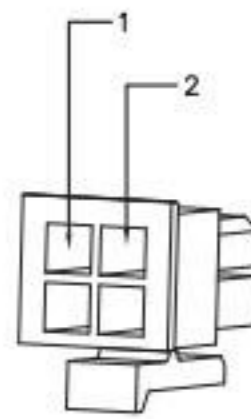
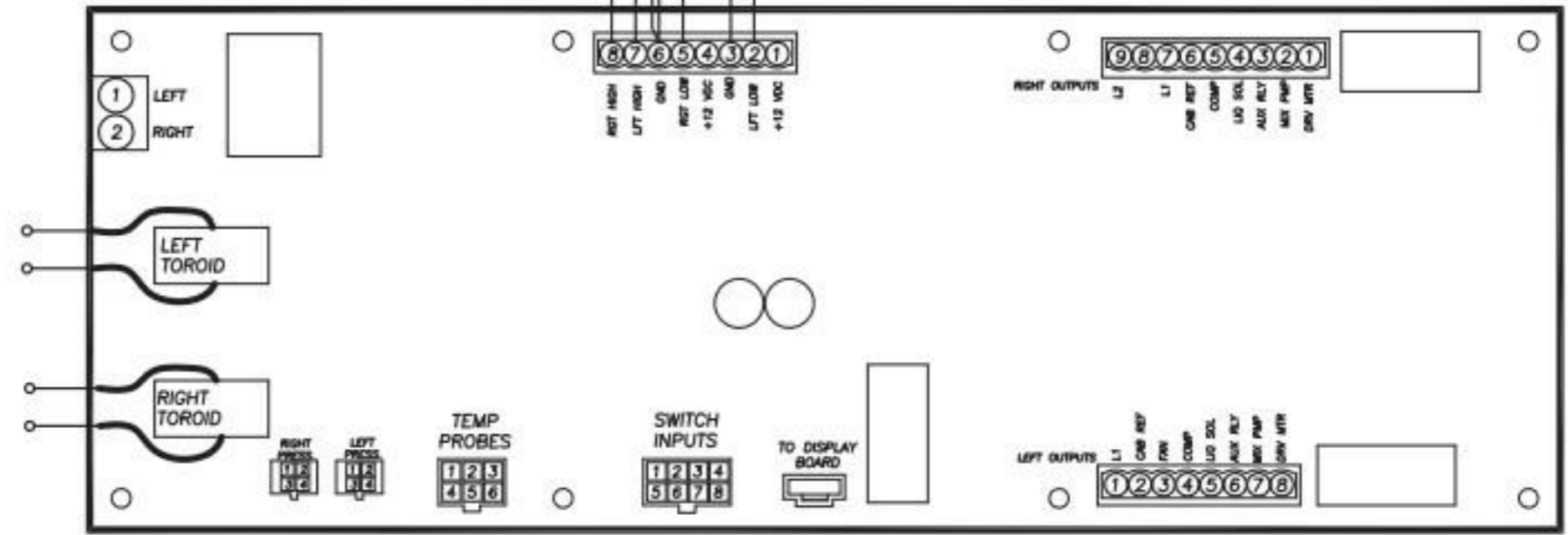

SPIGOT SWITCHES
(NC HELD OPEN)

DOOR INTERLOCK
SWITCH
(NO HELD CLOSED)

TORQUE
SWITCHES
(NC HELD OPEN)

E122-38I2AF

CAUTION
 DISCONNECT POWER SUPPLY
 BEFORE SERVICING

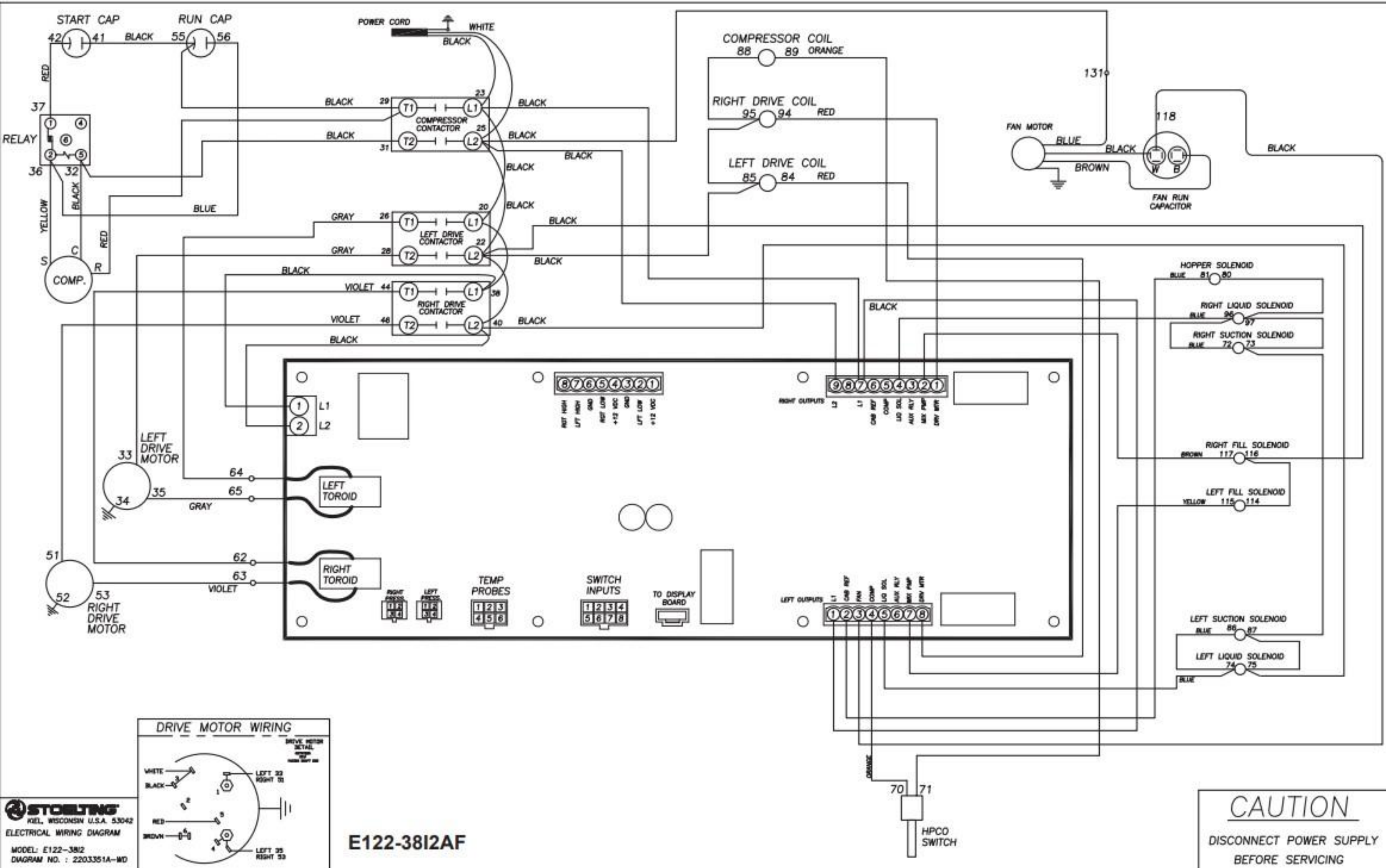

STORLING
 KIEL, WISCONSIN U.S.A. 53042
 ELECTRICAL WIRING DIAGRAM
 MODEL: E122-38I2
 DIAGRAM NO.: 2203351A-MD

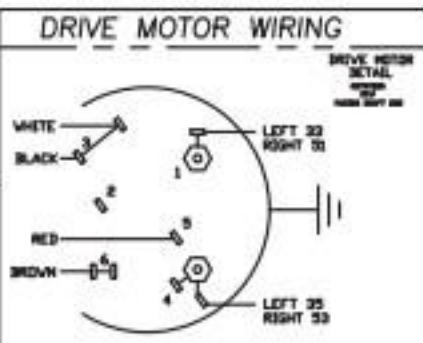

E122-38I2AF

CAUTION
 DISCONNECT POWER SUPPLY
 BEFORE SERVICING