



Model E131-I2 / F131-I2
OPERATOR'S MANUAL

Manual No. [513674](#)

V8

Operator's Manual

E131-I2 & F131-I2 GRAVITY FED TWIN TWIST COUNTERTOP MACHINES

SAFETY INFORMATION

This manual provides basic information about the safety, operation, and service of the machine. This manual follows the guidance set forth in the following industry standards: ANSI Z535.6, ASTM F760-93, ASTM F1827-13, and the FDA Food Code.

The illustrations and specifications in this manual are not binding in detail. Stoelting® Foodservice Equipment reserves the right to make changes to the machine without notice, and without incurring any obligation to modify or provide new parts for machines built prior to date of change.

DO NOT ATTEMPT to operate the machine until all instructions and safety precautions in this manual are read completely and are thoroughly understood. The installation and startup of this machine must be performed by a qualified technician. The warranty will be void if the machine is not installed correctly. For problems or questions with installation, operation, or servicing, contact Stoelting White Glove Service — 1.800.319.9549.

WARNING

“WARNING” indicates a potential hazard that can or will cause severe injury or death if not avoided.

CAUTION

“CAUTION” indicates a potential hazard that can cause minor or major injury if ignored.

“NOTICE” indicates equipment/property damage information. It is not hazard-related.

“NOTE” indicates additional information, usually a hint or tip, that is not hazard-related and does not involve equipment/property damage.

If you need to replace a part, use genuine Stoelting parts with the correct part number when possible. We strongly recommend that you do not use replacement parts of inferior quality.

For warranty information, visit www.stoeltingfoodservice.com.

TABLE OF CONTENTS

Section 1 - Description & Specifications

1.1	Description.....	1
1.2	Machine Models	1
1.3	Specifications	2

Section 2 - Installation Instructions

2.1	Safety Precautions	3
2.2	Shipment & Transit.....	3
2.3	Machine Installation.....	3
2.4	IntelliTec2® Setup.....	4

Section 3 - Initial Set-Up & Installation

3.1	Operator's Safety Precautions	7
3.2	Operating Controls & Indicators	7
3.3	Emptying the Freezing Cylinder.....	8
3.4	Disassembling Machine Parts	8
3.5	Cleaning Disassembled Parts	9
3.6	Assembling Machine	9
3.7	Sanitizing	10
3.8	Freezing Down & Operating.....	11
3.9	Mix Information	12

Section 4 - Maintenance & Adjustments

4.1	Fine Consistency Adjustment	13
4.2	Preventive Maintenance.....	13
4.3	Extended Storage	13

Section 5 - Troubleshooting

5.1	Error Codes.....	15
5.2	Troubleshooting Error Codes.....	15
5.3	Troubleshooting Machine	17

Section 6 - Replacement Parts

6.1	Decals & Lubrication.....	19
6.2	Auger & Front Door	20
6.3	Trays & Hopper Cover.....	21

Section 1 - Description & Specifications

1.1 DESCRIPTION

The Stoelting® E131-I2 and F131-I2 counter-top machines are gravity fed. The machines are equipped with the IntelliTec2® control which provides a uniform product. The machines are designed to operate with almost any type of commercial soft serve or non-dairy mixes available, including: ice milk, ice cream, yogurt, and frozen dietary desserts.

This manual is designed to assist qualified service personnel and operators in the installation, operation and maintenance of the Stoelting E131-I2 and F131-I2 gravity machines.

1.2 MACHINE MODELS

This manual applies to the following models:

- E131-38I2
- E131-18I2
- E131-309I2
- E131-109I2
- E131-38I2YG2
- E131-309I2YG2
- E131-109I2YG2
- E131-38I2-WF
- E131X-102I2
- E131X-302I2
- E131X-314I2
- E131X-314I2-WF
- E131-38I2YG2-TCBY
- F131-38I2
- F131-18I2
- F131-38I2-YG2
- F131-309I2
- F131-18I2-YG2
- F131-109I2
- F131-38I2-WF
- F131X-102I2
- F131X-302I2
- F131X-302I2-WF
- F131X-314I2
- F131X-314I2-WF
- F131-18I2-WF
- F131-309I2-WF
- F131X-302I2-GP



Figure 1-1 Model F131-I2



Figure 1-2 Dimensions

1.3 SPECIFICATIONS

Model E131-I2		
Dimensions	Machine	with crate
width	22" (55,9 cm)	28" (71,1 cm)
height	34-3/4" (88,3 cm)	40-1/4" (102,2 cm)
depth	28-1/2" (72,4 cm)	35-1/4" (89,5 cm)
Weight	370 lbs (167,8 kg)	450 lbs (204,1 kg)
Electrical	1 Phase, 208-240 VAC, 60Hz	3 Phase, 208-240 VAC, 60Hz
running amps	12A	10A
connection type	NEMA6-20P power cord provided	NEMA L15-20P power cord provided
International Option	1 Phase, 220-240 VAC, 50Hz	
Compressor	8,600 Btu/hr	
Drive Motor	Two - 3/4 hp	
Air Flow	Air cooled units require 3" (7,6 cm) air space on both sides	
Plumbing Fittings	Water cooled units require 3/8" N.P.T. water and drain fittings. Maximum water pressure of 130 psi. Minimum water flow rate of 3 GPM. Ideal EWT of 50°-70°F.	
Hopper Volume	Two - 3 gallon (11,35 liters)	
Freezing Cylinder Volume	Two - 0.65 gallon (2,46 liters)	

Model F131-I2		
Dimensions	Machine	with crate
width	22" (55,9 cm)	28" (71,1 cm)
height	34-3/4" (88,3 cm)	40-1/4" (102,2 cm)
depth	28-1/2" (72,4 cm)	35-1/4" (89,5 cm)
Weight	385 lbs (174,6 kg)	450 lbs (204,1 kg)
Electrical	1 Phase, 208-240 VAC, 60Hz	3 Phase, 208-240 VAC, 60Hz
running amps	12A Air-Cooled / 11A Water-Cooled	10A
connection type	NEMA6-20P power cord provided	NEMA L15-20P power cord provided
International Option	1 Phase, 220-240 VAC, 50Hz	
Compressor	12,000 Btu/hr	
Drive Motor	Two - 3/4 hp	
Air Flow	Air cooled units require 3" (7,6 cm) air space on both sides	
Plumbing Fittings	Water cooled units require 3/8" N.P.T. water and drain fittings. Maximum water pressure of 130 psi. Minimum water flow rate of 3 GPM. Ideal EWT of 50°-70°F.	
Hopper Volume	Two - 3 gallon (11,35 liters)	
Freezing Cylinder Volume	Two - 0.85 gallon (3,22 liters)	

Section 2 - Installation Instructions

2.1 SAFETY PRECAUTIONS

Do not attempt to operate the machine until the safety precautions and operating instructions in this manual are read completely and are thoroughly understood.

Take notice of all warning labels on the machine. The labels have been put there to help maintain a safe working environment. The labels have been designed to withstand washing and cleaning. All labels must remain legible for the life of the machine. Labels should be checked periodically to be sure they can be recognized as warning labels.

If danger, warning or caution labels are needed, indicate the part number, type of label, location of label, and quantity required along with your address and mail to:

Stoelting Foodservice Equipment
502 Hwy. 67
Kiel, Wisconsin 53042

2.2 SHIPMENT & TRANSIT

The machine has been assembled, operated and inspected at the factory. Upon arrival at the final destination, the entire machine must be checked for any damage which may have occurred during transit.

With the method of packaging used, the machine should arrive in excellent condition. **THE CARRIER IS RESPONSIBLE FOR ALL DAMAGE IN TRANSIT, WHETHER VISIBLE OR CONCEALED.** Do not pay the freight bill until the machine has been checked for damage. Have the carrier note any visible damage on the freight bill. If concealed damage and/or shortage is found later, advise the carrier within 10 days and request inspection. The customer must place claim for damages and/or shortages in shipment with the carrier. Stoelting cannot make any claims against the carrier.

2.3 MACHINE INSTALLATION



WARNING

Installation must be completed by a qualified electrician/refrigeration specialist.

Incorrect installation may cause personal injury, severe damage to the machine and will void factory warranty.

Installation of the machine involves moving the machine close to its permanent location, removing all crating, setting in place, assembling parts, and cleaning.

A. TOOLS NEEDED

- Level
- Screwdrivers and wrenches
- Straight edge
- Thermometer
- Stopwatch
- Belt tension guide
- Scale
- Refrigeration gauges

B. PRIOR TO INSTALLATION

1. On the startup form, complete the following:
 - Buyer Information
 - Distributor Information
 - Authorized Service Provider Information
 - Verify with Store Operator Checklist
 - Freezer Configuration Information
2. Prepare a USB flash drive with your service contact information:
 - a. Locate a copy of the service contact file (info.txt).
 - b. Modify the info.txt file with information from the service company using the instructions in the file.
 - c. Put the service contact file onto the root level of a USB flash drive (do not put the files into any folder).

C. INSTALLATION

1. Uncrate the machine and remove the 3/8" bolts holding it to the pallet.
2. Install the legs. Loosen the lock nut and screw the legs into the base of the machine to a height of about 3/4". Set the machine in place.
3. Accurate leveling is necessary for correct drainage of the freezing cylinder and to ensure correct overrun. Place a bubble level on top of the machine at each corner to check for level condition. If adjustment is necessary, level the machine by turning the bottom part of each leg in or out then tighten the lock nut.
4. The machine has a base gasket that must be installed. Install the gasket with the seam to the back. Make sure the angled side of the gasket is facing up.

- In air cooled machines correct ventilation is required. The right side of the machine is the air intake and left side is the discharge. Both sides must have 3” clearance.

 CAUTION
Failure to provide adequate ventilation will void warranty.

In water cooled machines, make sure to use 1/2” supply and discharge lines. Follow all local and state codes for connecting the supply and discharge lines. Turn on the water supply and check all connections for leaks.

- Open the rear panel and check the belt tension with a Burroughs Belt Tension Gauge. The tension should be 50-58 lbs. Adjust as necessary and check the pulley alignment with a straightedge.

NOTE

Belt life will be increased if the new drive belts are tightened after two or three weeks of operation.

- Connect the power cord to the proper power supply. Refer to the nameplate on your machine for proper supply. The unit must be connected to a properly grounded receptacle. The use of an extension cord is not recommended. Do not use an adapter to circumvent the grounding requirement.

 WARNING
Do not alter or deform the electrical plug in any way. Altering the plug to fit into an outlet of different configuration may cause fire, risk of electrical shock, product damage and will void warranty.

- On the startup form, complete the following:
 - Technical Equipment Inspection, Check-Out, Startup and Training Checklist (excluding IntelliTec2® checks)
 - Refrigeration Cooling Checks

2.4 INTELLITEC2® SETUP

- Disassemble, clean, lubricate and assemble the machine following the steps in Section 3. Train store personnel at this time.
- On the startup form, complete the following:
 - Owner/Operator Manual Review & Equipment Training
 - Startup Operational/Technical Issues
 - Trainee Information
 - Startup Survey
 - Equipment Startup & Training Check Out & Acceptance
- Fill the hoppers with 2 gallons of sanitizer.

A. MOTOR CALIBRATION

Before starting the motor calibration, be sure there is sanitizer in the freezing cylinders.

- Press the On/Off Left or On/Off Right button. The Motor Calibration screen will be displayed.

Motor Calibration	
_ Left Press Sel to Start	
Current Zero Load	00 W
_ Right Press Sel to Start	
Current Zero Load	00 W
Calibration Required	Off

- Move the cursor over the Left side and press the SEL button then move the cursor over the Right side and press the SEL button.

NOTE

The motor calibration can be done for both sides simultaneously.

- Brush the hopper sides and cover with a clean sanitized brush.
- After the calibration is complete, record the information in the startup form and then press the left arrow button.
- Drain the machine of sanitizer.

B. SETTING CONTACT INFORMATION (OPTIONAL)

- Plug your USB flash drive into the port located behind the protective cap on the right side of the machine.

NOTE

The service contact information must be in the info.txt file on the root level of the drive.

- From the Current Status screen, press the left arrow button to access the passcode selection screen. Press the right arrow, SET, and then the SEL button.

- After the password is accepted, use the arrows to move the cursor to the Modify Settings option and press the SEL button. Then move the cursor to the User Preferences and press the SEL button.

```

Modify Operating Settings
_ Reset Serve Amount
_ Basic Settings
_ Advanced Settings
_ Storage Settings
_ User Preferences
_ Time and Date

```

- On the User Preferences screen move the cursor to the Contact Information USB Update and press the SEL button.

```

User Preferences
_ Language English
_ Temp Units Fahrenheit(°F)
_ Service Contact Information
_ Contact Information USB Update
_ Samples Served Information
_ SSID Information USB Update
_ Pass Key USB Update

```

- The screen will change and show “File Found” for a quick second while it updates the information.
- After updating the contact information, the screen will show the Service Contact Information page.

```

Service Contact Information
Name
  Stoelting
Telephone Number
  920 - 894 - 2293
Unit Serial Number
  00000000
Version 00.00/00.00

```

- Press the left arrow button to go back to the Current Status screen and remove the USB flash drive and install the protective cap over the USB port.

C. SETTING TIME & DATE

- Press the right arrow button.
- Move the cursor to the Modify Settings option and press the SEL button. Then move the cursor to the Time and Date option and press the SEL button and adjust the settings as required.
 - Press the SEL button to enter the Modify Time and Date screen.
 - Move the cursor up or down to the setting that needs to be changed and press the SET button.
 - Use the arrow buttons to change the setting and press the SET button to save the change.

```

Time and Date

Time 00:00:00 AM
Date 00/00/00
Daylight Savings Off
Clock Type 12 HR
Date Format
_ Modify Time and Date

```

- Press the left arrow button until the Current Status screen is displayed.

D. SETTING CONSISTENCY

On water cooled machines, connect refrigeration gauges to the suction and discharge lines. Check the suction and discharge pressures as the machine cycles.

- Install the carburetor.
- Fill the hopper with liquid mix. Immediately after filling the hopper, open the spigot to drain any remaining sanitizer.
- After the freezing cylinder stops filling, turn on the freezing cylinder and press the Push to Freeze button.
- Water cooled machines require the water condenser valves to be adjusted to maintain a 225-235 psig discharge pressure.
- Draw product from the barrel immediately after the compressor cycles off and test the product for consistency and temperature.

6. Adjust the product consistency by increasing or decreasing the Consist Offset settings. These settings are under the Modify Settings - Basic Settings menu. Adjust the settings as follows:
 - If the product is too soft, increase the Cutln Consist Offset.
 - If the product is too firm, decrease the Cutln Consist Offset.

NOTE

Make adjustments in increments of 2 for best results. After adjusting, wait for the compressor to cycle before testing again.

7. After the consistency is set, record the values on the startup form.
8. To exit the settings screen on the IntelliTec2®, press the left arrow button once so that the Modify Operating Settings screen is displayed.

E. SETTING SERVE TIME & OVERRUN DETAILS

1. Go to the Advanced Settings (2 of 2) screen and scroll down to the Time to Dispense 16 oz option.
2. Time how long it takes to dispense 16 oz of product into a cup and change the value in the control.
3. Measure to overrun of the product and change the value in the control. To measure overrun, do the following:
 - a. Zero a scale with an 8 - 16 oz cup.
 - b. Fill the cup with liquid mix and weigh it. Make sure the mix is filled to the rim.
 - c. Fill the cup with frozen product. Make sure there are no voids (air pockets) when filling.

NOTE

If installed, remove the rosette cap for this test.

- d. Scrape the top of the cup with a straight edge.
- e. Weigh the filled cup.
- f. Calculate the overrun using the following equation:

$$\frac{\text{Liquid Weight} - \text{Frozen Weight}}{\text{Frozen Weight}} \times 100 = \% \text{Overrun}$$

4. Go to the Advanced Settings (2 of 2) and change the value in the control. Record the overrun on the startup form.
5. Press the left arrow button until the Current Status screen is displayed.

The startup is completed and the machine is ready to serve.

Section 3 - Initial Set-Up & Installation

3.1 OPERATOR'S SAFETY PRECAUTIONS

SAFE OPERATION IS NO ACCIDENT; observe these rules:

1. Know the machine. Read and understand the Operating Instructions.
2. Notice all warning labels on the machine.
3. Wear proper clothing. Avoid loose fitting garments, and remove watches, rings or jewelry that could cause a serious accident.
4. Maintain a clean work area. Avoid accidents by cleaning up the area and keeping it clean.
5. Stay alert at all times. Know which switch, push button or control you are about to use and what effect it is going to have.
6. Disconnect power for maintenance. Never attempt to repair or perform maintenance on the machine until the main electrical power has been disconnected.
7. Do not operate under unsafe operating conditions. Never operate the machine if unusual or excessive noise or vibration occurs.

3.2 OPERATING CONTROLS & INDICATORS

Before operating the machine, it is required that the operator know the function of each operating control. Refer to Figure 3-1 for the location of the operating controls on the machine.



WARNING

Hazardous Voltage

The display must show that the freezing cylinder is off prior to disassembling for cleaning or servicing. If it is not, press the On/Off button to turn it off prior to disassembling for cleaning or servicing. Do not operate the machine with the panels removed.

A. INTELLITEC2® CONTROL

The Main Power button is used to supply power to the IntelliTec2 control, the freezing cylinder circuits and the storage refrigeration system. When the machine is first plugged in, the control defaults to the On status with power only to the hopper. If the Main Power On/Off button is pressed and held for 3 seconds, the machine turns off and a status message is displayed on the screen.



Figure 3-1 Controls



Figure 3-2 IntelliTec2® Control

Help

Pressing the Help button displays help information dependent on the cursor's location. Pressing the Help button again exits the help screen.

Selection Button (SEL)

The SEL button is used by technicians to select menu options.

Set Button (SET)

The SET button is used by technicians to save changes when modifying control settings.

On/Off Button

Power to the freezing cylinders can then be controlled with the On/Off button.

Push to Freeze Button

Pressing the PUSH TO FREEZE button initiates "Serve Mode".

Clean Button

The CLEAN button initiates "Clean Mode".

Arrow Buttons (→, ↓, ←, ↑)

The arrow buttons are used by technicians to navigate through the control readings and settings.

Dispense Rate Adjustor

The dispense rate adjustor is located under the header panel, to the immediate right of the spigot handles. Turning the knob to the right decreases the dispense rate.

USB Access Port

The USB access port is located on the right side panel of the machine. The port is used by technicians to import firmware and export machine statistics.

3.3 EMPTYING THE FREEZING CYLINDER

If the machine is empty, go to Section 3.4.

1. Make sure the Main Freezer Power is on. If the IntelliTec2 displays the Current Status Screen, then the main power is on.
2. Turn off the freezing cylinder by pressing the On/Off button
3. Remove the hopper cover and remove the carburetor from the hopper.

4. Press the Clean button. After about 5 minutes open the spigot to drain the mix.
5. Press the Clean button to stop the auger.
6. Fill the hopper with 2 gallons (8 liters) of cool tap water. Optional: Use detergent solution instead of tap water to make cleaning the parts easier after disassembly.
7. Press the Clean button and let the auger rotate for at least 30 seconds.
8. While the auger is rotating, scrub the hopper with a clean brush.
9. Drain the water out of the machine.
10. Press the Clean button to stop the auger.

NOTE

If the water does not drain clear, repeat step 6 through 10.

3.4 DISASSEMBLING MACHINE PARTS

Before using the machine for the first time, complete machine disassembly, cleaning, and sanitizing procedures need to be followed. Routine cleaning intervals and procedures must comply with the local and state health regulations. Inspection for worn or broken parts should be made at every disassembly of the machine. All worn or broken parts should be replaced to ensure safety to both the operator and the customer and to maintain good machine performance and a quality product. Check the wear line on the auger flights on a regular basis and replace as needed.



Figure 3-3 Auger Flight Wear

To disassemble the machine, refer to the following steps:

A. DISASSEMBLY OF FRONT DOOR

1. Press and hold the Main Freezer Power button for three seconds to turn the power off.
2. Remove the rosette caps or spigot extensions if installed.
3. Remove the knobs on the front door.
4. Remove the front door by pulling it off the studs.
5. Remove the spigot through the bottom of the front door.

- Remove all o-rings from parts by first wiping off the lubricant using a clean towel. Then squeeze the o-ring upward to form a loop. Roll the o-ring out of the groove.

 CAUTION
<p>Do not use any type of sharp object to remove the o-rings. Damaging the o-rings may cause leaking.</p>



Figure 3-4 Removing O-Ring

- Wipe any excess lubricant from all o-rings and parts before washing.

B. DISASSEMBLING AUGER

- Remove the front auger support and bushing.
- Remove the auger assembly from the machine. Pull the auger out of the freezing cylinder slowly. As the auger is being pulled out, carefully remove each of the plastic flights with springs.
- Keep the rear of the auger tipped up once it is clear of the freezing cylinder to prevent the rear seal assembly from dropping.
- Wipe the lubricant off of the hex end of the auger with a paper towel. Remove the rear seal assembly.

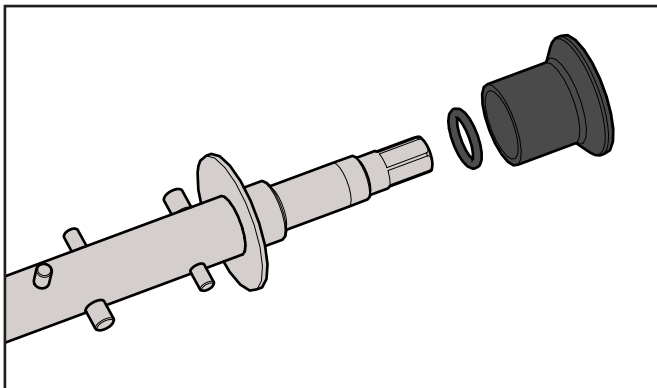

Figure 3-5 Rear Seal Assembly

- Wipe any excess lubricant off the rear seal.
- Unscrew the springs from the auger flights.

3.5 CLEANING DISASSEMBLED PARTS

Disassembled parts require complete cleaning, sanitizing and air drying before assembling. Local and state health codes dictate the procedure required. Some state health codes require a four sink process (pre-wash, wash, rinse, sanitize, air dry), while others require a three sink process (without the pre-wash step). The following procedures are a general guideline only. Consult your local and state health codes for the procedures required in your location.

- Disassemble all parts. (Refer to Section 3.4 for the disassembly of machine parts)
- Place all parts in 90° to 110°F (32°C to 43°C) mild detergent water and wash thoroughly. Use the brushes that shipped with the machine to clean all holes in the front door, flights, mix pickup assembly, etc.
- Rinse all parts with clean 90° to 110°F (32°C to 43°C) water.
- Place all parts in a sanitizing solution for at least 1 minute, then remove and let air dry completely before assembling in machine.

A. CLEANING THE MACHINE

Interior

Using detergent solution and the large barrel brush provided, clean the hoppers and freezing cylinders.

NOTE

Make sure to thoroughly clean the rear seal surfaces on the inside of the freezing cylinders.

Wrap the brush in a clean cloth and thoroughly dry the hoppers and freezing cylinders.

Remove the drip tray and drain tray. Clean and replace the trays.

Exterior

The exterior should be kept clean at all times to preserve the luster of the stainless steel. A high grade of stainless steel has been used on the machine to ease cleanup. To remove spilled or dried mix, wash the exterior with 90° to 110°F (32°C to 43°C) mild detergent water and wipe dry.

Do not use highly abrasive materials, as they will mar the finish. Use a soft cloth or sponge to apply the solution. For best results, wipe with the grain of the steel.

3.6 ASSEMBLING MACHINE

To assemble the machine parts, refer to the following steps. Repeat for each freezing cylinder.

NOTICE

Total Blend sanitary lubricant or equivalent must be used when lubrication of machine parts is specified.

Do not use more than one packet of Total Blend per freezing cylinder.

NOTICE

The United States Department of Agriculture and the Food and Drug Administration require that lubricants used on food processing equipment be certified for this use. Use lubricants only in accordance with the manufacturer's instructions.

A. ASSEMBLING REAR SEAL

1. Install the rear seal o-ring onto the auger. Lubricate the outside of the o-ring with a generous amount Total Blend lubricant.
2. Lubricate the inside metal surface of the rear seal and install it onto the auger shaft. DO NOT lubricate the outside of the rear auger seal.

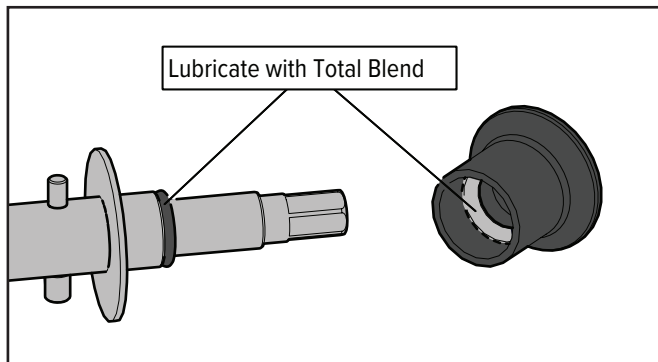

Figure 3-6 Lubricate Rear Seal

3. Lubricate the hex drive end of the auger with a small amount of Total Blend lubricant.

B. ASSEMBLING AUGER

1. Screw the springs onto the studs in the plastic flights. The springs must be screwed into the flights completely to provide proper compression.
2. Install the two plastic flights onto the rear of the auger and insert it part way into the freezing cylinder.



Figure 3-7 Inserting Auger

3. Install the remaining plastic flights, push the auger into the freezing cylinder and rotate slowly until the auger engages the drive shaft.
4. Apply a thin layer of sanitary lubricant to the inside and outside of the auger support bushing. Install the bushing onto the auger support and install the auger support into the front of the auger. Rotate the auger support so that one leg of the support points straight up.

C. ASSEMBLING FRONT DOOR

1. Install the o-rings onto the spigot bodies and apply a thin layer of sanitary lubricant to the o-rings. Install the spigot bodies through the bottom of the front door.
2. Fit the front door o-rings into the grooves on the rear of the front door.



Figure 3-8 Install Front Door O-Rings

3. Place the front door assembly on the mounting studs and the push front door against the machine carefully.

NOTE

Make sure the pin of the front door do not touch the legs of the auger support.

4. Secure the front door to the machine by placing the knobs on the studs and tightening until finger tight. Proper o-ring seal can be observed through the transparent front door.
5. Optional: Install the rosette caps or spigot extensions.

3.7 SANITIZING

Sanitizing must be done after the machine is clean and just before the machine is filled with mix. Sanitizing the night before does not ensure sanitization the next day. However, you should always clean the machine and parts after using it.

NOTE

The United States Department of Agriculture and the Food and Drug Administration require that all cleaning and sanitizing solutions used with food processing equipment be certified for this use.

When sanitizing the machine, refer to local sanitary regulations for applicable codes and recommended sanitizing products and procedures. The frequency of sanitizing must comply with local health regulations. Mix sanitizer in quantities of no less than 2 gallons of 90°F to 110°F (32°C to 43°C) water. Allow sanitizer to contact the surfaces to be sanitized for 5 minutes. Any sanitizer must be used only in accordance with the manufacturer's instructions and provide a 100 parts per million strength solution.

1. Prepare 2 gallons of Stera-Sheen sanitizing solution following the manufacturer's instructions.
2. Place the carburetors into the hoppers. Do not install them yet.
3. Pour the sanitizing solution into the hoppers.
4. Press the Main Power button, then press the CLEAN buttons.
5. Check for leaks.
 - a. Check for leaks at the front door seal.
 - b. Check the drain tray located under the front door for leaks coming from the rear of the rear auger seal.
6. Use a sanitized soft bristle brush dipped in sanitizing solution to clean the sides of the hoppers, the carburetors, and the undersides of the hopper covers.
7. After the five minute timer expires, open the spigots to drain the sanitizing solution.
8. Press the CLEAN buttons to stop the augers. Allow the freezing cylinder to drain completely.
9. Install the carburetors.

NOTE

Do not twist the carburetor when installing.

- Standard Carburetor: install with the air tube towards the front of the machine.

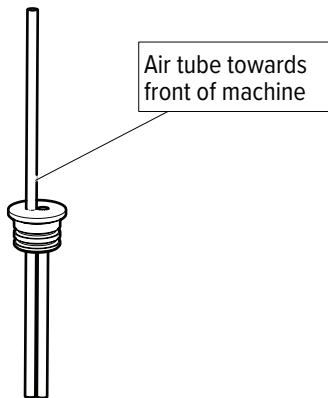

Figure 3-9 Standard Carburetor

- Adjustable Carburetor: install with the bend on the regulator towards the right. Install the insert and turn it to the proper flow rate position depending on the mix.

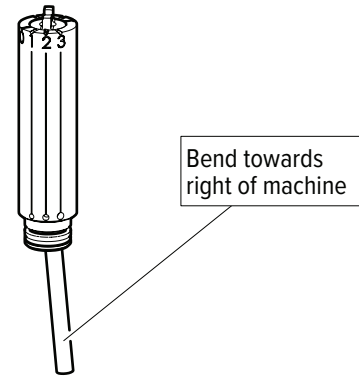

Figure 3-10 Adjustable Carburetor

The machine is now sanitized and ready for adding mix.

3.8 FREEZING DOWN & OPERATING

Sanitize immediately before use.

1. Fill the hopper with at least 2.5 gallons of mix.
2. Place a container under the spigot and open the spigot to allow the mix to flush out about 8 ounces (0.23 liters) of sanitizing solution and liquid mix.
3. Allow the freezing cylinder to fill.

NOTE

The freezing cylinder is filled when the mix level in the freezing cylinder reaches the top o-ring on the spigot.

4. Press the On/Off button to turn on the freezing cylinder. Then press the PUSH TO FREEZE button.
5. When the product is ready, the display reads "SERVE". Open the spigot to dispense product.

NOTE

If the product consistency needs to be adjusted, use the Technician passcode and go to the Basic Settings menu. Adjust the CutIn Consistency Offset higher to increase the consistency or lower to decrease the consistency. Make adjustments in increments of 2 for best results.

6. The machine dispenses product at a reasonable draw rate. If the machine is overdrawn, the result is a soft product or a product that will not dispense at all. If this occurs, allow the machine to run for approximately 30 seconds before dispensing more product. A dispense rate adjuster is located under the header panel, to the immediate right of the spigot handle. Turning the knob to the right decreases the dispense rate.
7. Do not operate the machine when the MIX LOW message is displayed. Refill the hopper immediately.

NOTE

After a preset number of freezing cycles in Serve mode, the control enters sleep mode and remains there until someone draws product or presses the PUSH TO FREEZE button. In the sleep mode, the machine keeps the product below 41°F (5°C). Sleep modes do not take the place of cleaning and sanitizing. Federal, State, and local regulatory agencies determine frequency of cleaning and sanitizing.

3.9 MIX INFORMATION

Mix can vary considerably from one manufacturer to another. Differences in the amount of butterfat content and quantity and quality of other ingredients have a direct bearing on the finished frozen product. A change in machine performance that cannot be explained by a technical problem may be related to the mix.

Proper product serving temperature varies from one manufacturer's mix to another. Most dairy mixes provide a satisfactory product in the 18°F to 21°F range. No Sugar Added (NSA) and water-based mixes typically freeze to proper consistency at higher temperatures.

When checking the temperature, stir the thermometer in the frozen product to get an accurate reading.

Old mix, or mix that has been stored at too high a temperature, can result in a finished product that is unsatisfactory. To retard bacteria growth in dairy based mixes, the best storage temperature range is between 33° to 38°F (0.5° to 3.3° C).

Section 4 - Maintenance & Adjustments

This section is intended to provide maintenance personnel with a general understanding of the machine adjustments. It is recommended that any adjustments be made by a qualified person.

WARNING

Hazardous voltage

The machine must be disconnected from electrical supply before servicing. Failure to disconnect power before servicing could result in death or serious injury.

4.1 FINE CONSISTENCY ADJUSTMENT

Product consistency can be adjusted on the Fine Consistency Adjustment screen. To get to the Fine Consistency Adjustment Screen, press the right arrow then the SEL button from the Current Status screen. Then move the cursor to the Fine Consistency Adjustment option and press the SEL button.

Fine Consistency Adjustment	
Cylinder	Right
Changing the fine consistency changes the firmness of the product.	
Consistency CutIn Limit	00
Consistency CutOut Limit	00
_ Fine Consistency	00.0

Figure 4-1 Fine Consistency Adjustment

Increasing the Fine Consistency number increases the product consistency (firmer product). The Consistency Limits show the Fine Consistency adjustment added to the Consistency number.

NOTE

Make adjustments in increments of 2 for best results.

4.2 PREVENTIVE MAINTENANCE

It is recommended that a preventative maintenance schedule be followed to keep the machine clean and operating properly. The following steps are suggested as a preventative maintenance guide.

A. DAILY CHECKS

Check for worn or broken parts and replace parts as necessary.

Check for any unusual noise or condition and repair immediately.

B. MONTHLY CHECKS

Have a qualified service technician check the condenser filter for dirt and clean if necessary.

C. QUARTERLY CHECKS

Have a qualified service technician check drive belts for wear and have them tightened if necessary.

WARNING

Service must be completed by a qualified electrician/refrigeration specialist.

Improper service may cause severe personal injury, or damage to the machine.

4.3 EXTENDED STORAGE

Refer to the following steps for storage of the machine over any long period of shutdown time:

1. Thoroughly clean all parts that come in contact with mix with warm detergent water. Rinse in clear water and dry all parts. Do not sanitize.

NOTE

Do not let cleaning solution stand in the freezing cylinder or hopper during the shutdown period.

2. Remove, disassemble, and clean the front door, and auger shaft. Leave disassembled during the shutdown period.
3. Place the auger flights and auger support bushing in a plastic bag with a moist paper towel. This prevents them from becoming brittle if exposed to dry air over an extended period (over 30 days).

4. For water-cooled machines that are left in unheated buildings, or buildings subject to freezing, the water must be shut off and disconnected.
 - a. Disconnect the water inlet fitting. The fitting is located at the rear of the machine.
 - b. Press the PUSH TO FREEZE button to run the compressor for 2 - 3 minutes which opens water valve (temporarily place the front door on the machine for the compressor to run).
 - c. While the machine is running, use compressed air to blow out all of the water through water inlet.
 - d. Drain the water supply line coming to the machine.
 - e. Disconnect the water outlet fitting.
5. Press the Main Power On/Off button to turn the machine off.
6. Disconnect the machine from the power source.

Section 5 - Troubleshooting

5.1 ERROR CODES

When the machine experiences a problem, one of the following error codes is displayed on the control panel. Each error code directs you to the system location of the malfunction.

ERROR CODE	MALFUNCTION
2	High Torque
3	Run Time
4	Clean
5	Freezing Cylinder Sensor
6	Hopper Sensor (single hopper machines)
7	Drive Motor
8	Cab Sensor
9	High Pressure Cutout
10	Auxiliary Sensor
11	Prime (cab units only)
12	Left Hopper Sensor
13	Right Hopper Sensor
21	Spigot Open Time

To return the machine to normal operation, any error causing condition must be corrected and the power to the affected freezing cylinder must be cycled. Turn the power to the freezing cylinder off then back on using the On/Off button of the affected freezing cylinder.

5.2 TROUBLESHOOTING ERROR CODES

Error Code 2 - High Torque

If the control panel displays a High Torque Error (E2), the controller has sensed that the drive motor is running at a high load for 10 or more seconds. This may be due to the product consistency adjustment being set too high. Press the On/Off button for the cylinder to turn it off, wait until the product in the freezing cylinder thaws and then turn the cylinder back on. Follow the instructions in Section 3 to reduce the product consistency by a few levels. If the error persists, contact Stoelting White Glove Service for further assistance.

Error Code 3 - Run Time

The Run Time Error (E3) occurs when the compressor runs continuously for an extended period. This error is generally caused by very low mix levels in the hopper or from product breakdown. Another common cause results from a restriction preventing mix from entering the freezing cylinder. Check the mix in the hopper. If the level mix is low, add mix. If there is a possibility that the mix has broken down, clean and sanitize the machine and replace the mix with fresh product.

Ice crystals in the hopper can clog the mix inlet system and prevent mix from entering the freezing cylinder. Thoroughly thaw mix per manufacturer's recommendations. To check for ice crystals, pour a small amount of product from the mix container through a clean and sanitized sieve or strainer. If ice crystals are in the mix, check temperature of the walk-in cooler where the mix is stored.

In air cooled machines, the Run Time Error may indicate that airflow within the machine has reduced or stopped. Check the sides of the machine for anything that would restrict airflow.

If the error persists after attempting to clear it, contact Stoelting White Glove Service for further assistance.

Error Code 4 - Clean

If the machine is left in the Clean Mode for more than 20 minutes, the control panel displays a Clean Error (E4). This condition does not reflect a problem with the machine itself. The Clean Error has been programmed into the controller as a safeguard to protect the machine from potential damage caused by the machine being accidentally left in Clean Mode. To clear the Clean Error, press the On/Off button to turn it off then back on.

Error Code 5 - Freezing Cylinder Sensor

The Freezing Cylinder Sensor Error (E5) indicates a failure of the sensor or that the sensor is out of range. If the control panel displays an E5, press the On/Off button to turn it off then back on. If the error persists, contact Stoelting White Glove Service for further assistance.

NOTE

When the machine encounters a Freezing Cylinder Sensor Error, the machine continues to run using preset timers. This mode allows the operator to continue serving product until the machine can be serviced.

Error Code 6 - Hopper Sensor (single hopper machines)

The Hopper Sensor Error (E6) does not occur on this machine.

Error Code 7 - Drive Motor

If the control panel displays a Drive Motor Error (E7), the control does not sense current coming from the drive motor. Press the On/Off button turn if off then back on. If the error persists, contact Stoelting White Glove Service for further assistance.

Error Code 8 - Cab Sensor

A Cab Sensor Error (E8) does not occur on the machine.

Error Code 9 - High Pressure Cutout

High Pressure Cutout Errors (E9) are usually caused by a dirty or inefficient condenser. If the control panel displays an E9 on an air cooled machine, check for proper air clearance around the machine. If there is an E9 on a water cooled machine check for proper flow from the water supply or kinks in the hoses.

If the error persists, contact Stoelting White Glove Service for further assistance.

Error Code 10 - Auxiliary Sensor

An Auxiliary Temperature Sensor Error (E10) occurs if the temperature sensor on the control board fails. Press the On/Off button to turn it off then back on. If the error persists, contact Stoelting White Glove Service for further assistance.

Error Code 11 - Prime Error

The Prime Error (E11) does not occur on the machine.

Error Code 12 - Left Hopper Sensor

The Left Hopper Sensor Error (E12) indicates a failure of the hopper sensor or that the sensor is out of range. If the control panel displays an E12, press the On/Off button for the cylinder to turn it off then back on. If the error persists, contact Stoelting White Glove Service for further assistance.

Error Code 13 - Right Hopper Sensor

The Right Hopper Sensor Error (E13) indicates a failure of the hopper sensor or that the sensor is out of range. If the control panel displays an E12, press the On/Off button for the cylinder to turn it off then back on. If the error persists, contact Stoelting White Glove Service for further assistance.

Error Code 21 - Spigot Open Time

The Spigot Open Time Error (E21) indicates a failure of the spigot switch. If the control senses the spigot is open continuously for 10 minutes, the machine goes into Sleep 3 mode. If the control panel displays an E21, press the On/Off button for the cylinder to turn if off then back on. If the error persists, contact Stoelting White Glove Service for further assistance.

5.3 TROUBLESHOOTING MACHINE

PROBLEM	POSSIBLE CAUSE	REMEDY
Machine does not run.	<ol style="list-style-type: none"> 1 Power to machine is off. 2 Freeze-up (auger will not turn). 3 Front door not in place. 	<ol style="list-style-type: none"> 1 Supply power to machine. 2 Turn machine off for 15 minutes, then restart. 3 Assemble front door in place.
Machine will not shut off.	<ol style="list-style-type: none"> 1 Refrigeration problem. 	<ol style="list-style-type: none"> 1 Check system. (Call Stoelting White Glove Service)
Product is too firm.	<ol style="list-style-type: none"> 1 CutIn Consistency setting too high 	<ol style="list-style-type: none"> 1 Adjust the CutIn Consistency Offset (See Section 3)
Product is too soft.	<ol style="list-style-type: none"> 1 No vent space for free flow of cooling air. 2 Air temperature entering condenser is above 100°F. 3 Condenser is dirty. 4 CutOut Consistency setting too low 5 Auger is assembled incorrectly. 6 Refrigeration problem. 	<ol style="list-style-type: none"> 1 A minimum of 3" of air space on the sides. 2 Change location or direct hot air away from machine. 3 Clean the condenser. (See Section 4) 4 Adjust the CutOut Consistency (Refer to the IntelliTec2® manual) 5 Remove mix, clean, reassemble, sanitize and freeze down. 6 Check system. (Call Stoelting White Glove Service)
Product does not dispense.	<ol style="list-style-type: none"> 1 No mix in hopper. 2 Mix inlet regulator is plugged 3 Drive motor overload tripped. 4 Drive belt failure. 5 Freeze-up (Auger will not turn). 	<ol style="list-style-type: none"> 1 Add mix to the hopper. 2 Clean the mix inlet regulator 3 Wait for automatic reset. (If condition continues, call Stoelting White Glove Service.) 4 Replace drive belt. 5 Turn off cylinder, wait for 15 minutes, then restart.
Drive belt slipping or squealing.	<ol style="list-style-type: none"> 1 Worn drive belt. 2 Freeze-up (Auger will not turn). 3 Not tensioned properly. 	<ol style="list-style-type: none"> 1 Replace drive belt. 2 Turn off cylinder, wait for 15 minutes, then restart. 3 Adjust belt tension
Rear auger seal leaks.	<ol style="list-style-type: none"> 1 Outside surface of rear auger seal is lubricated. 2 Rear seal missing or damaged. 3 Seal o-ring missing, damaged or installed incorrectly. 4 Worn or scratched auger shaft. 	<ol style="list-style-type: none"> 1 Clean lubricant from outside of rear seal and thoroughly clean rear of freezing cylinder. Lubricate inside of seal and reinstall. 2 Check or replace. 3 Check or replace. 4 Replace auger shaft.
Front door leaks.	<ol style="list-style-type: none"> 1 Front door knobs are loose. 2 Spigot parts are not lubricated. 3 Chipped or worn spigot o-rings. 4 O-rings or spigot installed wrong. 5 Inner spigot hole in front door nicked or scratched. 	<ol style="list-style-type: none"> 1 Tighten knobs. 2 Disassemble, clean, lubricate then reassemble. 3 Replace o-rings. 4 Remove spigot and check o-ring. 5 Replace front door.

Section 6 - Replacement Parts

6.1 DECALS & LUBRICATION

Part	Description	Quantity	
		E131-I2	F131-I2
C-1000-26C	Decal - Made In USA	1	1
208135	Brush - 4" x 8" x 16" (Barrel)	1	1
208380	Brush - 1/4" x 3" x 14"	1	1
208401	Brush - 1" x 3" x 10"	1	1
208467	Brush - 3/8" x 1" x 5"	1	1
232741	Cap - Rosette (6-Point Teardrop) (Translucent)	-	-
236059	Card - Cleaning Instructions	1	1
324065	Decal - Water Inlet	1	1
324105	Decal - Caution Electrical Shock	3	3
324106	Decal - Caution Electrical Wiring Materials	1	1
324107	Decal - Caution Hazardous Moving Parts	3	2
324141	Decal - Caution Rotating Blades	1	1
324208	Decal - Attention Refrigerant Leak Check	2	2
324509	Decal - Cleaning Instructions	1	1
324566	Decal - Wired According To	1	1
324584	Decal - Adequate Ventilation 3"	2	2
324594	Decal - Attention Heat Sensitive	4	4
324864	Decal - A&W Logo	1	1
324909	Decal - USB Port	1	1
324922	Decal - Assembly Check	1	1
324940	Decal - Thermistor ID	1	1
325023	Decal - Stoelting (Black) (Large) (Header Panel) (Pre Flavor Burst)	1	1
325032	Decal - White Glove Service	1	1
325075	Decal - Stoelting Enhanced By Flavor Burst (Black) (Header Panel)	1	1
396241	Gasket - Freezer Base	1	1
508053	Lubricant - Total Blend (50 Packets)	1	1
513682	Manual - Service	-	-
1159501	O-Ring & Bushing Kit	-	-
2177072	Extension - Spigot - 1.5" (0.88" Opening)	-	-
2177073	Extension - Spigot - 2.5" (0.88" Opening)	-	-
2177074	Extension - Spigot - 3.2" (0.88" Opening)	-	-
2177917	Brush Kit	-	-

6.2 AUGER & FRONT DOOR

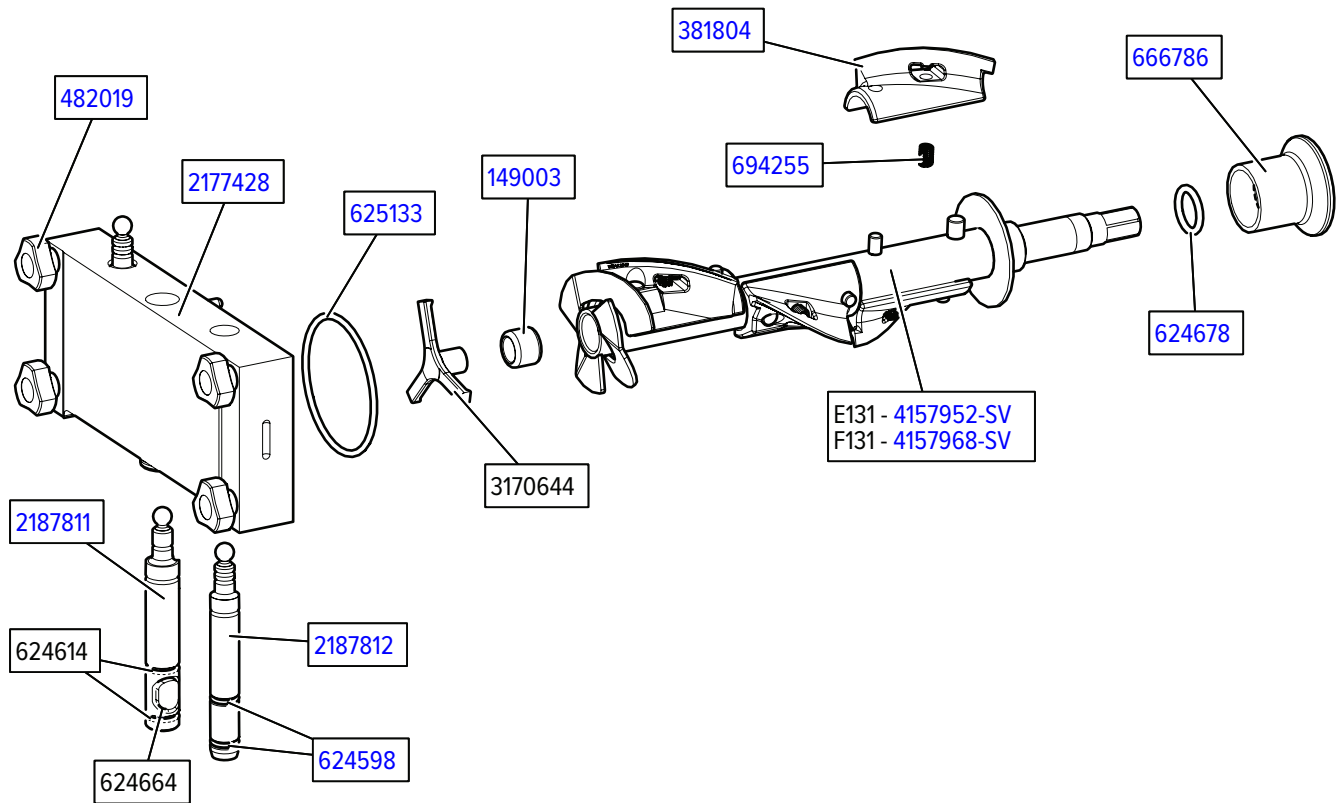

Part	Description	Quantity	
		E131-I2	F131-I2
149003	Bushing - Front Auger Support	2	2
381804	Auger Flight	3	4
482019	Knob - Front Door (Black)	4	4
624598-5	O-Ring - Outside Spigot - Black (5 Pack)	4	4
624614-5	O-Ring - Top & Bottom Center Spigot - Black (5 Pack)	2	2
624664-5	O-Ring - Middle Center Spigot - Black (5 Pack)	1	1
624678-5	O-Ring - Rear Seal - Black (5 Pack)	2	2
625133	O-Ring - Front Door - Red	2	2
666786	Seal - Rear Auger - Black	2	2
694255	Spring - Auger Flight	3	4
2177428	Door w/Pins	1	1
2187811	Spigot Body - Center	1	1
2187812	Spigot Body - Outer	2	2
4157952-SV	Auger Shaft	2	
4157968-SV	Auger Shaft	-	2

6.3 TRAYS & HOPPER COVER



Part	Description	Quantity	
		E131-I2	F131-I2
417006	Insert - Drip Tray (Vinyl Coated Metal) (YG2 Only)	-	-
624677-5	O-Ring - Carburetor Assembly & Spigot Extension - Black (5 Pack)	4	4
744260-SV	Tray - Drip	1	1
744262	Tray - Drain (Black Plastic) (16 1/4" Long)	2	2
744271	Insert - Drip Tray (Black Plastic)	1	1
744273	Tray - Drip (Black Plastic) (YG2 Only)	-	-
2149243-01	Carburetor Assembly - 3/16" Hole - Standard Length (2A)	2	2
2203352	Carburetor Tube Only (2204806 Adjustable Carburetor Assembly)	-	-
2203353	Carburetor Tube Insert Only (2204806 Adjustable Carburetor Assembly)	-	-
2204806	Carburetor Assembly - Adjustable	-	-
2206054	Cover - Hopper/Parts Tray	2	2
2206858	Insert - Drip Tray (Louvered Stainless) (For #744273 Drip Tray)	-	-