



**Model E131-OT2 / F131-OT2**  
**SERVICE MANUAL**

Manual No. [513648](#)

Rev.0



This manual provides basic information about the machine. Instructions and suggestions are given covering its operation and care.

The illustrations and specifications are not binding in detail. We reserve the right to make changes to the machine without notice, and without incurring any obligation to modify or provide new parts for machines built prior to date of change.

**DO NOT ATTEMPT** to operate the machine until instructions and safety precautions in this manual are read completely and are thoroughly understood. If problems develop or questions arise in connection with installation, operation, or servicing of the machine, contact Stoelting.



[stoeltingfoodservice.com](http://stoeltingfoodservice.com)

Stoelting Foodservice Equipment  
502 Highway 67  
Kiel, WI 53042-1600  
U.S.A.

Main Tel: 800.558.5807  
Fax: 920.894.7029

Customer Service: 888.429.5920  
Fax: 800.545.0662  
Email: [foodservice@stoelting.com](mailto:foodservice@stoelting.com)

© 2014 PW Stoelting, LLC

---

## ***A Few Words About Safety***

### **Safety Information**

**Read and understand the entire manual before operating or maintaining Stoelting equipment.**

This manual provides the operator with information for the safe operation and maintenance of Stoelting equipment. As with any machine, there are hazards associated with their operation. For this reason safety is emphasized throughout the manual. To highlight specific safety information, the following safety definitions are provided to assist the reader.

The purpose of safety symbols is to attract your attention to possible dangers. The safety symbols, and their explanations, deserve your careful attention and understanding. The safety warnings do not by themselves eliminate any danger. The instructions or warnings they give are not substitutes for proper accident prevention measures.

If you need to replace a part, use genuine Stoelting parts with the correct part number or an equivalent part. We strongly recommend that you do not use replacement parts of inferior quality.



### **Safety Alert Symbol:**

**This symbol** Indicates danger, warning or caution. Attention is required in order to avoid serious personal injury. The message that follows the symbol contains important information about safety.

### **Signal Word:**

Signal words are distinctive words used throughout this manual that alert the reader to the existence and relative degree of a hazard.



The signal word "WARNING" indicates a potentially hazardous situation, which, if not avoided, may result in death or serious injury and equipment/property damage.



The signal word "CAUTION" indicates a potentially hazardous situation, which, if not avoided, may result in minor or moderate injury and equipment/property damage.

### **CAUTION**

The signal word "CAUTION" not preceded by the safety alert symbol indicates a potentially hazardous situation, which, if not avoided, may result in equipment/property damage.

### **NOTE (or NOTICE)**

The signal word "NOTICE" indicates information or procedures that relate directly or indirectly to the safety of personnel or equipment/property.

# TABLE OF CONTENTS

Section	Description	Page
<b>1</b>	<b>Description and Specifications</b>	
1.1	Description .....	1
1.2	Specifications .....	1
1.3	Modes of Normal Operation .....	4
1.4	Mix Level Indicators .....	6
1.5	Hopper Refrigeration .....	6
1.7	Motor Profile Cutout Compensation .....	6
<b>2</b>	<b>Installation Instructions</b>	
2.1	Safety Precautions .....	9
2.2	Shipment and Transit .....	9
2.3	Machine Installation .....	9
<b>3</b>	<b>Initial Set-Up and Operation</b>	
3.1	Operator's Safety Precautions .....	11
3.2	Operating Controls and Indicators .....	11
3.3	Important Information Regarding Cleaning and Sanitizing .....	13
3.4	Disassembly of Machine Parts .....	14
3.5	Cleaning Disassembled Parts .....	15
3.6	Sanitizing Machine Parts .....	15
3.7	Cleaning the Machine .....	15
3.8	Assembling the Machine .....	16
3.9	Sanitizing .....	16
3.10	Initial Freeze Down and Operation .....	17
3.11	Normal Freeze Down and Operation .....	18
3.12	Mix Information .....	18
<b>4</b>	<b>Maintenance and Adjustments</b>	
4.1	Machine Adjustment .....	19
4.2	Product Consistency Adjustment .....	19
4.3	Locking the Control Panel .....	19
4.4	Obtaining Readings and Modifying Settings .....	19
4.5	Readings .....	21
4.6	Adjustments .....	22
4.7	Other Settings .....	22
4.8	Drive Belt Tension Adjustment .....	23
4.9	Condenser Cleaning .....	23
4.10	Preventative Maintenance .....	24
4.11	Extended Storage .....	24

<b>Section</b>	<b>Description</b>	<b>Page</b>
<b>5</b>	<b>Refrigeration System</b>	
5.1	Refrigeration System .....	25
5.2	Refrigerant Recovery and Evacuation .....	25
5.3	Refrigerant Charging .....	26
5.4	Compressor .....	27
5.5	Condenser .....	28
5.6	Valves .....	28
A.	Thermostatic Expansion Valve (TXV) .....	28
B.	Check Valve .....	29
C.	High Pressure Cutout .....	29
D.	Hot Gas Bypass .....	30
E.	Evaporator Pressure Regulator (EPR) .....	31
F.	Water Valve (Water Cooled Models Only) .....	31
5.7	Solenoid .....	32
5.8	Filter Drier .....	34
5.9	Capillary Tube .....	34
<b>6</b>	<b>Electrical and Mechanical Control Systems</b>	
6.1	IntelliTec Controller .....	35
6.2	Contactors .....	35
6.3	Drive Motor .....	36
6.4	Capacitors .....	37
6.5	Gearbox .....	38
6.6	Condenser Fan Motor (Air Cooled Models Only) .....	38
6.7	Spigot Switch .....	39
6.8	Temperature Control Sensor .....	40
<b>7</b>	<b>Troubleshooting</b>	
7.1	Error Codes .....	41
7.2	Troubleshooting .....	41
7.3	Servicing Tip .....	43
7.4	Troubleshooting - Machine .....	44
<b>8</b>	<b>Replacement Parts</b>	
8.1	Decals & Lubrication .....	45
8.2	Auger Shaft and Faceplate Parts .....	46
8.3	Machine Front .....	48
8.4	Panels .....	48
8.5	Left Side .....	49
8.6	Right Side .....	50
8.7	Front .....	50
8.8	Rear .....	52
8.9	Refrigeration Diagram & Wiring Diagram .....	54

# SECTION 1 INTRODUCTION

## 1.1 DESCRIPTION

The Stoelting E131OT2 and F131OT2 counter machines are gravity fed. The machines are equipped with fully automatic controls to provide a uniform product. They are designed to operate with almost any type of commercial soft serve or non-dairy mixes available, including: ice milk, ice cream, yogurt, and frozen dietary desserts.

This manual is designed to assist qualified service personnel and operators in the installation, operation and maintenance of the Stoelting E131OT2 and F131OT2 gravity machine.



Figure 1-1 E131OT2 / F131OT2 Machine

## 1.2 SPECIFICATIONS

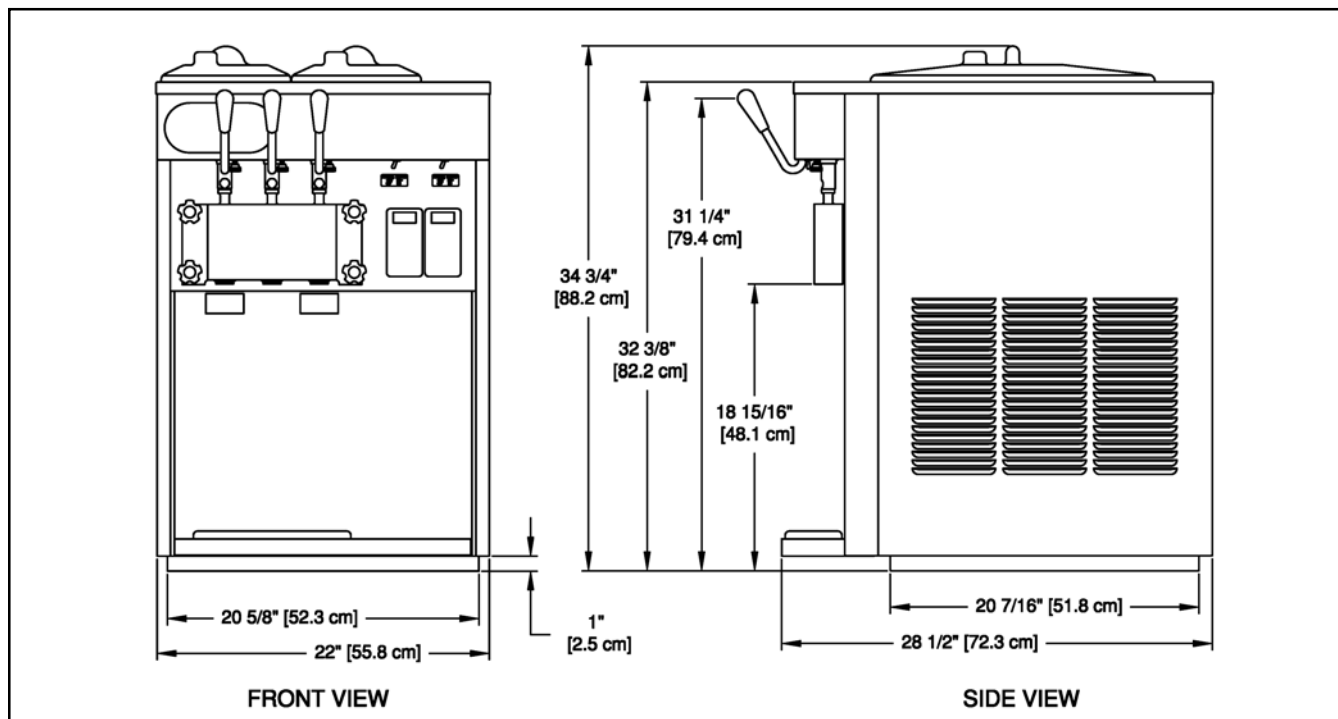

Figure 1-2 Specification

## 1.2 E131I SPECIFICATIONS

Model E131OT2			
<b>Dimensions</b>	<b>Machine</b>	<b>with crate</b>	
	width	22" (55,9 cm)	28" (71,1 cm)
	height	34-3/4" (88,3 cm)	40-1/4" (102,2 cm)
	depth	28-1/2" (72,4 cm)	35-1/4" (89,5 cm)
<b>Weight</b>	370 lbs (167,8 kg)	450 lbs (204,1 kg)	
<b>Electrical</b>	<b>1 Phase, 208-230 VAC, 60Hz</b>		
running amps	approximately 12A		
connection type	NEMA6-20P power cord provided		
International Option	1 Phase, 220-240 VAC, 50Hz		
<b>Compressor</b>	8,600 Btu/hr (R-404A)		
<b>Drive Motor</b>	Two - 3/4 hp		
<b>Air Flow</b>	Air cooled units require 3" (7,6 cm) air space on both sides		
<b>Plumbing Fittings</b>	Water cooled units require 3/8" N.P.T. water and drain fittings.		
<b>Hopper Volume</b>	Two - 3 gallon (11,35 liters)		
<b>Freezing Cylinder Volume</b>	Two - 0.5 gallon (2 quart), 1,89 liters		
<b>Production Capacity</b>	5 GPH (18,93 liters) each Freezing Cylinder 8.5 GPH (32,18 liters) both Freezing Cylinders		

E131OT2	
<b>Refrigerant</b>	R-404A
<b>Charge</b>	(W/C) 26 oz (A/C) 32 oz
<b>Suction Pressure (at 72°F)</b>	One Cylinder 22-24 psig Hopper Only 14 psig
<b>Discharge Pressure</b>	225-235 psig
<b>Hot Gas Bypass Pressure</b>	14 psig (only hopper running)
<b>EPR Valve</b>	59-61 psig

Menu	Display	Value
<b>Basic</b>	CutOut	* amps
	Cut In T	22 °F
	Cycles	20 count
	Stir On	15 seconds
	Stir Off	300 seconds
<b>Advanced</b>	On Time	25 seconds
	Off Time	450 seconds
	Stb Time	120 minutes
	SI1DrvOn	120 seconds
	SI1DrOff	180 seconds
	SI2CutIn	35 °F
	SI2CtOut	30 °F
	DftOffTm	600 seconds
<b>Storage (Left control only)</b>	Refriger	** 2 Hopper
	HprCutIn	37.5 °F
	HprCtOut	32 °F
	HprOffst	8 °F
	Hpr Off	13 minutes
	Hpr On	130 seconds

\* CutOut amps must be set on site.

\*\* The Refriger setting on the right control board must be set to None.

## 1.2 F131I SPECIFICATIONS

Model F131OT2			
<b>Dimensions</b>	<b>Machine</b>	<b>with crate</b>	
	width	22" (55,9 cm)	28" (71,1 cm)
	height	34-3/4" (88,3 cm)	40-1/4" (102,2 cm)
	depth	28-1/2" (72,4 cm)	35-1/4" (89,5 cm)
<b>Weight</b>	385 lbs (174,6 kg)	470 lbs (213,1 kg)	
<b>Electrical</b>	<b>1 Phase, 208-230 VAC, 60Hz</b>		
running amps	approximately 12A		
connection type	NEMA6-20P power cord provided		
International Option	1 Phase, 220-240 VAC, 50Hz		
<b>Compressor</b>	12,000 Btu/hr (R-404A)		
<b>Drive Motor</b>	Two - 3/4 hp		
<b>Air Flow</b>	Air cooled units require 3" (7,6 cm) air space on both sides		
<b>Plumbing Fittings</b>	Water cooled units require 3/8" N.P.T. water and drain fittings.		
<b>Hopper Volume</b>	Two - 3 gallon (11,35 liters)		
<b>Freezing Cylinder Volume</b>	Two - 0.85 gallon (3.4 quart), 3,22 liters		
<b>Production Capacity</b>	8 GPH (30,29 liters) each Freezing Cylinder 11.5 GPH (43,53 liters) both Freezing Cylinders		

F131OT2	
<b>Refrigerant</b>	R-404A
<b>Charge</b>	(W/C) 32 oz (A/C) 42 oz
<b>Suction Pressure (at 72°F)</b>	One Cylinder 22-24 psig Hopper Only 14 psig
<b>Discharge Pressure</b>	225-235 psig
<b>Hot Gas Bypass Pressure</b>	14 psig (only hopper running)
<b>EPR Valve</b>	59-61 psig

Menu	Display	Value
<b>Basic</b>	CutOut	* amps
	Cut In T	22 °F
	Cycles	20 count
	Stir On	15 seconds
	Stir Off	300 seconds
<b>Advanced</b>	On Time	15 seconds
	Off Time	450 seconds
	Stb Time	120 minutes
	SI1DrvOn	120 seconds
	SI1DrOff	180 seconds
	SI2CutIn	33 °F
	SI2CtOut	30.5 °F
	DftOffTm	600 seconds
<b>Storage (Left control only)</b>	Refriger	** 2 Hopper
	HprCutIn	37.5 °F
	HprCtOut	32 °F
	HprOffst	8 °F
	Hpr Off	13 minutes
	Hpr On	130 seconds

\* CutOut amps must be set on site.

\*\* The Refriger setting on the right control board must be set to None.

### 1.3 MODES OF NORMAL OPERATION

Following are details of the operational modes of the IntelliTec control.

#### NOTE:

*The preset amounts, times, and temperatures listed below are references to actual settings on the IntelliTec control. Refer to Table 1-1 on page 7 for details on each setting.*

#### A. INITIAL STATUS

When the Main Freezer Power and Freezing Cylinder switches are placed in the ON position, the machine will start in the "Sleep 1 Mode". The display will read "Sleep 1 Mode". The control will eventually move into the "Sleep 2" mode if the PUSH TO FREEZE button is not pressed. When the PUSH TO FREEZE button is pressed the control will move to the "Serve Mode".

#### B. SERVE MODE

When the PUSH TO FREEZE button is pressed or a spigot handle is pulled, the "Serve Mode" begins. The drive motor starts, and after a 3 second delay, the compressor starts. The display reads "FREEZING" on the top line and a bar on the bottom line increases with product consistency. A toroid on the IntelliTec control senses increasing drive motor amperage as the product comes to consistency in the freezing cylinder. When the control senses the product is at 75% of consistency, the display will read "SERVE", the amber LED will go out, and the green LED will flash. At this time, product can be served from the machine. The drive motor and compressor will continue to run until the toroid reads a preset value (CutOut amps). When the toroid reads the CutOut amps on the drive motor, the compressor turns off and the green LED will remain lit. After a 3 second delay, the drive motor turns off. The product in the freezing cylinder is now at serving temperature and consistency.

After product is at consistency, the IntelliTec control continuously monitors refrigerant temperature through a thermistor mounted on the side of the freezing cylinder. When the temperature increases to a preset amount (Cut In T), a 3-second drive motor pre-stir analyzes product consistency. The pre-stir check is also performed each time the spigot handle is opened. This check prevents over-freezing of product, especially during frequent, small volume draws. If the product requires a freezing cycle, the control will start the cycle.

During the "Serve Mode", a stir cycle starts. This cycle is independent of the freezing cycle and is based on preset times (Stir On and Stir Off). The stir cycle prevents product separation. If a freezing cycle is initiated, the timer is reset.

In addition to the "Serve Mode" freezing cycle, there is a freezing cycle based on a preset time (DftOffTime). If this time is attained without a freezing cycle, the control will automatically start a freezing cycle.

The machine will remain in "Serve Mode" until the cycle count setting is attained. The cycle count is the number of active freezing cycles and is based on a preset value

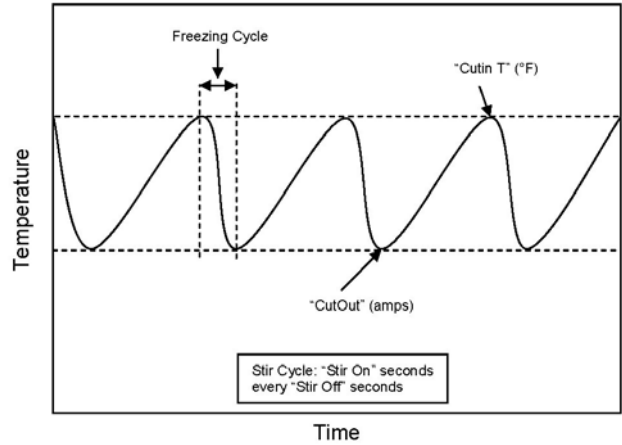

Figure 1-3 Serve Mode

(Cycles). Once the cycle count has been reached without user interruption, the control will move into the "Standby Mode".

If the PUSH TO FREEZE button is pressed or a spigot handle is pulled, the cycle count is reset and the control will move to the beginning of the "Serve Mode". Refer to Figure 1-3 for a graphical representation of the "Serve Mode".

#### C. STANDBY MODE

If no product has been drawn from the spigot and the preset number of active freezing cycles is met, the control moves into the "Standby Mode". In "Standby Mode", the freezing cycle is based on preset timers (On Time and Off Time), and prevents ice crystals from building up in the product. Because the product remains partially frozen, it can quickly return to servable consistency when the PUSH TO FREEZE button is pressed.

During "Standby Mode", the stir cycle runs. This cycle is based on preset, timed intervals (Stir On and Stir Off) and prevents product separation.

The "Standby Mode" maintains product quality during slow times, while minimizing reactivation time. This mode lasts for a preset time (Stb Time). Once this time has been reached without user interruption, the control moves into

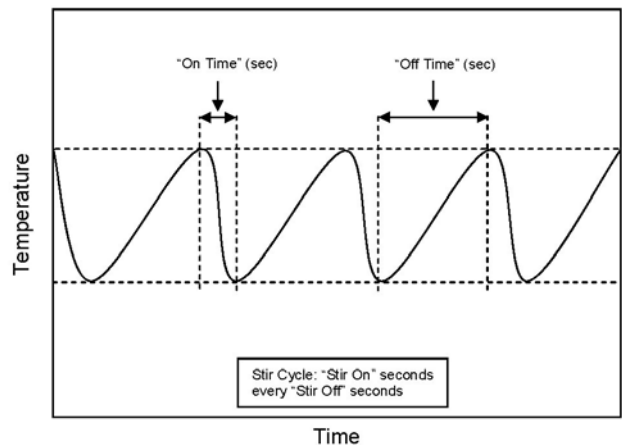

Figure 1-4 Standby Mode

the "Sleep 1 Mode". Refer to Figure 1-4 for a graphical representation of the "Standby Mode".

If a spigot is opened or the PUSH TO FREEZE button is pressed, the control will move to "Serve Mode". Product in the front of the freezing cylinders may or may not be at consistency. The state of the product is dependant on a number of variables but will come to consistency quickly.

#### D. SLEEP 1 MODE

After the "Standby Mode" time has expired without user interruption, the control will move into the "Sleep 1 Mode". During the "Sleep 1 Mode", the stir cycle is handled by preset timers (SI1DrvOn and SI1DrOff), and allows product to melt to a liquid state by using agitation cycles without any flow of refrigerant. Although the product temperature never increases above 40°F, the product thaws rapidly which minimizes product breakdown. The control will stay in the "Sleep 1 Mode" until sensing a preset temperature (SI2CutIn). When this temperature has been reached without user interruption, the control will move to the "Sleep 2 Mode". Refer to Figure 1-5 for a graphical representation of the "Sleep 1 Mode".

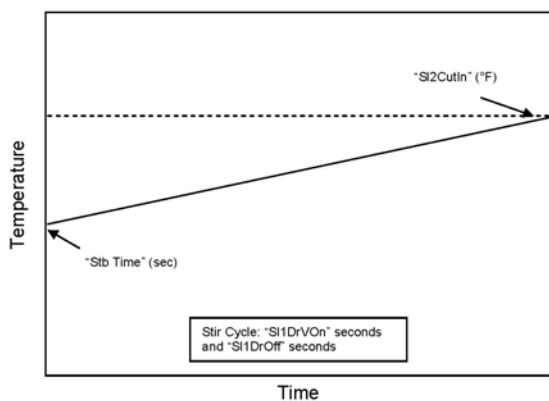

Figure 1-5 Sleep 1 Mode

If a spigot is opened or the PUSH TO FREEZE button is pressed, the control will move to "Serve Mode". If the spigot is opened in "Sleep 1 Mode", the product will not be at consistency. The operator must wait until the first "Serve Mode" freezing cycle has completed to serve product.

#### E. SLEEP 2 MODE

The "Sleep 2 Mode" maintains the freezing cylinder temperature between two preset values (SI2CutIn and SI2CtOut). During the "Sleep 2 Mode", the stir cycle runs. This cycle is based on preset, timed intervals (Stir On and Stir Off) and prevents product separation. The "Sleep 2 Mode" is often referred to by customers as the "night mode" and the machine will stay in this mode until a spigot is opened or the PUSH TO FREEZE button is pressed. When this occurs, the control will move to "Serve Mode". If the spigot is opened at this time, the product will be liquid. The operator must wait until the first "Serve Mode" freezing cycle has completed to serve product. Refer to Figure 1-6 for a graphical representation of the "Sleep 2 Mode".

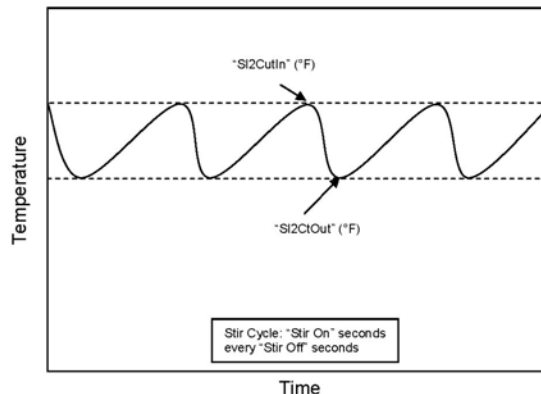

Figure 1-6 Sleep 2 Mode

#### F. INTELLITEC RESTART (VERSION 3.5 OR HIGHER)

If a hard error occurs (refer the hard error list below), the IntelliTec control will wait 5 minutes then attempt to clear the error by restarting itself. The control will count each restart attempt. The restart count will reset if the PUSH TO FREEZE button is pressed, the spigot is pulled, or the Freezing Cylinder OFF/ON switch is placed in the OFF position.

The following are considered hard errors:

ERROR CODE	MALFUNCTION
2	High Torque
3	Run Time
4	Clean
7	Drive Motor
9	High Pressure Cutout

When a restart occurs, the second line of the display will read "Restart" and the backlight will blink. This will occur regardless of the system mode.

#### G. SLEEP 3 MODE (VERSION 3.5 OR HIGHER)

If a high torque, run time, or drive motor error condition occurs on the third restart attempt, the control will move to the "Sleep 3 Mode".

In "Sleep 3 Mode" freezing cylinder refrigeration will run for 4 seconds every 10 minutes. This ensures the product temperature never increases above 40°F. The stir cycle and the auger do not run during "Sleep 3 Mode".

The control will exit "Sleep 3 Mode" if the PUSH TO FREEZE button is pressed, the spigot is pulled, or the Freezing Cylinder OFF/ON switch is placed in the OFF position.

#### H. CLEAN MODE

When the CLEAN button is pressed on the left side, all hopper refrigeration stops. When the CLEAN button is pressed on the right side, only the right barrel freezing cycle stops. In either case, the drive motor of that barrel starts and will run for 20 minutes and a 5 minute countdown timer is displayed. After the time has elapsed, an optional audible alarm will sound if this accessory has been installed. The

audible alarm is a reminder for the operator to end the "Clean Mode" when cleaning is completed.

If the machine is kept in "Clean Mode" for more than 20 minutes, the auger drive motor stops, the hopper refrigeration starts, and an error code (E4) is displayed on the display panel. The error code prevents damage to the machine that could occur during an extended clean mode (Refer to Section 8 - Troubleshooting for details). To clear this error, place the Freezing Cylinder Off-On switch in the Off position and back in the On position. If the machine is still being cleaned, pushing the CLEAN button will reset the timer and restart the "Clean Mode".

## 1.4 MIX LEVEL INDICATORS

The hoppers are equipped with a sensor that monitors mix level. When the mix level drops below the sensor probe, the lower line of the display will read "Low Mix" and the display will flash. To clear the "Low Mix" error, add mix to the hopper.

## 1.5 HOPPER REFRIGERATION

The IntelliTec control is programmed to handle refrigeration of the hopper independently from the freezing cylinder. The left control maintains hopper temperature between two preset values (HprCutIn and HprCutOut).

### NOTE

*The Refriger setting should be 2 Hopper for the Left control and None for the right control.*

The hopper refrigeration cycle starts when the temperature of either hopper reaches the HprCutIn value and stops when both hoppers reach the HprCutOut value.

In addition to this refrigeration cycle, hopper refrigeration may start when the freezing cycle starts. This reduces compressor cycles which preserves compressor life. Hopper refrigeration will start if the hopper temperature is above a preset value (HprOffst + HprCtOut). This value is always between HprCutIn and HprCtOut. Refrigeration of the hopper will continue until the HprCtOut is reached or until the freezing cycle is completed in the freezing cylinder.

The refrigeration cycle will run for a maximum of 4 minutes. After 4 minutes, the refrigeration cycle will stop for a minimum of 3 minutes. At the expiration of 3 minutes, the control will check product temperature. If product temperature is at or above HprCutIn, another refrigeration cycle will start.

### NOTE

*If the temperature in the cabinet stays above 50°F for more than two hours, the machine will go into Sleep Mode and a clean message will be shown on the display.*

## 1.6 OPERATION DURING SENSOR FAILURE

The IntelliTec control is designed to allow the machine to continue to function if a temperature sensor failure occurs. If a sensor fails, the display will show the error and the

control will run the machine on timers for the freezing cycle or hopper refrigeration. This allows the operator to continue to serve product from the machine until proper servicing can be completed.

## A. SERVE AND STANDBY MODE

In the event of a temperature sensor failure on a freezing cylinder, the IntelliTec control will function in two modes, "Serve Mode" and "Standby Mode". When the product is at consistency in "Serve Mode", the IntelliTec control uses a timer instead of the sensor and will not start another freezing cycle until a preset value (DftOffTme) is met.

The control will monitor product after it is at consistency, activating the stir cycle and counting the number of cycles. When the cycle count is reached, the control will move to "Standby Mode".

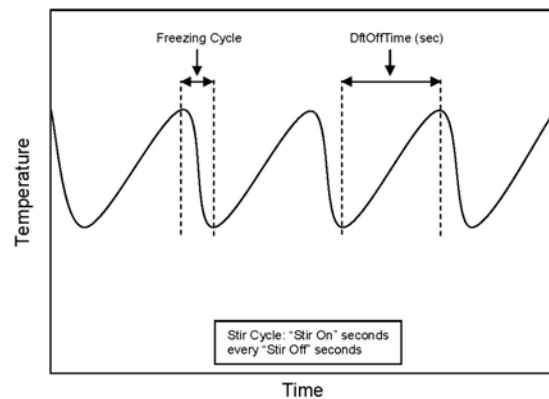

**Figure 1-7 Serve Mode (Sensor Failure)**

The "Standby Mode" is the same as in normal operation with the exception of when the preset time (Stb Time) is met, the control moves back into the "Serve Mode". Refer to Figure 1-7 for details.

In the event a hopper temperature sensor fails, the control will use the temperature of the other hopper to control the refrigeration cycle.

If both temperature sensors fail, the refrigeration cycle is managed by preset times (Hpr On and Hpr Off). This refrigeration cycle is independent of the freezing cycle.

## 1.7 MOTOR PROFILE CUTOUT COMPENSATION

The IntelliTec control is programmed to automatically function at a range of supply voltages. This feature provides the advantage of having product maintained at a specific temperature and consistency irrespective of the supply voltage. A motor profile curve is programmed on the IntelliTec control and provides a relationship between the supply voltage and drive motor cutout amperage. Depending on the supply voltage, the control varies cutout amperage according to the motor profile. This feature is automatic and does not need any configuring.

# IntelliTec Control Setting Specifications

Basic Menu	DISPLAY	E131 & F131		MODE	DEFINITION
	CutOut	*		Serve	Amp draw setting for cut out
	Cut In T	22°F		Serve	Temperature setting for cut in
	Cycles	20		Serve	Freezing cycles before going into Standby Mode
	Stir On	15 sec		Serve	Stir-only on time
	Stir Off	300 sec		Serve	Stir-only off time

Advanced Menu	DISPLAY	E131	F131	MODE	DEFINITION
	On Time	25 sec	15 sec	Standby	Freezing cycle "on" time (runs on timers only)
	Off Time	450 sec	450 sec	Standby	Freezing cycle "off" time
	Stb Time	120 min	120 min	Standby	Total time in mode
	SI1DrvOn	120 sec	120 sec	Sleep 1	Drive motor "on" timer
	SI1DrOff	180 sec	180 sec	Sleep 1	Drive motor "off" timer
	SI2CutIn	35°F	33°F	Sleep 2	Cut in temperature
	SI2CtOut	30°F	30.5°F	Sleep 2	Cut out temperature
	DftOffTm	600 sec	600 sec	No Sensor	Default "off" time. Used in case of sensor failure

Storage Menu	DISPLAY	E131 & F131		MODE	DEFINITION
	Refriger	** 2 Hopper		All	Set to None, 1 Hopper, 2 Hopper, or Cabinet
	HprCutIn	37.5°F		All	Refrigerated cab cut in temperature
	HprCtOut	32°F		All	Refrigerated cab cut out temperature
	Hpr Off	13 sec		No Sensor	Default "off" time. Used in case of sensor failure
	Hpr On	130 sec		No Sensor	Default "on" time. Used in case of sensor failure

\* The CutOut value needs to be adjusted to product requirements. Refer to the 2202077 - Specification Sheet for E131/F131 OT2 IntelliTec Control located in the plastic pouch behind the left side panel.

\*\* The Refriger setting on the right control board must be set to None.

**Table 1-1 IntelliTec Control Setting Specifications**



## SECTION 2 INSTALLATION INSTRUCTIONS

### 2.1 SAFETY PRECAUTIONS

Do not attempt to operate the machine until the safety precautions and operating instructions in this manual are read completely and are thoroughly understood.

Take notice of all warning labels on the machine. The labels have been put there to help maintain a safe working environment. The labels have been designed to withstand washing and cleaning. All labels must remain legible for the life of the machine. Labels should be checked periodically to be sure they can be recognized as warning labels.

If danger, warning or caution labels are needed, indicate the part number, type of label, location of label, and quantity required along with your address and mail to:

**STOELTING**  
**ATTENTION: Customer Service**  
**502 Hwy. 67**  
**Kiel, Wisconsin 53042**

### 2.2 SHIPMENT AND TRANSIT

The machine has been assembled, operated and inspected at the factory. Upon arrival at the final destination, the entire machine must be checked for any damage which may have occurred during transit.

With the method of packaging used, the machine should arrive in excellent condition. **THE CARRIER IS RESPONSIBLE FOR ALL DAMAGE IN TRANSIT, WHETHER VISIBLE OR CONCEALED.** Do not pay the freight bill until the machine has been checked for damage. Have the carrier note any visible damage on the freight bill. If concealed damage and/or shortage is found later, advise the carrier within 10 days and request inspection. The customer must place claim for damages and/or shortages in shipment with the carrier. Stoelting, Inc. cannot make any claims against the carrier.

### 2.3 MACHINE INSTALLATION

#### **WARNING**

**Installation must be completed by a qualified electrician/refrigeration specialist.**

Incorrect installation may cause personal injury, severe damage to the machine and will void factory warranty.

Installation of the machine involves moving the machine close to its permanent location, removing all crating, setting in place, assembling parts, and cleaning.

- A. Uncrate the machine.
- B. Accurate leveling is necessary for correct drainage of machine barrel and to insure correct overrun.



**Figure 2-1 Space and Ventilation Requirements**

Place a bubble level on top of the machine at each corner to check for level condition. If adjustment is necessary, level the machine by turning the bottom part of each leg in or out.

- C. The machine has a base gasket that must be installed. Separate the gasket and install it with the seam to the back. Make sure the angled side of the gasket is facing up.
- C. Correct ventilation is required. The right side of the machine is the air intake and left side is the discharge. Both sides must have 3" clearance.

#### **CAUTION**

Failure to provide adequate ventilation will void warranty.

- D. Place the Main Freezer Power Off/On switch in the OFF position.
- E. Connect the power cord to the proper power supply. The plug connected to the machine is a NEMA 6-20P. Check the nameplate on your machine for proper supply. The unit must be connected to a properly grounded receptacle. The electrical cord furnished as part of the machine has a three prong grounding type plug. The use of an extension cord is not recommended, if necessary use one with a size 12 gauge or heavier with ground wire. Do not use an adapter to circumvent the grounding requirement.

#### **WARNING**

Do not alter or deform electrical plug in any way. Altering the plug to fit into an outlet of different configuration may cause fire, risk of electrical shock, product damage and will void warranty.



## SECTION 3 INITIAL SET-UP AND OPERATION

### 3.1 OPERATOR'S SAFETY PRECAUTIONS

SAFE OPERATION IS NO ACCIDENT; observe these rules:

- A. Know the machine. Read and understand the Operating Instructions.
- B. Notice all warning labels on the machine.
- C. Wear proper clothing. Avoid loose fitting garments, and remove watches, rings or jewelry that could cause a serious accident.
- D. Maintain a clean work area. Avoid accidents by cleaning up the area and keeping it clean.
- E. Stay alert at all times. Know which switch, push button or control you are about to use and what effect it is going to have.
- F. Disconnect power for maintenance. Never attempt to repair or perform maintenance on the machine until the main electrical power has been disconnected.
- G. Do not operate under unsafe operating conditions. Never operate the machine if unusual or excessive noise or vibration occurs.

### 3.2 OPERATING CONTROLS AND INDICATORS

Before operating the machine, it is required that the operator know the function of each operating control. Refer to Figure 3-1 for the location of the operating controls on the machine. For the information regarding error codes displayed on the control panel, refer to the troubleshooting section of this manual.

#### **WARNING**

High voltage will shock, burn or cause death. The OFF-ON switch must be placed in the OFF position prior to disassembling for cleaning or servicing. Do not operate machine with panels removed.

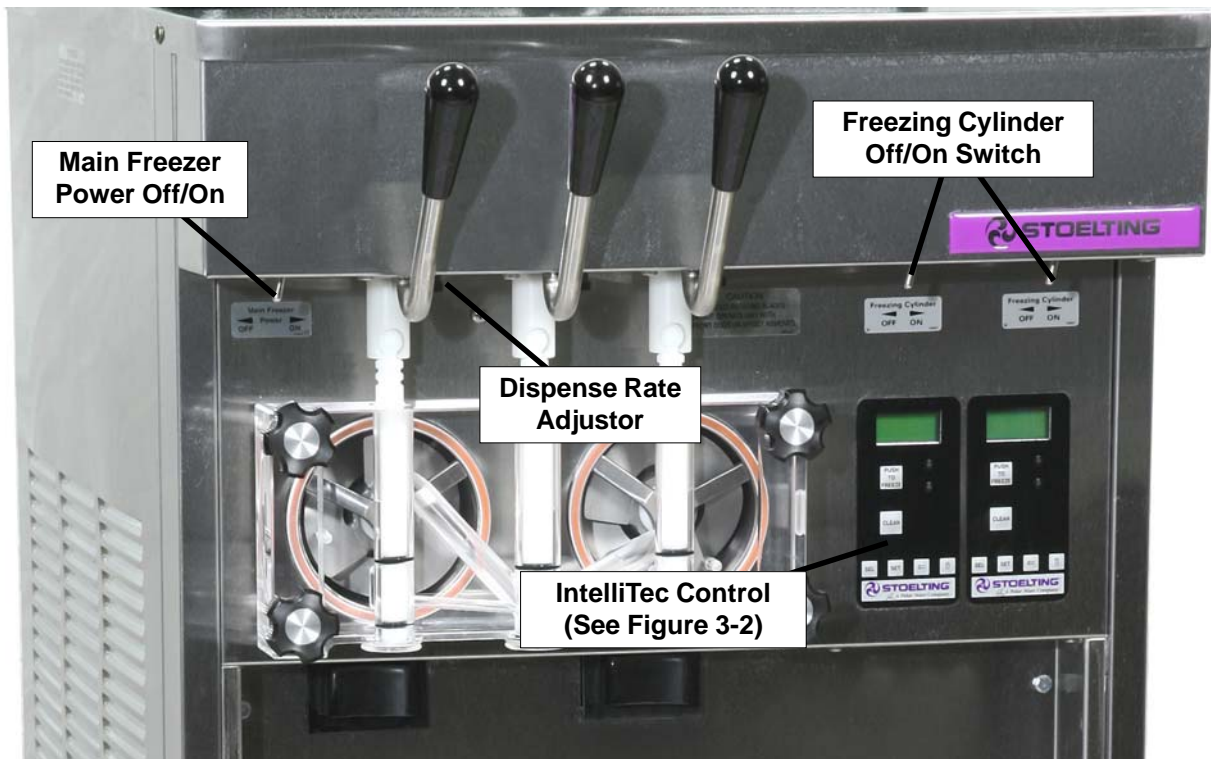

**Figure 3-1 Machine Controls**

### A. MAIN FREEZER POWER SWITCH

The Main Freezer Power switch is a two position rocker switch that supplies power to the IntelliTec control, freezing cylinder circuits and hopper refrigeration system. When the switch is placed in the ON position, the hopper refrigeration system will run until the preset temperature is reached; then it will cycle ON and OFF to maintain that temperature.

### B. FREEZING CYLINDER OFF/ON SWITCH

The Freezing Cylinder OFF/ON switch is a two position toggle switch used to supply power to the freezing cylinder control circuit. When the switch is in the OFF position, the freezing cylinder's refrigeration system and auger will not operate. When the switch is in the ON position, the machine will be operational.

### C. SPIGOT SWITCH

The spigot switch is mounted to the spigot cam assembly behind the header panel. When the spigot is opened to dispense product, the spigot switch opens and the "Serve Mode" begins.

### D. DISPENSE RATE ADJUSTOR

The dispense rate adjustor is located under the header panel, to the immediate right of the spigot handles. Turning the knob counterclockwise will decrease the dispense rate.

### E. PUSH TO FREEZE BUTTON

The PUSH TO FREEZE button is a membrane or snap switch used to initiate "Serve Mode".

#### NOTE

*After the PUSH TO FREEZE button is pressed, the drive motor starts. After a 3-second delay, the compressor will start.*

### F. LEDS

The membrane switch (touchpad) features two lights: a green LED and an amber LED. The green LED is lit during "Serve Mode". During freeze down, it is not lit. When product consistency approaches 75% in the freezing cylinder, the green LED flashes. The amber LED is on during all other modes. Both LEDs alternatively flash if an error occurs or if the freezing cylinder is off.

### G. CLEAN BUTTON

The CLEAN button is a membrane, or snap switch. When the button is pressed, the freezing cycle stops and the drive motor will start. A CLEAN message will display on the LCD screen along with a 5-minute countdown timer. To exit the CLEAN mode, turn the Freezing Cylinder OFF/ON switch to the OFF position or press the CLEAN button again. If the machine is left in CLEAN for more than 20 minutes, an error code (E4) will be displayed on the display panel. Place the Freezing Cylinder OFF/ON switch in the OFF position and back in the ON position to clear this error.



Figure 3-2 IntelliTec Control

### H. DRIVE MOTOR OVERLOAD

The internal drive motor overload will trip if the drive motor is overloaded. It will reset after approximately 10-12 minutes. If the drive motor continues to trip, refer to Troubleshooting in Section 7.

### I. MIX LOW LIGHT INDICATOR

A MIX LOW message will appear on the LCD display to alert the operator of a low mix condition. The message will display when there is approximately one gallon of mix left in the hopper. When the MIX LOW message is displayed, refill the hopper immediately.

### L. MENU NAVIGATION BUTTONS

The Menu Navigation Buttons allow the user to display information regarding the machine's status of operation as well as adjust product consistency (Fig. 3-2).

**Selection Button (SEL)** The SEL button is used in combination with the up arrow button to enter into the settings of the IntelliTec control. This button is also used to navigate through the control settings menu.

**Set Button (SET)** The SET button is used to save a change made to the product consistency setting. It is also used to save changes when modifying control settings.

**Left Arrow Button (←)** If the left arrow button is pressed for 5 seconds, the display will remain lit. To turn the light off, press the left arrow button for 5 seconds. The left arrow button is used primarily to navigate through the control settings.

**Up Arrow Button (↑)** After pressing the SET button, the up arrow button will change the value of the product consistency setting. This button is also used to navigate through the control settings.

### 3.3 IMPORTANT INFORMATION REGARDING CLEANING AND SANITIZING

Soft serve machines require special consideration when it comes to food safety and proper cleaning and sanitizing.

The following information specifically covers issues for cleaning and sanitizing frozen dessert machines. This information is meant to supplement a comprehensive food safety program.

#### SOIL MATERIALS ASSOCIATED WITH FROZEN DESSERT MACHINES

**MILKFAT/BUTTERFAT** – As components of ice-cream/frozen custard mix, these soils will accumulate on the interior surfaces of the machine and its parts. Fats are difficult to remove and help attribute to milkstone buildup.

**MILKSTONE** – Is a white/gray film that forms on equipment and utensils that are exposed to dairy products. These films will accumulate slowly on surfaces because of ineffective cleaning, use of hard water, or both. Milkstone is usually a porous deposit, which will harbor microbial contaminants and eventually defy sanitizing efforts.

Once milkstone has formed, it is very difficult to remove. Without using the correct product and procedure, it is nearly impossible to remove a thick layer of milkstone.

(NOTE: general-purpose cleaners DO NOT remove milkstone.) This can lead to high bacteria counts and a food safety dilemma.

**IT IS BEST TO CONTROL MILKSTONE ON A DAILY BASIS BEFORE IT CAN BECOME A SIGNIFICANT FOOD SAFETY PROBLEM.**

In addition to food safety, milkstone can cause premature wear to machine parts, which can add to costs for replacement parts or possibly more expensive repairs if worn machine parts are not replaced once they have become excessively worn.

#### IMPORTANT DIFFERENCES BETWEEN CLEANING AND SANITIZING

##### CLEANING vs. SANITIZING

It is important to distinguish between cleaning and sanitizing. Although these terms may sound synonymous, they are not. BOTH are required for adequate food safety and proper machine maintenance.

##### CLEANING

- Is the removal of soil materials from a surface.
- Is a prerequisite for effective sanitizing.

##### NOTE

*An UNCLEAN surface will harbor bacteria that can defy sanitizing efforts.*

Bacteria can develop and resist sanitizing efforts within a layer of soil material (milkstone). Thorough cleaning procedures that involve milkstone removal are critical for operators of frozen dessert machines.

##### SANITIZING

- Kills bacteria.
- Can be effective on clean surfaces only.

##### NOTE

*Using a SANITIZER on an unclean surface will not guarantee a clean and safe frozen dessert machine.*

#### PROPER DAILY MAINTENANCE:

The Only Way to Assure Food Safety and Product Quality  
Proper daily maintenance can involve a wide variety of products and procedures. Overall, the products and procedures fall into three separate categories. (Please note that this is a brief overview intended for informational purposes only.)

1. **CLEANING** – This involves draining mix from the freezing cylinder and rinsing the machine with water. Next, a cleaner is run through the machine. Then, the machine is disassembled and removable parts are taken to the sink for cleaning.
2. **MILKSTONE REMOVAL** – Since most cleaners do not have the ability to remove milkstone, the use of a delimer becomes necessary. Although this procedure may not be needed on a daily basis, it will usually follow the cleaning procedure. It requires letting a delimer solution soak in the machine for an extended period. Individual parts are also soaked in a deliming solution for an extended period of time (more about delimers in Additional Information).
3. **SANITIZING** – After the machine has been cleaned and contains no milkstone, the machine is reassembled. Then a FDA-approved sanitizing solution is run through the machine to kill bacteria. The machine is then ready for food preparation.

As a recommended cleaner and sanitizer for your frozen dessert machine, STERA-SHEEN has proven to be one of the best daily maintenance products for:

- **CLEANING** – Thorough removal of all solids including butterfat and milk fat.
- **MILKSTONE REMOVAL** – Complete removal of milkstone.
- **SANITIZING** – FDA-approved no rinse sanitizer for food contact surfaces.

#### ADDITIONAL INFORMATION

##### THE USE OF DELIMERS

A delimer is a strong acid that has the ability to dissolve milkstone. This type of chemical may become necessary once high levels of milkstone have developed. While these products are very effective for removing HIGH levels of milkstone, they are not ideal for two reasons:

1. **PRODUCT SAFETY** – Strong acids are dangerous chemicals. Carefully follow safety instructions provided with delimer products.

2. **MACHINE DAMAGE** – Strong acids will attack metal and rubber causing premature wear of parts. The use of a delimer needs to be closely monitored to avoid damage to machine surfaces and parts.

With proper daily use of STERA-SHEEN or its equivalent, there is no need for the use of a DELIMER.

**DO NOT USE BLEACH**

- BLEACH HAS ABSOLUTELY NO CLEANING PROPERTIES.
- BLEACH IS CORROSIVE. It will damage components of the machine causing premature wear and metal corrosion.

**GENERAL PURPOSE CLEANERS**

General purpose cleaners do not have the ability to remove milkstone. Milkstone will become a problem if not remedied with additional products and procedures.

**THE USE OF CHLORINE TEST STRIPS**

“Test strips” are used to determine concentrations of active chlorine in sanitizing solutions. To use the strips, tear off a small portion and submerge it into the sanitizing solution. Then, compare the color change to the color key on the side of the test strip dispenser to determine the approximate chlorine concentration.

The ideal concentration of chlorine needs to be 100 ppm (as stated by the FDA).

**NOTE**

*Follow the directions on the container for proper concentration.*

Two main factors contribute to falling chlorine concentrations in a sanitizing solution.

1. **PRODUCT USE** – As the chlorine in the solution is being used, chlorine concentrations fall.
2. **TIME** – As time passes, small amounts of chlorine “evaporate” from the solution. (That is why you can smell it.)

Sanitizing solutions should not be allowed to fall below 100 ppm chlorine. New solutions should be mixed once old solutions become ineffective.

**3.4 DISASSEMBLY OF MACHINE PARTS**

 <b>WARNING</b>
<p>High voltage will shock, burn or cause death. The OFF-ON switch must be placed in the OFF position prior to disassembling for cleaning or servicing. Do not operate machine with panels removed.</p>

Before using the machine for the first time, complete machine disassembly, cleaning and sanitizing procedures need to be followed. Routine cleaning intervals and procedures must comply with the local and state health codes.

Inspection for worn or broken parts should be made at every disassembly of the machine. All worn or broken parts should be replaced to ensure safety to both the operator and the customer and to maintain good machine performance and a quality product. Check the wear line on the auger flights on a regular basis (Fig. 3-3) and replace as needed. Frequency of cleaning must comply with the local health regulations.



**Figure 3-3 Auger Flight Wear**

To disassemble the machine, refer to the following steps:

**A. DISASSEMBLY OF FRONT DOOR**

1. Turn the Main Freezer Power Off/On switch to the OFF position.
2. Remove the knobs on the front door.
3. Remove the front door by pulling it off the studs.
4. Remove the spigot through the bottom of the front door.
5. Remove all o-rings from parts by first wiping off the lubrication using a clean towel. Then squeeze the o-ring upward to form a loop (Fig. 3-4). Roll the o-ring out of the groove.

<b>CAUTION</b>
<p>Do not use any type of sharp object to remove the o-rings.</p>



**Figure 3-4 Removing O-Ring**

## B. DISASSEMBLY OF AUGER

1. Remove the front auger support and bushing.
2. Remove the auger assembly from the machine. Pull the auger out of the machine barrel slowly. As the auger is being pulled out, carefully remove each of the plastic flights with springs.
3. Keep the rear of the auger tipped up once it is clear of the freezing cylinder to prevent the rear seal assembly from dropping.
4. Wipe the spline lubricant off of the hex end of the auger with a paper towel. Remove the rear seal assembly (Fig. 3-5).
5. Unscrew the springs from the auger flights.



**Figure 3-5 Rear Seal Assembly**

## 3.5 CLEANING DISASSEMBLED PARTS

Disassembled machine parts require complete cleaning, sanitizing and air drying before assembling. Local and state health codes will dictate the procedure required. Some state health codes require a four sink process (pre-wash, wash, rinse, sanitize, air dry), while others require a three sink process (without the pre-wash step). The following procedures are a general guideline only. Consult your local and state health codes for the procedures required in your location.

- A. Prepare detergent water by mixing 2 oz. of Palmolive detergent or equivalent in 2 gallons of 90° to 110°F (32° to 43°C) water. Place all parts in the detergent solution and clean with provided brushes.
- B. Rinse all parts with clean 90° to 110°F (32° to 43°C) water.
- C. Wash the hopper and freezing cylinder with the 90° to 110°F (32° to 43°C) detergent water and brushes provided (Refer to Figure 3-6).



**Figure 3-6 Clean Hoppers**

- D. Clean the rear seal surfaces from the inside of the freezing cylinder with the 90° to 110°F (32° to 43°C) detergent water.

## 3.6 SANITIZING MACHINE PARTS

- A. Use Stera-Sheen or equivalent sanitizing solution mixed according to manufacturer's instructions to provide a 100 parts per million strength solution. Mix sanitizer in quantities of no less than 2 gallons of 90° to 110°F (32°C to 43°C) water. Any sanitizer must be used only in accordance with the manufacturer's instructions.
- B. Place all parts in the sanitizing solution for 5 minutes, then remove and let air dry completely before assembling in machine.

## 3.7 CLEANING THE MACHINE

The exterior should be kept clean at all times to preserve the luster of the stainless steel. A high grade of stainless steel has been used on the machine to ease cleanup. To remove spilled or dried mix, wash the exterior with 90° to 110°F (32°C to 43°C) detergent water and wipe dry.

Do not use highly abrasive materials, as they will mar the finish. A mild alkaline cleaner is recommended. Use a soft cloth or sponge to apply the cleaner. For best results, wipe with the grain of the steel.

- A. Clean the rear seal surface from inside of the freezing cylinder.
- B. Using sanitizing solution and the large barrel brush provided, sanitize the freezing cylinder by dipping the brush in the sanitizing solution and brushing the inside of the freezing cylinder.
- C. Remove the drip tray by pulling from the front panel. Clean and replace the drip tray.

### 3.8 ASSEMBLING MACHINE

To assemble the machine parts, refer to the following steps:

#### NOTICE

*Petrol-Gel sanitary lubricant or equivalent must be used when lubrication of machine parts is specified.*

#### NOTICE

*The United States Department of Agriculture and the Food and Drug Administration require that lubricants used on food processing equipment be certified for this use. Use lubricants only in accordance with the manufacturer's instructions.*

- A. Assemble all o-rings onto parts dry, without lubrication. Then apply a thin film of sanitary lubricant to exposed surfaces of the o-rings.
- B. Lubricate the rear seal area on the auger shaft with a thin layer of sanitary lubricant. Install the rear seal o-ring. Lubricate the outside of the rear seal o-ring with sanitary lubricant.
- C. Install the stainless steel rear seal adapter into the rear seal dry (without lubricant). Lubricate the inside metal surface of the rear seal adapter and install it onto the auger shaft. **DO NOT** lubricate the outside of the rear auger seal (Fig. 3-6).



**Figure 3-6 Lubricate Rear Seal**

- D. Lubricate the hex drive end of the auger with a small amount of spline lubricant. A small container of spline lubricant is shipped with the machine.
- E. Screw the springs onto the studs in the plastic flights. The springs must be screwed into the flights completely to provide proper compression.
- F. Install the two plastic flights onto the rear of the auger and insert it part way into the freezing cylinder.
- G. Install the remaining plastic flights, push the auger into the freezing cylinder and rotate slowly until the auger engages the drive shaft.

- H. Apply a thin layer of sanitary lubricant to the inside and outside of the auger support bushing. Install the bushing onto the auger support and install the auger support into the front of the auger. Rotate the auger support so that one leg of the support points straight up.
- I. Apply a thin layer of sanitary lubricant to the o-rings on the spigot body and install the spigot body through the bottom of the front door.
- K. Apply a thin film of sanitary lubricant to the door seal o-ring and fit it into the groove on the rear of the front door.
- M. Place the front door assembly on the mounting studs and the push front door against the machine carefully.
- N. Secure the front door to the machine by placing the knobs on the studs and tightening until finger tight. Do not overtighten. A proper o-ring seal can be observed through the transparent front door.

### 3.9 SANITIZING

Sanitizing must be done after the machine is clean and just before the machine is filled with mix. Sanitizing the night before is not effective. However, you should always clean the machine and parts after using it.

#### NOTE

*The United States Department of Agriculture and the Food and Drug Administration require that all cleaning and sanitizing solutions used with food processing equipment be certified for this use.*

When sanitizing the machine, refer to local sanitary regulations for applicable codes and recommended sanitizing products and procedures. The frequency of sanitizing must comply with local health regulations. Mix sanitizer according to manufacturer's instructions to provide a 100 parts per million strength solution. Mix sanitizer in quantities of no less than 2 gallons of 90°F to 110°F (32°C to 43°C) water. Allow sanitizer to contact the surfaces to be sanitized for 5 minutes. Any sanitizer must be used only in accordance with the manufacturer's instructions.

#### CAUTION

##### **Risk of Product Damage**

Avoid prolonged contact of sanitizer with machine parts. Sanitizer may cause corrosion of stainless steel parts if there is prolonged contact.

- A. Prepare 2 gallons of sanitizing solution following the manufacturer's instructions.
- B. Install the mix inlet regulator into the hopper.
- C. Pour the sanitizing solution into the hopper.

- D. Place the Main Power OFF/ON and Freezing Cylinder OFF/ON switches in the ON position. Press the CLEAN button.
- E. Check for leaks.
  1. Check for leaks at the front door seals.
  2. Check the drain tray located under the front door for leaks coming from the rear of the rear auger seal.
- F. Using a sanitized soft bristle brush (or equivalent) dipped in sanitizing solution, clean the hopper sides, mix inlet regulator and underside of the hopper cover.
- G. After five minutes, open the spigot to expel sanitizing solution. Drain all of the solution from the machine.
- H. When the solution has drained, press the CLEAN button to stop the auger and place the Main Power OFF/ON and Freezing Cylinder OFF/ON switches in the OFF position. Allow the freezing cylinder to drain completely.

The machine is now sanitized and ready for adding mix.

### 3.10 INITIAL FREEZE DOWN AND OPERATION

Every Stoelting soft serve machine needs to be set on site. The following adjustment will provide optimal product consistency while prolonging product life.

#### NOTE

*The machine is designed for correct operation in ambient temperatures between 50°F and 110°F. Temperatures out of that range may cause refrigeration problems and product quality issues.*

#### A. ADDING MIX

1. Sanitize the machine immediately before use.
2. Make sure the Freezing Cylinder OFF/ON switch is in the OFF position.
3. Fill the hopper with at least 2.5 gallons of mix.
4. Place a container under the spigot and open the spigot to allow the mix to flush out about 8 ounces (0.23 liters) of sanitizing solution and liquid mix. Close the spigot.

#### B. PREPARING THE INTELLITEC CONTROL

5. On the IntelliTec control, press and hold the SEL button for 8 seconds. While still holding the SEL button, press the up arrow (↑) button. The LCD will read "DISPLAY".
6. Press the left arrow (←) button once. The display will read "BASIC".
7. Press the up arrow (↑) button once. The display will read "CutOut amps".
8. Press the SET button. A cursor will start blinking under the far right digit.

9. Change the value to 8.0. Press the left arrow (←) button to move the cursor. Press the up arrow (↑) button to increase the digit. When a digit reaches 9, pressing the up arrow (↑) button again will change the value to 0.
10. After entering 8.0, press SET to save this value. The LCD will read "CutOut Set -- OK".
11. Press the SEL button. The LCD will read "CutOut amps 8.0".
12. Press the SEL button twice. The LCD will read "DISPLAY".
13. Press the up arrow (↑) button to navigate to the "°F" and "amps" readings.

#### C. INITIAL FREEZE DOWN

14. Press the PUSH TO FREEZE button.

#### NOTE

*After the drive motor starts, there is a 3-second delay before the compressor starts.*

15. As the product freezes, the "amps" value on the display will increase. When it reaches 2.8A, open the spigot, take a 6-8 ounce sample and measure the temperature. For most soft serve mixes, the desired temperature is between 19.0°F and 19.5°F.
16. Draw samples at every increase of 0.2A until reaching the desired consistency and temperature.

#### NOTE

*Show the sample to the customer and make sure it meets their required consistency and temperature.*

17. Record the "amps" value.
18. Place the Freezing Cylinder OFF/ON switch in the OFF position.

#### D. ADJUSTING THE INTELLITEC CONTROL

19. Press the SEL button. The display will read "DISPLAY".
20. Press the left arrow (←) button once. The display will read "BASIC".
21. Press the up arrow (↑) button once. The display will read "CutOut amps".
22. Change the value to the recorded value by pressing the SET button. A cursor will start blinking under the far right digit.
23. Press the left arrow (←) button to move the cursor. Press the up arrow (↑) button to increase the digit. When a digit reaches 9, pressing the up arrow (↑) button again will change the value to 0.
24. Press the SET button to save the value. The LCD will read "CutOut Set -- OK".
25. Press the SEL button. The LCD will read "CutOut amps" along with the programmed value from the previous step.

- 26. Press the SEL button three times. The LCD will read "EXITMENU".
  - 27. Press the up arrow (↑) button to exit the menu.
  - 28. Adjustment to the control is completed.
- E. SERVING PRODUCT**
- 29. Place the Freezing Cylinder OFF/ON switch in the ON position.
  - 30. Press the PUSH TO FREEZE button.
  - 31. When the product is at 75% consistency, the display will read "SERVE".
  - 32. For normal dispensing, move the spigot handle fully open.
  - 33. The machine dispenses product at a reasonable draw rate. If the machine is overdrawn, the result is a soft product or a product that will not dispense at all. If this occurs, allow the machine to run for approximately 30 seconds before dispensing more product. A dispense rate adjuster is located under the header panel, to the immediate right of the spigot handle. Turning the knob counterclockwise will decrease the dispense rate.
  - 34. Do not operate the machine when the MIX LOW message is displayed. Refill hopper immediately.

**NOTE**

*The machine has a standby and sleep mode. After a preset number of freezing cycles, it will enter the standby mode (followed by sleep mode) and remain there until someone draws product or presses the PUSH TO FREEZE button. In the sleep mode, the machine will keep the product below 41°F (5°C). Sleep modes do not take the place of cleaning and sanitizing. Federal, State, and local regulatory agencies determine frequency of cleaning and sanitizing.*

**3.11 NORMAL FREEZE DOWN AND OPERATION**

The following section contains the recommended operating procedures for the safe operation of the machine.

- A. Sanitize immediately before use.
- B. Make sure the Freezing Cylinder Off/On switch is in the OFF position.
- C. Fill the hopper with at least 2.5 gallons of mix.
- D. Place a container under the spigot and open the spigot to allow the mix to flush out about 8 ounces (0.23 liters) of sanitizing solution and liquid mix.
- E. Place the Freezing Cylinder OFF/ON switch in the ON position.
- F. Press the PUSH TO FREEZE button.

**NOTE**

*After the drive motor starts, there is a 3-second delay before the compressor starts.*

- G. When the product is at 75% consistency, the display will read "SERVE". Open the spigot to dispense product.
- H. The machine dispenses product at a reasonable draw rate. If the machine is overdrawn, the result is a soft product or a product that will not dispense at all. If this occurs, allow the machine to run for approximately 30 seconds before dispensing more product. A dispense rate adjuster is located under the header panel, to the immediate right of the spigot handle. Turning the knob counterclockwise will decrease the dispense rate.
- I. Do not operate the machine when the MIX LOW message is displayed. Refill the mix container immediately.

**NOTE**

*The machine has a standby and sleep mode. After a preset number of freezing cycles, it will enter the standby mode (followed by sleep mode) and remain there until someone draws product or presses the PUSH TO FREEZE button. In the sleep mode, the machine will keep the product below 41°F (5°C). Sleep modes do not take the place of cleaning and sanitizing. Federal, State, and local regulatory agencies determine frequency of cleaning and sanitizing.*

**3.12 MIX INFORMATION**

Mix can vary considerably from one manufacturer to another. Differences in the amount of butterfat content and quantity and quality of other ingredients have a direct bearing on the finished frozen product. A change in machine performance that cannot be explained by a technical problem may be related to the mix.

Proper product serving temperature varies from one manufacturer's mix to another. Mixes should provide a satisfactory product in the 20°F to 24°F range. Diet and low-carb mixes typically freeze to proper consistency at higher temperatures.

When checking the temperature, stir the thermometer in the frozen product to get an accurate reading.

Old mix, or mix that has been stored at too high a temperature, can result in a finished product that is unsatisfactory. To retard bacteria growth in dairy based mixes, the best storage temperature range is between 33° to 38°F (0.5° to 3.3° C).

## SECTION 4 MAINTENANCE AND ADJUSTMENTS

### 4.1 MACHINE ADJUSTMENT

This section is intended to provide maintenance personnel with a general understanding of the machine adjustments. It is recommended that any adjustments in this section be made by a qualified person.

### 4.2 PRODUCT CONSISTENCY ADJUSTMENT

The operator can adjust product consistency by modifying the Fine Adjustment setting on the membrane switch. This is the only adjustment that can be made by the operator without using a pass code key sequence. Product consistency fine adjustment allows a 0.4 amp maximum adjustment to the drive motor amp draw cutout. Increasing this setting will increase the drive motor amperage cutout and increase product consistency. Follow the instructions below to make fine adjustments to product consistency.

- A. Place the Main Freezer Power switch in the ON position.
- B. Press the SET button on the Control Panel once. Fine Adj will appear on the LCD screen.
- C. Press the up arrow button (↑) until the desired consistency setting is displayed. The higher the number, the firmer the product consistency. The control may be set from 1 to 9. The value increases by 1 each time the up arrow button is pressed. After the value reaches 9, numbering restarts at 0. The 0 setting cannot be set.
- D. Press the SET button once to save the setting and return to the current mode display.



Figure 4-1 Membrane Switch

### 4.3 LOCKING THE CONTROL PANEL

The IntelliTec control has a tamper proof mode to prevent unauthorized use. When set, all buttons on the control panel are disabled. Follow the instructions below to lock the control panel

- A. Press and hold the PUSH TO FREEZE button for at least 5 seconds.
- B. While still holding the PUSH TO FREEZE button, press the CLEAN button once.
- C. Release both buttons. An asterisk (\*) will appear on the bottom line of the display, indicating that the control is in the lock out mode.

#### NOTE:

*Repeat steps A, B, and C to unlock the control panel.*

### 4.4 OBTAINING READINGS AND MODIFYING SETTINGS (SERVICE PERSONNEL ONLY)

Readings and settings on the IntelliTec control are accessed through the IntelliTec Control Menu Settings (Refer to Figure 4-2). Locating machine readings and system function settings are completed using the up arrow (↑) and left arrow (←) buttons on the membrane switch. A printed IntelliTec Menu Settings sheet is located in the information pouch behind the header panel.

#### IntelliTec Control Readings

To obtain machine readings, locate the value on the machine's menu settings sheet and follow the steps below.

- A. Press and hold SEL button for 8 seconds. While still holding the SEL button, press the up arrow button (↑). The LCD Screen will read DISPLAY.
- B. Release both buttons.
- C. Press the up arrow button (↑) to navigate to the correct reading under DISPLAY or press the left arrow (←) button to navigate to the ERRCODES menu.
- D. Press the up arrow (↑) and left arrow (←) buttons to navigate through the rest of the readings as needed.
- E. When all readings have been obtained, press the up arrow button (↑) from ExitMenu to return to the current mode display.

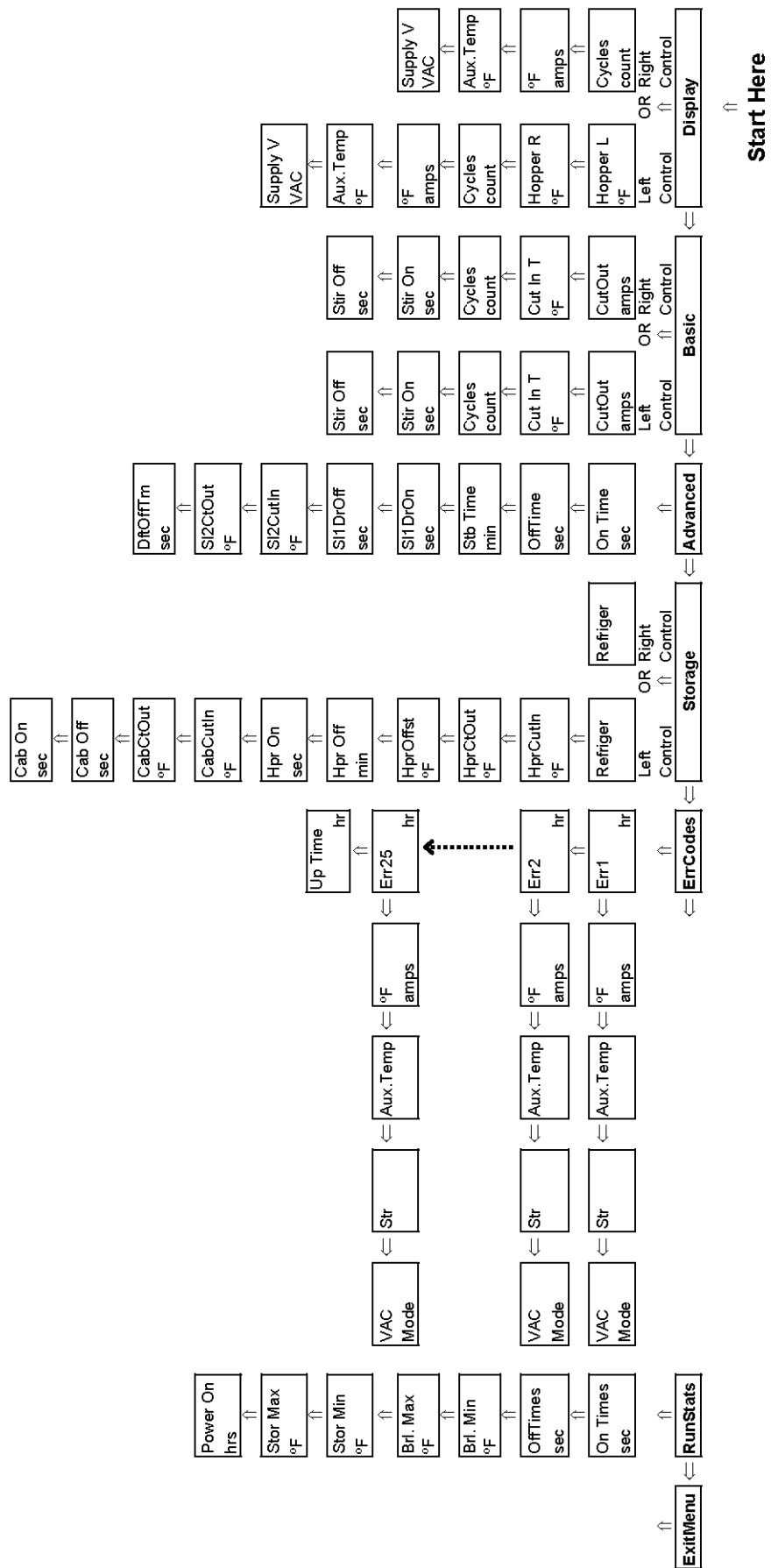

Figure 4-2 IntelliTec Control Menu Settings

## Modifying Control Settings

To change the value of a system function, locate the function on the IntelliTec Settings Menu and follow the steps below.

### IMPORTANT:

*Before making changes to any settings, record the original values. If the setting changes do not achieve desired results, revert settings to their original values.*

- A. Press and hold SEL button for 8 seconds. While still holding the SEL button, press the up arrow button (↑). The LCD Screen will read DISPLAY.
- B. Release both buttons.
- C. Press the left arrow button (←) to get to the correct menu (Basic, Advanced, or Storage).
- D. Press the up arrow button (↑) to navigate to the value that needs to be changed.
- E. Press SET button to enter edit mode.
- F. Press the up arrow button (↑) to change setting.
- G. Press SET button to save the setting and exit the edit mode.
- H. Press the up arrow (↑) and left arrow (←) buttons to navigate through the rest of the settings as needed.
- I. When all changes have been completed, press the up arrow button (↑) from ExitMenu to return to the current mode display.

## 4.5 READINGS (SERVICE PERSONNEL ONLY)

The IntelliTec control continuously monitors and records temperatures, voltages, amps, and error code details. Each of these readings are beneficial to service personnel when troubleshooting.

### DISPLAY READINGS

Following are the readings available under the DISPLAY menu:

#### Hopper L (°F) / Hopper R (°F)

The temperature of the left and right hoppers are constantly monitored by the IntelliTec control.

#### Cycles (count)

This reading counts down the number of cycles in the current "Serve Mode". The starting value is dependant upon the Cycles setting on the IntelliTec control.

#### °F and amps

Suction line temperature on the freezing cylinder and drive motor amps are available on the same screen to assist with setup and troubleshooting.

#### Aux. Temp (°F)

This reading provides the ambient temperature around the IntelliTec control.

#### Supply V (VAC)

A calculated input voltage is recorded.

### ERROR CODE READINGS

The following details are recorded under the ERRCODES menu for each of the last 25 error codes received:

#### Err1 (hours)

A numerical count of the last 25 error codes is recorded. When the 26th error has occurred the earliest error code is erased. A timer also begins when an error occurs. The timer records the number of hours since the error occurred. If power to the machine is interrupted, the timer will stop until power has been restored.

#### °F and amps

The suction gas temperature on the freezing cylinder and the drive motor amps are recorded at the time of the error.

#### Aux. Temp (°F)

Ambient temperature of the IntelliTec control is recorded at the time of the error.

#### Str (°F)

The storage temperature is recorded at the time of the error.

### VAC and Mode

A calculated input voltage and mode at which the error occurred are recorded. Following are descriptions of each mode:

Mode	Description
0	Start of freezing cycle
1	Compressor and drive motor on
2	Stir Cycle
3	Compressor off
4	"Standby Mode"
5	"Sleep 1 Mode"
6	"Sleep 2 Mode"
7	"Clean Mode"
8	Startup
9	Storage only refrigeration
10	Freezing cycle is shut down
11	Door safety switch triggered
12	High pressure cutout

### **Up Time (hours)**

This value is a record of the total time the machine has been in service. If power is interrupted, the timer will stop until power is restored. This timer does not reset.

### **RUN STATISTICS**

In addition to dynamic readings and recorded error code details, the IntelliTec control records rolling averages of run statistics. Following are the readings available under the RUNSTATS menu:

#### **On Times (sec)**

The control records the time of each freezing cycle and provides a rolling average.

#### **Off Times (sec)**

The control records the time between freezing cycles and provides a rolling average.

#### **Brl. Min (°F)**

The lowest average barrel temperature is recorded.

#### **Brl. Max (°F)**

The highest average barrel temperature is recorded.

#### **Stor Min (°F)**

The lowest average hopper or cabinet temperature is recorded.

#### **Stor Max (°F)**

The highest average hopper temperature is recorded.

#### **Power On (hrs)**

This value is a record of the time the machine has been in service. If power is interrupted, the timer will reset.

## **4.6 ADJUSTMENTS (SERVICE PERSONNEL ONLY)**

The following adjustments directly affect product consistency and length of time in "Serve Mode". The default settings have been created using a 5% milkfat soft serve mix and provide optimal product consistency while prolonging product life.

#### **CutOut (amps)**

It is recommended to change the CutOut value at initial startup and when changing mix types. Adjustments to this setting directly affect the length of the freezing cycle which changes product consistency. To properly set the CutOut value, refer to Section 3-10.

### **Cut In T (°F)**

After the consistency value has been determined, the Cut In T value can be adjusted. The Cut In T is the temperature of the refrigerant gas in the evaporator. Changing this setting changes the temperature at which the freezing cycle starts. This value along with the CutOut value determines the range of temperatures (or "temperature window") of the product. Decreasing the temperature decreases the temperature window and, under normal use, increases the amount of freezing cycles. This creates a greater chance of product breakdown by stirring the product often. Increasing the Cut In T increases the temperature window which decreases freezing cycles and increases the chance of heat shock within the product.

### **Cycles (count)**

This setting determines the number of freezing cycles during "Serve Mode". Increasing the value will increase the total time in "Serve Mode". Factory default is 16 cycles. This results in "Serve Mode" lasting about 2 to 2-1/2 hours without the PUSH TO FREEZE button being pressed or a spigot handle being pulled. If the PUSH TO FREEZE button is pressed or the spigot handle is pulled at any time during "Serve Mode", the Cycles count will reset.

## **4.7 OTHER SETTINGS (SERVICE PERSONNEL ONLY)**

Changing any setting on the IntelliTec control will alter machine operation and affect the product temperature, consistency, or life. Refer to the IntelliTec Control System Settings sheet located in the information pouch behind the header panel of the machine. If any of the following settings on the IntelliTec control differ from the System Settings sheet, it is recommended to revert those settings to factory defaults.

#### **Stir On (sec)**

Adjustments to this setting affect the amount of time the auger rotates in the stir cycle. The stir cycle occurs in "Serve Mode", "Standby Mode", and "Sleep 2 Mode".

#### **Stir Off (sec)**

Adjustments to this setting affect the time between stir cycles. The stir cycle occurs in "Serve Mode", "Standby Mode", and "Sleep 2 Mode".

#### **On Time (sec)**

Increasing this value will increase the length of the freezing cycle during "Standby Mode" and result in a decrease of average product temperature in the barrel.

### Off Time (sec)

Increasing this value will increase the time between freezing cycles in "Standby Mode" and result in an increase of product temperature in the barrel.

### Stb Time (sec)

This setting determines the total amount of time in "Standby Mode".

### SI1DrvOn (sec)

Adjustments to this setting affect the amount of time the auger rotates in the stir cycle. This stir cycle only occurs in "Sleep 1 Mode".

### SI1DrOff (sec)

Adjustments to this setting affect the time between stir cycles. The stir cycle only occurs in "Sleep 1 Mode".

### SI2CutIn (°F)

Changing this setting affects the temperature at which the freezing cycle starts in "Sleep 2 Mode".

### SI2CtOut (°F)

Changing this setting affects the temperature at which the freezing cycle stops in "Sleep 2 Mode".

### DftOffTm (sec)

In "Serve Mode", this value determines the maximum time without a freezing cycle. If this value is met, a freezing cycle will start. In the event of a freezing cylinder temperature sensor failure, this value affects the amount of time between freezing cycles during "Serve Mode".

### Refriger

This setting changes how the control handles the storage refrigeration cycle. The setting for the E131 and F131 is 2 Hopper on the left control and None on the right control.

### HprCutIn (°F)

This setting determines the temperature at which the hopper refrigeration cycle starts. This setting is only available on the left control.

### HprCtOut (°F)

This setting determines the temperature at which the hopper refrigeration cycle stops. This setting is only available on the left control..

### Hpr Off (min)

If the temperature sensor in the hopper fails, this setting determines the time between hopper refrigeration cycles. This setting is only available on the left control..

### Hpr On (sec)

If the temperature sensor in the hopper fails, this setting determines the length of the hopper refrigeration cycle. This setting is only available on the left control..

## 4.8 DRIVE BELT TENSION ADJUSTMENT

To check belt tension, refer to Figure 4-4 and follow the steps below:



### WARNING

#### Hazardous voltage

The Main Freezer Power switch must be placed in the OFF position when disassembling for servicing. The freezer must be disconnected from electrical supply before removing any access panel. Failure to disconnect power before servicing could result in death or serious injury.

- A. Remove the back panel.
- B. Use a Burroughs Belt Tension Gauge to set the tension for the drive belt. Set the belt tension to 35-40 lbs.
- C. If an adjustment is necessary, loosen the four motor plate retaining nuts, adjust belt tension then retighten the four nuts.
- D. Using a straightedge, check that the drive motor pulley is aligned with the speed reducer pulley. Align the pulley if necessary.

### NOTE

*Belt life will be increased if new drive belts are tightened after two or three weeks of operation.*

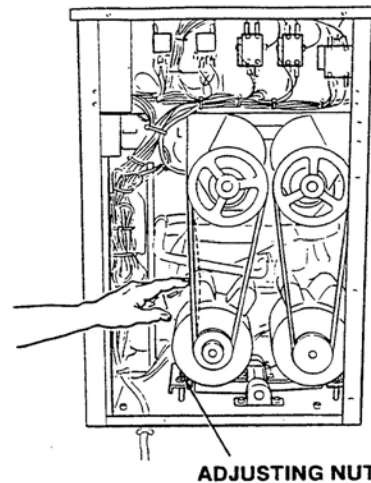

Figure 4-4 Belt Tension Adjustment

## 4.9 CONDENSER CLEANING

The air-cooled condenser is a copper tube and aluminum fin type. Condensing is totally dependent upon airflow. A plugged condenser filter, condenser, or restrictions in the louvered panel will restrict airflow. This will lower the capacity of the system and damage the compressor. The condenser must be kept clean of dirt and grease. The machine must have a minimum of 3" (7.5 cm) of ventilation

on the right and left sides of the unit for free flow of air. Make sure the machine is not pulling over 100° F (37° C) air from other equipment in the area.

The water-cooled condenser is a tube and shell type. The condenser needs a cool, clean supply of water to properly cool the machine, inlet and discharge lines must be 3/8" I.D. minimum.

The condenser and condenser filter require periodic cleaning. To clean, refer to the following procedures.

1. Remove the Phillips head screw from the bottom of the right side panel, and then slide the panels down and out.
2. To remove the condenser filter, grasp the top and pull off. Visually inspect for dirt. If the filter is dirty, shake or brush excess dirt off the filter and wash in warm, soapy water. Once the filter is clean rinse thoroughly in warm, clear water and shake dry, taking care not to damage the filter in any way (Figure 4-5).



**Figure 4-5 Condenser Filter Removal**

3. Visually inspect the condenser for dirt by shining a light through the coil from the back (inside) of the condenser.
4. If the condenser is dirty, place a wet towel over the outside of the condenser.
5. Using compressed air or a CO2 tank, blow out the dirt from the inside of the condenser. Most of the dirt will cling to the wet towel.

**NOTE**

*If the condenser is not kept clean, refrigeration efficiency will be lost.*

## 4.10 PREVENTATIVE MAINTENANCE

It is recommended that a preventative maintenance schedule be followed to keep the machine clean and operating properly. The following steps are suggested as a preventative maintenance guide.

The United States department of agriculture and the food and drug administration require that lubricants used in food zones be certified for this use. Use lubricants only in accordance with the manufacturer's instructions.

- A. Daily checks  
Check for any unusual noise or condition and repair immediately.
- B. Monthly checks  
Check the condenser filter for dirt. (Refer to section 4.9).
- C. Quarterly Checks  
Check drive belts for wear and tighten belts if necessary. (Refer to section 4.8)

## 4.11 EXTENDED STORAGE

Refer to the following steps for storage of the machine over any long period of shutdown time:

- A. Clean thoroughly with warm detergent all parts that come in contact with mix. Rinse in clear water and dry all parts. Do not sanitize.

**NOTE**

*Do not let cleaning solution stand in machine barrel or mix pump during the shutdown period.*

- B. Remove, disassemble, and clean the front door, and auger shaft. Leave disassembled during the shutdown period.
- C. Place the auger flights and auger support bushing in a plastic bag with a moist paper towel. This will prevent them from becoming brittle if exposed to dry air over an extended period of time (over 30 days).
- D. For water-cooled machines that are left in unheated buildings, or buildings subject to freezing, the water must be shut off and disconnected. Disconnect the water inlet fitting. The fitting is located at the rear of the machine. Run the compressor for 2 - 3 minutes to open water valve (the front door must be attached for the compressor to run). Blow out all water through water inlet. Drain the water supply line coming to the machine. Disconnect the water outlet fitting.
- E. Place the Main Freezer Power OFF/ON switch in the OFF position.
- F. Disconnect the machine from the source of electrical supply.

# SECTION 5 REFRIGERATION SYSTEM

## 5.1 REFRIGERATION SYSTEM

The E131OT2 and F131OT2 refrigeration systems have two functions:

Medium-Temperature - Maintaining mix temperature in the hopper.

Low-Temperature - Producing and maintaining high quality product in the freezing cylinders.

The system is designed for efficient use with R404A refrigerant. The proper charge is indicated on the information plate.

## 5.2 REFRIGERANT RECOVERY AND EVACUATION

Refer to the following procedures to properly recover and evacuate the refrigeration system. Do not purge refrigerant into the atmosphere.

## NOTE

*For qualified service personnel only. Anybody working with refrigerants must be certified as a Technician TYPE I as required by 40 CFR 82 Subpart F and hold all State and/or local refrigerant handling certifications. In addition, all handling, storage, and disposal of refrigerants must be in accordance with Environmental Protection Agency (EPA) guidelines and standards and all State and local guidelines and standards.*



## WARNING

### Hazardous voltage

The Main Freezer Power switch must be placed in the OFF position when disassembling for servicing. The machine must be disconnected from electrical supply before removing any access panel. Failure to disconnect power before servicing could result in death or serious injury.

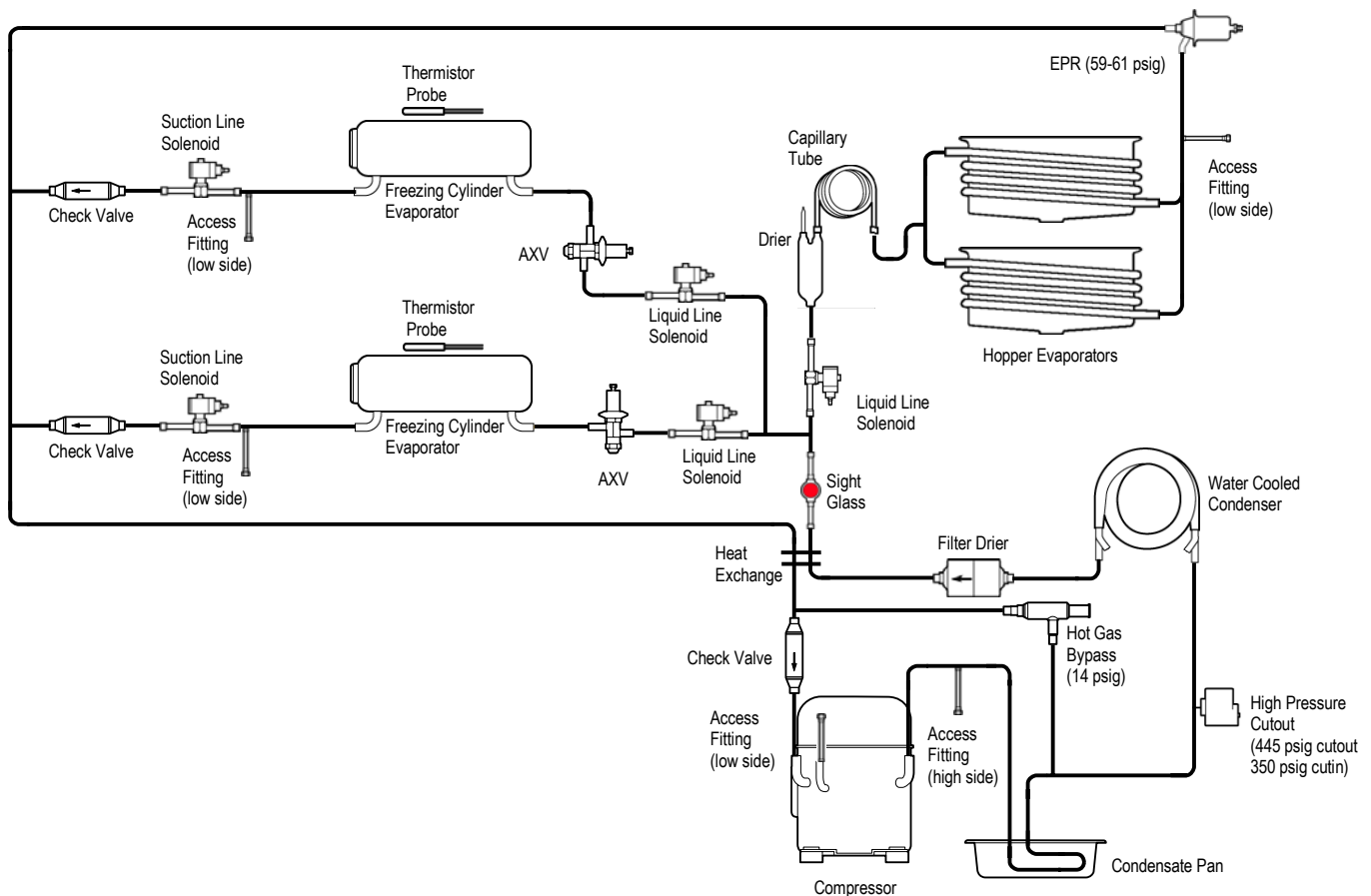

**Figure 5-1 Water Cooled Refrigeration System**

## A. REFRIGERANT RECOVERY

1. Disconnect the machine from electrical supply before removing any panels for servicing.
2. Remove all panels.
3. Connect the recovery unit unit to the suction and discharge service valves of the compressor.
4. Locate the compressor contactor behind the right side panel and disconnect the two blue wires at terminal #82 (Refer to Figure 5-3).



**Figure 5-2 Disconnect Compressor Coil**

5. Wrap electrical tape around disconnected terminal to insulate it.
6. Remove belts from the pulleys to allow drive motors to spin freely.
7. Connect power to the machine.
8. Turn the Main Power OFF/ON switch and Freezing Cylinder OFF/ON switches to the ON position.
9. Press the Push To Freeze button on both IntelliTec controls. This will energize the solenoid valves.

### CAUTION

The solenoid valves must be energized to allow all refrigerant to be recovered and to prevent injury when brazing.

10. Operate the recovery unit per manufacturer's instructions

### NOTE

*If recovery is not completed after 30 minutes, press the Push To Freeze buttons again. This will keep the solenoid valves open.*

## B. EVACUATING THE REFRIGERATION SYSTEM

1. Close any open ports in the refrigeration system.
2. Connect a vacuum gauge to one of the Schrader valves next to an evaporator.
3. Connect the evacuation unit to the suction and discharge service valves of the compressor.
4. Locate the compressor contactor behind the right side panel and disconnect the two blue wires at terminal #82.
5. Wrap electrical tape around disconnected terminal to insulate it.
6. Remove belts from the pulleys to allow drive motors to spin freely.
7. Connect power to the machine.
8. Turn the Main Power OFF/ON switch and Freezing Cylinder OFF/ON switches to the ON position.
9. Press the Push To Freeze button on both IntelliTec controls. This will energize the solenoid valves
10. Evacuate the system until the gauge reads 300 microns of mercury (300 $\mu$  Hg) for 5 continuous minutes.

### NOTE

*If evacuation is not completed after 30 minutes, press the Push To Freeze button again. This will keep the solenoid valves open.*

11. If the system will not maintain a standing vacuum test with the vacuum pump off (gauge increases towards atmosphere), find the leak, fix it, and evacuate again.

## 5.3 REFRIGERANT CHARGING

Refer to the following procedures to properly charge the refrigeration system. Stoelting recommends liquid refrigerant charging.

### NOTE

*For qualified service personnel only. Anybody working with refrigerants must be certified as a Technician TYPE I as required by 40 CFR 82 Subpart F and hold all State and/or local refrigerant handling certifications. In addition, all handling, storage, and disposal of refrigerants must be in accordance with Environmental Protection Agency (EPA) guidelines and standards and all State and local guidelines and standards.*



## WARNING

### Hazardous voltage

The Main Freezer Power switch must be placed in the OFF position when disassembling for servicing. The machine must be disconnected from electrical supply before removing any access panel. Failure to disconnect power before servicing could result in death or serious injury.

- A. Ensure the electrical supply has been removed before continuing.
- B. If the system has been opened or if there was a leak, refer to Section 5.2 - Refrigerant Recovery and Evacuation to evacuate the system prior to charging.
- C. Refer to machine's information plate for total charge requirements.

### NOTE

*The refrigeration systems of the E131 & F131 are critically charged. Be sure to charge the system to the weight listed on the machine's information plate.*

- D. For liquid refrigerant charging, connect refrigerant cylinder to the discharge Schrader valve of the compressor.
- E. Energize all five solenoid valves. There are three liquid line solenoids and two suction line solenoids.
- F. Add the proper amount of refrigerant according to the machine's information plate.

## 5.4 COMPRESSOR

The E131 and F131 have hermetic reciprocating compressors (Refer to Figure 5-3).

### A. WINDING TEST

To test the compressor motor windings for possible problems, perform the following steps:

- A. Disconnect the machine from electrical supply before removing any panels for servicing.

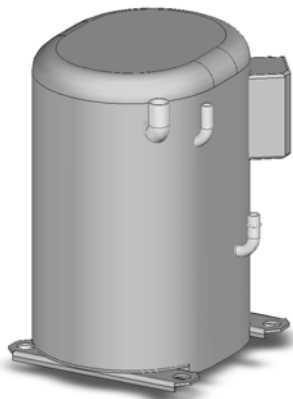

**Figure 5-3 Compressor**

- B. Remove the front panel.
- C. Remove the protective cover from the compressor terminals. Disconnect the three terminals; C (common), R (run), and S (start).
- D. Connect an ohmmeter to the C and R terminals on the compressor. Resistance through the run winding should be as follows:  
E131:  $1.41\Omega \pm 10\%$   
F131:  $1.16\Omega \pm 10\%$
- E. Connect an ohmmeter to the C and S terminals on the compressor. Resistance through the start winding should be as follows:  
E131:  $2.65\Omega \pm 10\%$   
F131:  $3.10\Omega \pm 10\%$
- F. To check if windings are shorted to ground, connect one ohmmeter lead to a bare metal part on the compressor (such as any copper line leading to or from the compressor) and check terminals C, R, and S.

### NOTE

*The compressor is equipped with an internal overload protector. If the compressor is warm and ohmmeter readings indicate an open winding, allow up to one hour for overload to reset.*

### B. COMPRESSOR REMOVAL

- A. Disconnect the machine from electrical supply before removing any panels for servicing.
- B. Remove the front panel.
- C. Remove the protective cover from the compressor terminals and disconnect the wires.
- D. Recover refrigerant charge per the instructions in Section 5.2.
- E. Leave the suction and discharge ports open to prevent pressure buildup during compressor removal.
- F. Remove six inches of insulating tubing on the suction line going to the compressor and unsweat the suction and discharge line from the compressor.
- G. Remove the four nuts and washers from the base of the compressor.
- H. Remove the compressor through the front of the machine.
- I. Remove the four rubber compressor mounts from the compressor.
- J. Crimp and braze all open ports of the old compressor.

### NOTE

*A compressor returned to Stoelting with any open ports will void the warranty. ALWAYS crimp and braze ports on a compressor that has been removed.*

## C. COMPRESSOR INSTALLATION

- A. Make sure the machine is disconnected from the electrical supply before removing any panels for servicing.
- B. Install the four rubber mounts on the compressor.
- C. Install the compressor into the machine, fitting the base over the four bolt holes.
- D. Install the four washers and nuts onto the bolts and tighten securely.
- E. Remove all tubing plugs from the replacement compressor.

### NOTE

*The compressor plugs protect the compressor from moisture in the air. Do not remove the plugs until you are ready to install. The compressor must not be opened to the atmosphere for more than 10 minutes.*

- F. Leave the suction and discharge ports open to prevent pressure buildup. Braze the suction and discharge line to the compressor.
- G. Connect the wires to the compressor terminals.
- H. Replace the drier per the instructions in Section 5.9.
- I. Evacuate the system per the instructions in Section 5.2
- J. Recharge the system per the instructions in Section 5.3.
- K. Replace the insulating tubing on the suction line.

## 5.5 CONDENSER

The E131 and F131 come with either an air-cooled or a water-cooled condenser. The capacity of the machine is directly related to keeping the condenser clean and free of debris.

The air-cooled condenser is a copper tube and aluminum fin type. The machine must have a minimum of 3" of clearance on both sides for proper air flow.

The water-cooled condenser is a tube and shell type. This condenser requires cool, clean water to function properly. Inlet and discharge lines must be 3/8" ID minimum.

### CONDENSER TESTING

The condenser can be checked for leaks using the bubble test or using a leak detector.

## 5.6 VALVES

### A. AUTOMATIC EXPANSION VALVE (AXV)

The Automatic Expansion Valve (AXV) is used to meter the refrigerant to the freezing cylinder evaporator. It does so by maintaining a constant pressure in the evaporator. The self-regulating AXV is preset by the manufacturer and adjustment is not recommended. Figure 5-4.

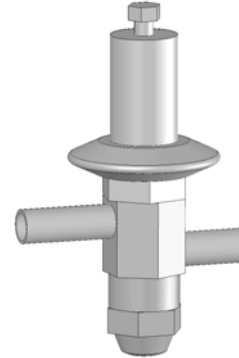

Figure 5-4 AXV

### AXV TESTING & ADJUSTMENT

When testing an AXV, isolate the evaporator from the other evaporators:

To test the left side AXV, place the right side freezing cylinder switch in the OFF position and disconnect the solenoid for the hopper evaporator.

If checking the right side AXV, place the left side freezing cylinder in the OFF position.

- A. Connect a gauge to the Schrader valve on the suction line next to the evaporator.
- B. Connect a thermocouple to the suction line next to the evaporator.
- C. Immediately before the refrigeration cycle ends, the gauge should read 22-24 psig. This reading is based on a full load in the freezing cylinder and an ambient temperature of 70°F.
- D. If the pressure reading is higher than expected, check to see if there is an overcharge of refrigerant.
- E. If the pressure reading is lower than expected, check to see if there is a low refrigerant charge or if there is a restriction in the system.

## NOTE

*The AXV is the LAST component to adjust in the refrigeration system.*

- F. The AXV can be adjusted after the steps above are completed. When adjusting, do not turn the valve over 1/4 turn (90°). Turn the valve stem clockwise to decrease the evaporator pressure or counterclockwise to increase the evaporator pressure.

## AXV REMOVAL

- A. Disconnect the machine from electrical supply before removing any panels for servicing. Remove the front panel.
- B. Recover refrigerant charge per instructions in Section 5.2.
- C. Leave the suction and discharge ports open to prevent pressure buildup during AXV removal.
- D. Remove any insulation from the AXV and immediate surrounding lines.
- E. Apply a heat sink (wet cloth) to the valve dome (Figure 5-5).
- F. Unsweat the AXV and remove.



Figure 5-5 AXV Removal

## AXV REPLACEMENT

To replace the AXV, perform the following procedures:

- A. Position the AXV, with a heat sink, into the system.
- B. With the suction and discharge ports open, braze the AXV into the system.
- C. Remove the heat sink from the AXV.

- E. Replace insulation to the AXV and surrounding lines.
- F. Replace the drier per the instructions in Section 5.9.
- G. Evacuate the system per the instructions in Section 5.2.
- H. Recharge the system per the instructions in Section 5.3.

## B. CHECK VALVE

The machine has 3 magnetic check valves (Refer to Figure 5-6). Each valve is positioned in the suction line and prevents backflow of refrigerant into the evaporator. If there is reversed flow, the product in the freezing cylinder softens and liquid refrigerant can flood into the compressor on startup.

If a check valve needs to be replaced, use a heat sink (wet cloth) when installing the new valve to prevent damage.



Figure 5-6 Check Valve

## C. HIGH PRESSURE CUTOUT

The high pressure cutout stops the compressor in water cooled machines if the discharge pressure reaches 445 psig.

### HIGH PRESSURE CUTOUT TEST

- A. Connect a gauge to the Schrader valve on the discharge line.
- B. Disconnect cooling by shutting off the water supply.
- C. High pressure cutout should trip when pressure reaches 445 psig  $\pm$ 9.

### HIGH PRESSURE CUTOUT REMOVAL

- A. Remove the left side and front panels.
- B. Recover refrigerant charge per instructions in Section 5.2.
- C. Leave the suction and discharge ports open to prevent pressure buildup during removal.
- D. Unsweat capillary tube from suction line.
- E. Disconnect terminals from high pressure cutout.

## HIGH PRESSURE CUTOUT REPLACEMENT

- A. With the suction and discharge ports open, braze the capillary tube to the discharge line.
- C. Replace the drier per the instructions in Section 5.9.
- D. Braze bulb into place on suction line.
- E. Evacuate the system per the instructions in Section 5.2.
- F. Recharge the system per the instructions in Section 5.3.
- G. Connect the terminals to the high pressure cutout.
- H. Attach the high pressure cutout using the two screws with star washers.

## D. HOT GAS BYPASS

The hot gas bypass valve is installed parallel to the compressor and helps to regulate the compressor temperature (Refer to Figure 5-7). When the cab evaporator is the only part of the system requiring refrigerant, the bypass valve will allow discharge gas to bypass into the suction line to prevent liquid refrigerant from entering the compressor.

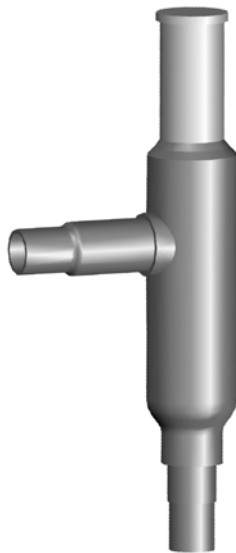

Figure 5-7 Hot Gas Bypass

## HOT GAS BYPASS ADJUSTMENT

Adjustment to the hot gas bypass must be made when the hopper refrigeration is the only part of the system running.

### NOTE

*Before adjusting the hot gas bypass, check the EPR valve and adjust if necessary.*

- A. Turn the Main Power OFF/ON switch and both Freezing Cylinder OFF/ON switches to the OFF position.

## NOTE

*If the machine does not have a Main Power switch, turn the right side Freezing Cylinder switch OFF and listen to make sure the left freezing cylinder is not calling for refrigeration.*

- B. Connect a gauge to the Schrader valve on the suction line next to the compressor.
- C. Wait until the gauge stops moving.
- D. Unscrew the seal cap from the top of the valve.
- E. Using a 5/16" Allen wrench, adjust the valve counterclockwise to decrease pressure and clockwise to increase pressure. (Refer to Figure 5-8)

## NOTE

*Each 360° turn will change the pressure about 6 psig.*

- F. Adjust the hot gas bypass valve to 14 psig  $\pm$ 1.
- G. Wait 2 minutes to ensure pressure remains stable.
- H. Hand-tighten seal cap to valve.



Figure 5-8 Hot Gas Bypass Adjustment

## HOT GAS BYPASS REMOVAL

- A. Remove the left side panel and the front panel.
- B. Recover refrigerant charge per instructions in Section 5.2.
- C. Remove insulation around hot gas bypass and tubing.
- D. Leave the suction and discharge ports open to prevent pressure buildup during hot gas bypass removal.
- E. Apply a heat sink (wet cloth) to the hot gas bypass.
- F. Unsweat the hot gas bypass and remove.

## HOT GAS BYPASS REPLACEMENT

To replace the hot gas bypass, perform the following procedures:

- A. Apply a heat sink (wet cloth) to the hot gas bypass.
- B. With an open port, braze the hot gas bypass into the system.
- C. Remove the heat sink from the hot gas bypass.
- D. Replace the filter drier. Refer to Section 5.8 for details.
- E. Evacuate and recharge system per instructions in Section 5.2.

## E. EVAPORATOR PRESSURE REGULATOR (EPR)

There is one EPR in the refrigeration system (Refer to Figure 5-9). It is located on the suction line of the hopper evaporators and regulates evaporator refrigerant pressure.

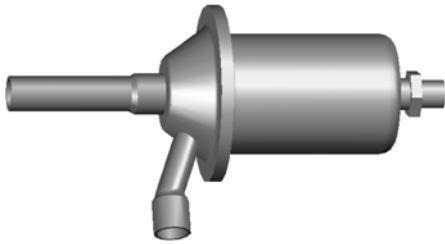

Figure 5-9 EPR Valve

## EPR TEST AND ADJUSTMENT

Adjustment to the EPR must be made when the hopper refrigeration is the only part of the system running

- A. Place the Main Power OFF/ON switch and both Freezing Cylinder OFF/ON switches in the OFF position.
- B. Connect a gauge to the Schrader valve on the suction line between the hopper evaporators and the EPR.
- C. Place the Main Power OFF/ON switch to the ON position and place both Freezing Cylinder OFF/ON switches in the OFF position.
- D. If the gauge does not read  $60 \pm 2$  then adjustment is needed.
- F. Remove the plastic cap and loosen the locknut on the EPR. Using a small screwdriver, turn the adjustment screw counterclockwise  $1/2$  turn, then adjust as necessary. Turn the valve stem clockwise for higher pressure or counterclockwise for lower pressure.
- G. Allow the system to stabilize for 5 minutes to ensure pressure remains stable.

## EPR REMOVAL

- A. Remove the left side panel and front panel.
- B. Recover refrigerant charge per instructions in Section 5.2.
- C. Leave the suction and discharge ports open to prevent pressure buildup during EPR removal.
- D. Unsweat the EPR and remove.

## EPR REPLACEMENT

To replace the EPR, perform the following procedures:

- A. Apply a heat sink (wet cloth) to the EPR.
- B. With an open port, braze the EPR into the system.
- C. Remove the heat sink from the hot gas bypass.
- D. Replace the filter drier. Refer to Section 5.8 for details.
- E. Evacuate and recharge system per instructions in Section 5.2.

## F. WATER VALVE (WATER COOLED MODELS ONLY)

The water valve monitors refrigerant pressure and opens on an increase of pressure. The opening point pressure is the refrigerant pressure required to lift the valve disc off the valve seat. (Figure 5-12)

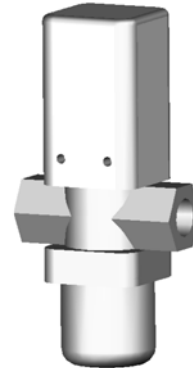

Figure 5-10 Water Valve

## WATER VALVE ADJUSTMENT

- A. Remove the back panel.
- B. Connect a gauge to the compressor discharge Schrader valve.
- C. Connect the machine to the electrical supply, start the refrigeration cycle, and read the pressure.
- D. The proper gauge reading should be 225-235 psig. The exit water temperature should be 95-107°F.
- E. If the water temperature and high side pressure are too low, the opening point pressure should be increased to slow the water flow. Turn the adjustment screw counterclockwise.
- F. If the water temperature and high side pressure are too high, the opening point pressure should be decreased to increase the flow of water. Turn the adjustment screw clockwise.

## WATER VALVE REMOVAL

The water valve is connected to the refrigeration system by capillary tube brazed to the discharge line.

- A. Turn off and disconnect the water supply. Blow out the water lines with compressed air or CO<sub>2</sub>.
- B. Recover refrigerant charge per instructions in Section 5.2.
- C. Leave the suction and discharge ports open to prevent pressure buildup during water valve removal.
- D. Unsweat the capillary tube from the discharge line.
- E. Remove the clamps from the water lines at the valve.
- F. Remove the two screws holding the water valve to the frame and remove the valve.

## WATER VALVE REPLACEMENT

To replace the water valve, perform the following procedures:

- A. Position the water valve and attach to the frame using the two screws.
- B. Install the water lines onto the valve with hose clamps.
- C. Leave the suction and discharge ports open to prevent pressure buildup during water valve installation.
- D. Braze the capillary tube into the system.
- E. Connect the water supply line and turn on the water supply.
- F. Check for leaks in the water lines. If there are no leaks, turn off the water supply.
- G. Replace the filter drier. Refer to Section 5.8 for details.
- H. Evacuate and recharge system per instructions in Section 5.2.
- I. Turn on the water and check for leaks in the water lines with the refrigeration system running.
- J. Adjust the valve as necessary.

## 5.7 SOLENOID

Solenoid valves are installed on the liquid and suction lines of each freezing cylinder evaporator and on the liquid line of the hopper evaporators (Refer to Figure 5-11 and Figure 5-12). A solenoid valve has a magnetic coil that, when energized, lifts a plunger and allows refrigerant to flow. The solenoids are activated by the IntelliTec control and determine which evaporator receives refrigeration.

The suction line solenoid prevents refrigerant flow in the evaporator when the suction pressure drops due to the operation of the other evaporators in the system.

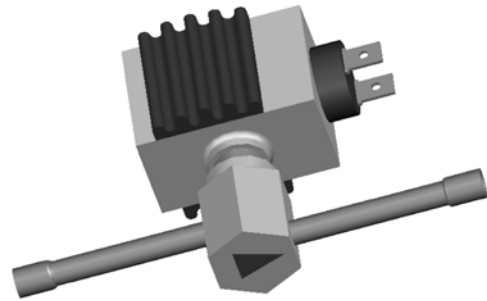

Figure 5-11 Liquid Line Solenoid Valve

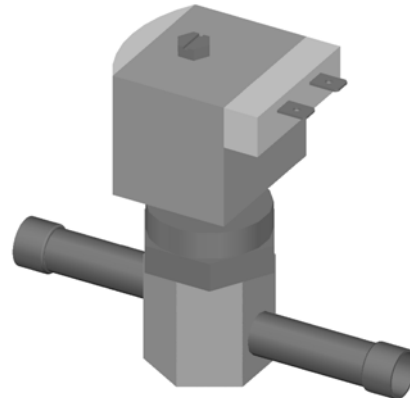

Figure 5-12 Suction Line Solenoid Valve

## ACTIVATING A SOLENOID

To open a solenoid, follow these steps:

- A. Turn the Main Power OFF/ON switch and both Freezing Cylinder OFF/ON switches to the OFF position.
- B. Locate the compressor contactor behind the right side panel and disconnect the two blue wires at terminal #82.
- C. Wrap electrical tape around disconnected terminal to insulate it.
- D. Remove belts from the pulleys to allow drive motors to spin freely.
- E. Connect power to the machine.
- F. Turn the Main Power OFF/ON switch and Freezing Cylinder OFF/ON switches to the ON position.
- G. Press the Push To Freeze button on both IntelliTec controls. This will energize the solenoid valves.

## SUCTION LINE SOLENOID TESTING

To check for leaking valve seats, follow the procedure outlined below. The liquid line solenoid must remain open for this test.

### NOTE

*Machine barrels must NOT contain frozen product for this test.*

- A. Turn the Main Power OFF/ON switch and both Freezing Cylinder OFF/ON switches to the OFF position.
- B. Attach a gauge to the Schrader valve located after the evaporator of the side being tested.
- C. Place the Main Power OFF/ON switch to the ON position.
- D. Place the opposite side Freezing Cylinder OFF/ON switch to the ON position.

### NOTE

*If checking the solenoid on the left side, place the right side Freezing Cylinder OFF/ON switch to the ON position. For the right side, place the left side switch to the ON position.*

- E. Start a freezing cycle of the opposite side by pressing the Push To Freeze button or by pulling the spigot handle.
- F. If the pressure drops more than 3 psi in 30 seconds on the side being tested, the suction line solenoid valve seat leaks and should be replaced. Repeat the procedure for the other side.

## LIQUID LINE SOLENOID TESTING

The following test will check if a liquid line solenoid has a leaking valve seat. The power to the solenoid is disconnected and refrigerant flow is monitored through the system. If the valve seat does not leak, the suction pressure during the test will read the same as the pressure when only the hopper refrigeration is running.

- A. Turn the Main Power OFF/ON switch and both Freezing Cylinder OFF/ON switches to the OFF position.
- B. Disconnect a terminal on each of the liquid line solenoids.
- C. Insulate the terminals with electrical tape.
- D. Attach gauges to the Schrader valves located after the evaporators on the suction line.
- E. Turn the Main Power OFF/ON switch and both Freezing Cylinder OFF/ON switches to the ON position.
- F. Start a freezing cycle by pressing the Push To Freeze button or by pulling on the spigot handles.
- G. The gauges should show approximately 14 psig after 1 minute.
- H. Watch the pressure in both freezing cylinders. The freezing cylinder with the greatest pressure rise

may have a leaking valve seat.

## SOLENOID MAGNETIC COIL REMOVAL

- A. Remove the side panel.
- B. Disconnect the electrical wires.
- C. Remove the retainer screw from the top of the solenoid and pull the magnetic coil off.

## SOLENOID MAGNETIC COIL INSTALLATION

To replace the magnetic coil, perform the following procedures:

- A. Connect the two electrical wires to the magnetic coil.
- B. Push the coil on to the solenoid valve stem.
- C. Make sure there isn't any foam insulation between the valve coil and valve body. Trim any excess insulation.
- D. Install retainer screw onto top of coil.

## SOLENOID VALVE REMOVAL

- A. Identify and disconnect the two wires from the solenoid coil.
- B. Remove the retainer holding the coil to the solenoid body and remove the coil.
- C. Recover refrigerant charge per instructions in Section 5.2.
- D. Remove insulation around valve and attached refrigeration lines.
- E. Apply heat sinks (wet cloth) to the insulated refrigerant lines near the valve.
- F. Leave a port open to prevent pressure buildup during solenoid removal.
- G. Unsweat the solenoid and remove.

## SOLENOID VALVE REPLACEMENT

To replace the solenoid, perform the following procedures:

- A. Position the new solenoid with the arrow pointing toward the direction of refrigerant flow.
- B. Apply a heat sink (wet cloth) to the solenoid valve.
- C. With the suction and discharge ports open, braze the solenoid into the system.
- D. Remove the heat sink from the valve.
- E. Replace insulation around valve.
- F. Replace the filter drier. Refer to Section 5.8 for details.
- G. Evacuate and recharge system per instructions in Section 5.2.

## 5.8 FILTER DRIER

The filter drier must be replaced every time the refrigeration system is opened for service. A new filter drier improves operation of the entire refrigeration system by stopping the circulation of moisture and by removing harmful contaminants (Refer to Figure 5-13).

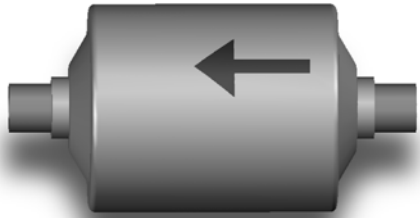

Figure 5-13 Filter Drier

### FILTER DRIER REMOVAL

- A. Recover refrigerant charge per instructions in Section 5.2.
- B. Cut the refrigeration line as close to the filter drier as possible and remove drier.
- C. Cap the ends of the drier using the plugs from the new drier.

#### NOTE

*The drier must be capped to prevent moisture from the environment*

### FILTER DRIER REPLACEMENT

- A. Position the filter drier so the arrow is pointing toward the direction of refrigerant flow (pointing away from the condenser).
- B. Apply a heat sink (wet cloth) to the filter drier.
- C. With the suction and discharge ports open, braze the filter drier into the system.
- D. Evacuate the system per instructions in Section 5.2.
- E. Recharge the system per instructions in Section 5.3.

## 5.9 CAPILLARY TUBE

The capillary tube meters refrigerant flow in the mix line evaporator (Refer to Figure 5-14). The amount of flow is dependent on the length and ID of the capillary tube as well as the refrigerant charge.

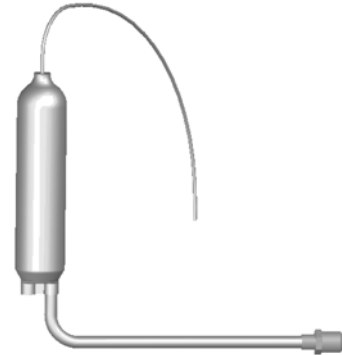

Figure 5-14 Capillary Tube and Drier Assembly

### CAPILLARY TUBE REMOVAL

#### NOTE

*The capillary tube assembly contains a drier. The entire assembly must be removed.*

- A. Recover refrigerant charge per instructions in Section 5.2.
- B. Leave a port open to prevent pressure buildup during capillary tube removal.
- C. Remove foam insulation from the capillary tube at the evaporator inlet.
- C. Unswear the capillary tube and remove.

### CAPILLARY TUBE REPLACEMENT

- A. Position the capillary tube in the refrigeration system.
- B. Apply a heat sink (wet cloth) to the capillary tube and drier assembly.
- C. With the suction and discharge ports open, braze the capillary tube into the system.
- D. Replace foam insulation to the capillary tube at the evaporator inlet.
- E. Evacuate the system per instructions in Section 5.2.
- F. Recharge the system per instructions in Section 5.3.

## SECTION 6 ELECTRICAL AND MECHANICAL CONTROL SYSTEMS

### NOTE

The wiring diagram is available in Section 8.

### 6.1 INTELLITEC CONTROLLER

Understanding the modes of operation and individual control settings will make servicing the control straightforward.

#### A. COMPONENTS OF CONTROLLER

The IntelliTec control consists of three main components; the control board (Figure 6-1), the membrane switch (Figure 6-2), and the display panel module (Figure 6-3). The membrane switch is connected to the display panel module via a 9-pin ribbon cable. The display panel module is connected to the IntelliTec control board through a telephone cord. The IntelliTec control board is connected to the machine through an 8-pin connector, a 7-pin connector, and a 6-pin connector.

The left side membrane switch (touchpad) controls the left freezing cylinder and the hopper; the right side membrane switch controls the right freezing cylinder. The IntelliTec control boards are mounted in the same respect; the left control board runs the left side and the right control board runs the right side.



Figure 6-1 IntelliTec Control Board



Figure 6-2 Membrane Switch

### 6.2 CONTACTORS

The compressor and drive motor contactors are mounted inside the electrical box behind the right side panel. There is one contactor for the compressor and a contactor for each drive motor.

The IntelliTec control sends electronic signals to trigger the contactors. Separate signals are used to control each drive motor contactor and the compressor contactor. The signals to the contactors are staggered, so the drive motor will always start three seconds before the compressor. By staggering the starting and stopping of the drive motor, maximum starting torque is available and voltage spikes are reduced.

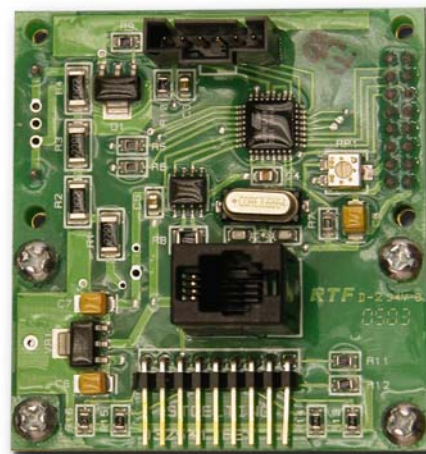

Figure 6-3 Display Panel Module

## A. CONTACTOR TESTS

The following tests will show if a contactor is working properly.

1. Open right side panel and visually check the IntelliTec control board.
2. Check for a signal going to contactor. When the spigot is opened or the Push To Freeze button is pressed, the DRV LED on the control board will light up. After three seconds, the CMP LED will light up (Refer to Figure 6-4). If the LEDs do not light up, refer to Section 7 Troubleshooting.

### NOTE

*In addition to the LEDs lighting, there will be an audible click from the contactors and the motor and compressor will start.*

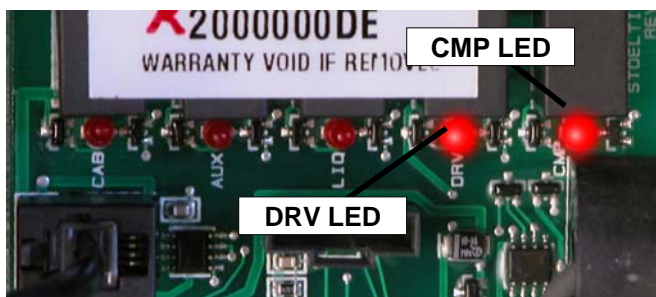

Figure 6-4 IntelliTec LEDs

3. Check to ensure contactor is receiving signal. Read voltage across the coils of the contactor during a freezing cycle. Voltage should be about 115V. If there is no voltage reading, refer to Section 7 Troubleshooting.

## 6.3 DRIVE MOTOR

The drive motors are designed specifically for the E131 and F131 machines. The drive motors are used to rotate the auger assemblies. An internal, normally closed, centrifugal switch starts the drive motor. The motors have an internal thermal overload.

### A. DRIVE MOTOR TEST

1. Make sure the Main Freezer Power and the Freezing Cylinder OFF/ON switches are in the OFF position.
2. Remove the back panel and a side panel.
3. Loosen the belt tension adjustment nut and remove the belt.
9. Start the drive motor.
10. Put a clamp ammeter on the motor wire at T1 of the motor contactor. The ammeter should read 2.1 amps  $\pm$ 0.5.

### NOTE

*The motor amps are based on 230VAC supply voltage.*

11. Place the Main Power OFF/ON and Freezing Cylinder OFF/ON switches in the OFF position.
12. Install the belt and tighten the tension bolt.
13. Use a Burroughs Belt Tension Gauge to set the tension for the drive belt. Set the belt tension to 35-40 lbs.
14. Using a straightedge, align the drive motor pulley with the gearbox pulley. Tighten the two allen head screws.

### B. DRIVE MOTOR REMOVAL

1. Disconnect machine from electrical supply before removing any panels for servicing.
2. Remove the back panel and the left side panel.
3. Remove the electrical cover plate from the back of the motor.
4. Identify (mark) wires and remove them from the motor.
5. Loosen the belt tension adjustment bolt and remove the belt. (Refer to Figure 6-5)

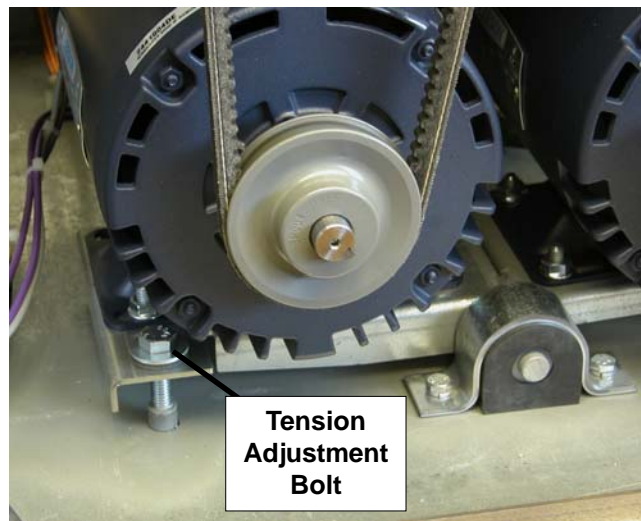

Figure 6-5 Removing Drive Motor

7. Remove the motor mounting bolts.
8. Loosen the two allen head screws from the pulley.
9. Remove the pulley and key from the motor shaft.

### C. DRIVE MOTOR INSTALLATION

1. Place the drive motor in position and install the four mounting bolts.
2. Place the pulley and key on the motor shaft.

### NOTE

*Do not tighten the pulley screws until after the belt tension has been properly adjusted.*

3. Install the belt and tighten the tension adjustment bolt.

4. Test for proper belt tension by pressing firmly on the belt. When the tension is properly adjusted, the belt should depress approximately 3/8" (roughly the width of the belt).
5. Using a straightedge, align the drive motor pulley with the gearbox pulley. Tighten the two allen head screws. (Refer to Figure 6-6)

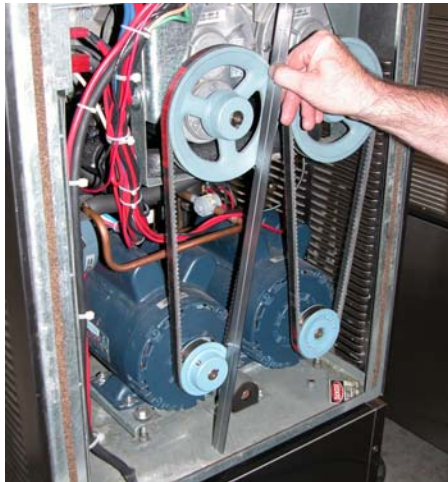

**Figure 6-6 Pulley Alignment**

6. Install wiring according to wiring diagram (located behind the left side panel). Install electrical cover plate.
7. Install back and side panels.

#### 6.4 CAPACITORS

The compressor start and run contactors are mounted behind the right side panel. They are accessed by removing the panel behind the condenser filter.

The start and run capacitors for the drive motors are mounted directly onto each motor body.

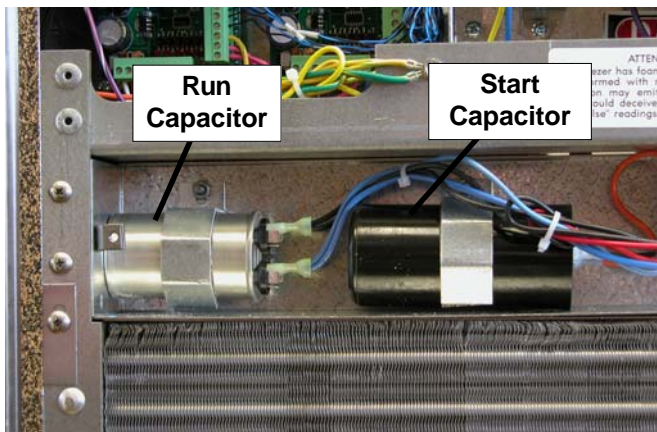

**Figure 6-7 Compressor Contactors**

#### A. CAPACITOR TEST

1. Disconnect machine from electrical supply before removing any panels for servicing.



#### WARNING

##### Hazardous voltage

The Main Freezer Power switch must be placed in the OFF position when disassembling for servicing. The machine must be disconnected from electrical supply before removing any access panel. Failure to disconnect power before servicing could result in death or serious injury.

2. Place the Main Power OFF/ON switch and both Freezing Cylinder OFF/ON switches in the OFF position.
3. Remove a lead from one of the capacitor terminals.
4. Using insulated pliers, discharge the capacitor by connecting a 20KΩ 5W resistor across the terminals.

#### NOTE

*Discharge the capacitor even if there is a bleeder resistor across the terminals. There may be an open in the bleeder resistor preventing it from working properly.*

5. Disconnect the bleeder resistor from the circuit.
6. Measure the capacitance across the terminals. The results should be as follows:

E131	Part	Rating	
		MFD	VAC
Drive Motor Start	<a href="#">231095</a>	500 MFD	125 VAC
Drive Motor Run	231096	50 MFD	240 VAC
Compressor Start	<a href="#">230632</a>	72-86 MFD	330 VAC
Compressor Run	230633	30 MFD	370 VAC

F131	Part	Rating	
		MFD	VAC
Drive Motor Start	<a href="#">231095</a>	500 MFD	125 VAC
Drive Motor Run	231096	50 MFD	240 VAC
Compressor Start	<a href="#">231079</a>	145-174 MFD	220 VAC
Compressor Run	<a href="#">231084</a>	30 MFD	370 VAC

## B. CAPACITOR REPLACEMENT

1. Disconnect machine from electrical supply before removing any panels for servicing.
2. Place the Main Power OFF/ON switch and both Freezing Cylinder OFF/ON switches in the OFF position.
3. Remove leads from the capacitor terminals.
4. Using insulated pliers, discharge the capacitor with a 20KΩ 5W resistor across the terminals.

### NOTE

*Discharge the capacitor even if there is a bleeder resistor across the terminals. There may be an open in the bleeder resistor preventing it from working properly.*

5. Pull the capacitor out of its holder and replace.
6. Connect the leads to the terminals of the new capacitor.

## 6.5 GEARBOX

### A. GEARBOX INSPECTION

Inspect the gearbox and listen for unusual noise. A grinding sound generally indicates a bad gear.

### B. GEARBOX REMOVAL

1. Disconnect machine from electrical supply before removing any panels for servicing.
2. Remove the back panel and the right side panel.
3. Remove the support brace from the gearbox shroud and from the tubing.
4. Remove the four nuts holding the support bracket and remove the bracket.
4. Remove the belts.
5. Remove the bolts holding the gearbox assembly and remove it.

### C. GEARBOX INSTALLATION

1. Place the gearbox in position from the rear of the machine. Fasten the bolts through the gearbox to the rear of the barrel.
2. Mount the pulley on the gearbox shaft and align with the motor pulley, then tighten the allen head screws.
3. Install the belt.
4. Press firmly on the belt.
5. When the tension is properly adjusted, the belt will depress the approximate width of the belt with the pressure of a finger.
6. If an adjustment is necessary, loosen the four motor plate retaining nuts, adjust belt tension then retighten the four nuts.
7. Install the support bracket and support brace to the gearbox.

## 6.6 CONDENSER FAN MOTOR (AIR-COOLED ONLY)

### A. FAN MOTOR REPLACEMENT

1. Disconnect machine from electrical supply before removing any panels for servicing.
2. Remove the right side panel and the rear panel.
3. Trace and disconnect the black and white wires from the fan motor to the T1 and T2 terminals on the compressor contactor.
4. Loosen set screw on fan blade.
5. Remove the three bolts from the fan motor mounting plate and remove the motor.

### B. FAN MOTOR INSTALLATION

1. Attach motor to the mounting plate with the three bolts.
2. Place fan blade on motor shaft. Make sure the motor shaft does not extend past the hub of the fan blade. Tighten the set screw.

### NOTE

*The fan blades must be at least 3/8" from the fins on the condenser.*

3. Ensure purple wire is terminated.
4. Ensure red wire is terminated with blue wire.
5. Route the white and black wires through the side panel to the compressor contactor.
6. Connect black wire to the T1 terminal.
7. Connect white wire to the T2 terminal.

## 6.7 SPIGOT SWITCH

The spigot switch is a normally closed, held open switch. When a spigot is pulled, the spigot switch sends a signal to the IntelliTec control to start the auger drive and refrigeration system. This signal moves the control to "Serve Mode", or if it already is in "Serve Mode", it resets the cycle count. After serving product, the IntelliTec continues a freezing cycle until the product reaches consistency.

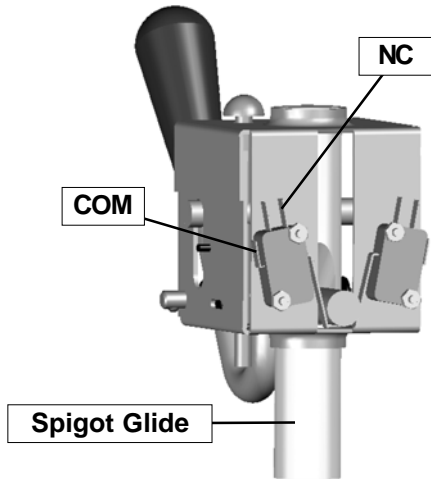

Figure 6-8 Spigot Cam Assembly (Center Spigot)

### SPIGOT SWITCH TEST - ADJUSTMENT

#### NOTE

*Adjustments to the spigot switch should be done after the product is at consistency in "Serve Mode" or when the machine is empty.*

1. Open the spigot slowly and listen for a click when the spigot switch closes.
2. The clicking sound should be within the first 1/2" of the spigot glide movement (Refer to Figure 6-8). If the switch does not close, an adjustment may be necessary.

#### NOTE

*The center spigot has two switches; one for each side. When testing the center spigot, there should be two audible clicks occurring almost simultaneously.*

## SPIGOT SWITCH TESTING - ELECTRICAL

1. Disconnect the switch from the circuit by unplugging the connectors.



### WARNING

#### Hazardous voltage

The Main Freezer Power switch must be placed in the OFF position when disassembling for servicing. The machine must be disconnected from electrical supply before removing any access panel. Failure to disconnect power before servicing could result in death or serious injury.

2. Check resistance readings across the common (COM) and normally closed (NC) terminals. When the spigot is closed, the resistance should show an open. When the spigot is opened, the switch will close and the resistance should be 0 ohms.

### SPIGOT SWITCH ADJUSTMENT

1. Place the Main Power OFF/ON switch and both Freezing Cylinder OFF/ON switches in the OFF position.
2. Remove the header panel.
3. Loosen the bolts on the spigot switch.
4. Using a pencil, mark the spigot glide 1/4" from the spigot housing.
5. Adjust the switch to activate when the plastic glide reaches the mark.
6. Fully tighten the retaining bolts and remove mark from spigot glide.

### SPIGOT SWITCH REPLACEMENT

1. Remove the header panel.
2. Remove the dispense rate adjuster knob located below the header panel. (Refer to Figure 6-9)

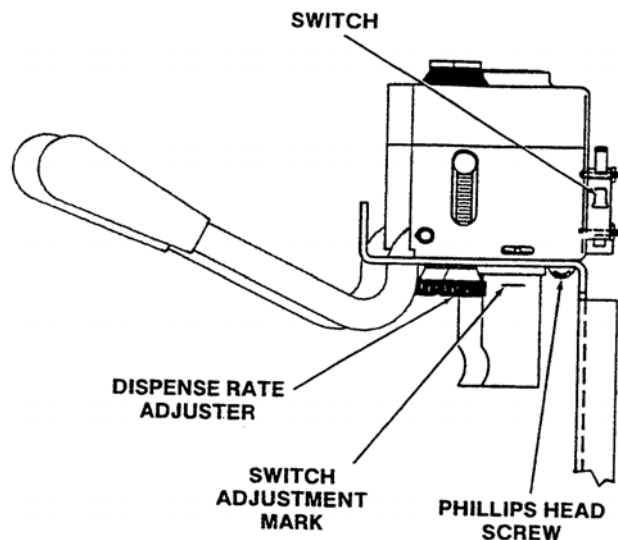

Figure 6-9 Spigot Switch Replacement

3. Remove the two Phillips head screws that attach the spigot cam assembly to the panel. Remove the assembly.
4. Disconnect the connector from the switch and remove the switch..
5. Install the replacement switch onto the handle assembly. Do not fully tighten the retaining screws at this time.
6. Using a pencil, mark the spigot glide 1/4" from the spigot housing. Adjust the switch to activate when the spigot handle moves the glide to the mark.
7. Fully tighten the retaining screws.
8. Attach the connector to the spigot switch.
9. Position the spigot handle assembly in the electrical box and fasten securely with the two Phillips head screws.
10. Replace the dispense rate adjuster knob and tighten.
11. Replace the header panel and secure with the two Phillips head screws.

## 6.8 TEMPERATURE CONTROL SENSOR

The temperature control sensor is a thermistor used to sense the temperature of the suction line. As the suction line temperature increases, the internal resistance of the thermistor will decrease. Refer to Figure 6-10 for the relationship between sensor resistance and temperature. The IntelliTec control board monitors this value. In "Serve Mode", when the temperature of the sensor equals the Cut In T value on the control, a freezing cycle will start.

When troubleshooting a sensor, refer to the wiring diagram and remove the wires from the control board. Measure the resistance of the sensor and compare it with the table below. If the resistance is not within this range, replace it.

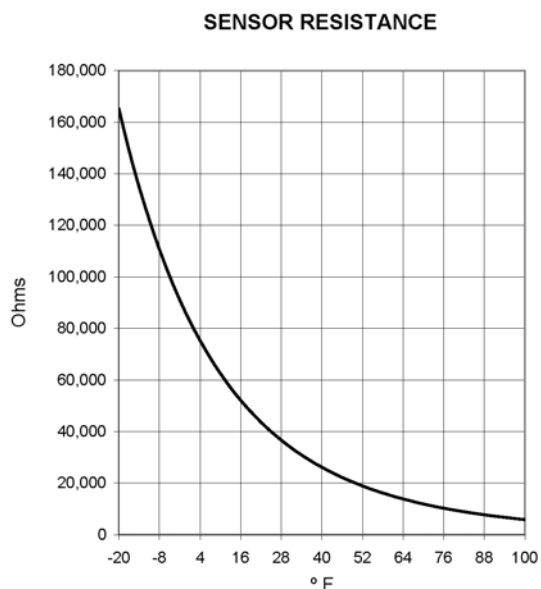

**Figure 6-10 Resistance Related to Temperature**

# SECTION 7 TROUBLESHOOTING

## 7.1 ERROR CODES

When the machine experiences a problem, one of the following error codes will be displayed on the control panel. Each error code directs you to the system location of the malfunction.

ERROR CODE	MALFUNCTION
1	Soft
2	High Torque
3	Run Time
4	Clean
5	Freezing Cylinder Sensor
6	Hopper Sensor (single hopper machines)
7	Drive Motor
8	Cab Sensor
9	High Pressure Cutout
10	Auxiliary Sensor
11	Low Temperature
12	Left Hopper Sensor
13	Right Hopper Sensor

To return the machine to normal operation, any error causing condition must be corrected and the Freezing Cylinder Off-On switch must be placed in the Off position and back in the On position before the affected side of the machine will return to normal operation.

## 7.2 TROUBLESHOOTING

### Error Code 1 - Soft Error

The Soft Error (E1) is an internal control board error that is logged for future analysis. The refrigeration is never stopped and the machine will continue to operate normally.

### Error Code 2 - High Torque

If the control panel displays a High Torque Error (E2), the controller has sensed that the drive motor is running at 125% of the preset CutOut amp setting for 10 or more seconds. Very low and/or fluctuating supply voltages typically cause this error. The error can also be caused by faulty motor or starting components which could produce a high amp draw.

### Error Code 3 - Run Time

The Run Time Error (E3) occurs when the compressor runs continuously for 20 minutes without the product reaching consistency in "Serve Mode" or if the product does not reach proper temperature in "Sleep 2 Mode". This error is generally caused by very low mix levels in the hopper or from product breakdown. Another common cause results

from a restriction preventing mix from entering the freezing cylinder. Check the mix in the hopper. If the level mix is low, add mix. If there is a possibility that the mix is broken down, clean and sanitize the machine and replace the mix with fresh product.

Ice crystals in the hopper can clog the mix inlet regulator and prevent mix from entering the freezing cylinder. Thoroughly thaw mix per manufacturer's recommendations. To check for ice crystals, pour a small amount of product in the mix container through a clean and sanitized sieve or strainer. If ice crystals are in the mix, check the temperature where the mix is stored. If the hopper temperature is below 34°F (1°C), adjust the temperature from the left control touchpad, under the Storage Menu (Refer to Section 4.7).

The Run Time Error may also occur if airflow within the machine has reduced or stopped. Check the sides and top of the machine for anything that would restrict airflow. Check the condenser filter and clean if necessary. Check the evaporator for frost that could restrict airflow.

The compressor will run continuously if a solenoid valve fails to open. This could be due to loose wiring, magnetic coil failure, a stuck valve or a faulty control board.

After the cause of the problem is found and remedied place the Freezing Cylinder Off-On switch in the Off position and back in the On position.

### Error Code 4 - Clean

If the machine is left in the Clean Mode for more than 20 minutes, the control panel will display a Clean Error (E4). This condition does not reflect a problem with the machine itself. The Clean Error has been programmed into the controller as a safeguard to protect the machine from potential damage caused by the machine being accidentally left in "Clean Mode". The control will attempt to restart itself after 5 minutes. The display will then flash and read Restart. To clear the Clean Error, turn the Freezing Cylinder Off-On switch Off and back On. After restarting the machine, a refrigeration cycle will begin. This protects the product in case the clean button was pressed by mistake.

## Error Code 5 - Freezing Cylinder Sensor

The Freezing Cylinder Sensor Error (E5) indicates a failure of the barrel sensor or an extreme out of range condition ( $< -34^{\circ}\text{F}$  or  $> 99^{\circ}\text{F}$ ). If the control panel displays an E5, place the Freezing Cylinder Off-On switch Off and back On. If the control panel still displays the error code, refer to the machine's wiring diagram and the Temperature Sensor Chart (Figure 7-1). Check each lead of the sensor to ground for continuity. If continuity is found, replace the sensor. To check the resistance of the sensor, place a thermocouple on the suction line at the exit of the freezing cylinder. Compare temperature and sensor resistance with the table as reference. If measured value does not coincide with a value on the table ( $\pm 400$  ohms), replace the sensor.

### NOTE

*When the machine encounters a Freezing Cylinder Sensor Error, the machine will continue to run using preset timers. This mode will allow the operator to continue serving product until the machine can be serviced.*

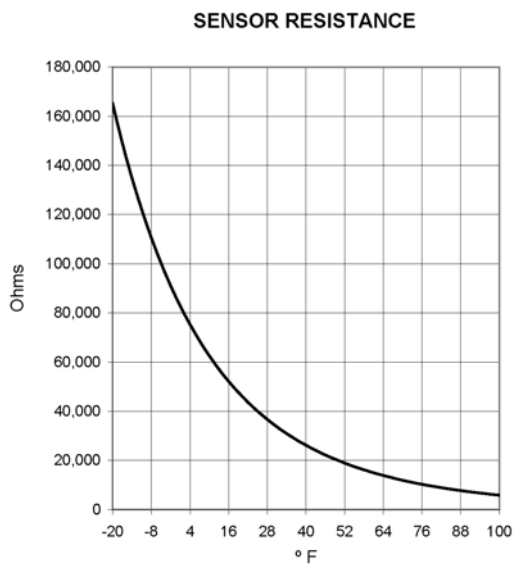

**Figure 7-1 Temperature Sensor Resistance**

## Error Code 6 - Hopper Sensor (single hopper machines)

The Hopper Sensor Error (E6) will not occur on the machine.

## Error Code 7 - Drive Motor

If the control panel displays a Drive Motor Error (E7), the control does not sense current coming from the drive motor. Turn the Freezing Cylinder Off-On switch Off and back On. If the error returns, use the machine's wiring diagram and check connections at the IntelliTec control and at the motor. An E7 may also be the result of a faulty drive motor contactor.

## Error Code 8 - Cab Sensor

A Cab Sensor Error (E8) will not occur on the machine.

## Error Code 9 - High Pressure Cutout

High Pressure Cutout Errors (E9) are usually caused by a dirty or inefficient condenser. If the control panel displays an E9, place the Freezing Cylinder Off-On switch in the Off position. Press the High Pressure Cutout Reset switch (water-cooled only) and place the Freezing Cylinder Off-On switch back in the On position.

In air cooled condenser models, check the air filter to make sure it is clean. Replace or clean the filter as required. Check for proper air clearance around the machine. Refer to the Section 2 - Installation Instructions for clearances. Check the condenser for blockage, and be sure condenser fan is functioning.

On water cooled condenser models, check for proper water flow through the condenser coil.

After the cause of the error is determined and corrected, turn the Freezing Cylinder Off-On switch Off and back On.

## Error Code 10 - Auxiliary Sensor

An Auxiliary Temperature Sensor Error (R10) occurs if the temperature sensor on the control board fails. Turn the Freezing Cylinder Off-On switch Off and back On.

## Error Code 11 - Low Temperature

The Low Temperature Error (E11) occurs when the temperature of the gas refrigerant at the barrel sensor falls below  $-20^{\circ}\text{F}$ . Although the machine will not shut down, the active freezing cycle will immediately end. This error usually occurs when the machine continues to run in a low mix condition or if the machine runs out of mix. The product towards the front of the barrel tends to freeze solid.

## Error Code 12 - Left Hopper Sensor

The Left Hopper Sensor Error (E12) indicates a failure of the hopper sensor or an extreme out of range condition ( $< -34^{\circ}\text{F}$  or  $> 99^{\circ}\text{F}$ ). If the control panel displays an E12, turn the left Freezing Cylinder Off-On switch Off and back On. If the control panel still displays the error condition code, refer to the machine's wiring diagram and the Temperature Sensor Chart (Figure 7-1). Check each lead of the sensor to ground for continuity. If continuity is found, replace the sensor. To check

the resistance of the sensor, place a thermocouple on the suction line at the exit of the freezing cylinder. Compare temperature and sensor resistance with the table as reference. If measured value does not coincide with a value on the table ( $\pm 400$  ohms), replace the sensor.

**NOTE:**

*If the right control panel shows an E12, make sure the storage setting is set to NONE.*

**Error Code 13 - Right Hopper Sensor**

The Right Hopper Sensor Error (E13) indicates a failure of the hopper sensor or an extreme out of range condition ( $< -34^{\circ}\text{F}$  or  $> 99^{\circ}\text{F}$ ). If the control panel displays an E13, turn the right Freezing Cylinder Off-On switch Off and back On. If the control panel still displays the error condition code, refer to the machine's wiring diagram and the Temperature Sensor Chart (Figure 11). Check each lead of the sensor to ground for continuity. If continuity is found, replace the sensor. To check the resistance of the sensor, place a thermocouple on the suction line at the exit of the freezing cylinder. Compare temperature and sensor resistance with the table as reference. If measured value does not coincide with a value on the table ( $\pm 400$  ohms), replace the sensor.

**NOTE:**

*If the right control panel shows an E13, make sure the storage setting is set to NONE.*

**COMMOTIMEOUT Error**

A COMMOTIMEOUT Error indicates a communication interruption between the display and the control board. This error can be caused by a poor connection or a faulty phone cable. Disconnect and reconnect the telephone cable at the control board. If the error does not clear, disconnect and reconnect the telephone cable at the display panel module. If the error still appears, the cable may be faulty or the display panel module may be faulty.

**Alternating Flashing Control Panel Lights**

On machines with a Main Power Switch, when this switch is placed in the ON position and the Freezing Cylinder OFF/ON switch is in the OFF position, the green and amber display panel lights will flash in alternating sequence. This indicates that the storage cabinet or hopper is being refrigerated, but the left freezing cylinder is not receiving power. Placing the Freezing Cylinder OFF/ON switch in the ON position will return the freezing cylinder to the SLEEP mode. Pressing the PUSH TO FREEZE button will begin the freezing cycle.

The display panel lights will also flash in an alternating sequence under any error codes. Clear the error and place the Freezing Cylinder Off-On switch in the Off position and back in the On position.

**7.3 SERVICING TIP**

**Prevent Compressor from Running During Servicing**

When servicing the machine, set the Refriger setting on the left IntelliTec control from 2 Hopper to None (Refer to Section 3.3). This will prevent the compressor from running. When service work has been completed, change the Refriger setting back to its previous value.

## 7.4 TROUBLESHOOTING - MACHINE

PROBLEM	POSSIBLE CAUSE	REMEDY
<b>Machine does not run.</b>	<ol style="list-style-type: none"> <li>1. Power to machine is off.</li> <li>2. Blown fuse or tripped circuit.</li> <li>3. Freeze-up (auger will not turn).</li> <li>4. High pressure cut-out tripped.</li> <li>5. Front door not in place.</li> </ol>	<ol style="list-style-type: none"> <li>1. Supply power to machine.</li> <li>2. Replace or reset.</li> <li>3. Turn CLEAN-OFF-ON switch to OFF (middle) position for 15 minutes, then restart.</li> <li>4. Wait until automatic reset for machine to start.</li> <li>5. Assemble front door in place.</li> </ol>
<b>Machine will not shut off.</b>	<ol style="list-style-type: none"> <li>1. Drive belt failure.</li> <li>2. Consistency temperature setting is too firm.</li> <li>3. Refrigeration problem.</li> </ol>	<ol style="list-style-type: none"> <li>1. Replace drive belt.</li> <li>2. Turn Consistency Adjustment knob counter-clockwise.</li> <li>3. Check system. (See Section 5)</li> </ol>
<b>Product is too firm.</b>	<ol style="list-style-type: none"> <li>1. CutOut setting is too high.</li> <li>2. Product break down.</li> </ol>	<ol style="list-style-type: none"> <li>1. Adjust the CutOut amps (See Section 3-10).</li> <li>2. Drain, clean and sanitize machine. Fill with fresh mix.</li> </ol>
<b>Product is too soft.</b>	<ol style="list-style-type: none"> <li>1. No vent space for free flow of cooling air.</li> <li>2. Air temperature entering condenser is above 100°F.</li> <li>3. Condenser is dirty.</li> <li>4. CutOut setting is too low.</li> <li>5. Stabilizers in mix are broken down.</li> <li>6. Auger is assembled incorrectly.</li> <li>7. Refrigeration problem.</li> </ol>	<ol style="list-style-type: none"> <li>1. A minimum of 3" of vent space required. (See Section 2)</li> <li>2. Change location or direct hot air away from machine.</li> <li>3. Clean. (See Section 3)</li> <li>4. Adjust the CutOut amps (See Section 3-10).</li> <li>5. Remove mix, clean, sanitize and freeze down with fresh mix.</li> <li>6. Remove mix, clean, reassemble, sanitize and freeze down.</li> <li>7. Check system. (See Section 5)</li> </ol>
<b>Product does not dispense.</b>	<ol style="list-style-type: none"> <li>1. No mix in hopper.</li> <li>2. Capacity of machine is being exceeded.</li> <li>3. Drive motor overload tripped.</li> <li>4. Drive belt failure.</li> <li>5. Freeze-up (Auger will not turn).</li> </ol>	<ol style="list-style-type: none"> <li>1. Fill hopper with mix.</li> <li>2. Slow up on the draw rate.</li> <li>3. Wait for automatic reset. (If condition continues, call distributor for service.)</li> <li>4. Replace drive belt.</li> <li>5. Turn CLEAN-OFF-ON switch to OFF (middle) position for 15 minutes, then restart.</li> </ol>
<b>Drive belt slipping or squealing.</b>	<ol style="list-style-type: none"> <li>1. Worn drive belt.</li> <li>2. Freeze-up (Auger will not turn).</li> <li>3. Not tensioned properly</li> </ol>	<ol style="list-style-type: none"> <li>1. Replace drive belt.</li> <li>2. Turn CLEAN-OFF-ON switch to OFF (middle) position for 15 minutes, then restart.</li> <li>3. Adjust belt tension</li> </ol>
<b>Rear auger seal leaks.</b>	<ol style="list-style-type: none"> <li>1. Outside surface of rear auger seal is lubricated.</li> <li>2. Rear seal missing or damaged.</li> <li>3. Seal o-ring missing, damaged or installed incorrectly.</li> <li>4. Worn or scratched auger shaft.</li> </ol>	<ol style="list-style-type: none"> <li>1. Clean lubricant from outside of rear seal, lubricate inside of seal and reinstall.</li> <li>2. Check or replace.</li> <li>3. Check. or replace.</li> <li>4. Replace auger shaft.</li> </ol>
<b>Front door leaks.</b>	<ol style="list-style-type: none"> <li>1. Front door knobs are loose.</li> <li>2. Spigot parts are not lubricated.</li> <li>3. Chipped or worn spigot o-rings.</li> <li>4. O-rings or spigot installed wrong.</li> <li>5. Inner spigot hole in front door nicked or scratched.</li> </ol>	<ol style="list-style-type: none"> <li>1. Tighten knobs.</li> <li>2. See Section 3.</li> <li>3. Replace o-rings.</li> <li>4. Remove spigot and check o-ring.</li> <li>5. Replace front door.</li> </ol>

## SECTION 8 REPLACEMENT PARTS

### 8.1 DECALS AND LUBRICATION

Part	Description	Quantity
208135	Brush - 4" X 8" X 16" (Barrel)	1
208380	Brush - 1/4" X 3" X 14"	1
208401	Brush - 1" X 3" X 10"	1
208467	Brush - 3/8" X 1" X 5"	1
236025	Card - Cleaning Instruction	1
324065	Decal - Water Inlet	1
324105	Decal - Caution Electrical Shock	1
324106	Decal - Caution Electrical Wiring Materials	1
324107	Decal - Caution Hazardous Moving Parts	1
324141	Decal - Caution Rotating Blades	1
324200	Decal - High Pressure Cut-Out (Water-Cooled)	1
324208	Decal - Attention Refrigerant Leak Check	1
324393	Decal - Stoelting Swirl Logo (Drip Tray Support)	1
324509	Decal - Cleaning Instructions	1
324566	Decal - Wired According To	1
324584	Decal - Adequate Ventilation 3"	1
324592	Decal - Hold Ready	1
324593	Decal - Power	1
324594	Decal - Attention Heat Sensitive	1
324612	Decal - Control	1
324686	Decal - Danger Automatic Start	1
324803	Decal - Domed Stoelting Logo (Large) (Header Panel)	1
324804	Decal - Domed Stoelting Swirl (Header Panel)	1
324806	Decal - Domed A & W Logo (Header Panel)	1
324825	Decal - Main Freezer Power	1
324827	Decal - Freezing Cylinder	1
324889	Decal - Orange Tree	1
368140	Filter - Air (Condenser)	1
396241	Gasket - Freezer Base	1
508048	Lubricant - Spline (2 oz Squeeze Tube)	1
508135	Petrol Gel - 4 oz Tube	1
513647	Manual - Owner's	-
1159584	Mix Out Audible Signal	-
2177917	Brush Kit	-

## 8.2 AUGER SHAFT AND FACEPLATE PARTS

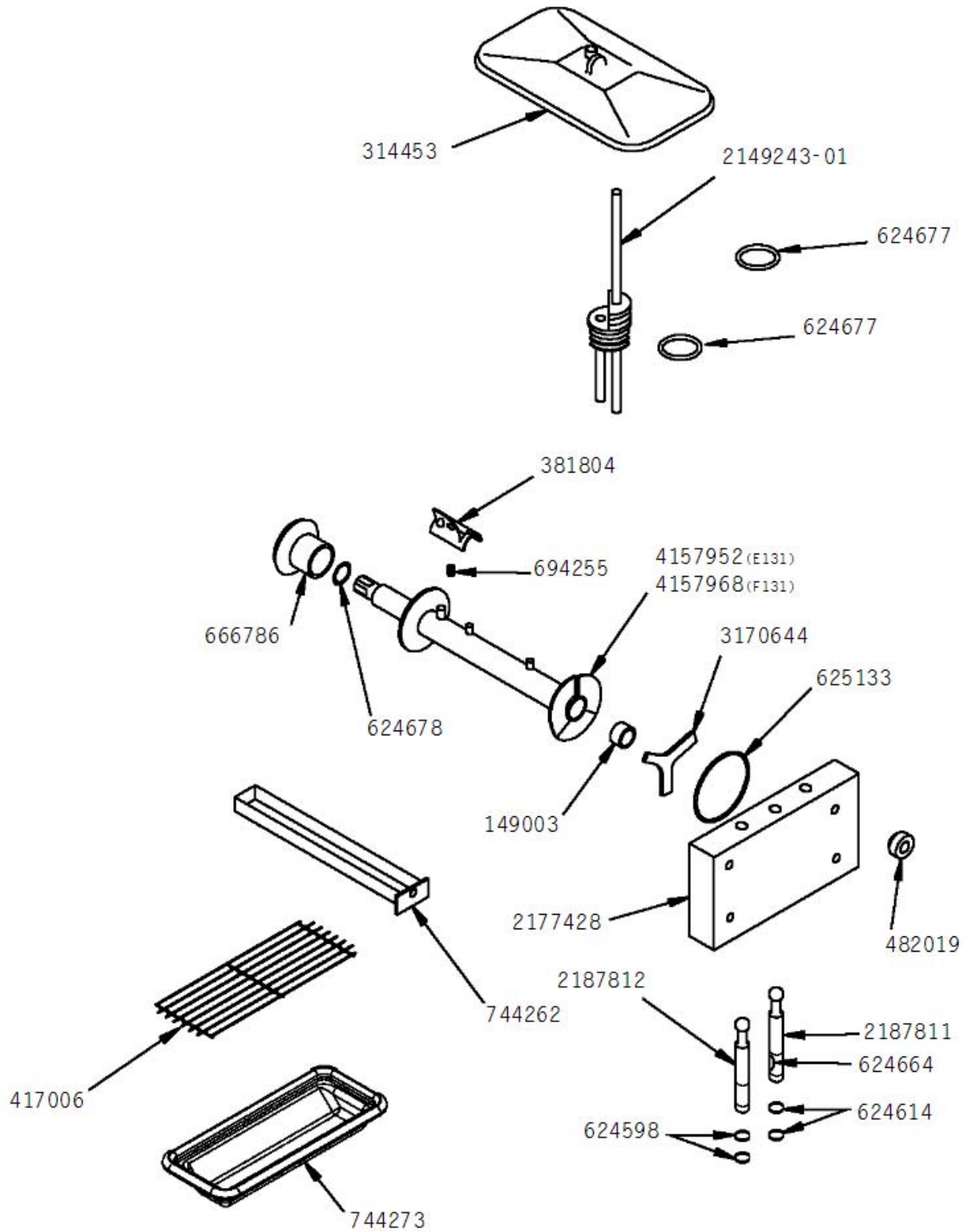

## 8.2 AUGER SHAFT AND FACEPLATE PARTS (CONTINUED)

Part	Description	Quantity
149003	Bushing - Front Auger Support	2
232734	Cap - Rosette - Teardrop	3
266076	Clip - Drip Tray	2
314453	Cover - Hopper	2
381804	Auger Flight	6 (E131) 8 (F131)
417006	Grid - Drip Tray (Metal)	1
482019	Knob - Front Door (Black)	4
624598-5	O-Ring - Outside Spigot - Black (5 Pack)	4
624614-5	O-Ring - Top & Bottom Center Spigot - Black (5 Pack)	2
624664-5	O-Ring - Middle Center Spigot - Black (5 Pack)	1
624677-5	O-Ring - Mix Inlet - Black (5 Pack) (Spigot Extension - Ser. #5687 Plus)	4
624678-5	O-Ring - Rear Seal - Black (5 Pack)	2
625133	O-Ring - Front Door - Red	2
666786	Seal - Rear Auger - Black	2
694255	Spring - Auger Flight	6 (E131) 8 (F131)
744260-SV	Tray - Drip	1
744273	Tray - Drain (Black Plastic)	1
1159501	O-Ring & Bushing Kit	-
1177429	O-Ring & Spigot Extension Kit	-
2149243-01	Mix Inlet Assembly - 3/16" Hole - Standard Length (2A)	2
2177072	Extension - Spigot - 1.5"	-
2177073	Extension - Spigot - 2.5"	-
2177074	Extension - Spigot - 3.2"	-
2177428	Door w/Pins (Requires #1177429)	1
2187811	Spigot Body - Center	1
2187812	Spigot Body - Outer	2
3170644	Support - Front Auger	2
4157952	Auger Shaft	2 (E131)
4157968	Auger Shaft	2 (F131)

### 8.3 FRONT

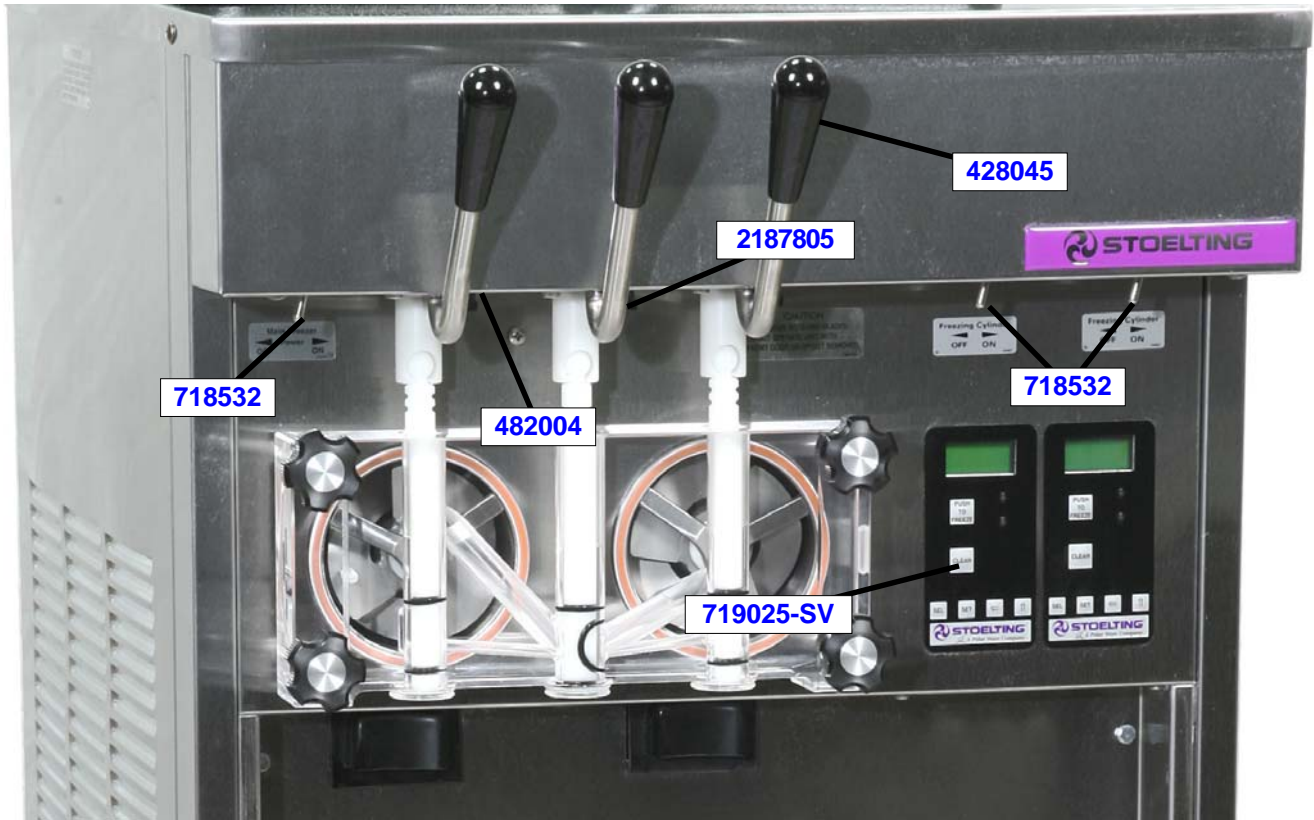

Part	Description	Quantity
215061	Plug - Bumber (Drip Tray)	2
428045	Knob - Spigot Handle (Black)	3
482004	Knob (Spigot Adjustment)	3
718532	Switch - Toggle (Freezing Cylinder & Main Power On-Off)	3
719025-SV	Switch - Membrane Strip	2
1158090-SV	Switch - Door Interlock	1
2183006	Level Probe Assembly - Hopper	2
2187805	Handle - Spigot (Metal Only)	3
3158185	Handle - Lifting (Metal)	1

### 8.4 PANELS

Part	Description	Quantity
232091	Cap - Protective (Gray) - #490716 Leg	4
490716	Leg	4
647653	Screw - Panel	-
2187906-SV	Panel - Front	1
3157964-SV	Panel - Side w/Insulation	2
3159551-SV	Panel - Rear w/Insulation (Water-Cooled)	1
3183224-SV	Panel - Rear w/Insulation (Air-Cooled)	1
3183225-SV	Panel - Rear w/Insulation (Water-Cooled)	1

## 8.5 LEFT SIDE

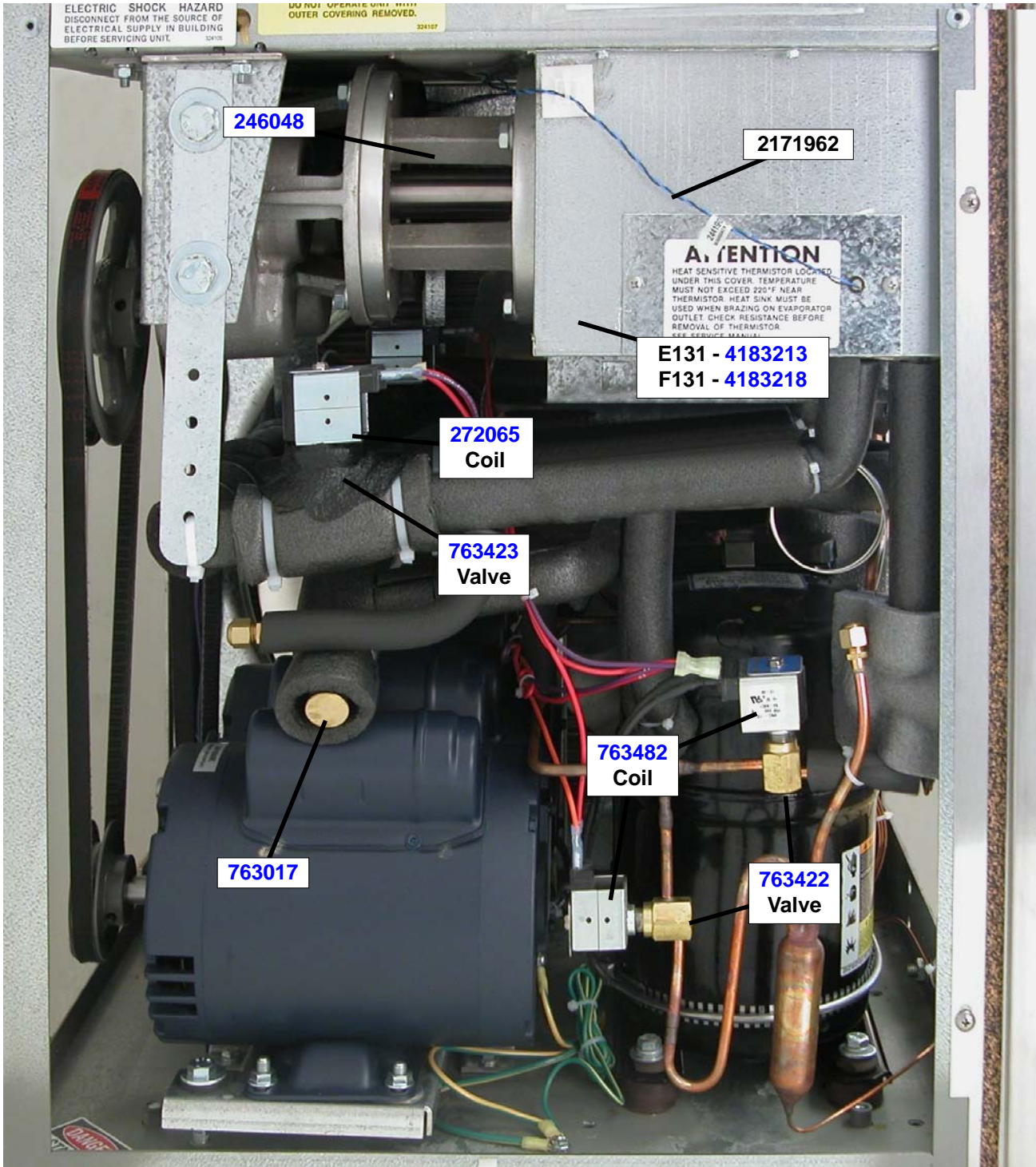

Part	Description	Quantity
246048	Spacer - Speed Reducer	2 (E131)
272065	Valve Coil - Solenoid (#763723 Valve)	2
458003	Indicator - Liquid Line	1
763017	Valve - Hot Gas Bypass	1
763422	Valve - Solenoid (Liquid Line)	3
763423	Valve - Solenoid (Suction Side)	2
763482	Valve Coil - Solenoid (#763422)	3
2171962	Sensor Probe Kit	1
4183213	Evaporator Assembly	2 (F131)
4183218	Evaporator Assembly	2 (E131)

8.6 RIGHT SIDE

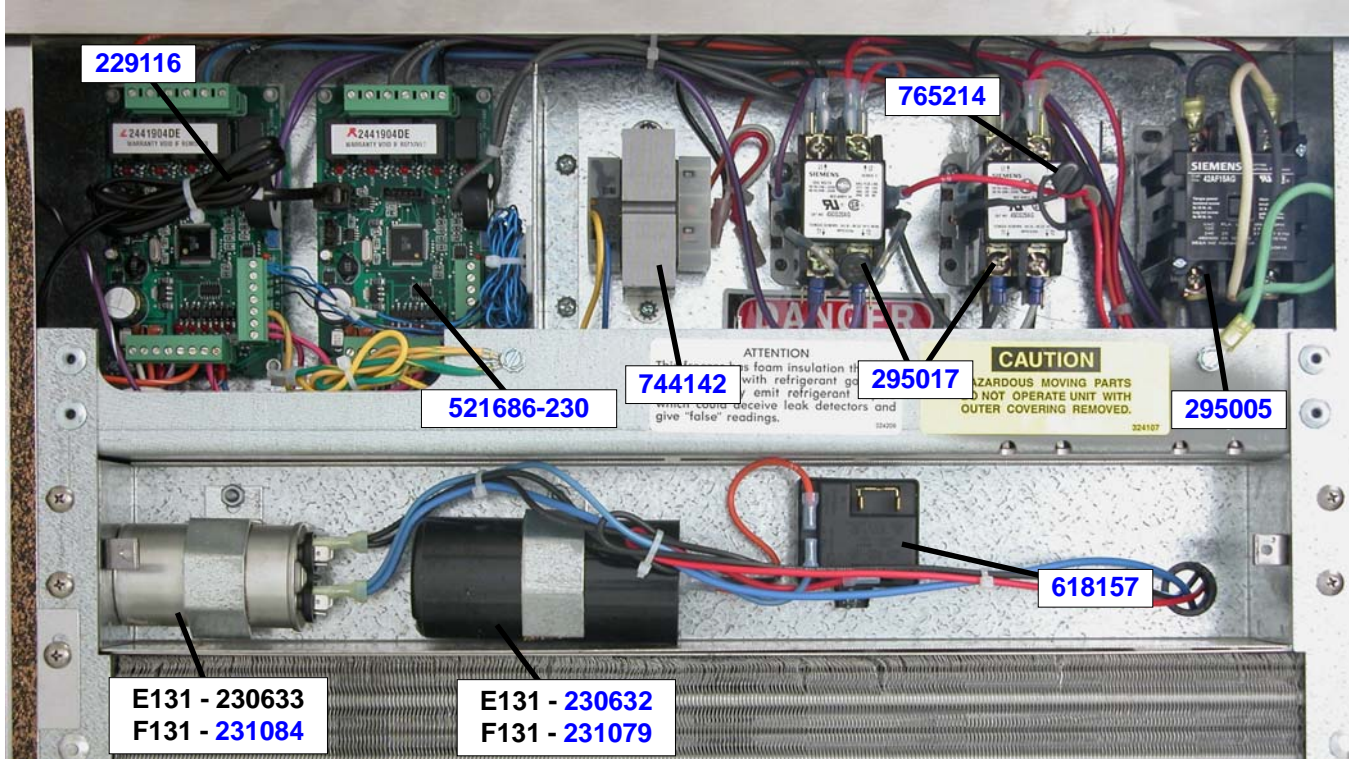

8.7 FRONT

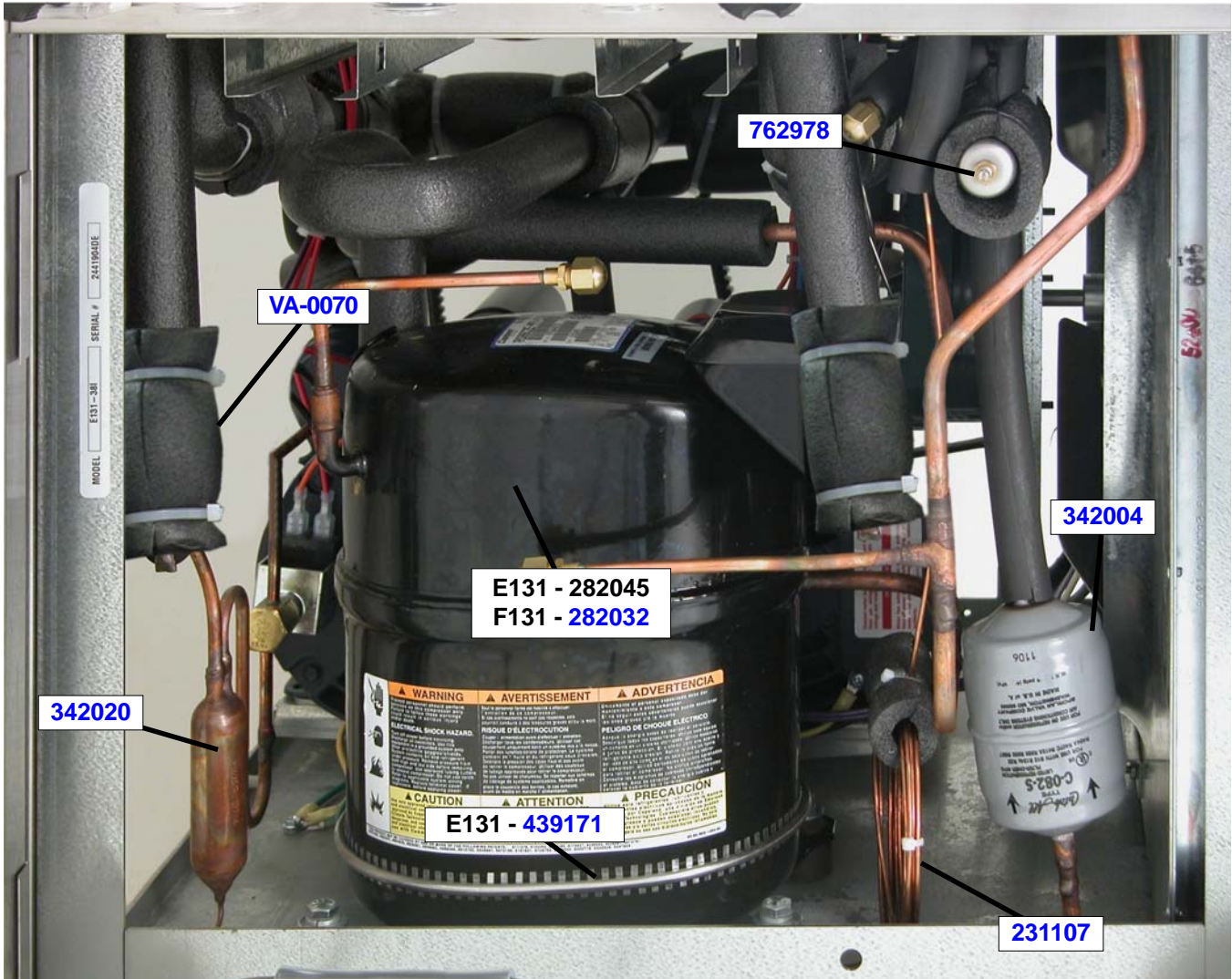

## 8.6 RIGHT SIDE (CONTINUED)

Part	Description	Quantity
229116	Cable - Phone (Control Board To Display Board)	2
230632	Capacitor - Start (#282045 Compressor)	1 (E131)
230633	Capacitor - Run (#282045 & #282050 Compressors)	1
230649	Capacitor - Start (#282050 Compressor)	1 (F131)
231027	Capacitor - Run (#282052 Compressor)	1 (E131)
231042	Capacitor - Start (#282052 Compressor)	1 (E131)
231079	Capacitor - Start (#282032 Compressor)	1 (F131)
231084	Capacitor - Run (#282032 Compressor)	1 (F131)
295005	Contactactor - Compressor (42AF15AG)	1
295017	Contactactor - Drive (45CG20AG)	1
332541	Board - Display Module	2
439171	Heater - Crankcase (#282045 Compressor)	1 (E131)
521686-230	Program Board - IntelliTec (208V / 230V)	2
618157	Relay - Start (R404A Compressor)	1
618142	Relay - Start (#282050 & #282052 Compressors)	1
744142	Transformer	1
765214	Varistor Harness	6

## 8.7 FRONT (CONTINUED)

Part	Description	Quantity
231107	Cap Tube	1
282032	Compressor - Copeland 1 PH - 60 Hz (No Capacitors)	1 (F131)
282045	Compressor - Copeland 1 PH - 60 Hz (No Capacitors)	1 (E131)
282050	Compressor - 1 PH (50 Hz) (R404A)	1 (F131)
282052	Compressor - 50 Hz (No Capacitors) (R404A)	1 (E131)
342004	Drier (Main)	1
342020	Drier (Hopper)	1
762978	Valve - EPR	1
VA-0070	Valve - Expansion (AXV)	2

## 8.8 REAR

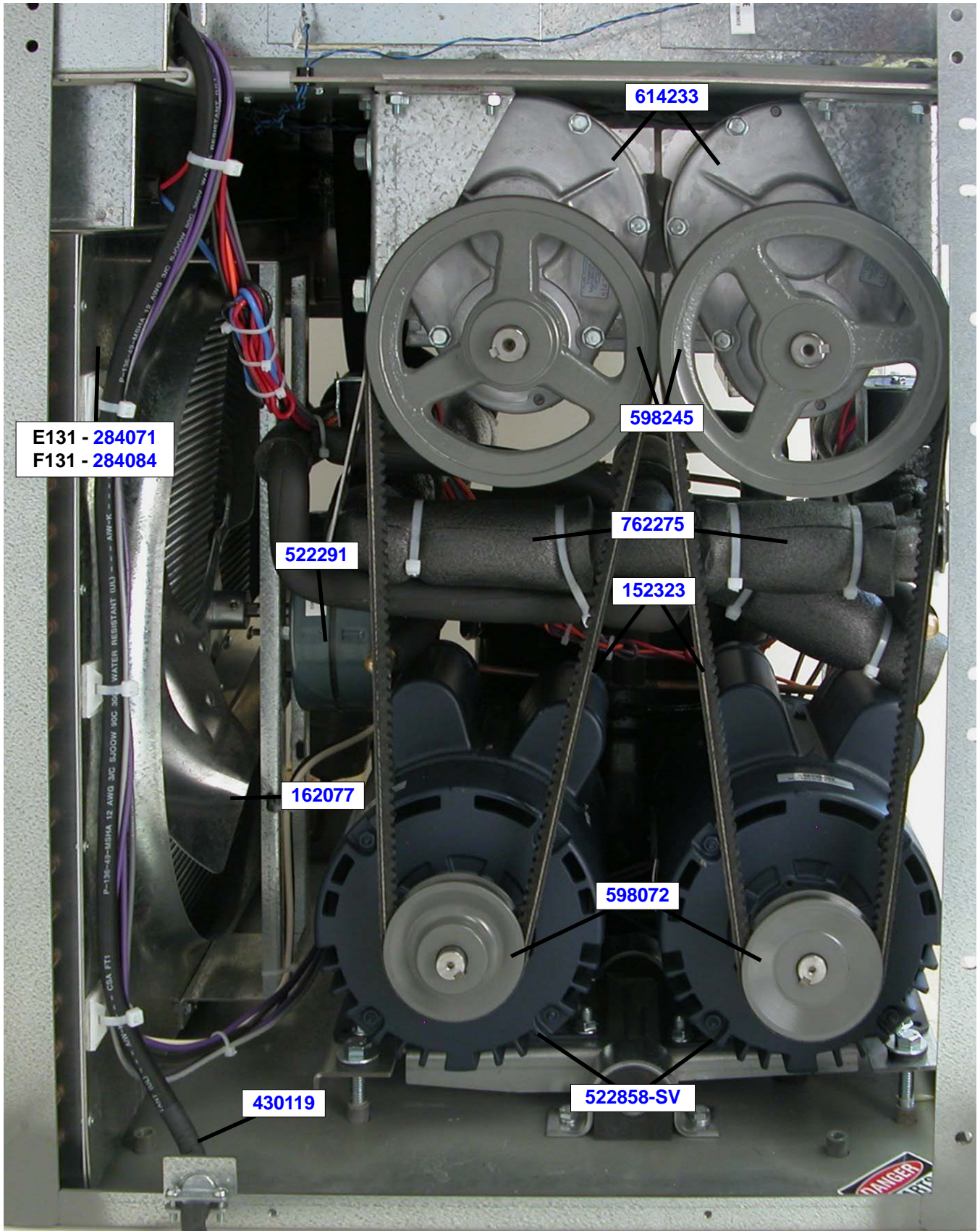

## 8.8 REAR (CONTINUED)

Part	Description	Quantity
152323	Belt - Grip-Notch (AX-39) (Each)	2
162077	Blade - Fan (Air-Cooled Condenser)	1
231096	Capacitor - Run (Motor)	1
231095	Capacitor - Start (Motor)	1
284071	Condenser (Air-Cooled)	1 (E131)
284084	Condenser (Air-Cooled)	1 (F131)
284104	Condenser (Water-Cooled)	1
368140	Filter - Air (Condenser)	1
430119	Cord - Power	1
522858-SV	Motor - Drive (60 Hz)	2
522859-SV	Motor - Drive (220V/240V 50 Hz)	2
522291	Motor - Fan (50/60 Hz)	1
598072	Pulley - Drive Motor (60 Hz)	2
598100	Pulley - Drive Motor (50 Hz)	2
598245	Pulley - Speed Reducer	2
614233	Speed Reducer	2
718710	High Pressure Cutout (Water-Cooled)	1 (F131)
762275	Valve - Magna Check	3
763181	Valve - Water (Water Cooled)	1 (F131)

## 8.9 SPIGOT CAM ASSEMBLY

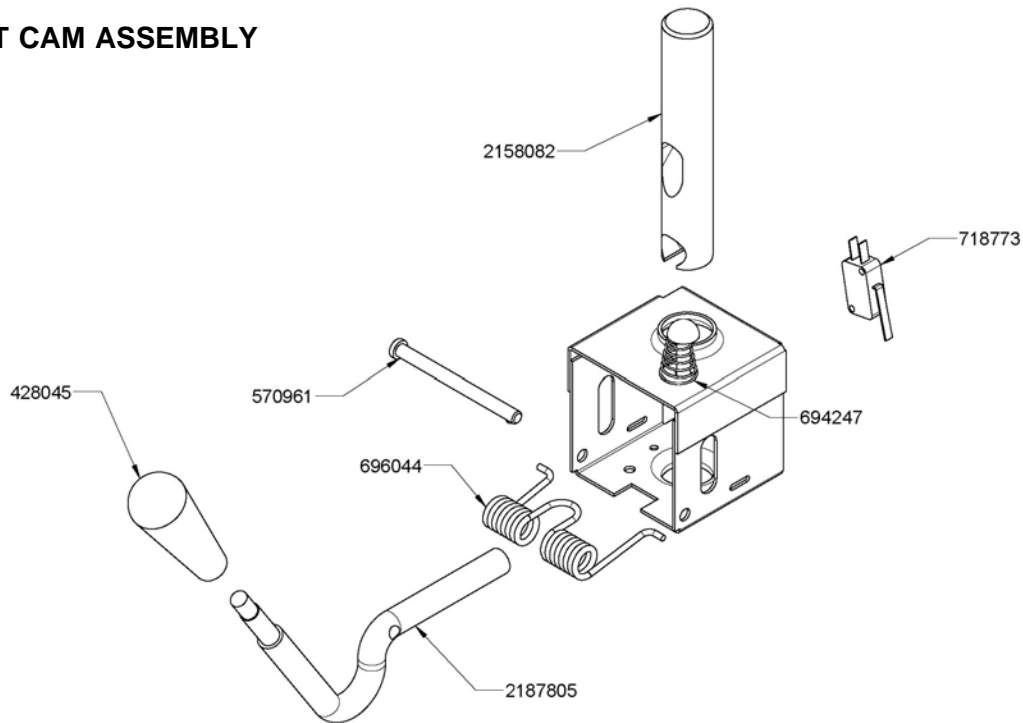

Part	Description	Quantity
428045	Knob - Spigot Handle (Black)	3
570961	Pin - Cotterless Clevis (Spigot Handle)	3
694247	Spring - Spigot Adjustment	3
696044	Spring - Torsion (Spigot Handle)	3
718773	Switch - Spigot (Micro)	4
2158082	Glide - Spigot Socket	3
2187805	Handle - Spigot	3

# 8.9 REFRIGERATION DIAGRAM & WIRING DIAGRAM

