



*Model U421 & U431
(Ser. #6374 Plus)
Operator's Manual
513725 Rev.0*

Section 1: Introduction

INTRODUCTION

OPERATION

MAINTENANCE

TROUBLESHOOTING

PARTS

This manual provides basic information about the machine. Instructions and suggestions are given covering its operation and care.

The illustrations and specifications are not binding in detail. We reserve the right to make changes to the machine without notice, and without incurring any obligation to modify or provide new parts for machines built prior to date of change.

DO NOT ATTEMPT to operate the machine until instructions and safety precautions in this manual are read completely and are thoroughly understood. If problems develop or questions arise in connection with installation, operation, or servicing of the machine, contact Stoelting.



stoeltingfoodservice.com

Stoelting Foodservice Equipment
502 Highway 67
Kiel, WI 53042-1600
U.S.A.

Main Tel: 800.558.5807
Fax: 920.894.7029

Customer Service: 888.319.9549
Fax: 800.545.0662
Email: foodservice@stoelting.com

© 2017 Stoelting

Section 1: Introduction

This manual is divided into the following five sections:

INTRODUCTION

- A. Parts of the Machine
- B. Specifications

OPERATION

- A. Empty the Freezing Cylinders - Start here if cleaning a machine with mix in it
- B. Disassemble Parts - Start here if cleaning an empty machine
- C. Cleaning Disassembled Parts
- D. Cleaning the Machine
- E. Assembling the Machine
- F. Sanitizing
- G. Freeze Down
- H. Brushes for Cleaning
- I. Lubrication Points
- J. Pump Hose Routing

MAINTENANCE

- A. Mix Pump Hose Replacement
- B. Mix Pump Hose Cleaning
- C. Fine Consistency Adjustment
- D. Daily Procedures - Night
- E. Daily Procedures Morning

TROUBLESHOOTING

- A. Troubleshooting Flow Charts

PARTS

- A. Auger Shaft & Front Door Parts
- B. Cab Tubing

INTRODUCTION

OPERATION

MAINTENANCE

TROUBLESHOOTING

PARTS

Section 1: Introduction

INTRODUCTION

OPERATION

MAINTENANCE

TROUBLESHOOTING

PARTS

A. Parts of the U421-I2 Machine



The U421 has two types of spigot handles, gate and pull-down. The gate style is opened by moving the handle to the left. The pull-down style is opened by pulling downwards.

This manual shows the pull-down handles which are self-closing. The gate style handles need to be closed when finished dispensing.

B. U421-I2 Specifications

Dimensions	U421-I2 A/C		U421-I2 A/C Remote		U421-I2 W/C	
	Machine	with crate	Machine	with crate	Machine	with crate
width	26-3/4" (67,9 cm)	34" (86,4 cm)	26-3/4" (67,9 cm)	34" (86,4 cm)	26-3/4" (67,9 cm)	34" (86,4 cm)
height	68-3/4" (174,6 cm)	78" (198,1 cm)	67-3/4" (172,1 cm)	78" (198,1 cm)	67-1/2" (171,5 cm)	78" (198,1 cm)
depth	39-1/2" (100,3 cm)	48" (121,9 cm)	39-3/4" (101,0 cm)	48" (121,9 cm)	39-1/2" (100,3 cm)	48" (121,9 cm)
Weight	785 lbs (356,0 kg)	930 lbs (421,8 kg)	760 lbs (344,7 kg)	930 lbs (421,8 kg)	760 lbs (344,7 kg)	930 lbs (421,8 kg)
Electrical	1 PH	3 PH	1 PH	3 PH	1 PH	3 PH
circuit ampacity (per barrel)	32A	20A	36A Left / 31A Right	20A	32A	20A
overcurrent protection device (per barrel)	50A	30A	50A Left / 45A Right	30A	50A	30A
The machine requires one dedicated electrical circuit per barrel.						
Compressor	Two - 19,000 Btu/hr Cabinet - 1,300 Btu/hr Compressor (R-134a)					
Drive Motor	Two - 2 hp					
Cooling	Air cooled units require 6" (15,2 cm) air space on all sides and open at the top.		Remote air cooled requires two remote condensers and two precharged line sets.		Water cooled units require 1/2" N.P.T. water and drain fittings. Maximum water pressure of 130 psi. Minimum water flow rate of 3 GPM per barrel. Ideal EWT of 50°-70°F. The machine requires 6" (15,2 cm) air space on all sides for the cabinet refrigeration system.	
Cabinet Volume	Two - 8 gallon (30,28 liters)					
Freezing Cylinder Volume	Two - 1.33 gallon (5,03 liters)					

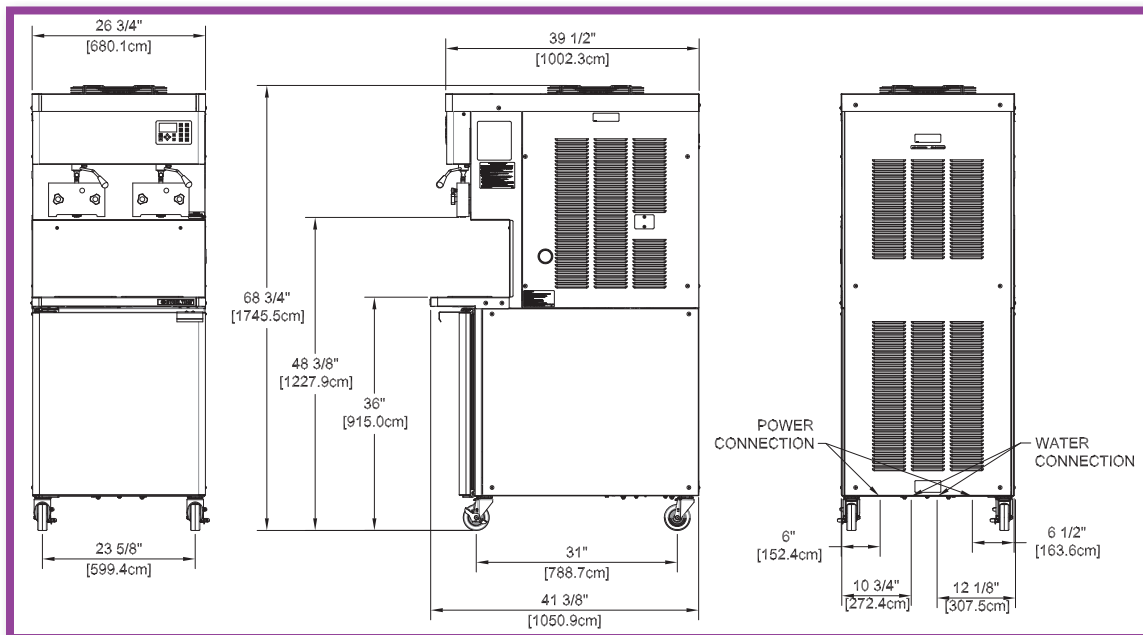

Section 1: Introduction

INTRODUCTION

OPERATION

MAINTENANCE

TROUBLESHOOTING

PARTS

C. Parts of the U431-I2 Machine



The U431 has two types of spigot handles, gate and pull-down. The gate style is opened by moving the handle to the left. The pull-down style is opened by pulling downwards.

This manual shows the pull-down handles which are self-closing. The gate style handles need to be closed when finished dispensing.

D. U431-I2 Specifications

Dimensions	U431-I2 A/C		U431-I2 A/C Remote		U431-I2 W/C	
	Machine	with crate	Machine	with crate	Machine	with crate
width	26-3/4" (67,9 cm)	34" (86,4 cm)	26-3/4" (67,9 cm)	34" (86,4 cm)	26-3/4" (67,9 cm)	34" (86,4 cm)
height	68-3/4" (174,6 cm)	78" (198,1 cm)	67-3/4" (172,1 cm)	78" (198,1 cm)	67-1/2" (171,5 cm)	78" (198,1 cm)
depth	39-1/2" (100,3 cm)	48" (121,9 cm)	39-3/4" (101,0 cm)	48" (121,9 cm)	39-1/2" (100,3 cm)	48" (121,9 cm)
Weight	785 lbs (356,0 kg)	935 lbs (424,1 kg)	760 lbs (344,7 kg)	930 lbs (421,8 kg)	760 lbs (344,7 kg)	930 lbs (421,8 kg)
Electrical						
circuit ampacity (per barrel)	1 PH	3 PH	1 PH	3 PH	1 PH	3 PH
overcurrent protection device (per barrel)	32A	20A	36A Left / 31A Right	20A	32A	20A
	50A	30A	50A Left / 45A Right	30A	50A	30A
The machine requires one dedicated electrical circuit per barrel.						
Compressor	Two - 19,000 Btu/hr Cabinet - 1,300 Btu/hr Compressor (R-134a)					
Drive Motor	Two - 2 hp					
Cooling	Air cooled units require 6" (15,2 cm) air space on all sides and open at the top.		Remote air cooled requires two remote condensers and two precharged line sets.		Water cooled units require 1/2" N.P.T. water and drain fittings. Maximum water pressure of 130 psi. Minimum water flow rate of 3 GPM per barrel. Ideal EWT of 50°-70°F. The machine requires 6" (15,2 cm) air space on all sides for the cabinet refrigeration system.	
Cabinet Volume	Two - 8 gallon (30,28 liters)					
Freezing Cylinder Volume	Two - 1.33 gallon (5,03 liters)					

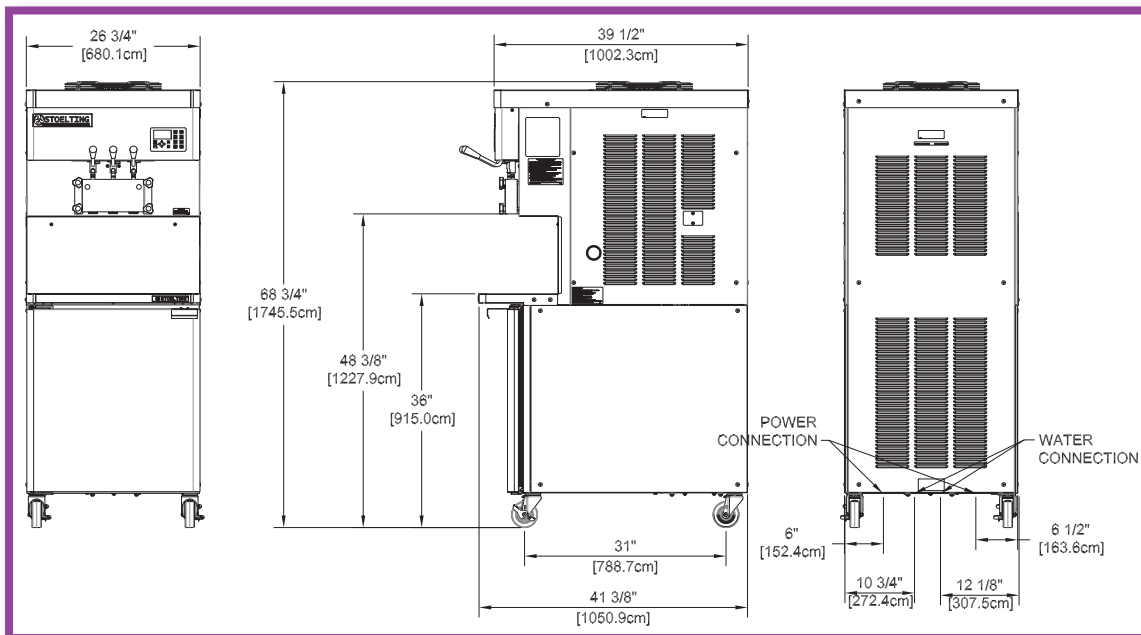

Section 2: Operation

INTRODUCTION

OPERATION

MAINTENANCE

TROUBLESHOOTING

PARTS

A. Empty the Freezing Cylinders

A.1

Turn off freezing cylinders.

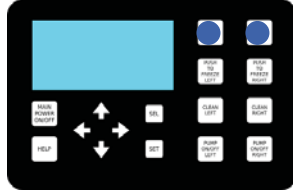

A.2

In the cab, remove the mix pickup assemblies and place them in a bucket filled with cool tap water.

Remove the mix containers and covers.

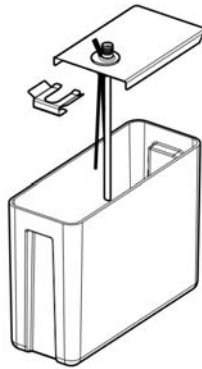

NOTE

Optional: Fill the bucket with Stera Sheen solution to make cleaning parts easier after disassembly.

NOTE

Clean mix containers on a regular basis. Refer to State and local health codes for frequency.

A.3

Press the Clean buttons.

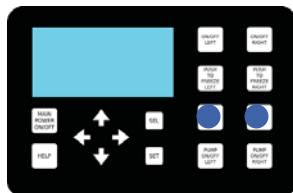

A.4

Open spigots to drain product into a container until the container is full. Empty the container and repeat until product has been drained from the freezing cylinders.



A.5

Refill the bucket in the cab with cool tap water (or Stera Sheen). Allow the freezing cylinders to fill then drain the water into a container. Repeat until the water draining from the freezing cylinders is clear.

NOTE

If the “Clean Time Exceeded” warning is displayed on the IntelliTec2™, turn the freezing cylinder on and off again and press the Clean button to clear the warning.

A.7

Remove any remaining water from the bucket in the cabinet.

Drain the water and press the Clean buttons to stop the augers.

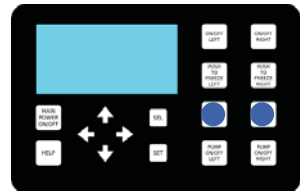

A.8

Remove the buckets in the cab and turn on the pumps to clear any remaining liquid in the hoses.

Open the spigots to drain the freezing cylinders.



A.9

Press and hold the Main Freezer Power button for three seconds to turn off the power.

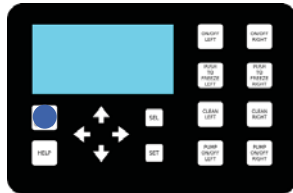

Auger Flight Wear

1. Front Door Disassembly

B.1

Remove the spigot extensions or rosette caps if installed.

Unscrew the knobs on the front door and remove the door.



B.2

Remove the front door o-rings and remove the spigots from the front door.



B.3

Remove the air bleed valve from the front door.



B. Disassemble Parts

Before using the machine for the first time, complete machine disassembly, cleaning and sanitizing procedures need to be followed. Routine cleaning intervals and procedures must comply with the local and state health regulations. Inspection for worn or broken parts should be made at every disassembly of the machine. All worn or broken parts should be replaced to ensure safety to both the operator and the customer and to maintain good machine performance and a quality product. Check the wear line on the auger flights on a regular basis and replace as needed.

Section 2: Operation

INTRODUCTION

OPERATION

MAINTENANCE

TROUBLESHOOTING

PARTS

B.4

Remove all o-rings from parts by first wiping off the lubrication using a clean towel. Then squeeze the o-ring upward to form a loop. Roll the o-ring out of the groove.

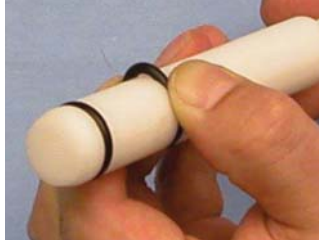

2. Removing Auger

B.5

Remove front auger supports and bushings and remove the augers from the freezing cylinders. As the augers are being pulled out, remove the plastic flights with springs.



B.6

Wipe any remaining lubricant off the hex end of the auger and remove the rear seal assembly and o-ring. Wipe any remaining lubricant off the o-ring and auger.



Remove the rear seal adapter from the rear seal.

B.7

Unscrew springs from the auger flights.



3. Disassemble Pump Hose

B.8

Disconnect the sensor connectors from the pickup assemblies and unscrew the hose clamps nearest the assemblies.



Remove the mix pickup assemblies.

B.9

Remove the lock clips from the check valves and remove the check valves and springs.



Detach the check valve from the spring.

B.10

Remove the o-rings from the assemblies.



B.11

If the pump hoses require cleaning and inspection, follow the steps in Section 3.

C. Cleaning Disassembled Parts

Disassembled parts require complete cleaning, sanitizing and air drying before assembling. Local and state health codes will dictate the procedure required. Some state health codes require a four sink process (pre-wash, wash, rinse, sanitize, air dry), while others require a three sink process (without the pre-wash step). The following procedures are a general guideline only. Consult your local and state health codes for the procedures required in your location.

C.1

Place all parts in 90° to 110°F (32°C to 43°C) mild detergent water and wash thoroughly. **Use the brushes that shipped with the machine** to clean all holes in the front door, flights, mix pickup assembly, etc.



NOTE

Be sure to use the brushes that shipped with the machine to properly clean the parts.

C.2

Rinse all parts with clean 90° to 110°F (32°C to 43°C) water. Then place all parts in a sanitizing solution for at least 1 minute, then remove and let air dry completely before assembling in machine.

D. Cleaning the Machine

D.1

Using a detergent solution and the large barrel brush provided, clean the freezing cylinders by dipping the brush in the solution and brushing the inside of the freezing cylinders.



Make sure to thoroughly clean the rear seal surfaces on the inside of the freezing cylinders.

D.2

Wrap the brush in a clean cloth and thoroughly dry the freezing cylinder.

D.3

Remove the drain tray from the side of the machine. Remove the drip tray from the front panel. Clean and replace the trays.



D.4

The exterior of the machine should be kept clean at all times to preserve the luster of the stainless steel. A high grade of stainless steel has been used on the machine to ease cleanup. To remove spilled or dried mix, wash the exterior with 90° to 110°F (32°C to 43°C) mild detergent water and wipe dry.

Do not use highly abrasive materials, as they will mar the finish. A mild alkaline cleaner is recommended. Use a soft cloth or sponge to apply the cleaner. For best results, wipe with the grain of the steel.

Section 2: Operation

INTRODUCTION

OPERATION

MAINTENANCE

TROUBLESHOOTING

PARTS

E. Assembling Machine

NOTE

Total Blend or equivalent must be used when lubrication of machine parts is specified.

The USDA and FDA require that lubricants used on food processing equipment must be certified for this use. Use lubricants only in accordance with the manufacturer's instructions.

NOTE

Stoelting recommends allowing the parts to air dry before assembling.

E.1

Install the rear seal o-rings onto the augers. Lubricate the outside of the o-rings with a generous amount of sanitary lubricant.



E.2

Install the stainless steel adapter into the rear seal WITHOUT LUBRICANT. Then lubricate the inside of the adapter and install it onto the auger.

DO NOT lubricate the outside of the rear seal.



E.3

Lubricate the hex end of the auger with Total Blend.



Section 2: Operation

E.4

Screw the springs onto the studs in the plastic flights. The springs must be screwed into the flights completely to provide proper compression.



E.5

Install the two plastic flights onto the rear of the auger and insert it part way into the freezing cylinder.



E.6

Install the remaining plastic flights, push the auger into the freezing cylinder and rotate slowly until the auger engages the drive shaft.



E.7

Apply a thin layer of sanitary lubricant to the inside and outside of the auger support bushing.



Section 2: Operation

INTRODUCTION

OPERATION

MAINTENANCE

TROUBLESHOOTING

PARTS

E.8

Install the bushing onto the auger support and install the auger support into the front of the auger. Rotate the auger support so that one leg of the support points straight up.



E.10

Insert the air bleed valve into the back of the front door. Install the compression spring onto the air bleed valve then screw the knob on finger tight.



E.9

Assemble the air bleed valve o-ring onto the air bleed valve. Position the o-ring into the groove. Apply a thin film of sanitary lubricant to the o-ring.



E.11

Install the o-rings onto the spigots. Apply a thin layer of sanitary lubricant to the o-rings on the spigot bodies and install the spigot bodies through the bottom of the front door.



E.12

Fit the front door o-rings into the grooves on the rear of the front door.



E.13

Place the front door assembly on the mounting studs and the push front door against the machine carefully.



NOTE

Make sure the pins on the front door do not touch the legs of the auger supports.

E.14

Secure the front door to the machine by placing the knobs on the studs and tightening until finger tight. Tighten in a crisscross pattern. Do not overtighten. Proper o-ring seal can be observed through the transparent front door.



E.15

Assemble the mix pickup assemblies:

1. Install the o-rings onto the mix pickup tubes and apply a thin layer of sanitary lubricant to the o-rings.
2. Install the rubber check valves into the springs and insert (spring first) into the check valve bodies.
3. Insert the mix pickup tubes into the check valve bodies and secure them with the lock clips.



E.16

Place the mix containers on the shelf in the cabinet.



E.17

Install the mix pickup assemblies in the cab using the hose clamps.



Section 2: Operation

INTRODUCTION

OPERATION

MAINTENANCE

TROUBLESHOOTING

PARTS

F. Sanitizing

Sanitizing must be done after the machine is clean and just before the machine is filled with mix. Sanitizing the night before does not ensure sanitization the next day. However, you should always clean the machine and parts after using it.

NOTE

The United States Department of Agriculture and the Food and Drug Administration require that all cleaning and sanitizing solutions used with food processing equipment be certified for this use

When sanitizing the machine, refer to local sanitary regulations for applicable codes and recommended sanitizing products and procedures. The frequency of sanitizing must comply with local health regulations. Mix sanitizer in quantities of no less than 2 gallons of 90°F to 110°F (32°C to 43°C) water. Allow sanitizer to contact the surfaces to be sanitized for 5 minutes. Any sanitizer must be used only in accordance with the manufacturer's instructions and to provide a 100 parts per million strength solution.

F.1

Prepare 2 gallons of sanitizing solution for each freezing cylinder. Following the sanitizer manufacturer's instructions for preparing the sanitizing solution.



Pour the sanitizing solution into the mix containers.

F.2

Press the Main Power button. Then press the Pump buttons to turn the pumps ON.

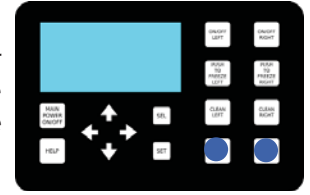

F.3

Check for leaks when the freezing cylinder is first pressurized with sanitizing solution.

1. Check for leaks at the front door seals.
2. Check the drain tray located in the side panel for leaks coming from the rear seal of the auger.
3. Check the inside of the cab unit for leaks at the hose connections.

F.4

After you hear the pump shut off, press the air bleed valves to release the air pressure. Allow water to fill the freezing cylinders.



F.5

Press the CLEAN buttons to start the augers rotating. The IntelliTec2™ display shows a 5-minute timer.

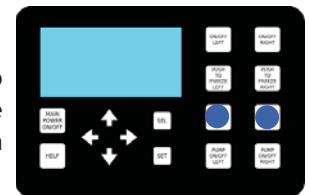

F.6

While the cylinders are being sanitized complete the following:

1. Use a sanitized soft bristle brush dipped in sanitizing solution to clean the mix containers.
2. Empty the sanitizer from the containers.
3. Install the mix pickup assemblies into the covers using the retaining clips. Install the mix sensor wires onto the assemblies.
4. Install spigot extensions and rosette capes (if applicable).



G.1

Fill each mix container with at least 3 gallons of mix.

Close the cab door.

Press the Pump buttons to turn the pumps on.



G.2

Place a container under the spigot and open the spigot to allow the mix to flush out about 8 ounces (0.23 liters) of sanitizing solution and liquid mix.



F.7

After the five minute timer expires, open the spigots to drain the sanitizing solution into a container.

When the solution has drained, press the Pump and Clean buttons to stop the pump and auger. Allow the freezing cylinder to drain completely. The machine is now sanitized and ready for adding mix.



G.3

Allow cylinders to fill until the pumps shut off. Press the valves to release pressure in the cylinders.

The cylinders will be filled to the proper level after the pumps shut off the second time.

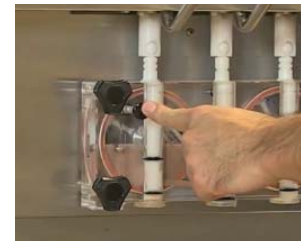

G. Freeze Down

Sanitize immediately before use.

Make sure the display shows the freezing cylinders are off. If they are not, press the On/Off Left or On/Off Right button to turn them off.

G.4

Press the On/Off buttons to turn on the freezing cylinders then press the Push to Freeze buttons.

When the product is ready, the display will read "SERVE" or "SERVE 2". Open the spigot to dispense product.



Section 2: Operation

INTRODUCTION

OPERATION

MAINTENANCE

TROUBLESHOOTING

PARTS

I. Lubrication Points

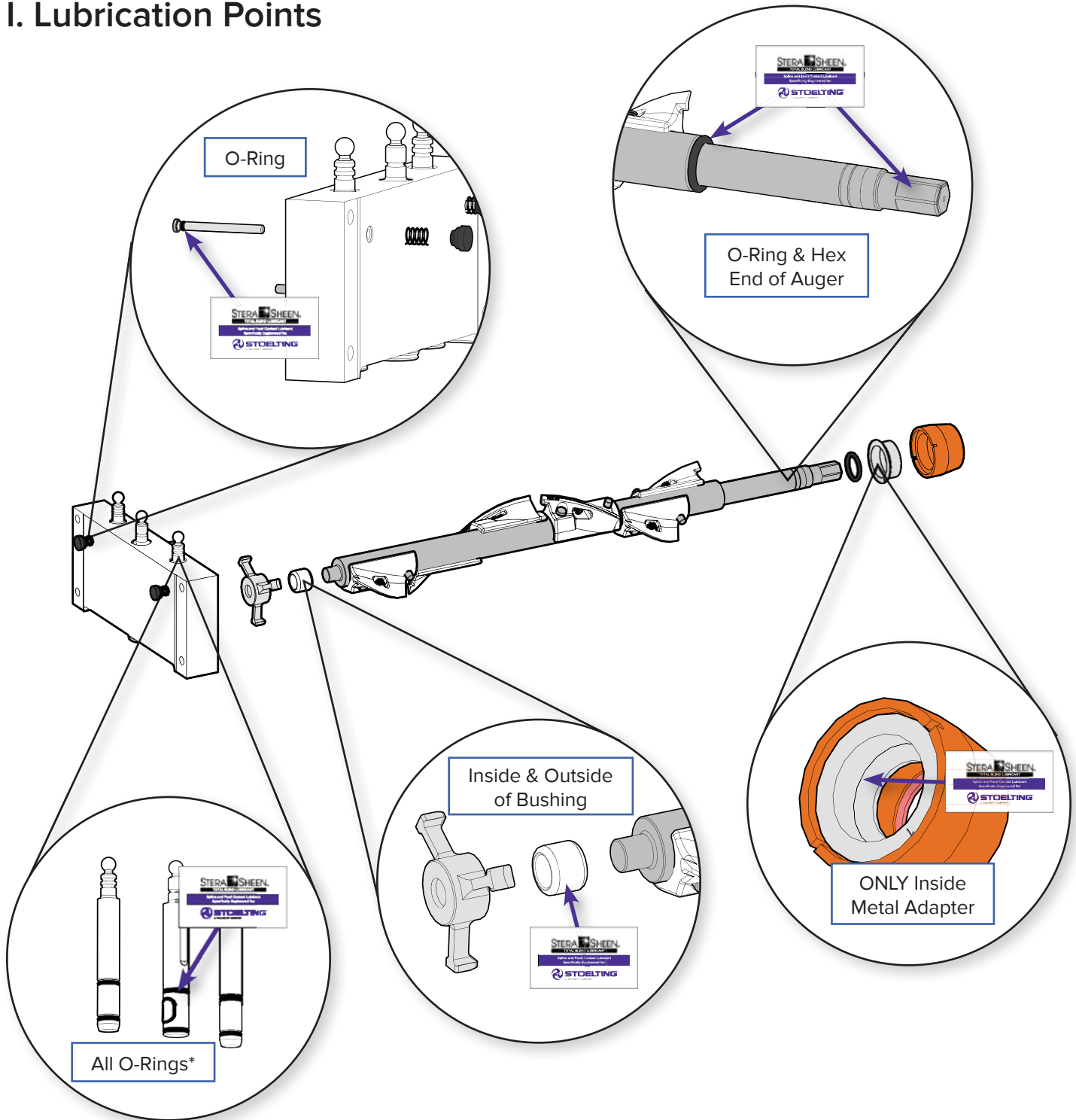

* U431 spigot bodies shown, U421 have two spigots

J. Pump Hose Routing

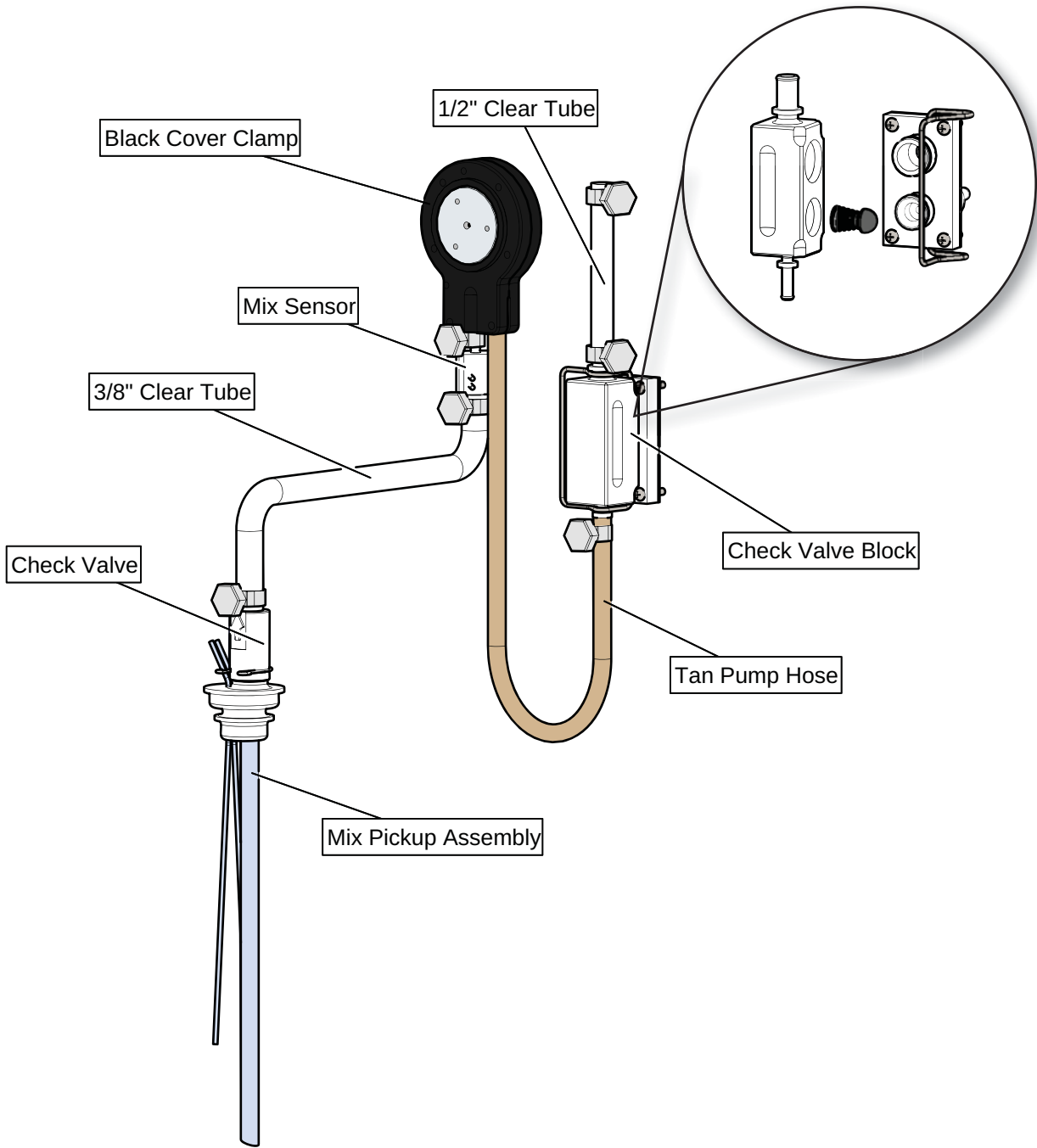

Section 3: Maintenance

INTRODUCTION

OPERATION

MAINTENANCE

TROUBLESHOOTING

PARTS

A. Mix Pump Hose Replacement

NOTE

Replace pump hose every 800 gallons or every 2 weeks, whichever occurs first.

Replace the hose during the cleaning process.

A.1

Turn the pump on and pull down on the pickup end of the tan hose until a few inches of tubing is visible. The pickup end is on the left side.



Then turn the pump off.

A.2

Loosen the clamps on the tan hose at the mix sensor and check valve block.

Disconnect the hose at both ends.



A.3

Turn the pump on and pull the hose out of the black cover.

Then turn the pump off.

A.4

Rotate the pump rollers so one of the rollers is at the 6:00 position.

With a brush, clean the roller assembly with detergent water, then with clear water.



A.5

Connect a new length of tan hose to the mix sensor using a clamp.



A.6

Turn the pump on and feed the other end of the tan hose into the left side of the black cover.

Face the natural curve of the tan hose towards the outside of the cover to prevent the hose from looping around twice.



A.7

As the hose feeds through the cover, orient the mix sensor at an angle so the sensor wire is not kinked or bent at a sharp angle.

Then turn the pump off.

Connect the hose to the check valve block.

A.8

Press and hold the Pump buttons until the pump hose reset message appears on the screen.

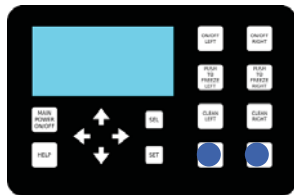

A.9

Continue normal cleaning and sanitizing procedures.

Section 3: Maintenance

INTRODUCTION

OPERATION

MAINTENANCE

TROUBLESHOOTING

PARTS

B. Mix Pump Hose Cleaning

NOTE

Any cleaning procedure must always be followed by sanitizing before filling the machine with mix.

The mix pump is approved for CIP (clean-in-place). It is thoroughly cleaned when the cleaning solution is pumped through the machine.



WARNING

Hazardous Moving Parts

Revolving pump head can grab, mangle, and cause serious crushing injury. Make sure the display shows the freezing cylinders and pump are off. If they are not, press the On/Off button and Pump button to turn them off.

CAUTION

System Under Pressure

Never disconnect hoses from the machine or the pump without first opening the spigot to relieve pressure.

1. Disassembly and Hose Cleaning

B.1

Disconnect the wires from the low mix sensor.

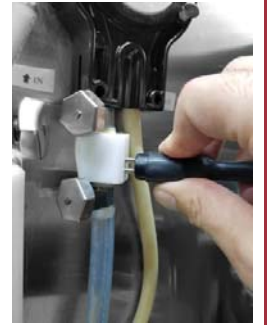

B.2

Turn the pump on and pull down on the pickup end of the tan hose until a few inches of tubing is visible. The pickup end is on the left side.

Then turn the pump off.

Loosen the clamp on the tan hose and disconnect the hose at the low mix sensor.



B.3

Turn the mix pump on and pull the tan house out of the black cover clamp then turn the mix pump off.

B.4

Unfasten the wire clamp on the check valve block by swinging the clamp to the right. Remove the check valve.



B.5

Loosen the clamp on the mix tube at the top of the cab and remove the hose from the tube.

B.6

Remove the two o-rings from the base of the check valve block.



B.7

Remove the hose assemblies from the cab.
Loosen all clamps and disconnect all hoses from the low mix sensor and check valve block.

2. Inspect and Cleaning

B.8

Inspect all the parts for wear and replace as necessary.

B.9

Thoroughly clean the parts with 90° to 110°F detergent water and brushes provided. Rinse with clean, 90° to 110°F water.

B.10

Wash the mix tube and the check valve base in the cabinet with the detergent water and brushes. Rinse with clean, 90° to 110°F water.



Section 3: Maintenance

INTRODUCTION

OPERATION

MAINTENANCE

TROUBLESHOOTING

PARTS

3. Reassembly

B.11

Connect the clear hose to the low mix sensor.



B.12

Connect the tan hose to the low mix sensor.

B.13

Turn the pump on and feed the tan hose into the left side of the black cover clamp.



NOTE

Face the natural curve of the tan hose towards the outside of the cover to prevent the hose from looping around twice.

B.14

Once the hose feeds through the cover, turn the pump off.

B.15

Connect the tan hose to the bottom of the check valve block. The bottom of the block has the smaller hose connector.

Section 3: Maintenance

B.16

Install the o-rings onto the base of the check valve block. Apply a thin layer of sanitary lubricant to the o-rings.



B.17

Connect the clear hose to the top of the check valve block and tighten the clamp.

Insert the other end of the clear hose onto the mix tube at the top of the cabinet. Do not tighten the clamp until the check valve block is installed.

B.18

Install the check valve into the block and secure the block with the wire clamp. Make sure the rubber check valve is installed in the bottom seat of the assembly.



B.19

Adjust the clear hose so that it is not kinked and tighten the clamp holding the hose to the mix tube.

B.20

Connect the low mix sensor wires to the sensor



B.21

Sanitize assembled machine as per instructions outlined in Section 2 F.

Section 3: Maintenance

INTRODUCTION

OPERATION

MAINTENANCE

TROUBLESHOOTING

PARTS

C. Fine Consistency Adjustment

Product consistency can be adjusted on the Fine Consistency Adjustment Screen.

C.1

From the Current Status screen, press the left arrow button to access the password screen.

Current Status	01/01/01
	12:34:56
Left	Serve
Right	Sleep 1
Storage Left	On
Storage Right	On
_ Service Company	

Press the right arrow then the SEL button.

C.2

Press the SET button on the Fine Consistency Adjustment screen. And use the arrows to change the value.

Fine Consistency Adjustment	
Cylinder	Right
Changing the fine consistency changes the firmness of the product.	
Consistency CutIn Limit	00
Consistency CutOut Limit	00
_ Fine Consistency	00.0

Increase the value for higher consistency (thicker). Change the +/- symbol to "-" and adjust the value for lower consistency (thinner) product.

Make adjustments in increments of 5 for best results. Allow 3-4 draws or 30 minutes for the changes to take effect.

C.3

Press the SET button to save the changes.

Press the SEL button to toggle between freezing cylinders.

C.4

Press the left arrow button when done to return to the Current Status screen.

Section 3: Maintenance Daily Procedures

D. Daily Procedures - Night

D.1

Remove the drip tray from the front panel. Clean the tray and reinstall it.



D.2

Remove the spigot extensions. Clean and sanitize them and let them air dry.

D.3

Clean the underside of the clear front door and the exposed portion of the spigots with mild detergent water and then with sanitizing solution.

D.4

Wipe the exterior clean with a mild detergent water to remove spilled or dried mix and wipe dry.

E. Daily Procedures - Morning

E.1

Clean the underside of the clear front door and the exposed portion of the spigots with brushes and a mild detergent water and then with sanitizing solution.

E.2

Install the spigot extensions.

E.3

Check the mix level of the mix bags in the cab.
Add new mix bags as necessary.

E.4

Press the Push To Freeze button to start freezing the product.

When the product is ready, the display will read "SERVE" or "SERVE 2". Open the spigot to dispense product.



Section 4: Troubleshooting

INTRODUCTION
OPERATION
MAINTENANCE
TROUBLESHOOTING
PARTS

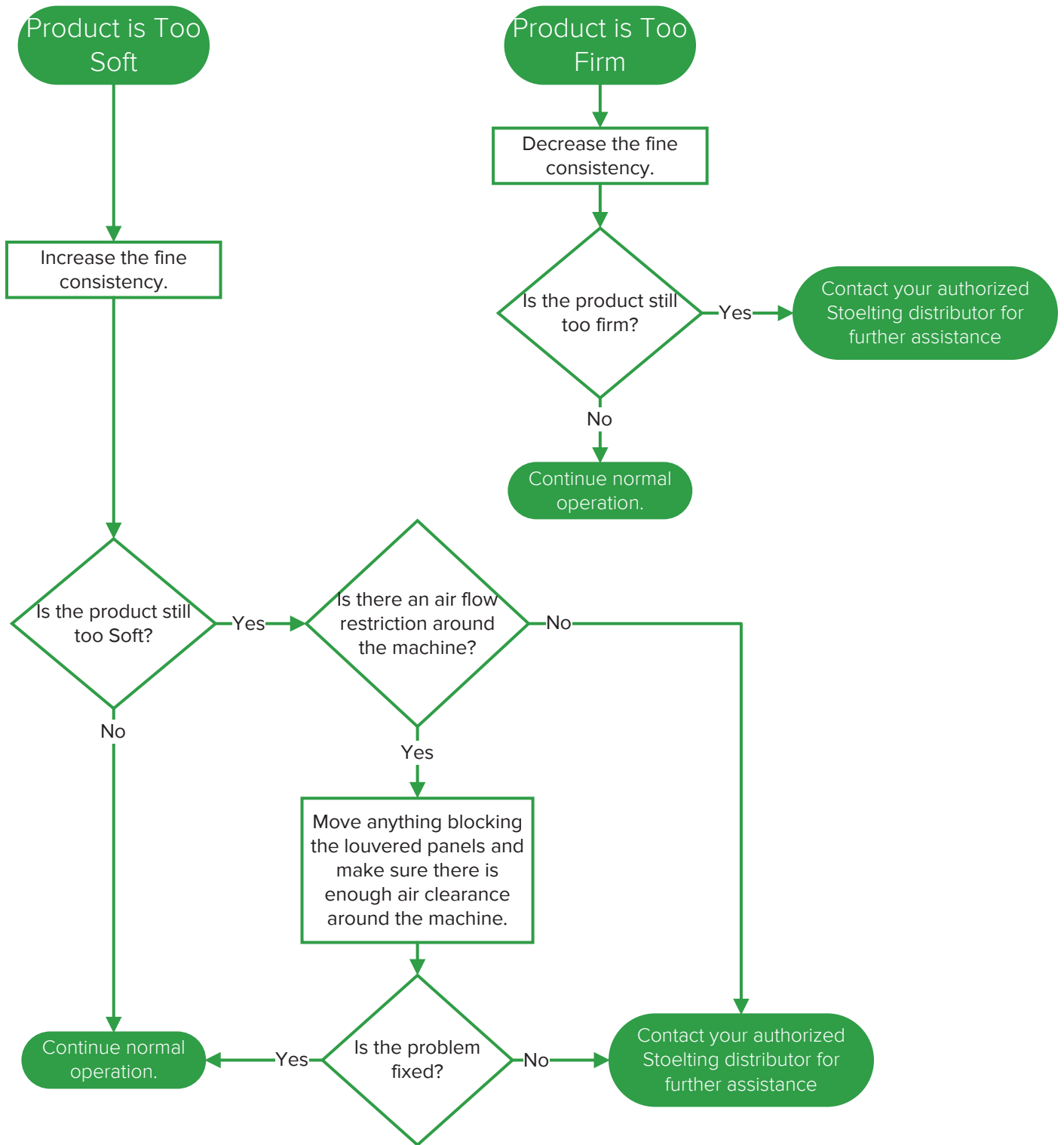

Section 4: Troubleshooting

If an error code appears on the machine complete the steps on the following pages before calling your authorized Stoelting distributor. Oftentimes the issues can be resolved using new/fresh product in a clean and sanitized machine.

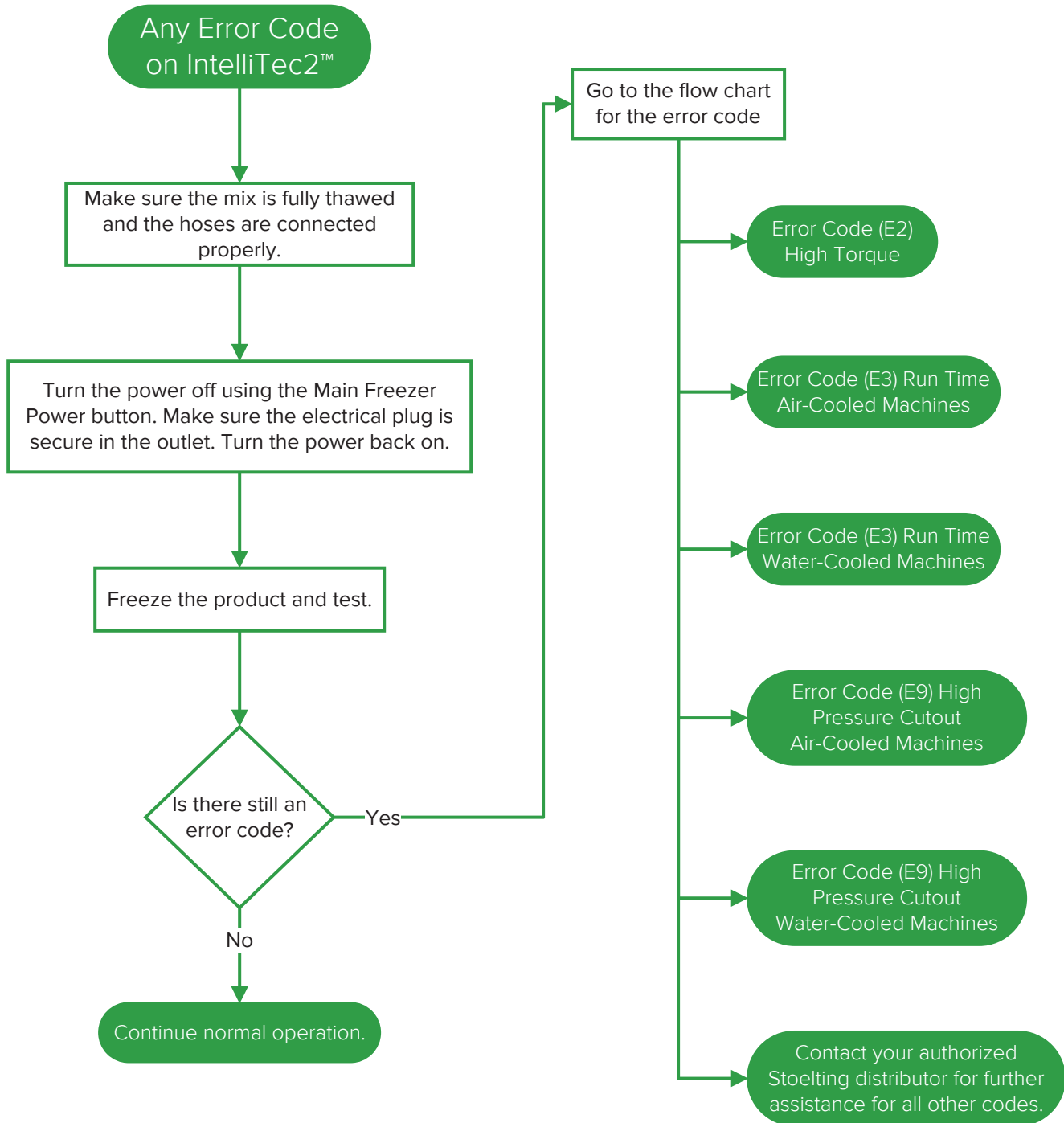

Section 4: Troubleshooting

INTRODUCTION
OPERATION
MAINTENANCE
TROUBLESHOOTING
PARTS

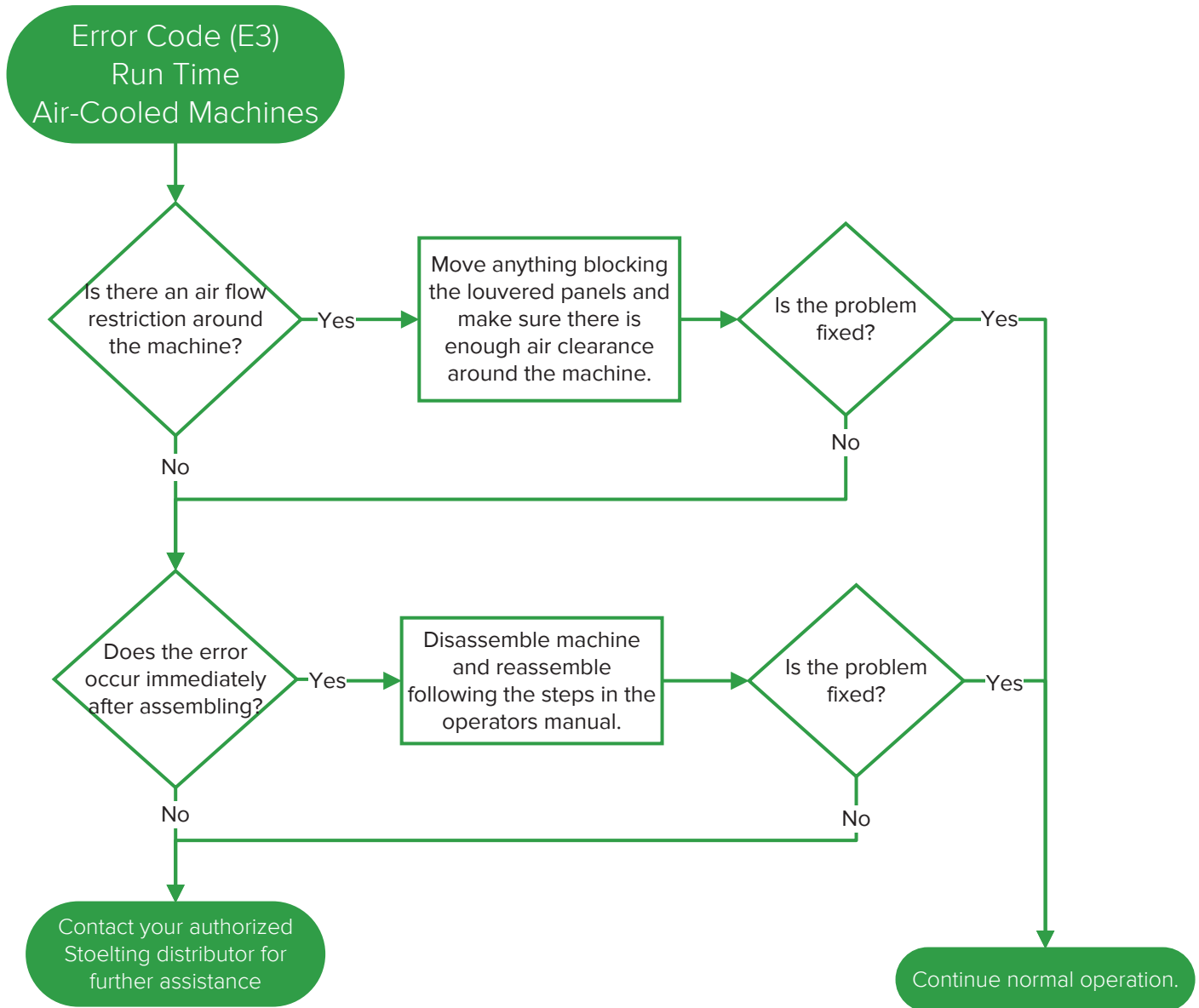

Section 4: Troubleshooting

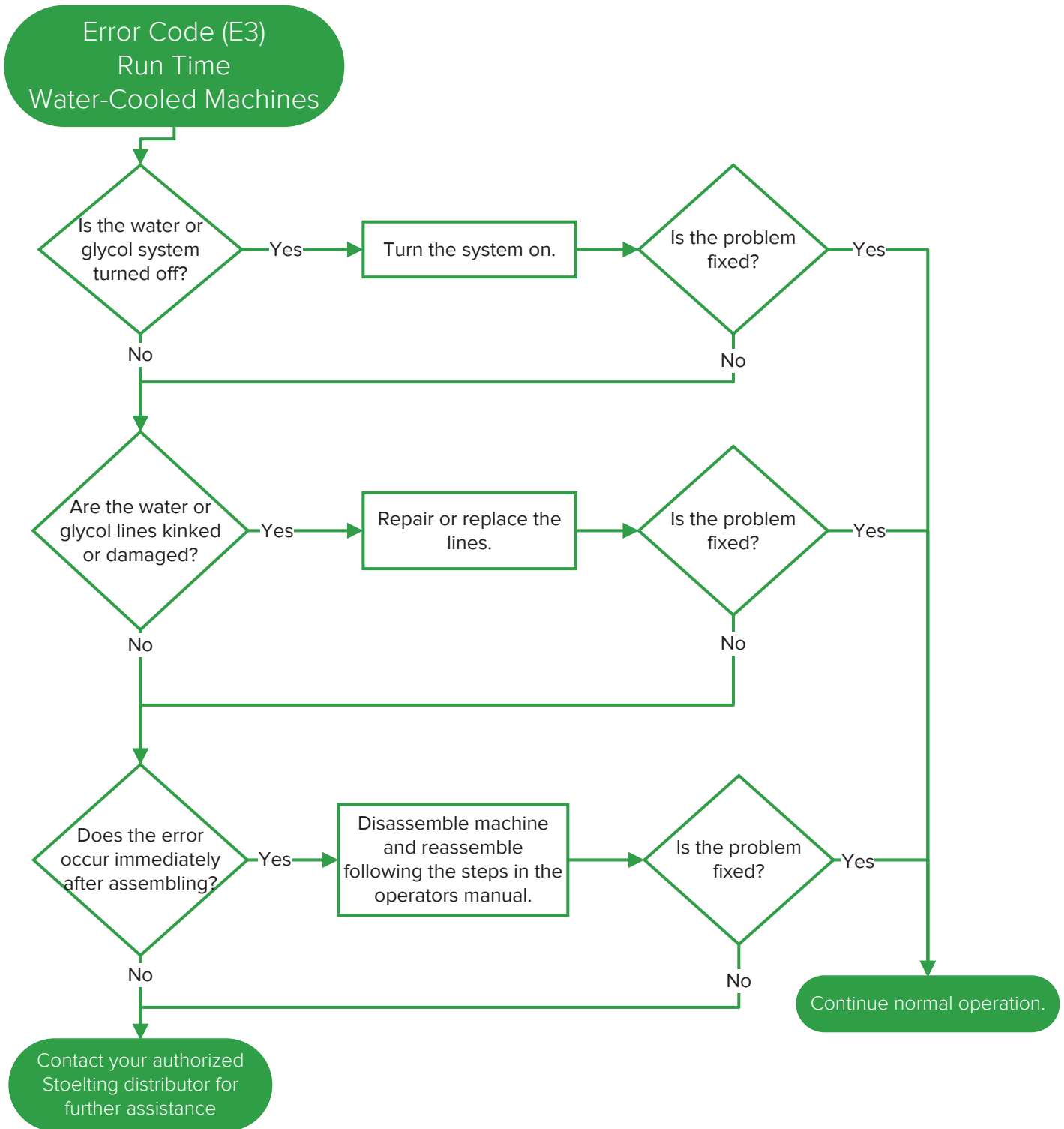

Section 4: Troubleshooting

INTRODUCTION
OPERATION
MAINTENANCE
TRUBLESHOOTING
PARTS

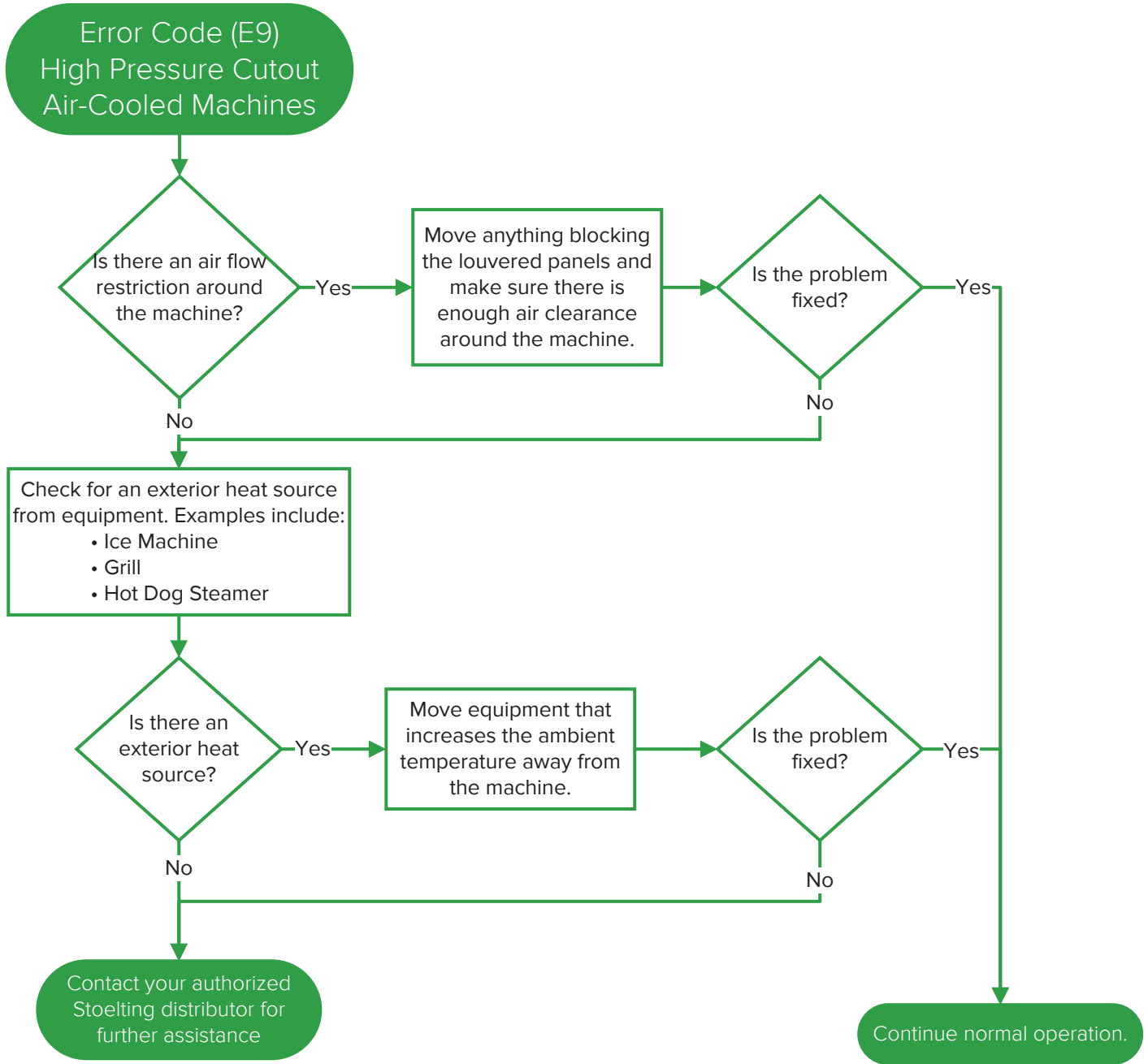

Section 4: Troubleshooting

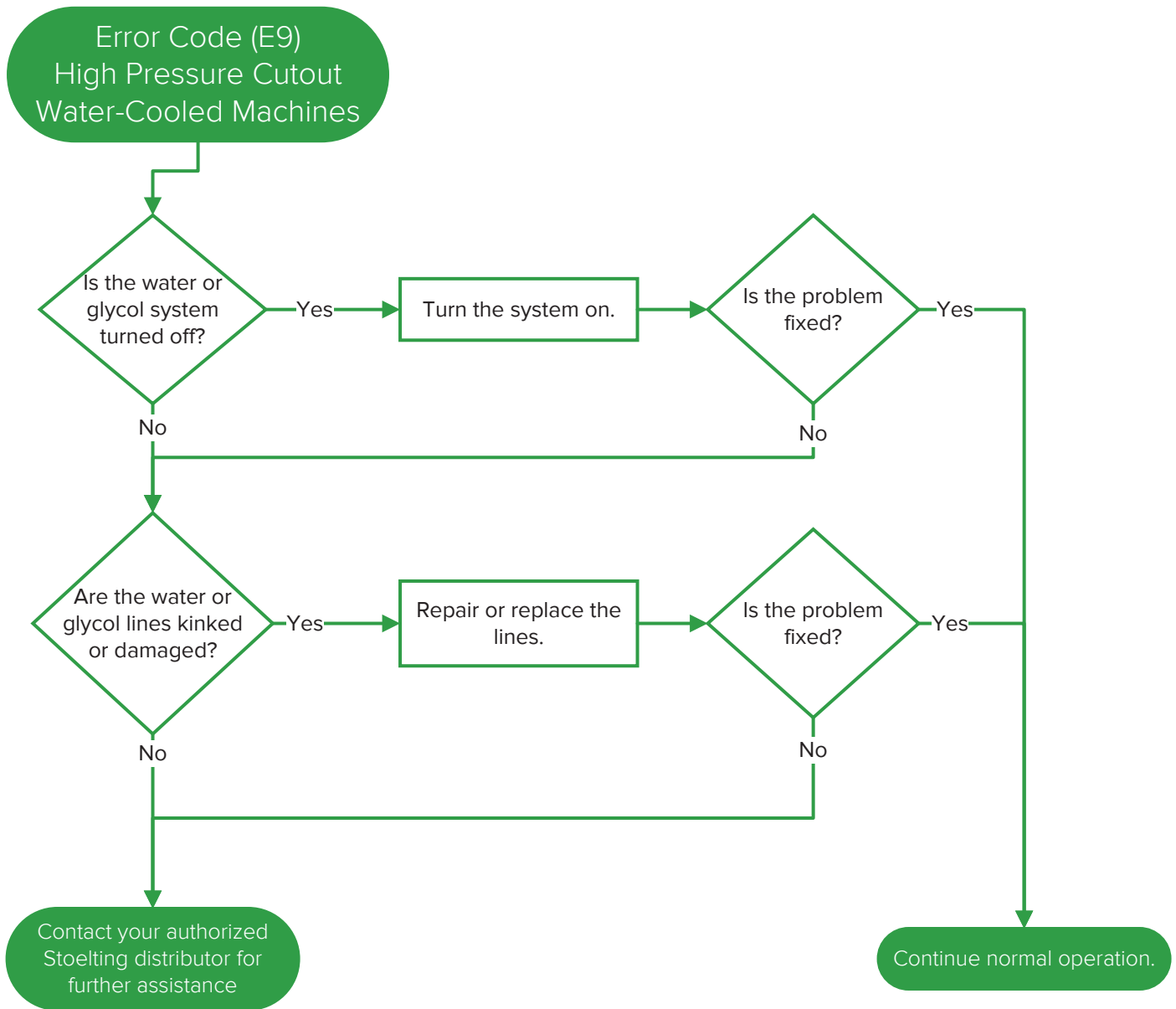

INTRODUCTION

OPERATION

MAINTENANCE

TROUBLESHOOTING

PARTS

Section 5: Replacement Parts

INTRODUCTION

OPERATION

MAINTENANCE

TROUBLESHOOTING

PARTS

A.1 U421-I2 Auger Shaft & Front Door Parts

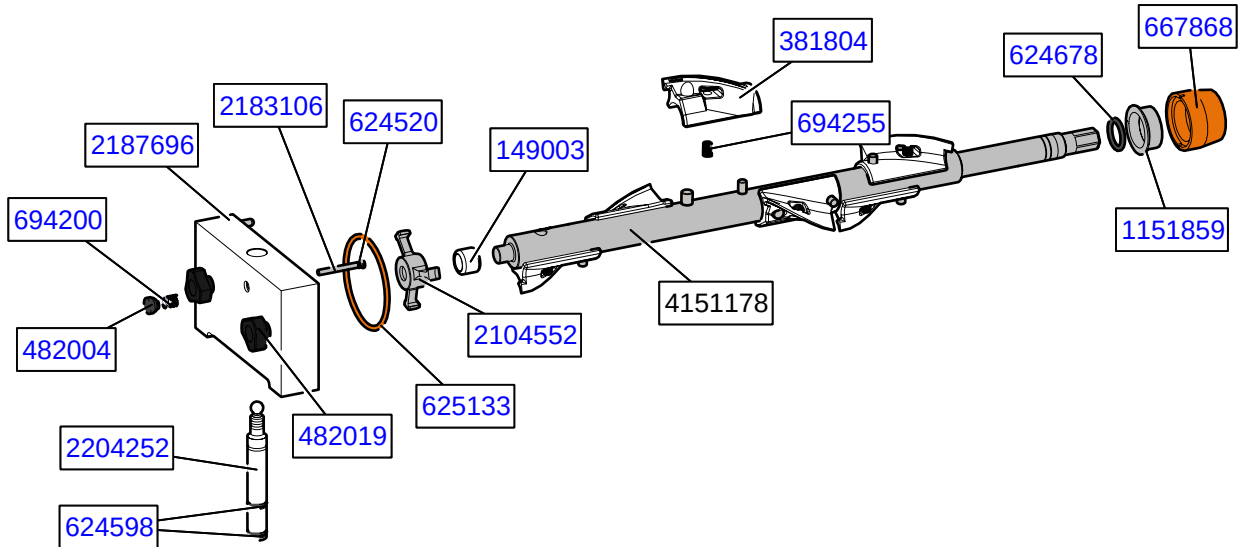

Part Number	Description	Quantity
149003	Bushing - Front Auger Support	2
381804	Auger Flight	12
482004	Knob (Air Bleed Valve)	2
482019	Knob - Front Door (Black)	4
624520	O-Ring - Air Bleed Valve - Black	2
624598	O-Ring - Spigot - Black	4
624678	O-Ring - Rear Seal - Black	2
625133	O-Ring - Front Door - Black	2
667868	Seal - Rear Auger (Orange)	2
694200	Spring - Air Bleed Valve	2
694255	Spring - Auger Flight	12
1151859	Adapter - Rear Seal (Code 1)	2
2183106	Valve - Air Bleed	2
2104552	Support - Front Auger	2
2187696	Front Door	2
2204252	Spigot Body	2
4151178	Auger Shaft	2

A.2 U431-I2 Auger Shaft & Front Door Parts

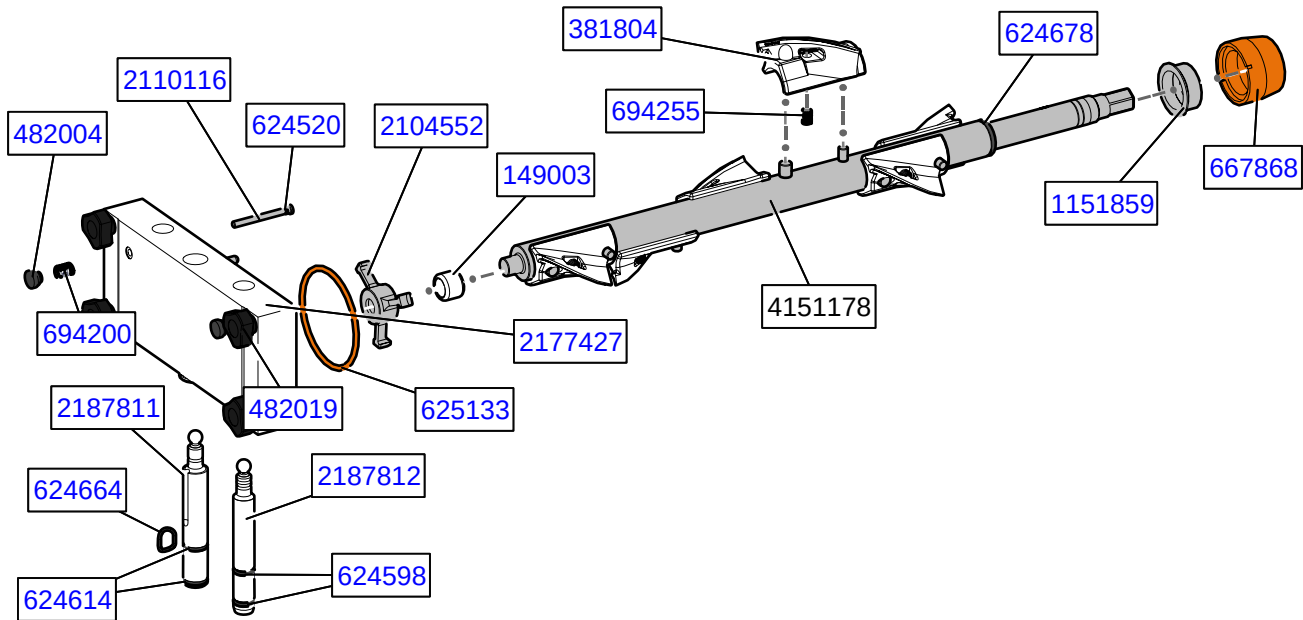

Part Number	Description	Quantity
149003	Bushing - Front Auger Support	2
381804	Auger Flight	12
482004	Knob (Air Bleed Valve)	2
482019	Knob - Front Door (Black)	4
624520	O-Ring - Air Bleed Valve - Black	2
624598	O-Ring - Outside Spigot - Black	4
624614	O-Ring - Top & Bottom Center Spigot - Black	2
624664	O-Ring - Middle Center Spigot - Black	1
624678	O-Ring - Rear Seal - Black	2
625133	O-Ring - Front Door - Black	2
667868	Seal - Rear Auger (Orange)	2
694200	Spring - Air Bleed Valve	2
694255	Spring - Auger Flight	12
1151859	Adapter - Rear Seal (Code 1)	2
2104552	Support - Front Auger	2
2110116	Valve - Air Bleed	2
2177427	Front Door	1
2187811	Spigot Body - Center	1
2187812	Spigot Body - Outer	2
4151178	Auger Shaft	2

Section 5: Replacement Parts

INTRODUCTION

OPERATION

MAINTENANCE

TROUBLESHOOTING

PARTS

A.2 Cab Tubing

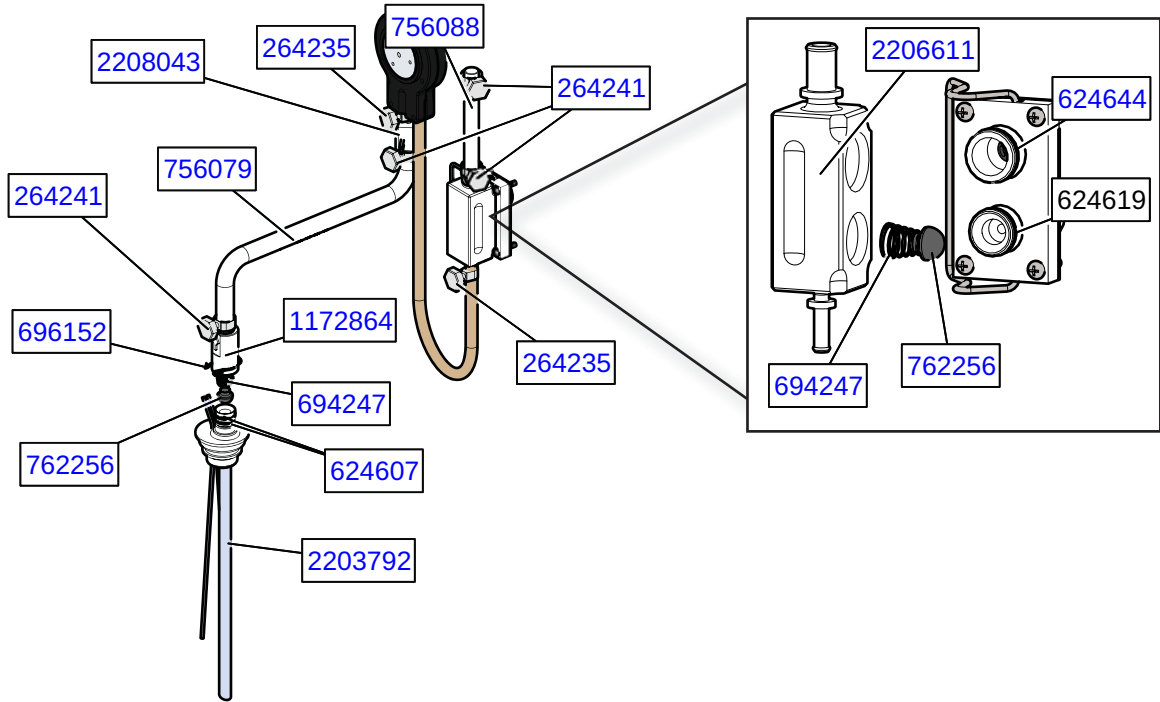

Part Number	Description	Quantity
264235	Clamp - Metal (1/4" ID Tubing)	-
264241	Clamp - Metal (1/2" ID Tubing)	-
558109	Mix Container Only	2
624607-5	O-Ring - Check Valve Body - Black (5 Pack)	4
624616-5	O-Ring - Check Valve Block - Lower - Black (5 Pack)	2
624644-5	O-Ring - Check Valve Block - Upper - Black (5 Pack)	2
694247	Spring - Check Valve	2
696152	Clip - Lock (Check Valve)	2
756079	Tubing - 3/8" ID - Clear	2
756088	Tubing - 1/2" ID - Clear	2
756204	Tubing - 1/4" ID - Pump (50' Box Only) (Per Inch)	-
756204-24	Tubing - 1/4" ID - Pump (Pre-Cut 24" Piece)	2
762256	Check Valve	2
2206611	Check Valve Block	2
2208043	Sensor - Mix	2
1172864	Check Valve - Mix In Line (Outer)	2
2177274	Clip - Retaining (Mix Probe To Cover)	2
2203792	Pick-Up Tube - Mix	2
3177229	Cover - Rear (Mix Container)	2
3177262	Cover - Front (Mix Container)	2



**DOMESTIC WARRANTY
(Including Mexico)**

1. **Scope:**

Stoelting, A Vollrath Company (“Stoelting”) warrants to the first user (the “Buyer”) that the Stoelting-branded freezer equipment (the “Equipment”) will be free from defects in materials and workmanship under normal use and proper maintenance for the period listed below in the Warranty Period section. All warranty periods begin on the date of original install or one (1) year from the shipping date, whichever occurs first. This warranty is subject to all conditions, exceptions, and limitations contained herein.

2. **Disclaimer of Other Warranties:**

THIS WARRANTY IS EXCLUSIVE; AND STOELTING HEREBY DISCLAIMS ANY IMPLIED WARRANTY OF MERCHANTABILITY OR FITNESS FOR PARTICULAR PURPOSE.

3. **Remedies:**

Stoelting’s sole obligations, and Buyer’s sole remedies, for any breach of this warranty shall be, at Stoelting’s option, one of the following: repair or replacement of the affected component at Stoelting’s plant in Kiel, Wisconsin, or refund of the purchase price of the affected Equipment. Stoelting, through an Authorized Stoelting Provider, will deinstall/reinstall the affected component from/into the equipment (“Labor”) for the period listed below in the Warranty Period section. These obligations/remedies are subject to the conditions that Buyer (a) signs and returns to Stoelting, upon installation, the Start-Up and Training Checklist for the affected equipment, (b) gives Stoelting prompt written notice of any claimed breach of warranty within the applicable warranty period, and (c) delivers the affected equipment to Stoelting or its designated service location, in its original packaging/crating, also within that period. Buyer shall bear the cost and risk of shipping to and from Stoelting’s plant or designated service location.

4. **Warranty Period:**

Equipment	Part	Part Warranty Period	Labor Warranty Period
Soft Serve & Shake	Freezing Cylinders	Five (5) Years	Twelve (12) Months
	Hoppers		
	Compressors		
	Drive Motors		
	Speed Reducers		
	Augers		
Frozen Uncarbonated Beverage	Evaporator	Five (5) Years	Twelve (12) Months
	Compressors		
	Drive Motors		
	Speed Reducers		
Custard & Batch	Freezing Cylinders	Two (2) Years	Twelve (12) Months
	Hoppers		
	Compressors		
	Drive Motors		
	Speed Reducers		
	Beaters		
Dipping Cabinets & Display Cabinets	All components	Twelve (12) Months	Twelve (12) Months
Frozen Beverage / Granita Dispenser	Compressors	Five (5) Years	Twelve (12) Months
	Electronic Board	Three (3) Years	
	All other components	Two (2) Years	
AutoVend	All components	Twelve (12) Months	Twelve (12) Months
Crème Whippers	Compressors	Two (2) Years	Twelve (12) Months
	Motors		
	Condensers		
All equipment	All other components not specified above	Twelve (12) Months	Twelve (12) Months



**DOMESTIC WARRANTY
(Including Mexico)**

5. Conditions:

- a) If the date of the original installation cannot be verified, these warranty periods begin one (1) year from the shipping date. It is the responsibility of the seller to disclose this information to the Buyer at the time of sale.
- b) Stoelting shall not be responsible to provide any remedy under this warranty with respect to any component that fails by reason of negligence, abnormal use, misuse or abuse, faulty repair made by others, use with parts or equipment not manufactured or supplied by Stoelting, any modification or alteration of any parts or equipment, or damage in transit.
- c) This warranty is valid only if the Equipment is installed and serviced by an Authorized Stoelting Provider and only if new, genuine Stoelting parts are used.
- d) The Equipment installation location must have suitable conditions as explained in the Stoelting operators manual, specification sheet, and/or technical manual including but not limited to, ambient temperature, water supply parameters, and space requirements.
- e) The Authorized Stoelting Provider must return defective parts, at Stoelting's discretion, for credit.
- f) Any refrigerant other than that specified on the Equipment model identification nameplate voids this warranty.

6. Exceptions:

This warranty does **NOT** cover any of the following:

- a) Costs associated with installation labor, disposal of equipment being replaced, and shipping costs of replacement parts or Equipment.
- b) Cleaning, maintenance or lubrication of the Equipment as outlined in the Stoelting operators manual.
- c) This warranty does not extend to parts, sometimes called "wear parts", which are generally expected to deteriorate and to require replacement as equipment is used, including, but limited to, o-rings, auger flights, auger seals, auger support bushings, and drive belts. All such parts are sold **AS IS**.
- d) External components including, but not limited to, hoses, piping, or electrical equipment.
- e) Labor and travel charges due to return trips or waiting if the Authorized Stoelting Provider is prevented from promptly starting service work upon arrival. This exception includes labor charges incurred for limited access facilities including, but not limited to, government and military buildings, and airports.
- f) Failure, damage, or repairs due to faulty installation, misapplication, abuse, lack of service, or improper service, unauthorized alteration, improper operation as indicated in the Stoelting operators manual, including, but not limited to, failure to properly assemble and/or clean, improper tool usage, or use of unapproved lubrication, or cleaning and sanitizing supplies.
- g) Any costs associated with electricity, including utility increases, from any reason whatsoever.
- h) Damage resulting from the use of refrigerant other than that specified on the Equipment model identification nameplate.
- i) The use of this equipment as a rental asset. Use as a rental asset negates all warranties associated with the equipment.
- j) Any special, indirect or consequential property or commercial damage of any nature whatsoever, if the jurisdiction allows this exclusion.
- k) Costs not covered by Stoelting's travel pay policy; Stoelting covers only the first trip travel which is a flat rate by mileage one-way from the service company's home location, or closest location to the job site. The flat rate is calculated as follows:
 - o 0-50 Miles \$85
 - o 51-110 Miles \$127
 - o 111-160 Miles \$165
 - o Over 160 Miles The maximum reimbursed by Stoelting is \$165

Any travel costs not covered may be invoiced to the customer.

7. Limitations:

THE REMEDIES SET FORTH IN THIS WARRANTY SHALL BE THE SOLE LIABILITY STOELTING AND THE EXCLUSIVE REMEDY OF BUYER WITH RESPECT TO EQUIPMENT SUPPLIED BY STOELTING; AND IN NO EVENT SHALL STOELTING BE LIABLE FOR ANY INCIDENTAL OR CONSEQUENTIAL DAMAGES, INCLUDING AS EXAMPLES BUT NOT INTENDED TO BE LIMITED TO DOWNTIME, OVERHEAD, MATERIALS, PERFORMANCE PENALTIES, LOST SALES, LOST PROFITS, PRODUCT LOSS, OR PROPERTY DAMAGES, WHETHER FOR BREACH OF WARRANTY OR OTHER CONTRACT BREACH, NEGLIGENCE OR OTHER TORT, OR ON ANY STRICT LIABILITY THEORY.

