

1. The motor must be connected to the three-phase supply.
 2. The motor must be connected to the three-phase supply.
 3. The motor must be connected to the three-phase supply.

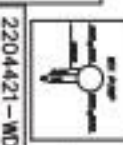

CAUTION
 DISCONNECT POWER SUPPLY
 BEFORE SERVICING

2204421 - WD

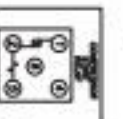
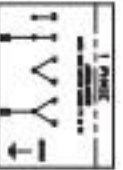
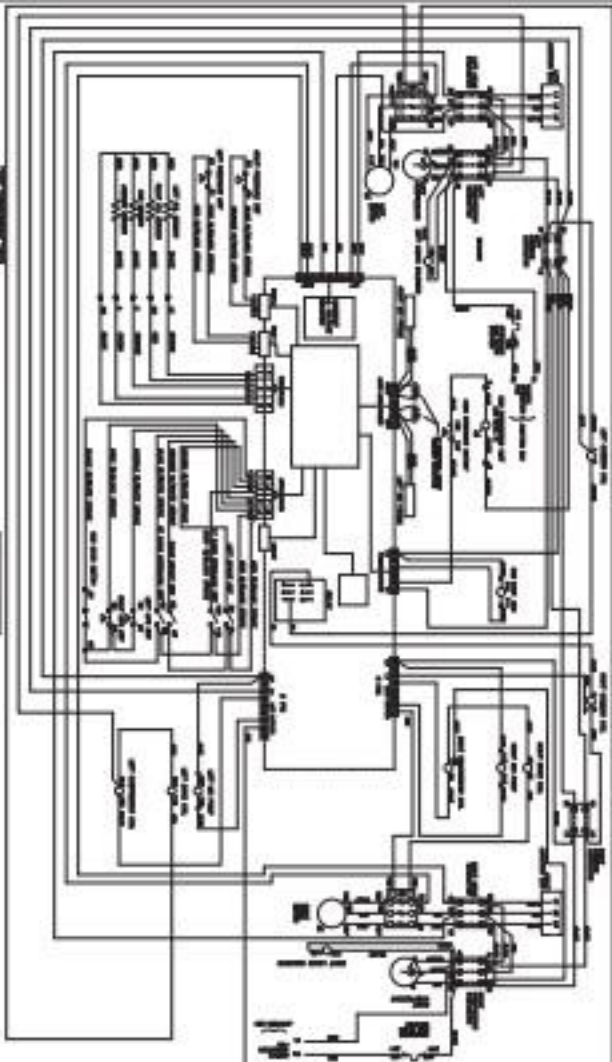

WIRE COLOR	WIRE NUMBER
BROWN	B-1
BLACK	B-2
RED	B-3
BLUE	B-4
GREEN	B-5
YELLOW	B-6
PINK	B-7
ORANGE	B-8
WHITE	B-9
GRAY	B-10
TEAL	B-11
SLATE	B-12
INDIAN RED	B-13
CRIMSON	B-14
MAUVE	B-15
ROSE	B-16
SAFFRON	B-17
AMBER	B-18
GOLD	B-19
BRONZE	B-20
COPPER	B-21
IRIDIUM	B-22
PLATINUM	B-23
PALLADIUM	B-24
RHODIUM	B-25
ROSE GOLD	B-26
WHITE GOLD	B-27
YELLOW GOLD	B-28
BLACK GOLD	B-29
RED GOLD	B-30
GREEN GOLD	B-31
BLUE GOLD	B-32
PURPLE GOLD	B-33
BROWN GOLD	B-34
ORANGE GOLD	B-35
PINK GOLD	B-36
TEAL GOLD	B-37
SLATE GOLD	B-38
INDIAN RED GOLD	B-39
CRIMSON GOLD	B-40
MAUVE GOLD	B-41
ROSE GOLD	B-42
SAFFRON GOLD	B-43
AMBER GOLD	B-44
GOLD	B-45
BRONZE	B-46
COPPER	B-47
IRIDIUM	B-48
PLATINUM	B-49
PALLADIUM	B-50
RHODIUM	B-51
ROSE GOLD	B-52
WHITE GOLD	B-53
YELLOW GOLD	B-54
BLACK GOLD	B-55
RED GOLD	B-56
GREEN GOLD	B-57
BLUE GOLD	B-58
PURPLE GOLD	B-59
BROWN GOLD	B-60
ORANGE GOLD	B-61
PINK GOLD	B-62
TEAL GOLD	B-63
SLATE GOLD	B-64
INDIAN RED GOLD	B-65
CRIMSON GOLD	B-66
MAUVE GOLD	B-67
ROSE GOLD	B-68
SAFFRON GOLD	B-69
AMBER GOLD	B-70
GOLD	B-71
BRONZE	B-72
COPPER	B-73
IRIDIUM	B-74
PLATINUM	B-75
PALLADIUM	B-76
RHODIUM	B-77
ROSE GOLD	B-78
WHITE GOLD	B-79
YELLOW GOLD	B-80
BLACK GOLD	B-81
RED GOLD	B-82
GREEN GOLD	B-83
BLUE GOLD	B-84
PURPLE GOLD	B-85
BROWN GOLD	B-86
ORANGE GOLD	B-87
PINK GOLD	B-88
TEAL GOLD	B-89
SLATE GOLD	B-90
INDIAN RED GOLD	B-91
CRIMSON GOLD	B-92
MAUVE GOLD	B-93
ROSE GOLD	B-94
SAFFRON GOLD	B-95
AMBER GOLD	B-96
GOLD	B-97
BRONZE	B-98
COPPER	B-99
IRIDIUM	B-100



220373B-MO

CAUTION
 DISCONNECT POWER SAFELY
 BEFORE REPAIRS

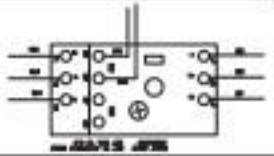
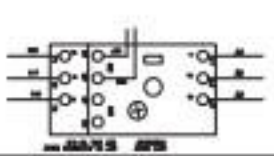

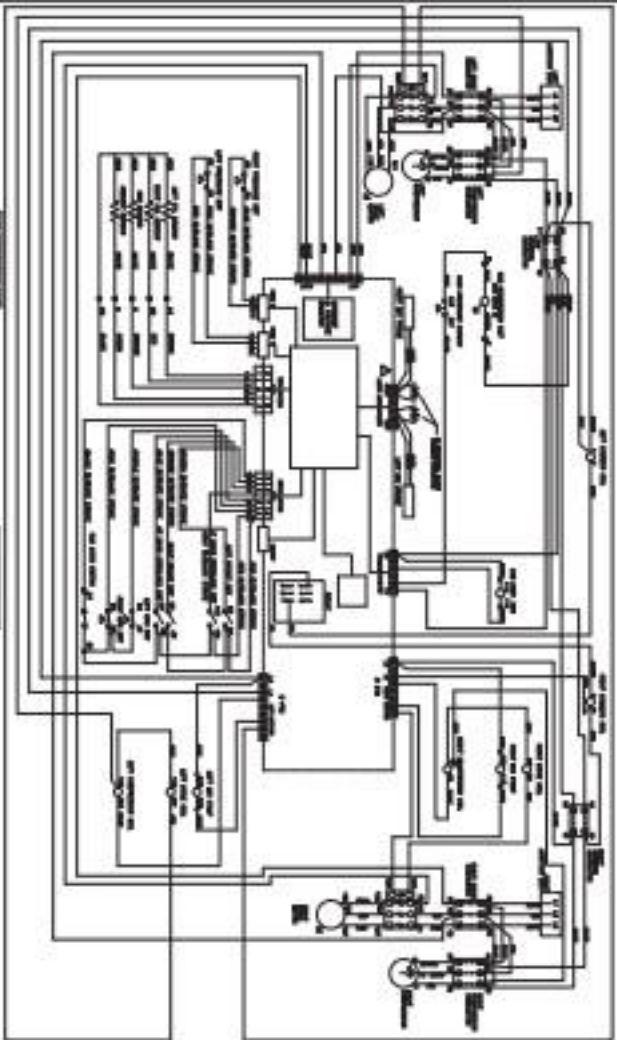

Wiring Diagram
 1965-1966
 1967-1968
 1969-1970
 1971-1972
 1973-1974
 1975-1976
 1977-1978
 1979-1980
 1981-1982
 1983-1984
 1985-1986
 1987-1988
 1989-1990
 1991-1992
 1993-1994
 1995-1996
 1997-1998
 1999-2000
 2001-2002
 2003-2004
 2005-2006
 2007-2008
 2009-2010
 2011-2012
 2013-2014
 2015-2016
 2017-2018
 2019-2020
 2021-2022
 2023-2024
 2025-2026
 2027-2028
 2029-2030
 2031-2032
 2033-2034
 2035-2036
 2037-2038
 2039-2040
 2041-2042
 2043-2044
 2045-2046
 2047-2048
 2049-2050

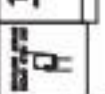

22039668 - WD

CAUTION
 DISCONNECT BATTERY
 BEFORE SERVICE

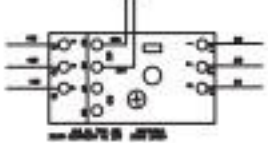
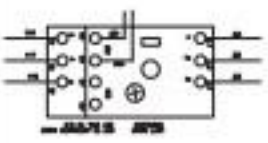

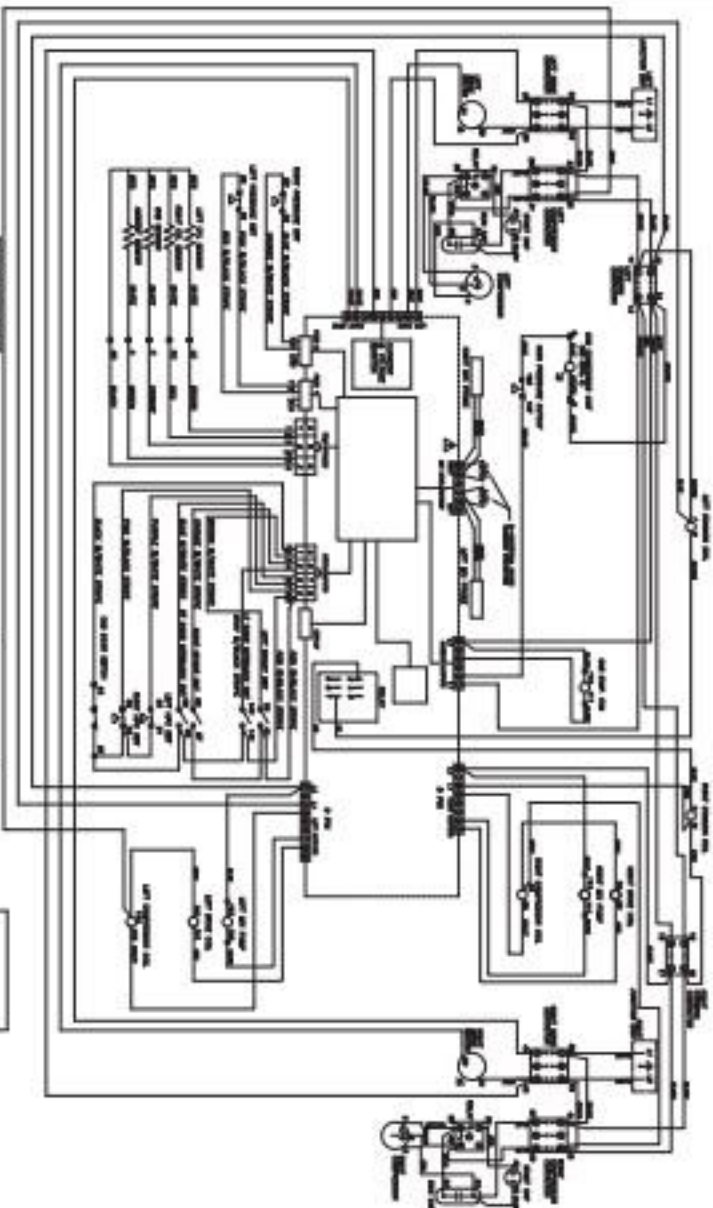

WIRING DIAGRAM
 This diagram shows the electrical system for the vehicle. It includes the battery, fuse block, and various electrical components. The diagram is intended for use by a qualified technician.

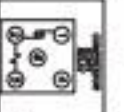

CAUTION
 Disconnect power supply before servicing.

2203567-WD

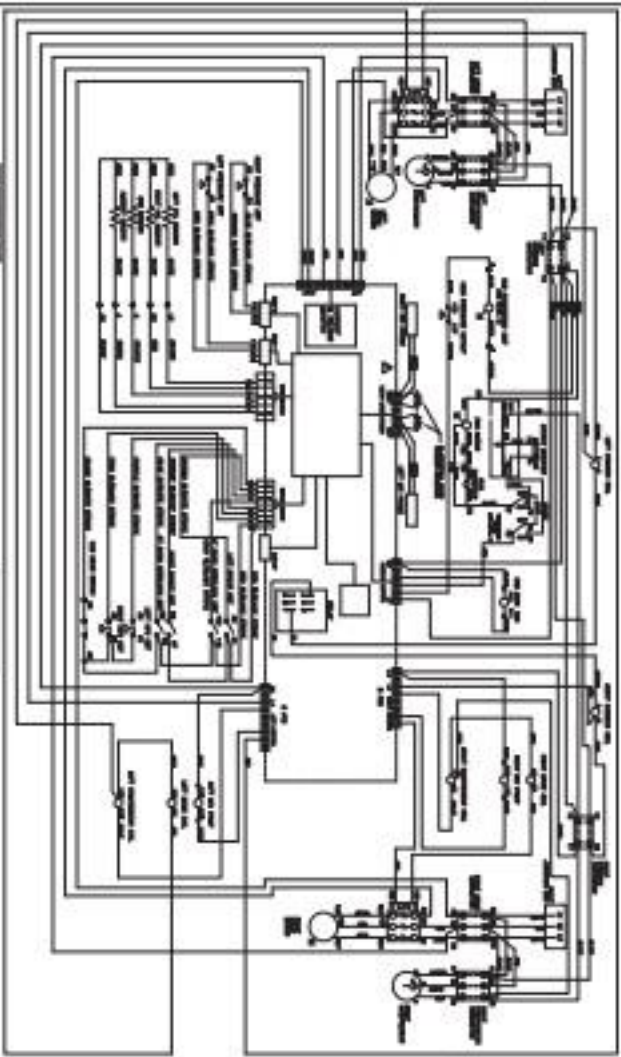

Wiring Diagram
 2203435-WO

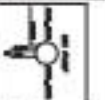

2203435-WO

CAUTION
 CONSULT FORD SERVICE
 REPAIR MANUAL

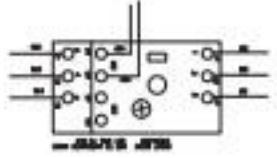
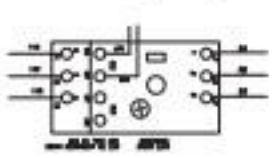

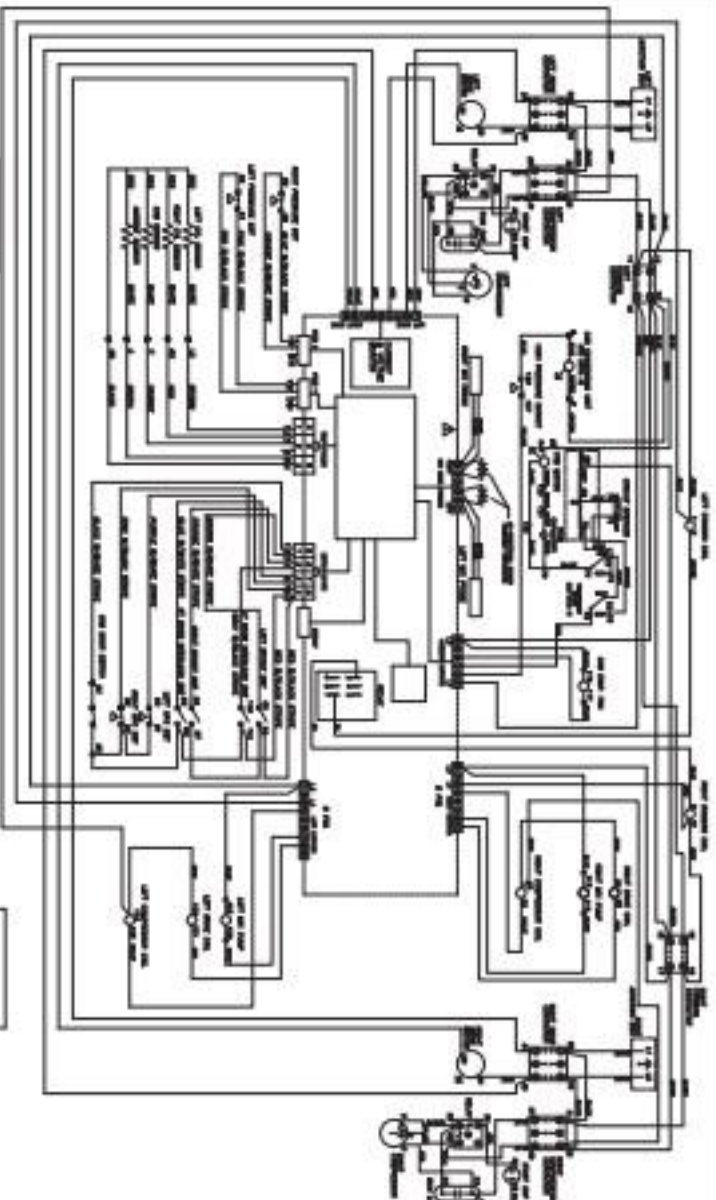

WIRE COLOR KEY
 BATTERY
 IGNITION
 HEADLIGHTS
 TAIL LIGHTS
 WINDSHIELD WIPER MOTOR
 HORN
 FUEL PUMP
 WATER PUMP
 FAN MOTOR
 BLOWER MOTOR
 RELAY
 SWITCH
 FUSE

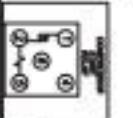
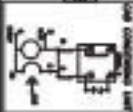

2203433-WD
CAUTION
 DISCONNECT BATTERY BEFORE SERVICING

Cabinet Refrigeration R134A

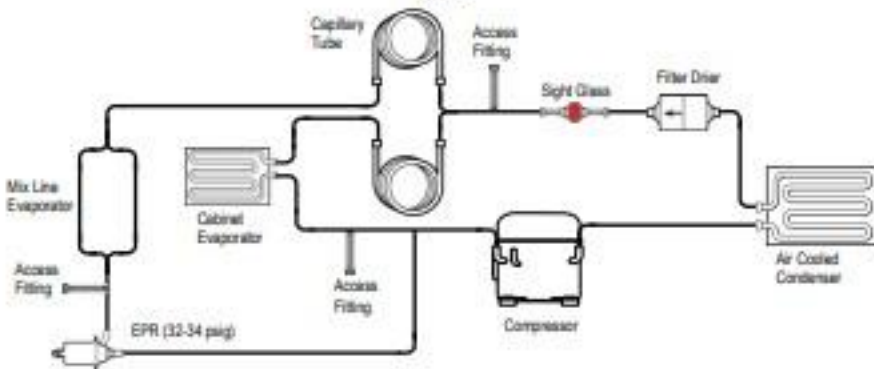

Left Side R404A

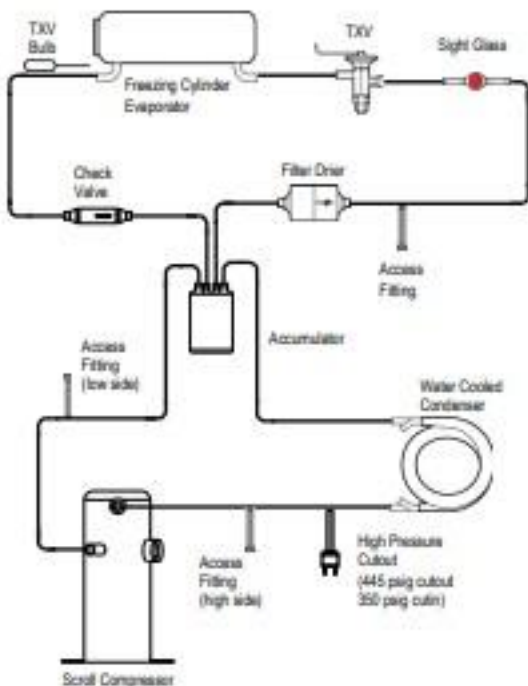

Right Side R404A

