

# Technical Manual and Replacement Parts List

---

## Beverage Dispenser



MODEL SKBD120P

**SILVER KING REFRIGERATION INC.**

1600 Xenium Lane North, Minneapolis, MN 55441-3787  
Phone (763) 923-2441

**SILVER KING**®

Specifications Subject to Change Without Notice.



**TECHNICAL MANUAL**  
**MODEL SKBD120P CREAM DISPENSER**  
**INSTALLATION, OPERATION AND MAINTENANCE**

Thank you for purchasing Silver King food service equipment. Our goal is to provide our customers with the most reliable equipment in the industry today. Please read this manual and the accompanying warranty information before operating your new Silver King unit. Be sure to complete and mail the warranty card within 10 days of purchase to validate your warranty.

Upon delivery of your new Silver King unit, inspect the carton and unit for shipping damages. Report any damage immediately to the transportation carrier and file a written freight damage claim to protect your investment. If a claim is to be filed, save all packaging materials.

**INSTALLATION**

The stainless steel exterior of the cabinet has been protected by a plastic covering during manufacturing and shipping. This covering can be readily peeled before installation. After removing this covering, wash the interior and exterior surfaces using a warm mild soapy water solution and a sponge or cloth, rinse with clean water and wipe dry.

**Location:**

When locating your cream dispenser, convenience and accessibility are important considerations, but the following factors must be observed:

- When placing the unit on a counter, the counter must be able to support a minimum of 100 pounds.
- When placed on a counter, the unit must be on the feet supplied. If the feet are removed the unit will not operate properly and the warranty will be void.
- There must be at least two inches of clear space above, on the sides and behind the unit and open in front.
- Correct serving height is important so that those using the dispenser can operate the dispenser properly.
- The unit must be level. The feet are adjustable to aid in leveling the unit.
- Avoid placing the unit next to an oven, heating element or hot air source which would affect the performance of the unit.

**Electrical Connections:**

Be sure to check the data plate, located on the liner of the cabinet, for required voltage prior to connecting the unit to power. The specifications on the data plate supersede any future discussion.

The standard dispenser is equipped with an seven (7) foot power cord that requires a 115 Volt, 60 Cycle, 1 Phase or 230 Volt, 50 Cycle, 1 Phase properly grounded electrical receptacle (please check the serial plate for voltage information). The power cord comes with a 3 prong plug for grounding purposes. Any attempt to cut off the grounding spike or to connect to an ungrounded adapter plug will void the warranty, terminate the manufacturer's responsibility and could result in serious injury.

## Operation

### Initial Startup

After satisfying the installation requirements, the cream dispenser is ready to start. The unit will start when the power cord is connected to a live electrical receptacle. This can be verified by checking the indicator panel on the front of the unit. The indicator should display the current unit temperature. If the unit does not start when the power cord is plugged in, make sure that the switch on the back of the unit is in the 'on' position. Allow the unit to run a minimum of two hours before loading it with product. **It is completely normal for the exterior of the unit to feel warm while it is running.**

### Indicator Panel

The Indicator Panel contains a digital LED display that reads the product temperature during normal operation. The three lower buttons on the Indicator Panel are for selecting portion sizes (small or large). The upper button is used to reset the computer whenever the cream is refilled. **This button must be pressed each time the cream is refilled. Press and hold the REFILL button for 3 seconds until the indicator flashes 00.**

### Preparation for Use

Once the unit has achieved proper operating temperature, observe the procedures noted in the label on the door liner for loading cream into the cream dispenser. When removing an empty bag of cream, be sure to push the Valve Slide in fully before pulling the Dispensing Tube out of the valve. It may be easier to remove or install the Dispensing Tube in the valve by removing the Valve Insert first then removing or installing the Cream Container. The end of the tube may need to be cleaned daily with a clean cloth to prevent buildup which could affect the dispensing of product. **After loading the creamer, press and hold the REFILL button for 3 seconds until the indicator flashes 00.**

### Defrost:

The Silver King cream dispenser is a manual defrost unit. The unit should be defrosted whenever the walls accumulate a frost bank that is 1/2 inch thick. To defrost the unit, either turn the Temperature Control knob to the 'off' position or disconnect the power cord from the electrical receptacle, and open the door. After the frost has melted or come loose from the cabinet walls, wipe out the cabinet interior. Do not attempt to scrape or chisel off the frost as you could do irreparable damage to the unit.

### MAINTENANCE

Preventative maintenance is minimal although these few steps are very important to continued operation and maximizing the life of the appliance.

### Cabinet Surfaces:

The cabinet interior and exterior are stainless steel and should be cleaned periodically with a solution of warm water and a mild soap, rinsed and wiped dry with a clean soft cloth. A stainless steel cleaner can also be used. Should a surface become stained or discolored, do not attempt to clean with an abrasive cleaner or scouring pad. Use a soft cleaner and rub with the grain of the metal to avoid scratching the surface. Do not use chlorinated cleaners.

### Valve Assembly:

To dis-assemble the valve for cleaning, with the door open, pull the release latch on the top of the Valve Assembly. The Valve Assembly will then swivel forward and then slide up and out at an angle. Clean the Valve Assembly with a solution of mild soap and warm water or in a dishwasher. Rinse, dry and re-assemble. The Valve Body must be cleaned in place as it is not readily removable.

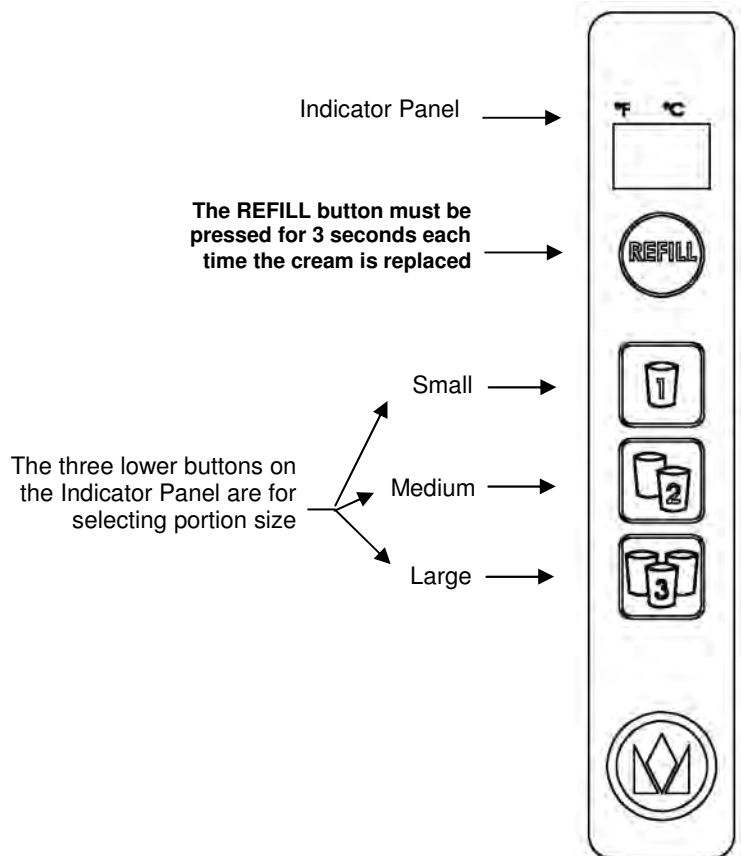

## CREAM BAG REFILLING INSTRUCTIONS

**STEP 1** PUSH IN VALVE SLIDE,  
REMOVE BLACK  
VALVE INSERT

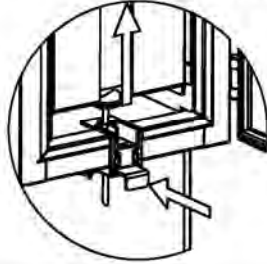

**STEP 2** REMOVE CRATE,  
DISCARD EMPTY  
PRODUCT BAG

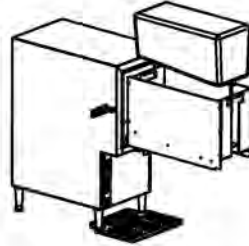

**STEP 3** INSTALL NEW  
PRODUCT IN  
CRATE

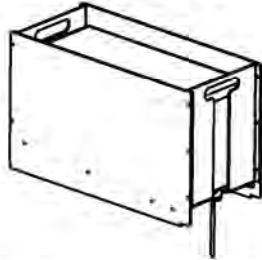

**STEP 4** REPLACE CRATE  
IN UNIT

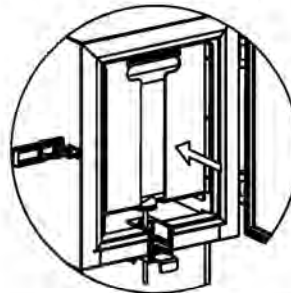

**STEP 5** REPLACE BLACK  
VALVE INSERT

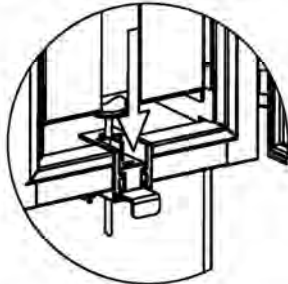

**STEP 6** PRESS & HOLD  
REFILL BUTTON UNTIL  
DISPLAY READS "00"

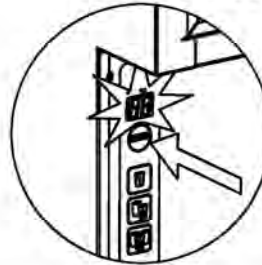

**STEP 7** CUT TUBE 1" BELOW  
VALVE AT ANGLE  
FRONT TO BACK

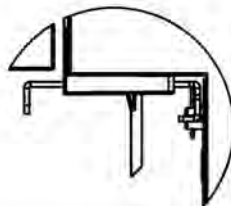

33470

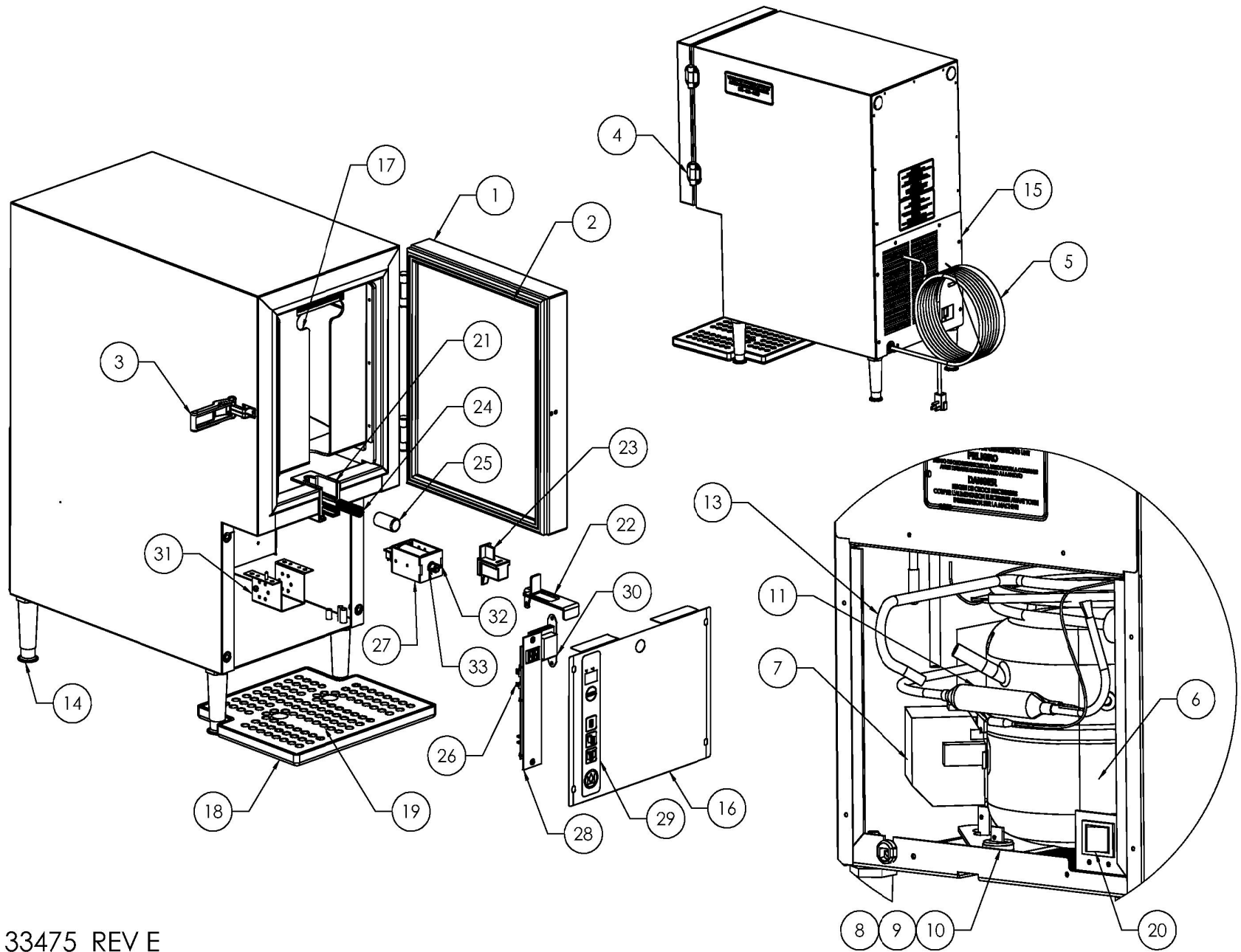

33475 REV E

## REPLACEMENT PARTS LIST SKBD120P

| ITEM NO. | PART DESCRIPTION                          | PART NUMBER |
|----------|---|-------------|
| 1        | DOOR ASSEMBLY (LESS HINGES)               | 31359       |
| 2        | DOOR GASKET                               | 10310-62    |
| 3        | LATCH                                     | 25227       |
| 4        | HINGE                                     | 25226       |
| 5        | POWER CORD 115V                           | 22099       |
| 6        | COMPRESSOR KIT 115V                       | 10343-51    |
| 7        | ELECTRICALS KIT (RELAY AND OVERLOAD) 115V | 10344-51    |
| 8        | GROMMET, COMPRESSOR MOUNT                 | 20481       |
| 9        | HAIRPIN CLIP                              | 98106       |
| 10       | WASHER, COMPRESSOR MOUNT                  | 22401       |
| 11       | DRIER                                     | 22677       |
| 13       | HEAT EXCHANGER                            | 30876       |
| 14       | LEGS, 4 INCH                              | 10314-61    |
| 15       | BACK PANEL                                | 33473       |
| 16       | APRON ASSEMBLY                            | 33440       |
| 17       | MILK CRATE                                | 33442       |
| 18       | DRIP TRAY                                 | 32590       |
| 19       | DRIP TRAY COVER                           | 32591       |
| 20       | SWITCH ROCKER                             | 26378       |
| 21       | VALVE BODY                                | 31942       |
| 22       | VALVE SLIDE                               | 33369       |
| 23       | VALVE INSERT                              | 31944       |
| 24       | VALVE SPRING                              | 27019       |
| 25       | CAP SLEEVE                                | 33726       |
| 26       | THERMISTOR                                | 26155       |
| 27       | SOLENOID 115V                             | 27696       |
| 28       | ELECTRONIC BOARD (3-BUTTON) W/ THERMISTOR | 32131       |
| 29       | MEMBRANE SWITCH (3-BUTTON)                | 32034       |
| 30       | ASSY TRANSFORMER 115V                     | 26039       |
| 31       | BRACKET SOLENOID                          | 33366       |
| 32       | PIN COTTER                                | 25989       |
| 33       | PLUNGER                                   | 34877       |

WHEN ORDERING REPLACEMENT PARTS, PLEASE PROVIDE MODEL AND SERIAL

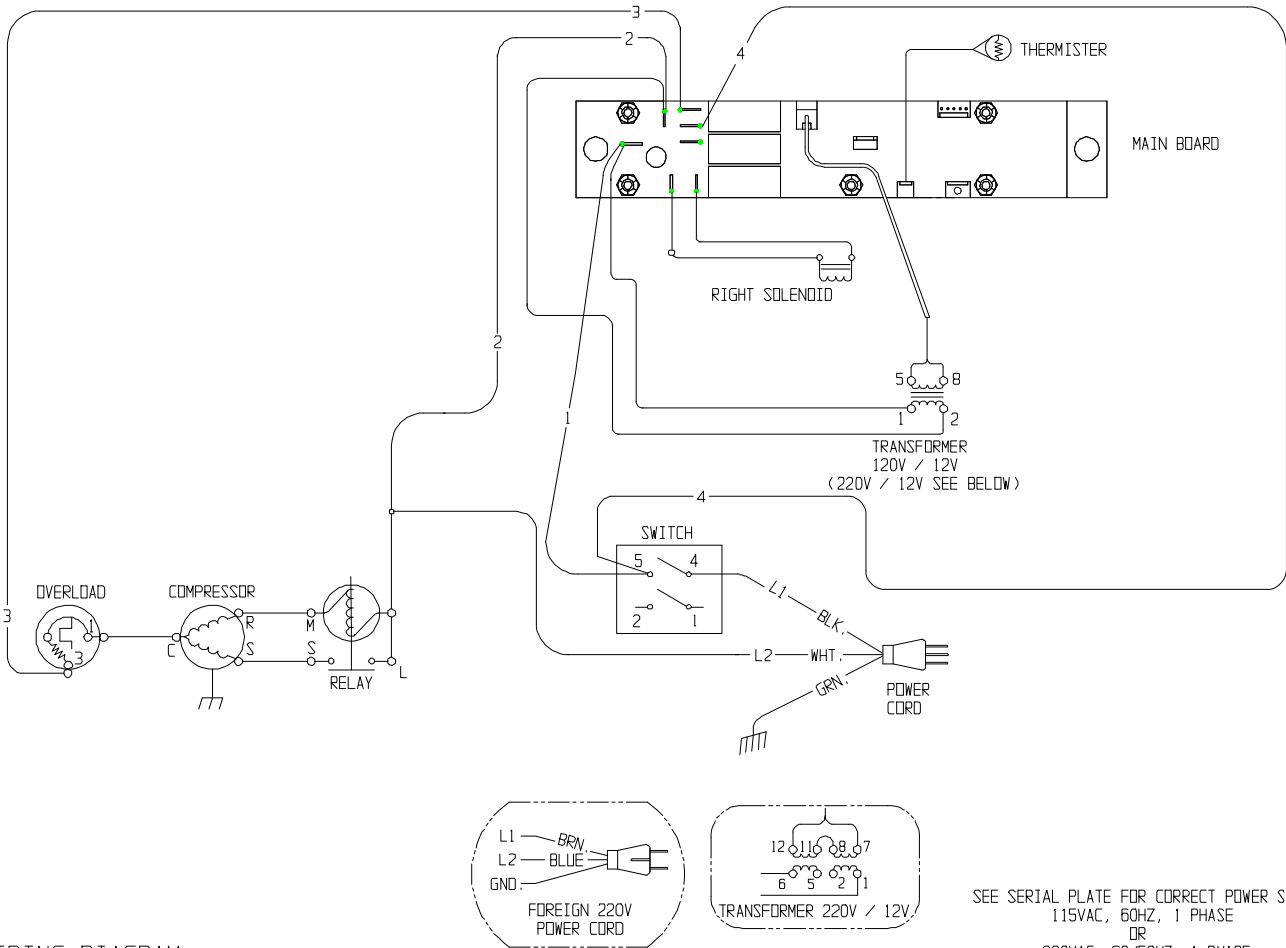

WIRING DIAGRAM  
 MODELS SKCRM1P, SKCRM2P, SKMCD1P

25993 REV D

SEE SERIAL PLATE FOR CORRECT POWER SOURCE  
 115VAC, 60HZ, 1 PHASE  
 OR  
 220VAC, 60/50HZ, 1 PHASE

Model \_\_\_\_\_ Serial No. \_\_\_\_\_ Date Installed \_\_\_\_\_

FORM NO. 33474 REV E