

## HOT FOOD DISPLAY

### Operation Manual

Models:

HFD000006, 7

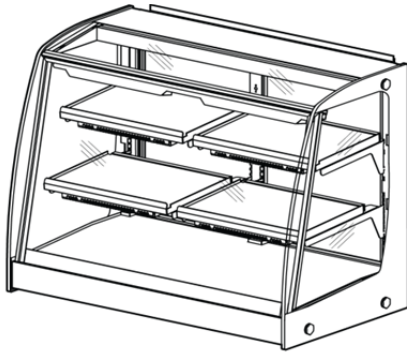

HFDM00002



HFDC00003

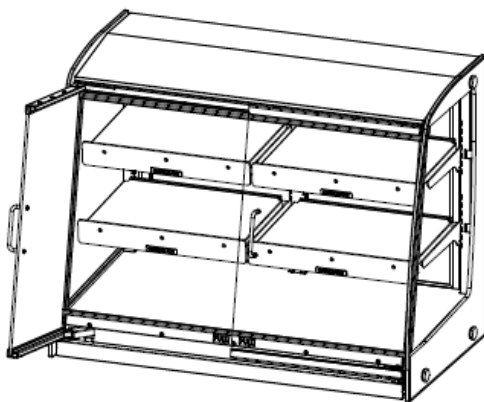

### Table of Contents

Commitment to Safety.....	2
Safety Warnings.....	3
Installation Requirements.....	5
Product Summary and Accessories.....	6
Operation.....	7
Troubleshooting.....	8
Cleaning, Pan Stops, Rear Door Lock...9	
Optional Bag & Tong Holder, Top Shelf, Sign Holder Installation and POP Kit...11	

HFDH00003, HFDHC0009, HFDHC0010

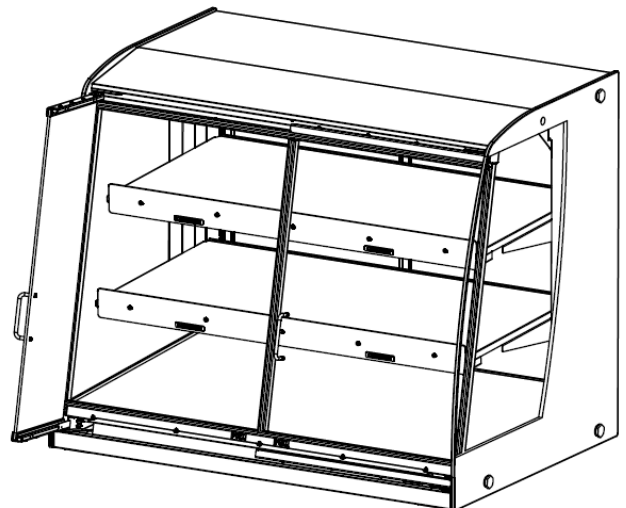

## A COMMITMENT TO SAFETY

The SandenVendo is committed to safety in every aspect of our product design. SandenVendo is committed to alerting every user to the possible dangers involved in improper handling or maintenance of our equipment. The servicing of any electrical or mechanical device involves potential hazards, both to those servicing the equipment and to users of the equipment. These hazards can arise because of improper maintenance techniques. The purpose of this manual is to alert everyone servicing SandenVendo equipment of potentially hazardous areas, and to provide basic safety guidelines for proper maintenance.

This manual contains various warnings that should be read and carefully followed to minimize the risk of personal injury to service personnel. This manual also contains service information to insure that proper methods are followed to avoid damaging the Hot Food Display (HFD) or making it unsafe. It is also important to understand these warnings are not exhaustive. SandenVendo could not possibly know, evaluate, or advise of all of the conceivable ways in which service might be done, nor can SandenVendo predict all of the possible hazardous results. The safety precautions outlined in this manual provide the basis for an effective safety program. Use these precautions, along with the service manual, when installing or servicing the HFD.

We strongly recommend a similar commitment to safety by every servicing organization. Only properly trained personnel should have access to the interior of the machine. This will minimize the potential hazards that are inherent in electrical and mechanical devices. SandenVendo has no control over the machine once it leaves the premises. It is the owner or lessor's responsibility to maintain the Hot Food Display in a safe condition. Follow all Safety Warnings and Installation Requirements in this manual. Refer to the Technical Service Manual for recommended maintenance procedures. If you have any questions, please contact the Technical Services Department of SandenVendo at 800-344-7216.

## FOOD FOR THE HOT FOOD DISPLAY

The HFD, HFDM, and HFDH units are design to hold unwrapped, wrapped, and boxed food. The HFDHC is designed to hold wrapped and boxed food. Hot food displays are not designed to heat cold food - put only hot food in the hot food display.

# Vendo SANDEN SANDENVENDO AMERICA INC

## SAFETY WARNINGS

The HFD is for indoor use only. Do not use near water or in condensing humidity.

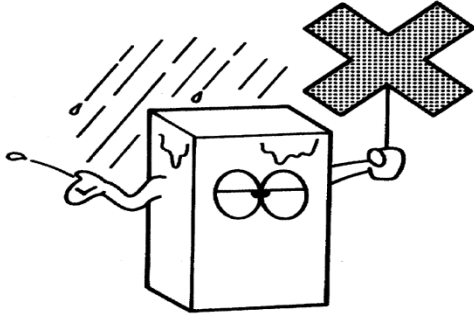

When unplugging, first turn off the power switch. Then pull the plug at the end of the power cord, not by pulling the power cord, since the cord can be damaged, overheat, and cause a fire.



Do not spray water on the HFD. It may cause an electric shock or fire.



To prevent electric shock or fire, do not kink, pull, or pinch the power cord, and insure no equipment is resting on the power cord. If the power cord is damaged, unplug and replace.



Do not touch the power plug, switches, or other electrical parts with wet hands. It can cause an electric shock.



Do not connect with other plugs. Do not use an extension cord.

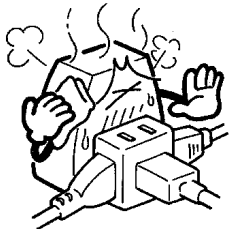

Periodically check that the plug is pushed in all the way.



**Vendo**  
SANDEN **SANDENVENDO AMERICA INC**  
**SAFETY WARNINGS (continued)**

To prevent injuries due to falling objects, liquid spills, electric shock or fire, do not place heavy objects or liquid-filled objects on top of the HFD.



To prevent electric shock or fire, do not use volatile or flammable products in or near the HFD.



When moving the HFD: turn the HFD off, unplug, and allow the unit to cool. To prevent glass breakage and injury, do not push on the glass. Also, use proper equipment and lifting techniques. Insure the product doesn't tip while it is being moved.



If a lamp or any glass cracks or breaks, turn off the power and discard all food in the HFD. Replace lamp and / or glass. Remove all glass fragments. Carefully inspect all surfaces, corners, and gaskets to insure all glass fragments have been removed before returning HFD to service.

Use only authorized replacement parts.

Don't place food directly on the hot plates.

Keep HFD out of direct sunlight and away from heat sources.

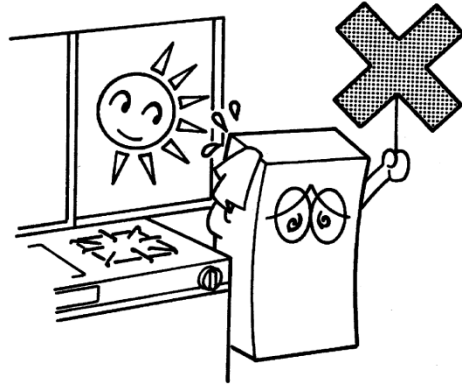

Do not hang from the door – this may cause injury or electric shock.

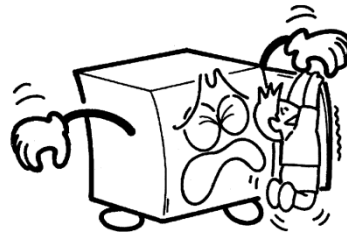

To prevent injury, do not allow children to climb on or play on the HFD.



Turn off and unplug HFD before servicing, and let HFD cool before cleaning or servicing.



Use proper tools while servicing.

If the HFD malfunctions, turn it off and unplug it. Have the HFD serviced by qualified personnel.

The HFD temperatures are factory set to meet NSF food safety requirements. Changing temperature settings may adversely impact food safety.

The lamps are an integral part of the food heating system. If a lamp is not illuminated, the temperatures may not be maintained for

food safety. Therefore, replace nonworking lamps.

## INSTALLATION REQUIREMENTS

The HFD must be connected to a dedicated 115V 15A (or greater) grounded circuit. Test for proper grounding and polarization before installing to reduce the risk of electrical shock and fire.

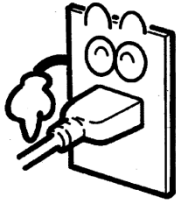

Keep the HFD four inches away from walls and other products to prevent abnormal heating.

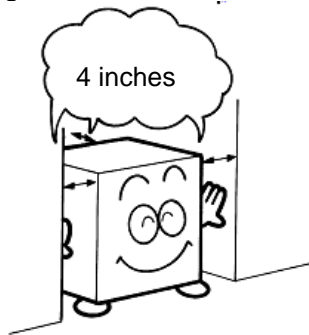

Install the HFD on a strong, level surface to prevent it from tipping or falling.

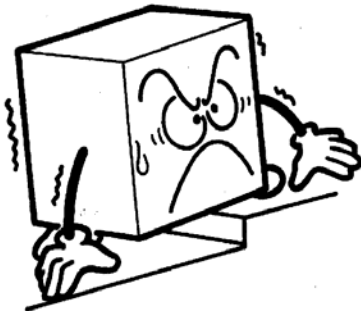

The HFDC front doors are aligned at the factory. When the HFDC is uncrated and placed on a counter, the front doors (from movement during shipping or due to a counter that isn't completely flat) may be misaligned.

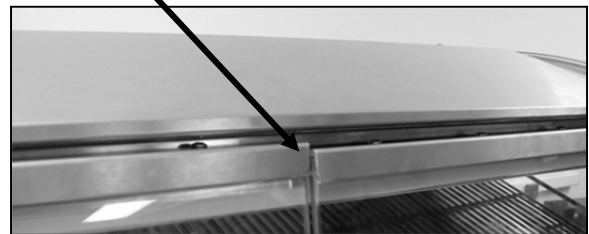

To align the front doors: (1) loosen the top bolts for the side glass (HFDC: once each side, HFDHC two each side). HFDC shown:

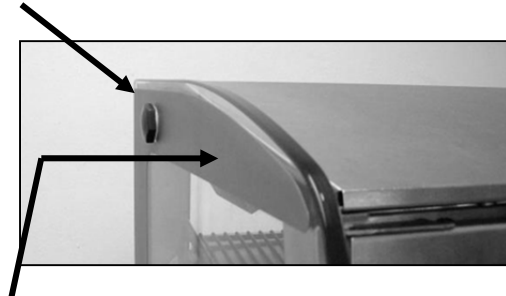

Push on the top of the side glass to align the doors. While holding the HFDC in this position, retighten the upper glass bolts. (This shows the left door higher than the right door. If the right door is higher, mirror this procedure.)

(2) If the doors are still misaligned, place one or more spacers (each about the thickness of a coin) under the front leveling foot nearest the front door that's low.



# SANDENVENDO AMERICA INC

## PRODUCT SUMMARY

Hot Food Display name	HFD	Combo Serve HFD	Mini HFD	High Capacity HFD
Model	HFD000006, 7	HFDC00003	HFDM00002	HFDH00003 HFDHC0009 HFDHC0010
Approximate Internal Volume cubic feet (liters)	6 ft <sup>3</sup> (170 liter)	6 ft <sup>3</sup> (170 liter)	4.1 ft <sup>3</sup> (116 liter)	14 ft <sup>3</sup> (396 liter)
External Dimensions W x D x H inches (mm)	35.3 x 19.7 x 27.6 (896 x 500 x 700)	35.3 x 19.7 x 27.6 (896 x 500 x 700)	24.9 x 19.7 x 27.6 (632 x 500 x 700)	42.7 x 29.8 x 35.1 (1085 x 757 x 892)
Approximate Weight	154 lbs. (70 kg)	160 lbs. (70 kg)	122 lbs. (55 kg)	276 lbs. (125 kg)
Temperature controlled heater plates	6 x 141 Watt	6 x 141 Watt	4 x 141 Watt	4 x 200 Watt (Middle & Top) 2 x 300 Watt (Bottom)
Lamps (for heating and illumination)	Six 40W Xenon	Six 40W Xenon	Three 40W Xenon	Six 40W Xenon
Glass	ANSI Standard Z97.1 Tempered			
Controller	Six temperature controls, 100°F - 255°F	Six temperature controls, 100°F - 255°F	Four temperature controls, 100°F - 255°F	Six temperature controls, 100°F - 270°F
Timers	12 Timers, settable from 30 minutes to 4 hours			
Power	115VAC, 60Hz, 9.5 amp	115VAC, 60Hz, 9.5 amp	115VAC, 60Hz, 6.0 amp	115VAC, 60Hz, 14.7 amp
Dual Circulation Fans	Model 7 only	Standard	Standard	Standard
Accessories	Rectangular Trays Round Pans	(none)	(none)	(none)
Safety Approvals: UL 197, CSA C22.2 No. 109-M81	UL File # E314888	UL File # E314888	UL File # E314888	UL File # E314888
Sanitation Approval: NSF / ANSI 4	UL File # E314889 (for HFD000001, 2, 3) NSF Listing Serial # D052450 (for HFD000004, 5, 6, 7)	NSF Listing Serial # D052450	NSF Listing Serial # D052450	NSF Listing Serial # D052450

## OPERATION

### Display and Keypad

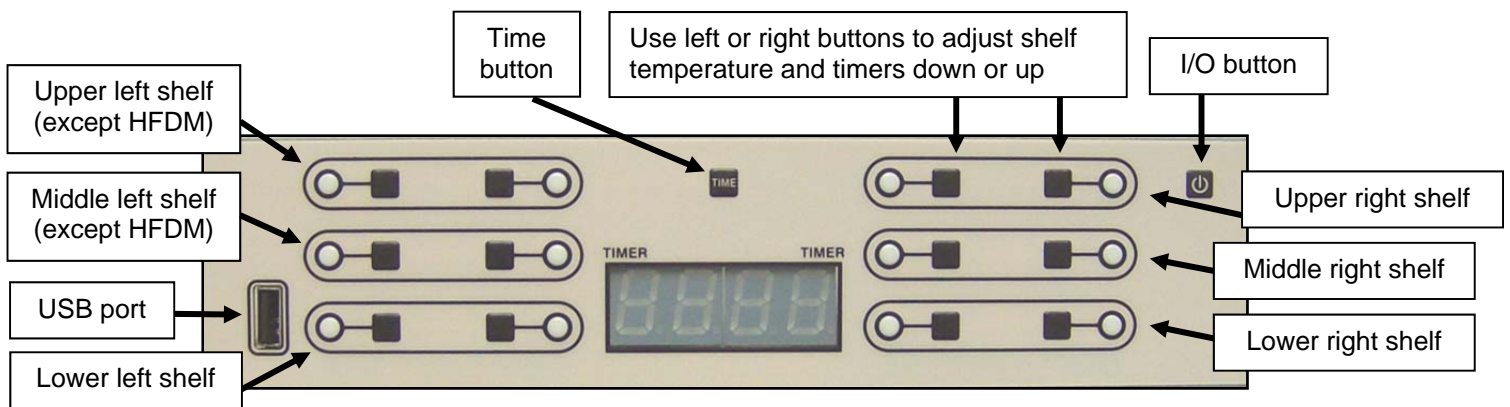

### Timer Setting and Operation

Note: to help prevent keypad damage, push keypad buttons only with finger or thumb; do not use fingernail, utensil, tool, pen, or other object.

Circulation fans may be turned on or off by the switch at the top rear of the HFD (HFD 7 and HFDC).

#### Normal Operation

Pressing the I/O button turns the HFD on or off. When controller is off, all lamps, heaters, displays and indicators are off. Front on/off button (HFDC only): press and hold for 5 seconds to turn the HFDC on or off.

#### Temperature Display On / Off

To turn the ambient temperature display on or off: with the controller on, press and hold the Time button and press the I/O button. Note: firmware revision 4.01 and later disables this feature.

#### Timers

When a timer is off, pressing the timer button once sets the countdown timer to the value preprogrammed into the controller.

Pressing the timer button again within three seconds (while the indicator next to the button is blinking) sets the timer to 30 minutes.

Each successive press (within three seconds) adds 30 minutes to the time, up to 4 hours.

At 4 hours, the next button press cycles the timer back to 30 minutes again.

Once the timer is activated, the LED next to the shelf timer button becomes green.

The display then reverts to HFD internal ambient temperature display.

While a timer is on, pressing a timer button once displays the remaining time for 4 seconds, then shelf temperature for 4 seconds, and then the display reverts to the internal ambient temperature display.

At 15 minutes remaining time, the LED turns yellow.

When no time remains, the LED turns red, plus an audible alarm sounds.

Pressing the timer button next to the blinking red LED clears the alarm and restarts the timer.

Holding down the Time button, then pressing a timer key, turns off the timer.

#### Converting Temperature from °F to °C (or °C to °F)

With controller power off, hold down the Time button, then press and hold the I/O button until the display comes on. The display will show the firmware revision.

Press and release the TIME button to change from °F to °C (or °C to °F).

Push the I/O button to turn on the HFD and lock in this setting.

## Front Door

If the front door is opened (HFD 6 and 7 only), the controller turns off only the lights. The display reads "OPEn". After closing the front door, the lights turn on, and the display reverts to internal ambient temperature.

## Error Codes

E30	Internal ambient thermistor open circuit		
E60	Upper left shelf thermistor open circuit (except HFDM)		
E61	Middle left shelf thermistor open circuit (except HFDM)		
E62	Lower left shelf thermistor open circuit		
E63	Upper right shelf thermistor open circuit		
E64	Middle right shelf thermistor open circuit		
E65	Lower right shelf thermistor open circuit		
E90	Unable to read USB drive (check for CFG file format error)		
E70	Upper left shelf not heating (except HFDM)	E73	Upper right shelf not heating
E71	Middle left shelf not heating (except HFDM)	E74	Middle right shelf not heating
E72	Lower left shelf not heating	E75	Lower right shelf not heating

Clear the error by powering off the HFD, correcting the problem, and turning the HFD on again.

## Programming using USB drive

With the HFD off:

1. Insert the flash drive in the controller's USB port.
2. Turn on the controller. The configuration will load in less than 5 seconds.
3. The display will show the configuration code (example: 001h) from the vendo.cfg file.
4. Pull the flash drive out of the controller (controller may remain on).

## Circulation Fans

Models HFD000007 and HFDC00002 include a low volume dual air circulation fan system. These fans are intended to improve internal temperature consistency and help reduce condensation inside the HFD. Located at the top of the back side of the HFD cabinet is a fan switch that controls the operation of the fan system. It is recommended that the fans remain "ON" at all times. However, through product testing, it may have been determined that specific products may require the fans to be turned off. Before turning the fans off, please consult your Food Quality Manger to determine if you are holding any food products that would require the fans to be turned off.

# TROUBLESHOOTING

If the HFD does not come on:

1. Check that the HFD is plugged in.
2. Check that the electrical outlet has power.

If the HFD does not heat up to the normal temperatures or is not heating properly:

Check for flashing red indicators on the controller and for error codes on the display. Press the button next to the flashing indicator, and note the error code (example E65, see error code list above). Turn the controller off, then on, to see if the error is cleared. If the error is not cleared, or periodically reappears, go to [www.vendoco.com](http://www.vendoco.com), Products, Hot Food Displays to the "Universal HFD Line Technical Service Manual", or contact Technical Service at the number on page 2.

## **CLEANING**

Prior to cleaning, insure the HFD is off, and allow the HFD to cool.

Keep HFD clean for optimal performance. Do not place dirty pans on hot plate surfaces. Clean pans thoroughly prior to placing food on pans, or use paper liner on pans. Keep area around unit clean and clear.

Do not use abrasive materials on hot plates or glass. Use only mild soap and water or nonabrasive cleaners with a soft cloth or sponge, then wipe dry.

To remove the rear sliding doors (HFD only): by lift the door up from bottom track and pull bottom of door out. Installation is reverse.

Remove the rear sliding door tracks by lifting at one edge. Tracks are flexible for ease of installation and removal. Clean food particles from door tracks. Clean surface under door tracks also.

Once the rear doors are removed, clean inside the HFD. Wipe off any food particles from all shelves, gaskets and glass.

Clean glass and gaskets around door assembly. Clean front of shelves and point of sales displays. Clean outside of unit with a damp cloth and wipe dry.

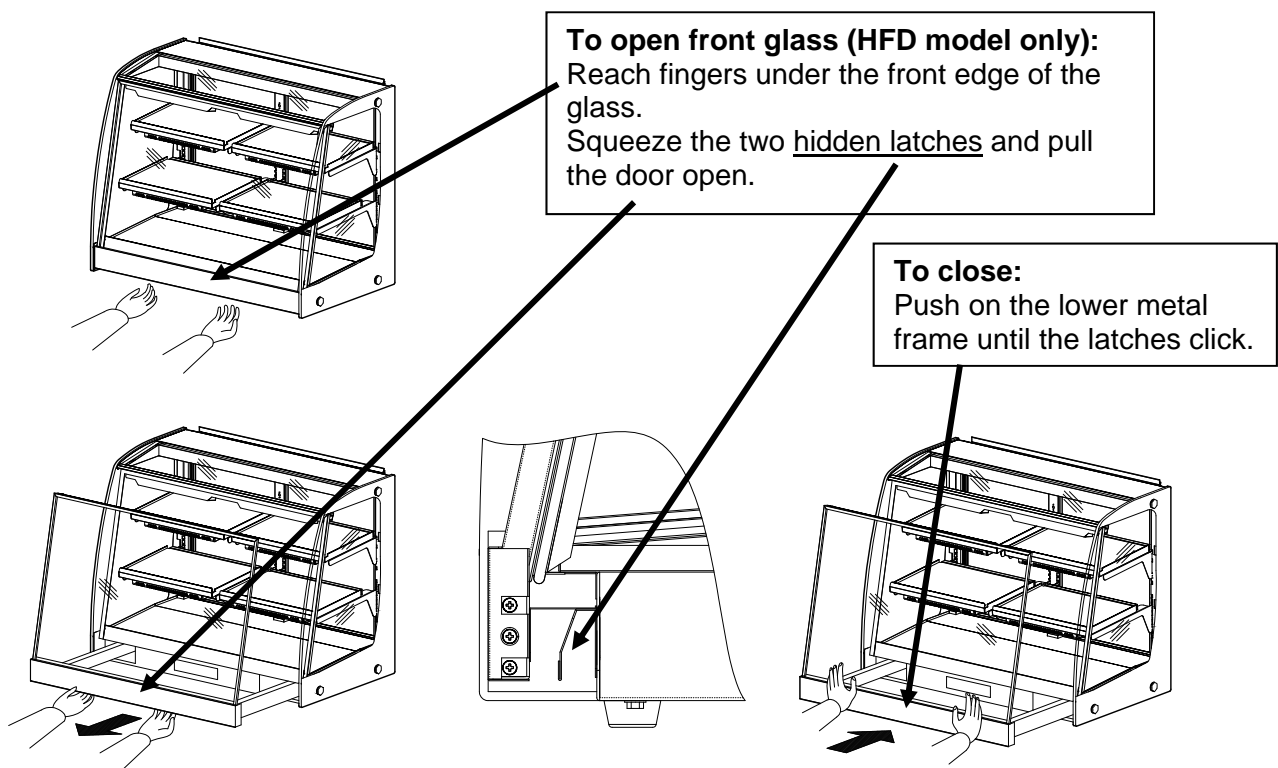

**Install Pan Stops:** for HFDH units (with or without racks), place both pan stops (part # 1242342) as shown to help prevent pans from hitting the front glass.

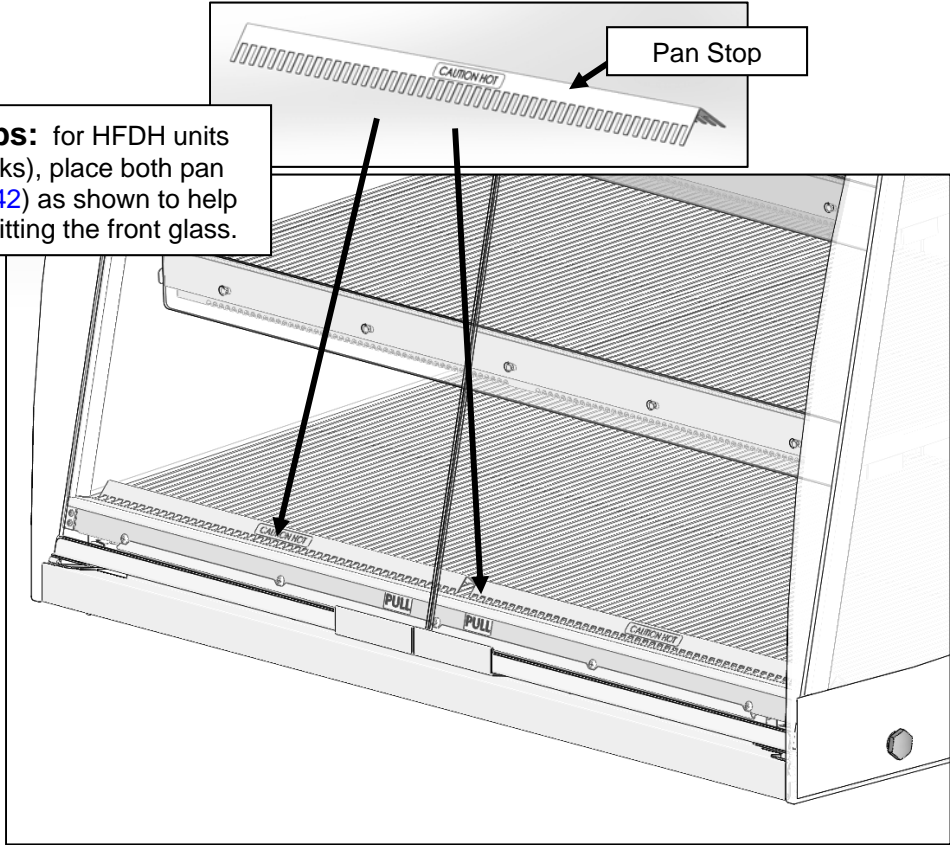

**For HFDH and HFDC units where the rear doors won't be used, install rear door keep-closed bracket.**  
 The keep-closed bracket will prevent the rear doors from opening during hot food display use.

1. Remove the outer door (lift to remove).
2. Slide the remaining door to the right.
3. Install the keep-closed bracket.
4. Reinstall the outer door and close both doors so the keep-closed bracket "locks" the doors shut.

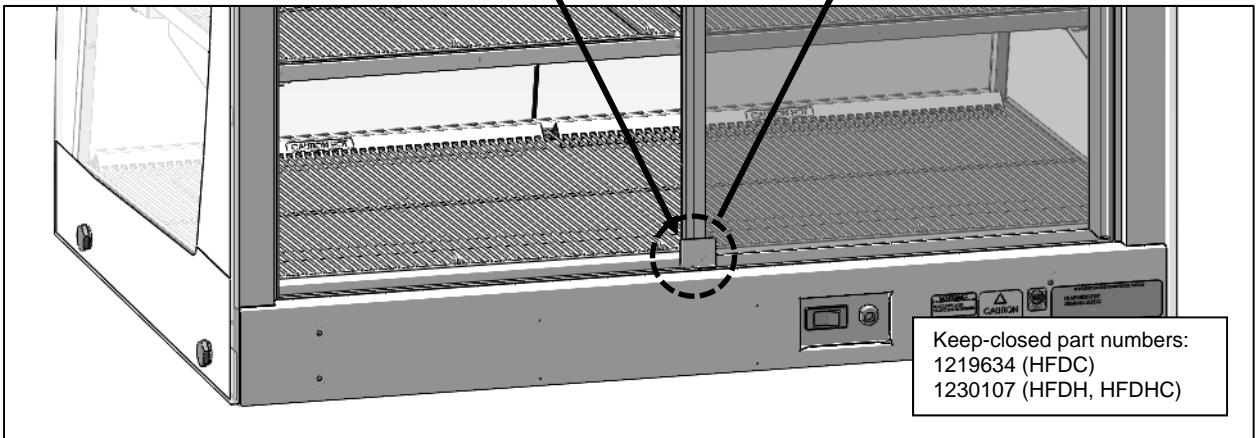
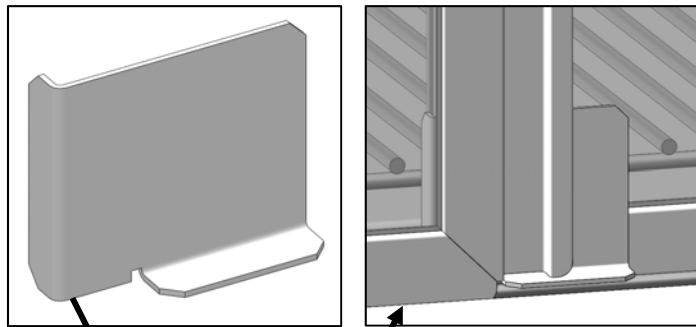

Keep-closed part numbers:  
 1219634 (HFDC)  
 1230107 (HFDH, HFDHC)

**Setup Instruction (Optional) HFDH & HFDHC Accessories**



Counter: VDPHDC001

**Bag & Tong Holders**

**VDPCAA004: Right Side**  
**VDPCAA005: Left Side**

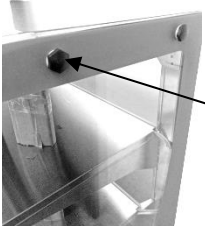

Step 1: Remove top front plastic side glass bolt.

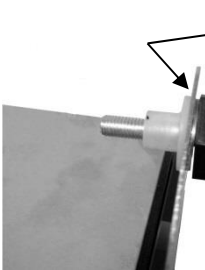

Step 2: Remove Rubber seal, place bolt and washer through bag & tong holder mounting hole. Place rubber seal over bolt on the inside.

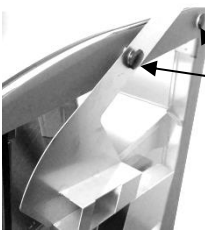

Step 3: Reinstall bolt into top front side glass. Once front bolt is installed, repeat for the top back bolt.



Step 4: Repeat steps 1-3 for the left side bag & tong holder if applicable.

**Top Mount Shelf**

**1246267**

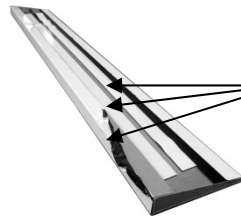

Step 1: Remove the two magnetic strips from inside and protective coating from stainless.

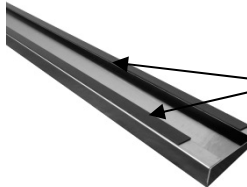

Step 2: Remove backing from magnetic strips and apply the adhesive side to the underside of the tray.

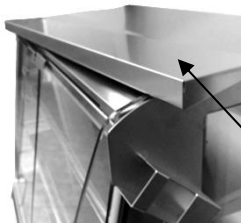

Step 3: Place tray on the top front of the display and align with the front edge.



**Sign Holder**

**1246232**



Step 1: Remove the two magnetic strips from the back side and protective coating from stainless.

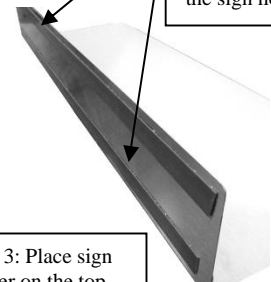

Step 2: Remove backing from magnetic strips and apply the adhesive side to the underside of the sign holder.

Step 3: Place sign holder on the top center of the Display.

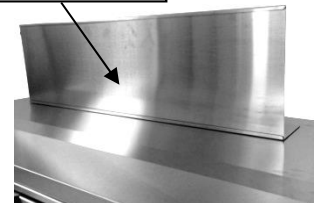

## POP Kits

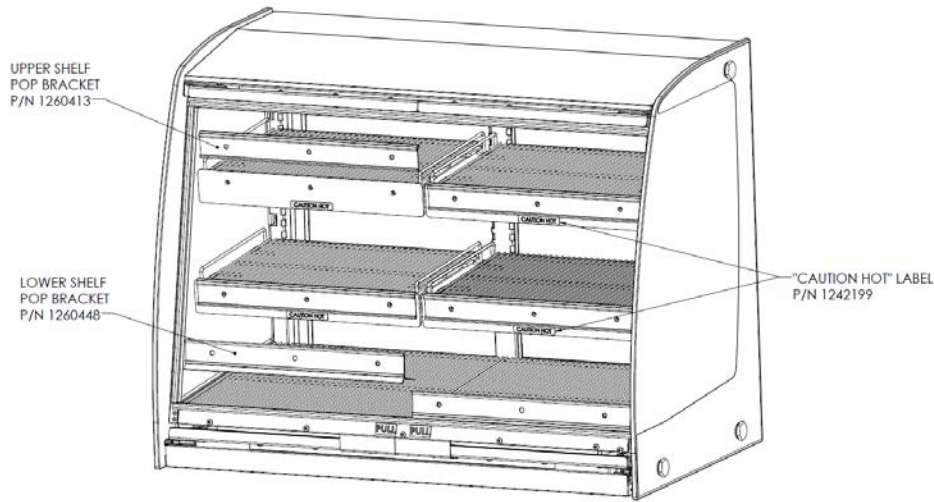

**HFDXXXXXX POP Kit**  
Part Number: **1260456**

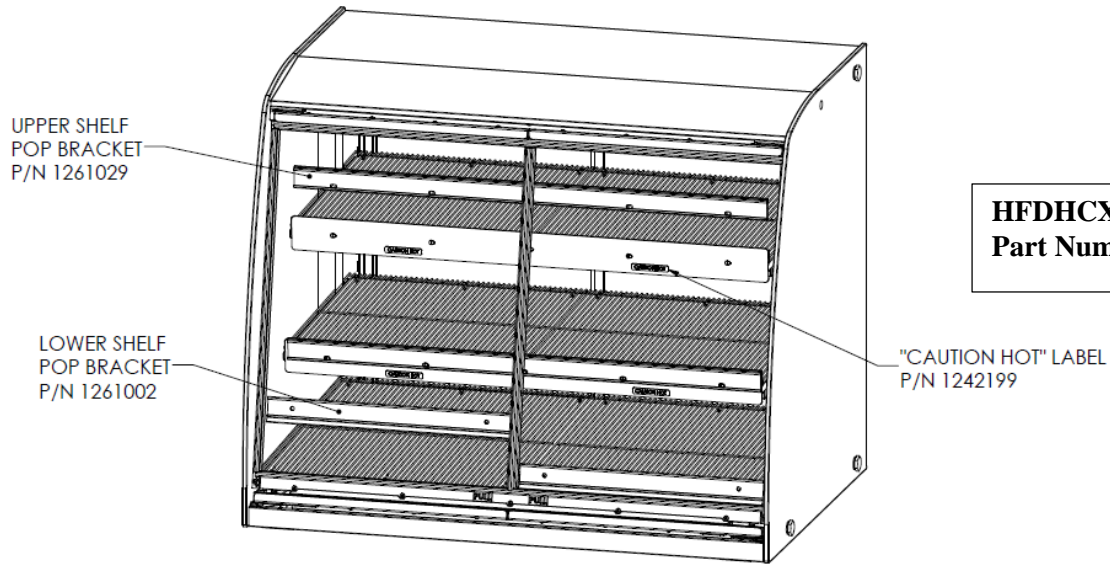

**HFDHCXXXX POP Kit**  
Part Number: **1261266**

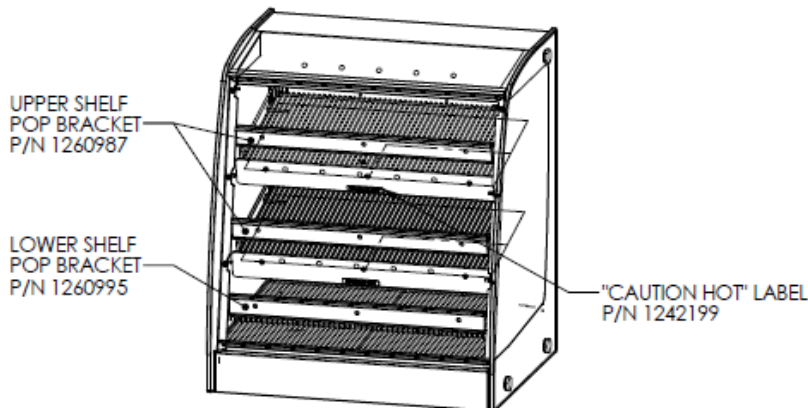

**HFDMXXXXX POP Kit**  
Part Number: **1261479**