

# PARTS MANUAL

## S Series - Rev 2020.1

Last Revision: June 2020



5610 4th Ave S. / Seattle, WA 98108—USA

Tel: +1 206 764 0600 / Fax: +1 206 764 0601

Ordering Parts: [parts@synesso.com](mailto:parts@synesso.com)

Information: [info@synesso.com](mailto:info@synesso.com)

[www.synesso.com](http://www.synesso.com)

# Table of Contents

<b>Section</b>	<b>Pages</b>
Body Panels	2-5
Body Components	6
Frame Plates and Legs	7
Group Top Assembly	8-9
Steam Tank	10-12
Right Side Hydraulics	13
Flow Meter Assemblies	14-15
Left Side Hydraulics	16
Front Side Hydraulics	17
Brew Tank	18-19
Steam Actuator, Wand, and Valve Assemblies	20-21
Electronic Displays	22
Electrical Switches	23
Electronics Box	24
Gauges and Drain Tube	25
Pump, Hoses, & Motor	26
Gaskets, Screens, and Portafilters	27-28
Wood Packages	29
Cup Mat, Food Grease, Descaler, Loctite	30

# S Series Body Panels

Body panel part numbers available on pages 3—5



# Front Body Panels

- 1.1590\_B** - S200 Black Front Panel\*
  - 1.1590\_W** - S200 White Front Panel\*
  - 1.1593\_B** - S300 Black Front Panel\*
  - 1.1593\_W** - S300 White Front Panel\*
- \*Does not include shot timers



**1.8050** - 1/4" Truss Head Screw

**1.8055** - 1/2" Truss Head Screw



- 1.7509\_B** - S200, Black, Front Splash Guard
- 1.7553\_B** - S300, Black, Front Splash Guard

# Back Body Panels

- 1.7506\_B** - S200, Black, Lower Back Cup Rail
- 1.7506\_W** - S200, White, Lower Back Cup Rail
- 1.7551\_B** - S300, Black, Lower Back Cup Rail
- 1.7551\_W** - S300, White, Lower Back Cup Rail



**1.8055** - 1/2" Truss Head Screw



**1.8485** - Push On Retainer

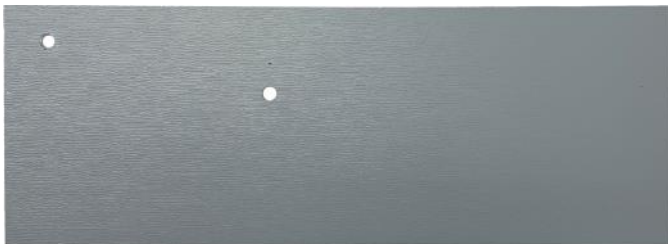

**1.1785** - Mirrored Plate  
\*Attaches on backside of panel

Panel, Back Assembly with Logo, Mirrored Plate & Fasteners

- 1.1737\_B** - Black, S200
- 1.1737\_W** - White, S200
- 1.1738\_B** - Black, S300
- 1.1738\_W** - White, S300

- 1.1357\_B** - S200 Black Upper Back Panel
- 1.1357\_W** - S200 White Upper Back Panel
- 1.1355\_B** - S300 Black Upper Back Panel
- 1.1355\_W** - S300 White Upper Back Panel



**1.1782** - Synesso "S" Logo

- 1.7508\_B** - S200 Black Back Panel Lower Trim
- 1.7508\_W** - S200 White Back Panel Lower Trim
- 1.7552\_B** - S300 Black Back Panel Lower Trim
- 1.7552\_W** - S300 White Back Panel Lower Trim

# Body Panels

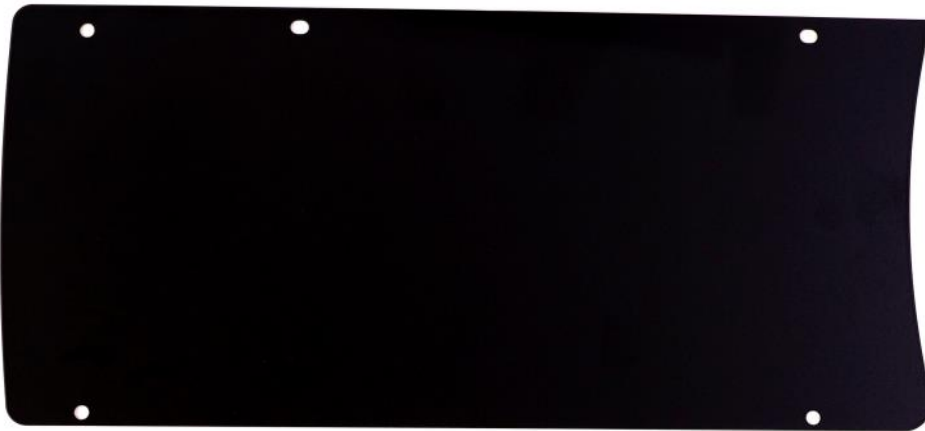

**1.8050** - 1/4" Truss Head Screw

**1.8055** - 1/2" Truss Head Screw

**1.1938\_B** - Black Side Panel

**1.1938\_W** - White Side Panel

- 1.1620\_B** - S200 Black Lower Back Panel
- 1.1620\_W** - S200 White Lower Back Panel
- 1.1623\_B** - S300 Black Lower Back Panel
- 1.1623\_W** - S300 White Lower Back Panel

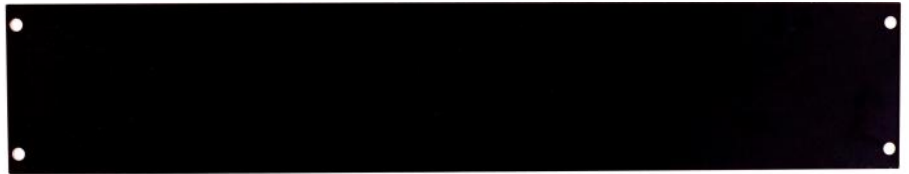

**1.8035** - 1/2" Phillips Pan Head Screw

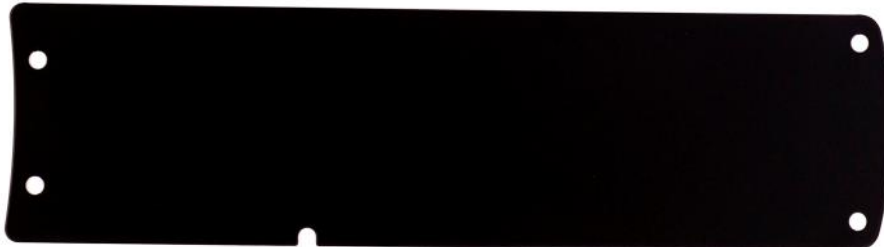

**1.1939\_B** - Black Lower Side Panel

**1.1939\_W** - White Lower Side Panel

- 1.7507\_B** - Black Side Cup Rail
- 1.7507\_W** - White Side Cup Rail



**1.7505\_B** - S200 Black Back Cup Rail

**1.7505\_W** - S200 White Back Cup Rail

**1.7550\_B** - S300 Black Back Cup Rail

**1.7550\_W** - S300 White Back Cup Rail

# Drain Pan & Grate

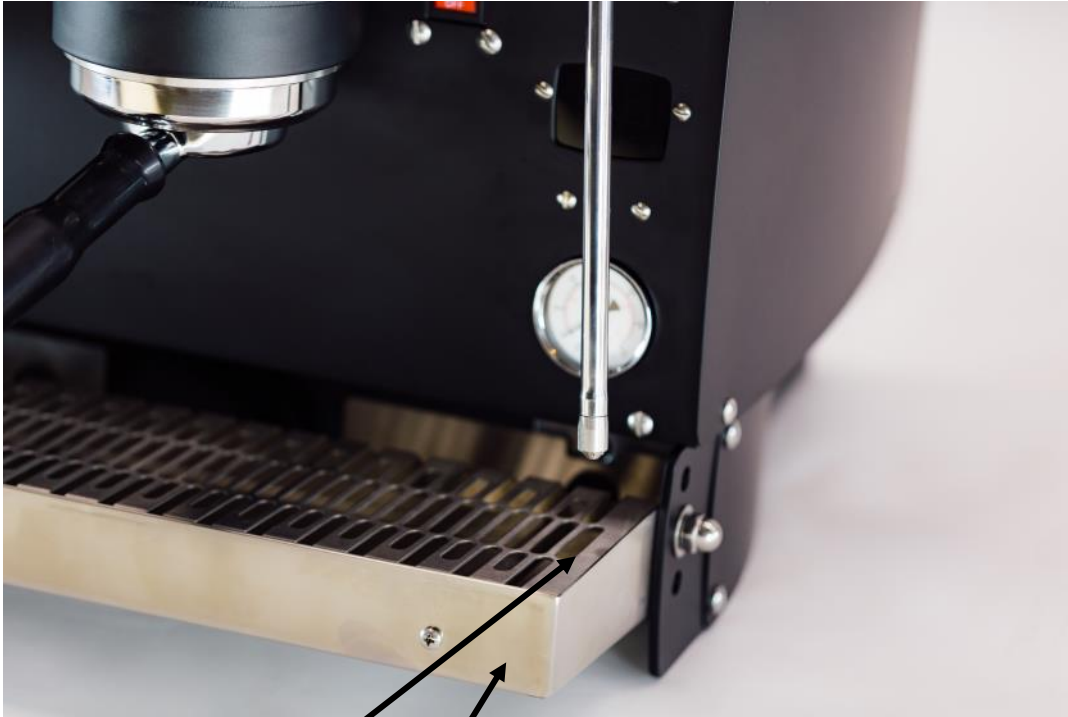

**1.1546** - Drain Grate S200  
**1.1547** - Drain Grate S300

**1.1526** - Drain Pan S200  
**1.1528** - Drain Pan S300

**1.1540\_RH** - Right Drain Tray Support  
**1.1540\_LH** - Left Drain Tray Support

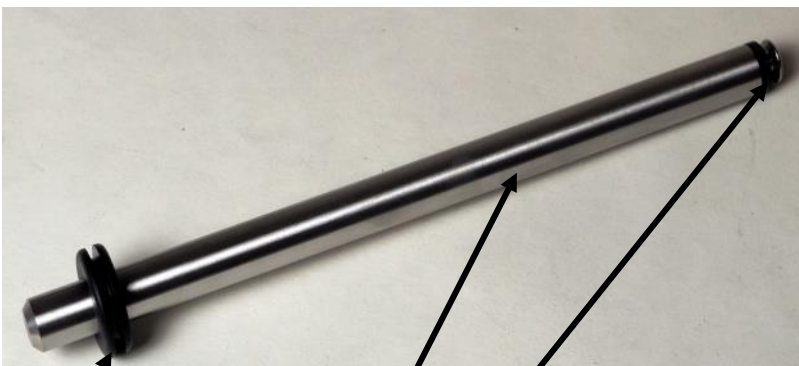

**3.2325** - Rubber Grommet

**1.1527** - Drain Pan Rod

**3.2326** - Rubber Washer

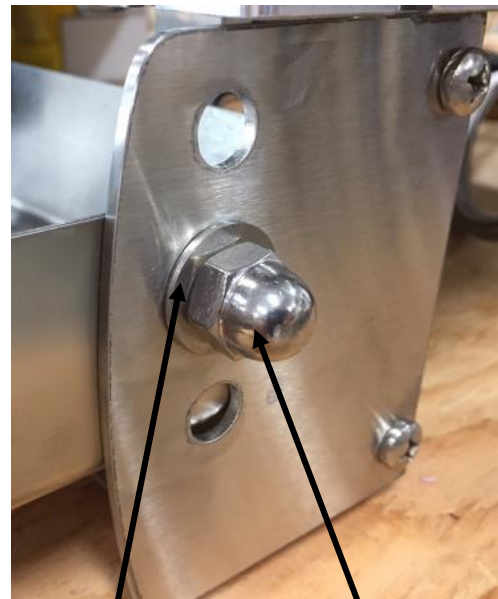

**3.6101** - Acorn Bolt Assembly

**1.8440** - Washer

# Frame Plates and Legs

**1.1747** - S200 Base Plate  
**1.1766** - S300 Base Plate

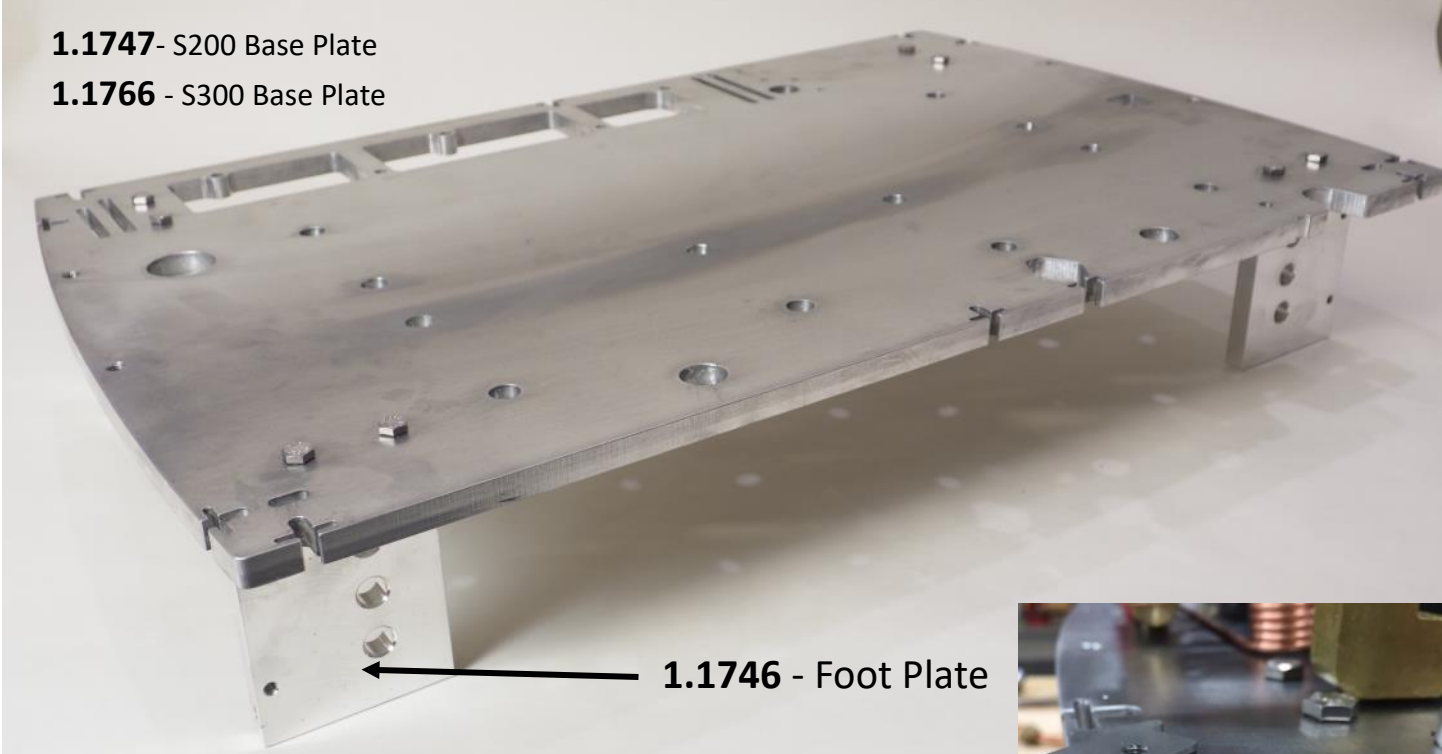

**1.1746** - Foot Plate

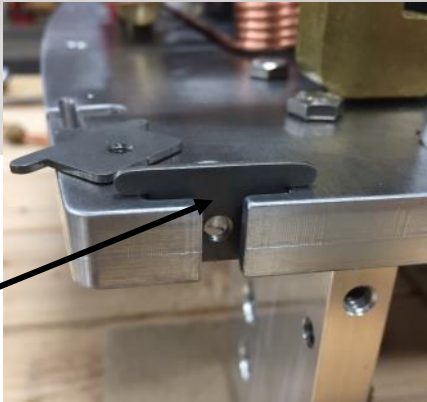

**1.1174** - Plate, Nut Insert

\*Top plate shown with removable wrapping



**3.6102\_R1** - S200 Top Plate Assembly  
**3.6302\_R1** - S300 Top Plate Assembly

Top Plate Assembly comes fully assembled with Group Actuators, Steam Actuators, Steam Valves, Nut Plates, and Hardware.

# Body Parts - Group Top



**1.1659**- Group top Handle

**3.8020** - Hex Head Screw

**1.1016\_W** - Group Top White  
**1.1016\_B** - Group Top Black  
(Does not include Handle **1.1659**)



**1.1023** - Group Top Support

**1.3381** - Bayonet Ring

**1.1047\_W** - White Group Skirt  
**1.1047\_B** - Black Group Skirt

# Group Top Actuator Assembly

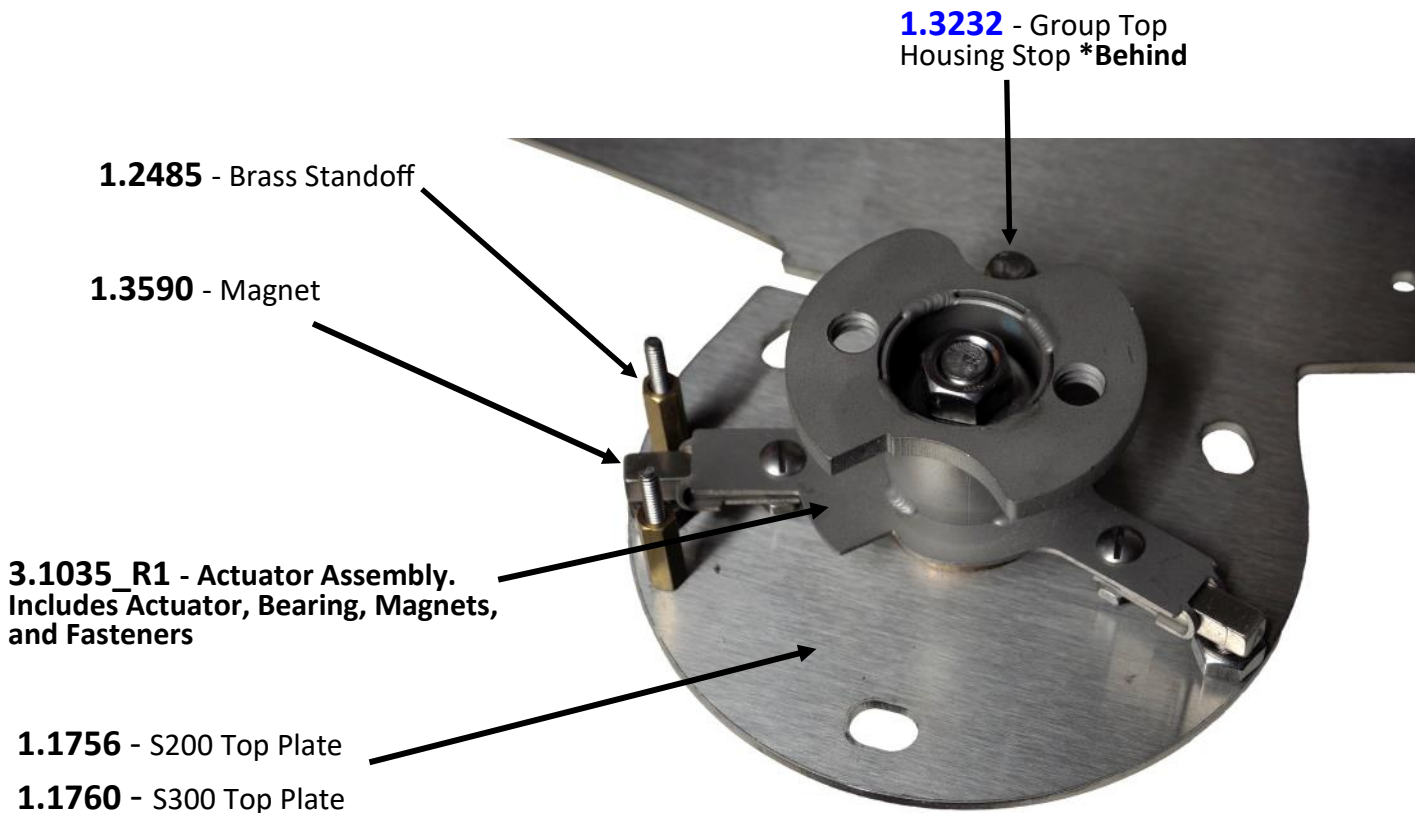

# S Series Steam Tanks

\*Shown: Complete S200 Tank Assembly



**Complete Steam Tank Assemblies Include:** All Tank Fittings, Element (w/wires and heat shrink), Hot Water Valve, Temp Probe, Thermal Overload Switches, Water Probes, PRV and Hose, Vacuum Breaker, Heat Exchange Tubes (w/ detuning tubes), Inlet Tube and Fittings, Tank Insulation.

- 5.5500 - Complete S200 Steam Tank Assembly
- 5.5550 - Complete S300 Steam Tank Assembly

## Steam Tank Right Side

\*Shown: Complete S200 Tank Assembly, Right Side

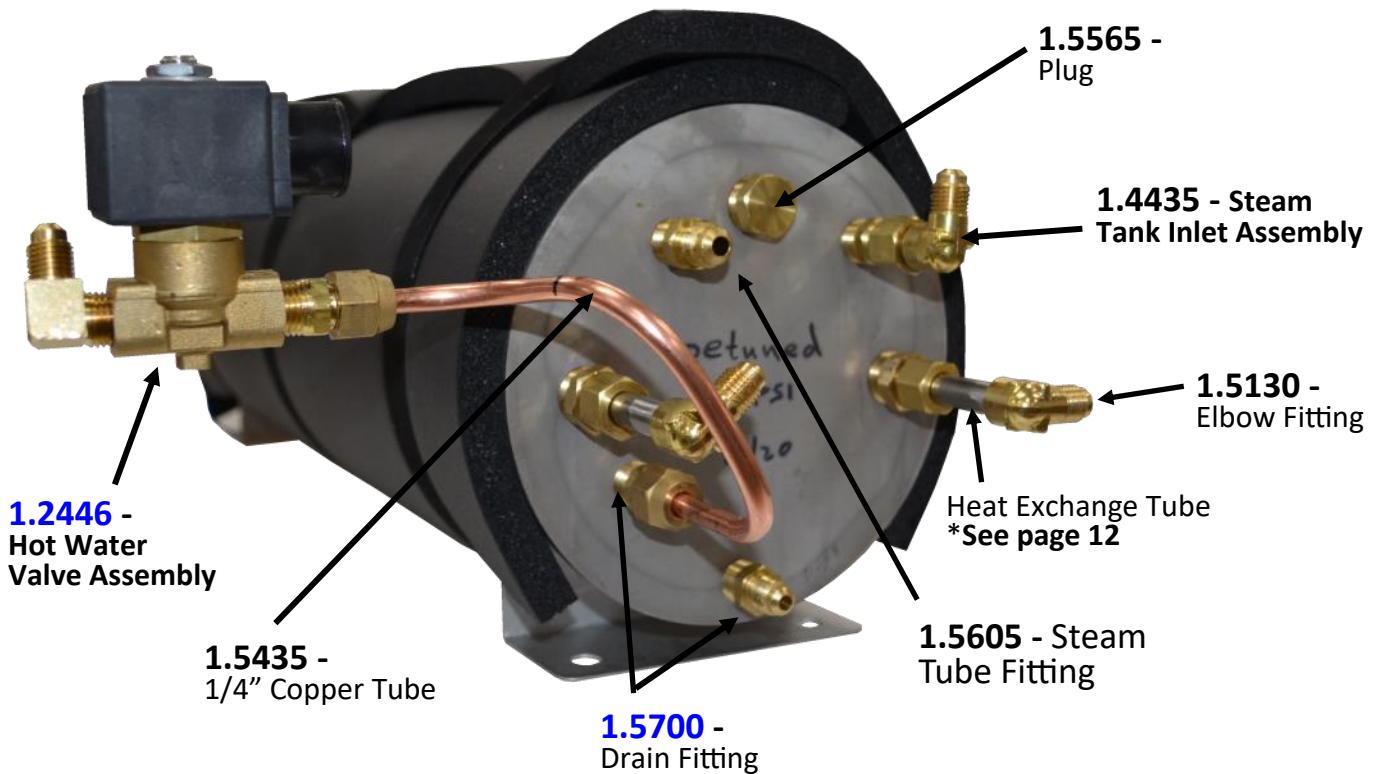

# Steam Tank Left Side

\*Shown: Complete S200 Tank Assembly, Left Side

**1.2490** - Thermal Overload Switch



**Hardware for overload switch**

- 1.8011 - Screw
- 1.8250 - Nut
- 1.8410 - Washer

**1.8920** - Silicone Cover for Vacuum Breaker

**1.5700** - Gauge Fitting

**1.5605** - Steam Tube Fitting

**1.8909** - Cable Tie

**1.5783** - Pipe Nipple

\*Vacuum Breaker and PRV shown without covers

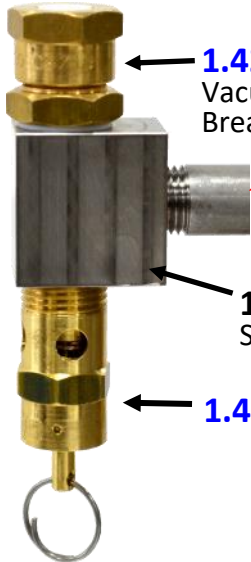

**1.4265** - Vacuum Breaker

**1.5569** - SS Tee

**1.4100** - PRV

**1.4381** - Buna Hose

**1.4192** - Teflon O-Ring

**1.4111** - Level Probe

**1.4112** - Low Probe

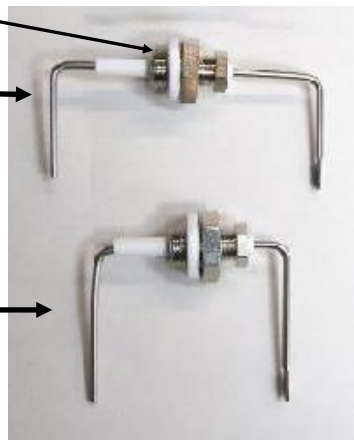

Heating Element  
\*See Page 12

**1.5530** - Heat Exchange Fitting

**1.2390** - Steam Tank and Brew Tank Temperature Probe

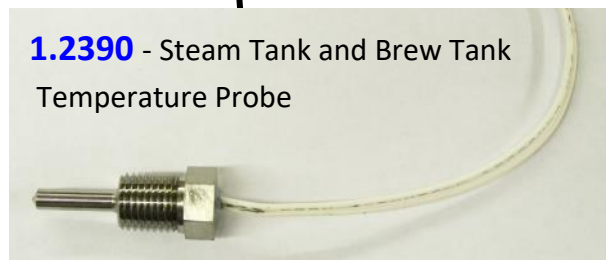

# Heating Elements and Heat Exchange Tubes

**1.2040** - 4000 Watts - S200 Steam Element

**1.2030** - 5000 Watts - S300 Steam Element



**Heat Exchange Compression Fittings** \*Same fittings shown below for left and right sides



**1.5961** - Compression Fitting

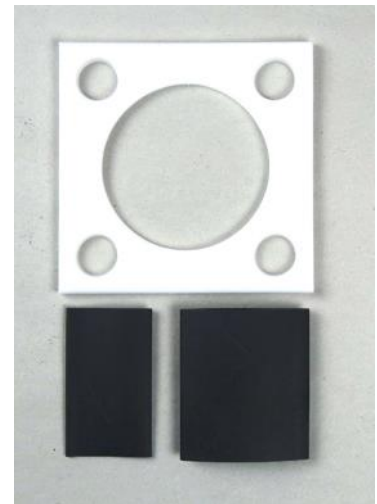

**1.2010** - Teflon Gasket for Heating Elements

**1.3821** - Heat Shrink, 1/2" Wide, 1.5" Long - Used to Protect a Single Wire Attached to the Element Post

**1.3861** - Heat Shrink, 3/4" Wide, 1.5" Long - Used when 2 Wires are Attached

**1.4451** - Detuning Tube, S200, 21", 2 Pieces

**1.4452** - Detuning Tube, S300, 32", 3 Pieces

**1.4456** - Bulk Teflon Detuning Tube, Sold by Foot

**2.4521** - S200 Heat Exchange Tube

**2.4527** - S300 Heat Exchange Tube

**1.4571** - Teflon Sleeve Insert (Not Shown)

# Right Side Hydraulics



- 1.5179** - Cold Water Tube to Tea Tap
- 1.5236** - Right Steam Tube
- 1.5435** - Steam Tank to Hot Water Tube
- 1.6753** - Jetted Steam Tank Fill Tube
- 1.5176** - Copper Brew Gauge Tube

## **1.2441** - Water Control Valve

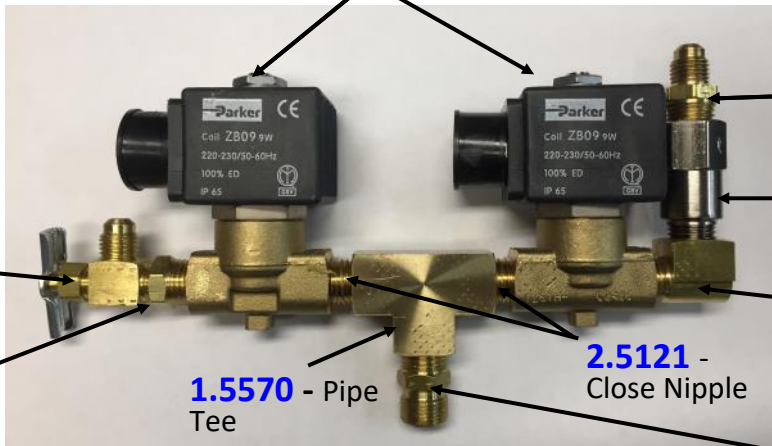

- 1.5080** - Mix Valve
- 2.5100** - Reducing Bushing
- 1.5570** - Pipe Tee
- 1.5700** - Fitting
- 1.4290** - Check Valve
- 1.5340** - Elbow Fitting
- 2.5121** - Close Nipple
- 1.5721** - 3/8" Compression Fitting

**3.6110 S Series Water Control Assembly Complete -**

# Flowmeter Assembly S200

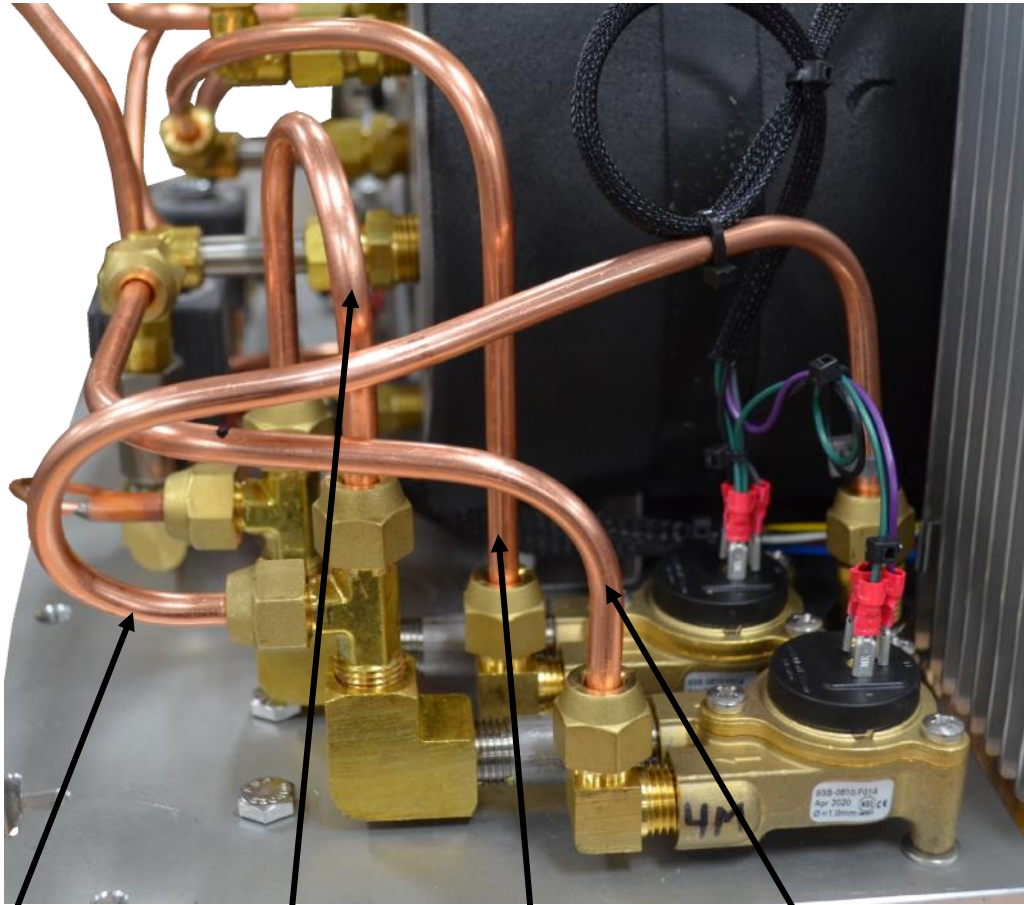

**1.5173** - Brew Inlet to Flowmeter

**1.5177** - Jumper from Flowmeter 1 to Flowmeter 2

**1.5172** - Flowmeter to Grp 1 Heat Exchange

**1.5171** - Flowmeter to Grp 2 Heat Exchange

**2.5111** - Brass Run Tee

**2.5340** - Brass Pipe Elbow

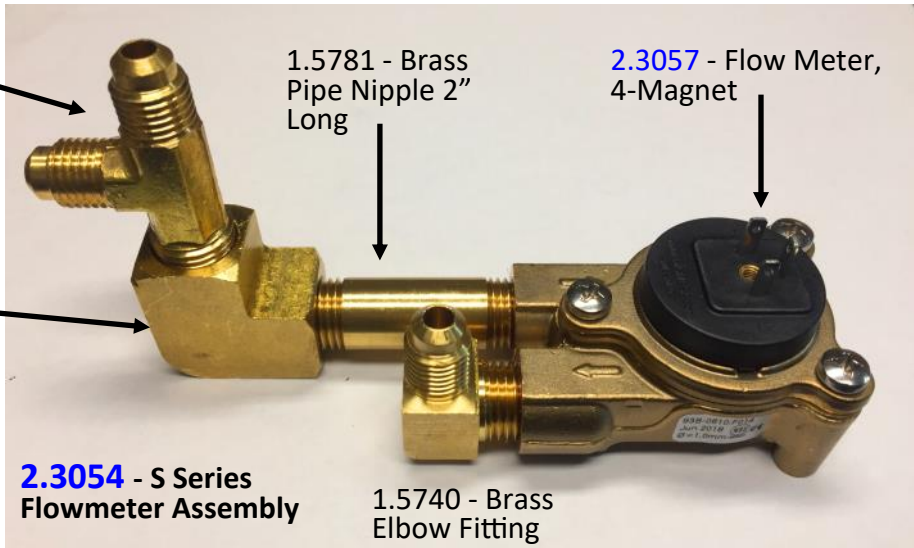

**1.5781** - Brass Pipe Nipple 2" Long

**2.3057** - Flow Meter, 4-Magnet

**2.3054** - S Series Flowmeter Assembly

**1.5740** - Brass Elbow Fitting

# Flowmeter Assembly S300



**1.5349** - Flow meter to Heat Exchange Tube, 3rd Position

**1.5373** - Flow Meter Jumper

**1.6723** - Flow meter to Heat Exchange Tube, 2nd Position

**1.5178** - Volumetric inlet Tube, S300

**1.5476** - Flow meter to Heat Exchange Tube, 1st Position

**2.2420** - Brew Inlet Assembly



**1.5700** - Brass Fitting

**1.4290** - Check Valve, 1/4", 1 Per Group

**1.5790** - Brass Fitting, 3/8" Compression

# Left Side Hydraulics

\*Shown: S300 Left Side

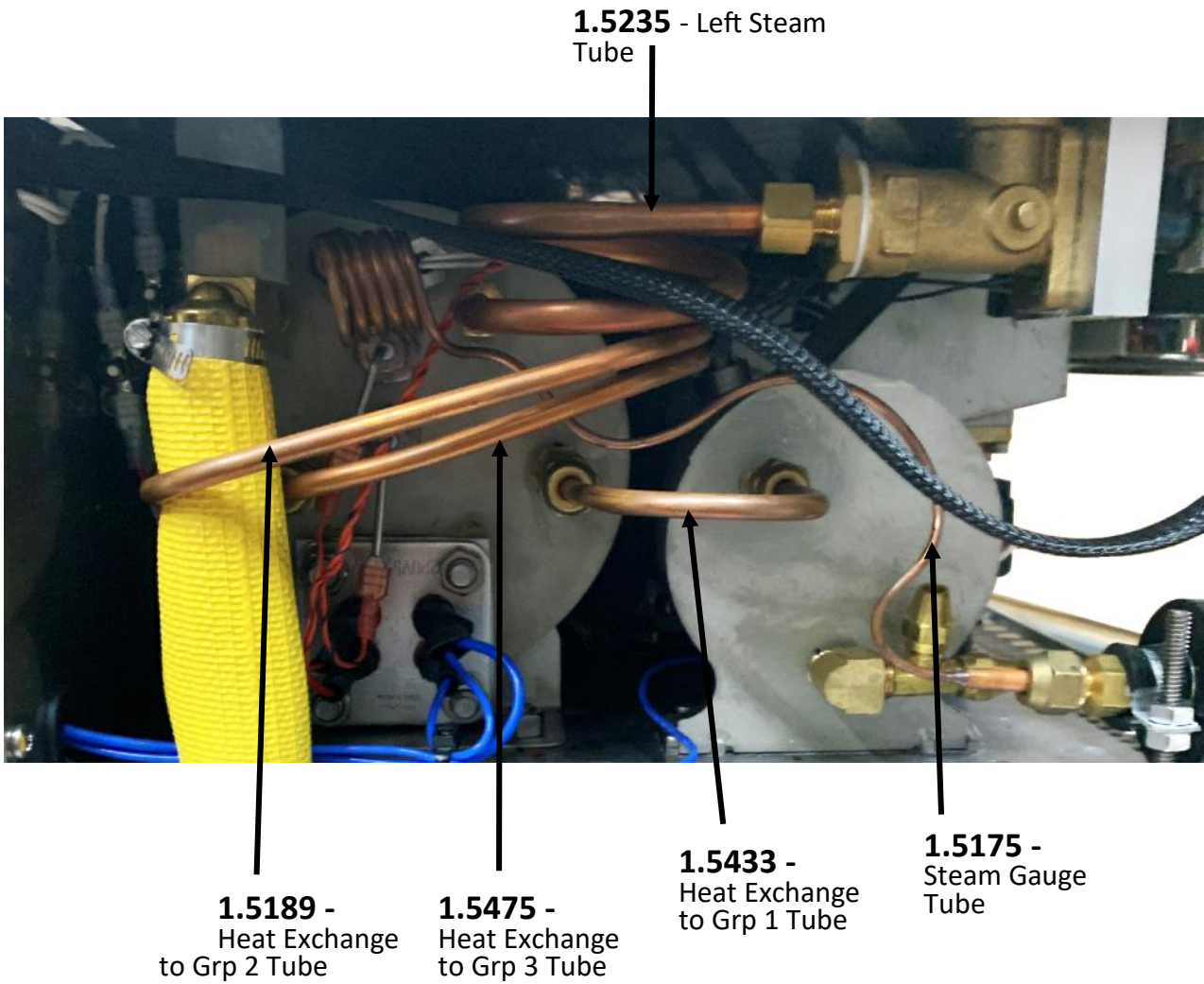

# Front Hydraulics

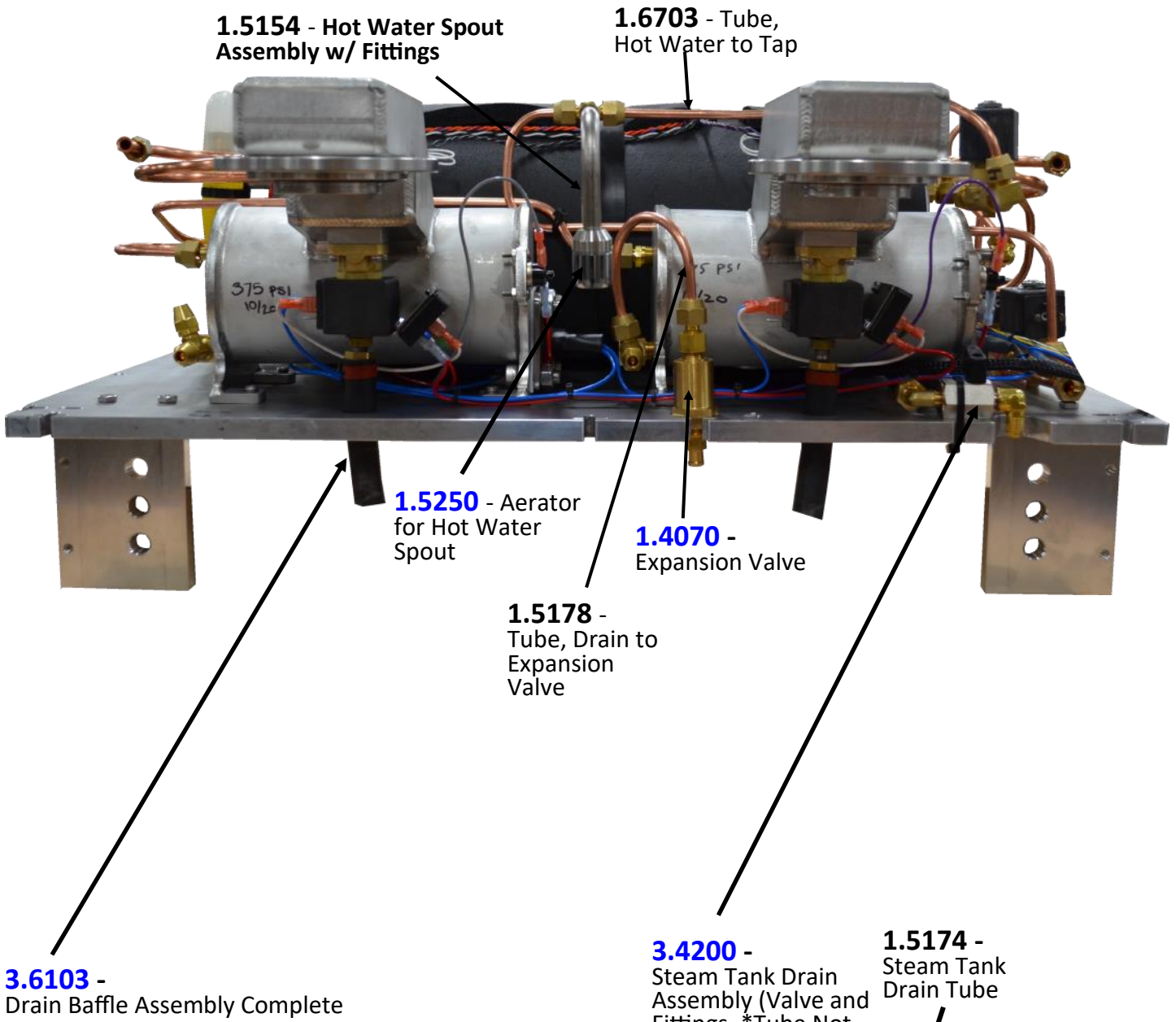

1.5835 - Discharge Fitting

1.5806 - Clamp

1.3256 - Drain Baffle Hose



# Universal Brew Tank Assembly

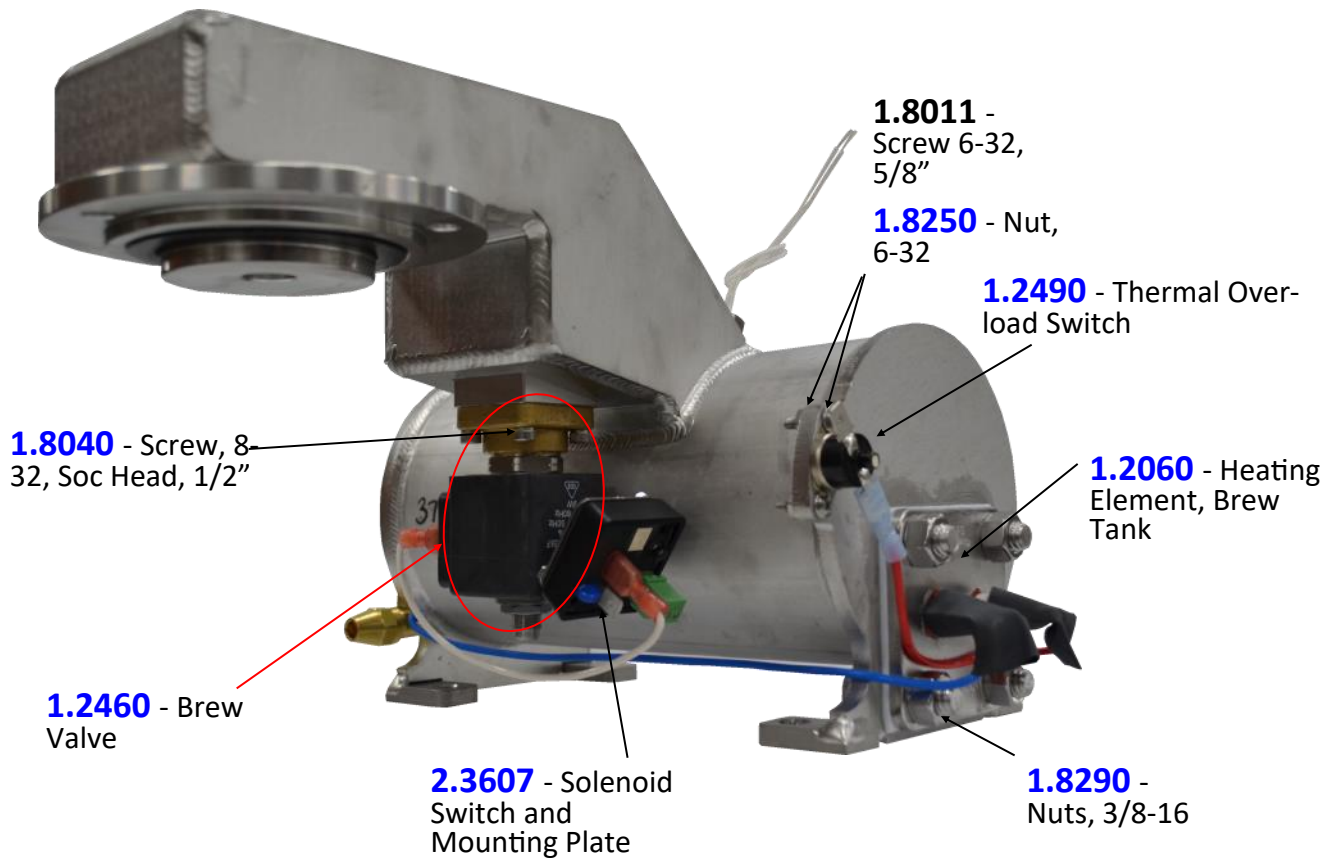

## **3.3135** Complete Brew Tank with Element, Brew Valve, Temp Probe, and Fittings

**2.4622** - New Style Brew Tank Replacement, 2 & 3 Group Machines (Tank and Brass Fittings Only)

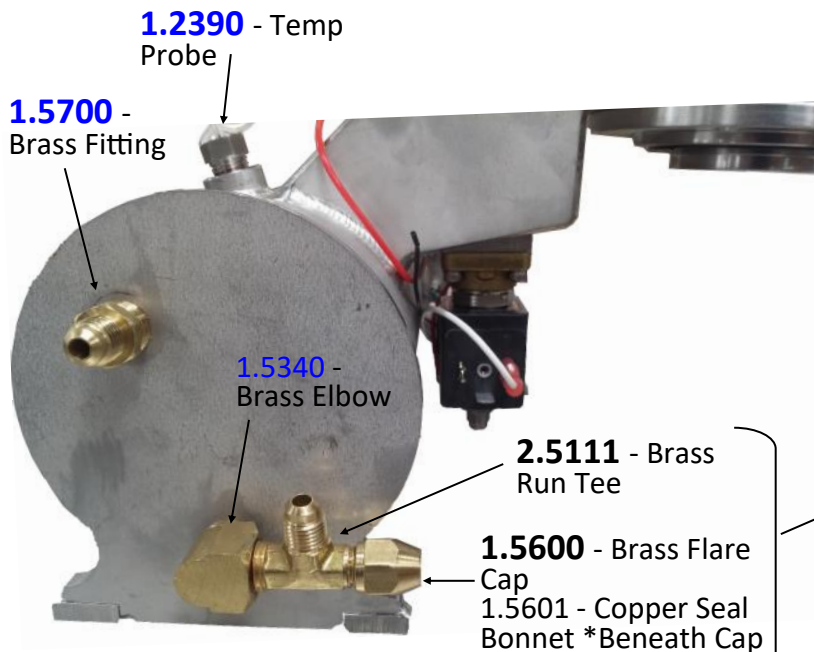

**1.5445** - Brew Tank Drain, Dual Cap



**1.5443** - Brew Tank Drain, Single Cap (For Hydra Gauge Tube)

# Universal Brew Tank Assembly Components

## Components Included in 3.3135 - Tank Assembly:

- 1.2010** - Heating Element Gasket
- 1.2060** - Element, Brew Tank, 220V, 700 Watts, Incoloy 800®
- 1.2390** - Temperature Probe, 2k Ohm
- 1.2460** - Brew Valve, 220v
- 1.2490** - Thermal Overload Switch, Manual Reset, Selco 250
- 1.3192** - Ruby Jet, .6mm
- 1.3821** - Heat Shrink Tube for Elements
- 2.3607** - Solenoid Switch with Mounting Plate
- 1.3441** - Portafilter Gasket, 8.5mm Standard

Various Fittings and Fasteners \*See Parts Indicators on Previous Page



**1.2060** - Brew Element, 700 Watts



**1.7400**—O-Rings

**1.2460**—Brew Valve, 220V, Ruby Seat, F Class

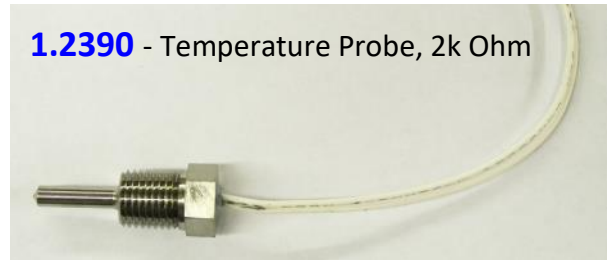

**1.2390** - Temperature Probe, 2k Ohm

**1.2490** - Thermal Overload Switch, Manual Reset, Selco 250



**1.7400** - Brew Valve O-Ring



**1.3191** - .6mm Ruby Jet Kit for Brew Valve \*standard on all machines

**1.3196** - .8mm Ruby Jet Kit for Brew Valve



**1.3441** - 8.5 mm Portafilter Gasket, Standard Size

# Steam Valve and Actuator

**1.4225** - Steam Handle

**1.8025** - Screw for Steam Handle



**1.4220** - Cam for Steam Handle



**1.1743\_R** - Right Side S Series Bearing Holder

**1.1743\_L** - Left Side S Series Bearing Holder

**1.8305** - Acorn Nut

**1.4226** - Grommet

**1.8270** - Nut

**1.8224** - Threaded Post

**1.8071** - Screw - Valve to Plate

**1.4612** - Steam Valve Pusher

**1.4502** - Steam Valve Mount

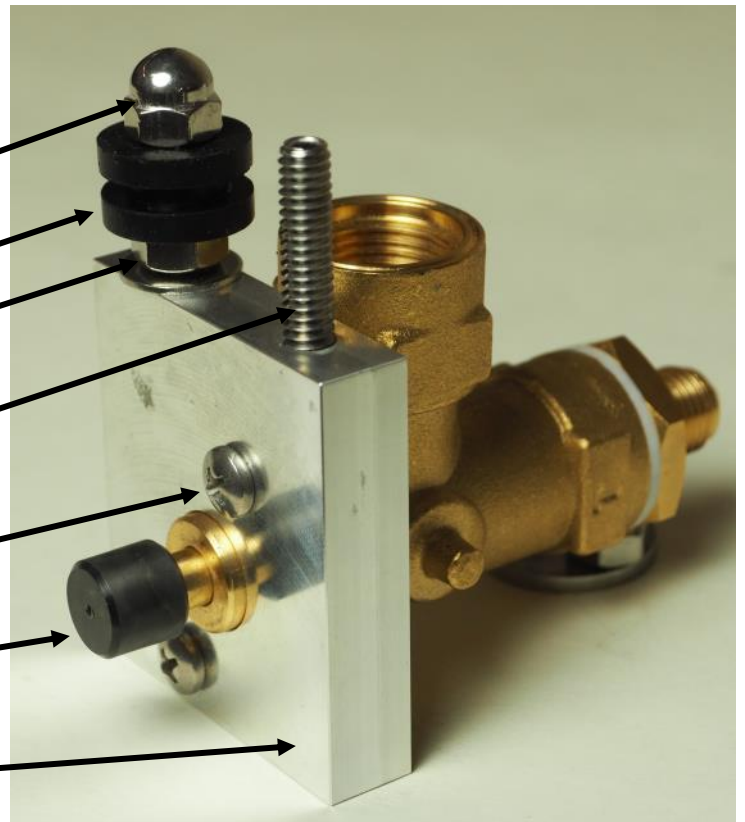

# Steam Assembly

## 1.4161 Steam Wand Assembly

\*Steam Tip Sold Separately

1.4160 - Steam Wand

1.4133 - Nut and Gasket

1.4132 - Spool and O-ring

1.4321 - O-ring  
Wand Ball

1.4133 - Nut  
and Gasket  
(1.4123)

1.4131 - Spool

1.4310 - Spool O-ring

1.4350 - Spring  
1.4505 - Seal  
Holder

1.4122 - Teflon  
Gasket

1.4200 - Seal  
for Seat

1.4181 -  
O-rings

1.4140 - Spring

1.4321 - Wand  
Ball O-Ring

1.4160 -  
Steam Wand

\*Steam Tip  
Sold Sepa-  
rately

## 1.7320—Steam Valve Rebuild Kit

1.4505

1.4200

1.4122

1.4123

1.4310

1.4321

1.4181

1.4501 - Steam  
Valve, Brass with  
Teflon Gasket.  
Pusher is Sold Sep-  
arately



1.4612 - Steam Valve  
Pusher, For Black Cast  
and Current Stainless  
Handles



## Stainless Steel Steam Tips



1.4171 - 6 Hole

1.4172 - 4 Hole

# Electronic Displays

## Handheld Controller

**2.3730 - Complete Display Controller with Cable \*S-Series Only**



**2.3730 Assembly Includes:**

- 1.4866 - Ribbon Cable, 20 Pin Round, for Handheld Display, with Molded Ends \*S Series Only
- 3.2379 - Handheld Display Assembly



**2.3720** - Board for Controller



**1.2534\_R3** - Overlay with Flexible Printed Circuit (Key Membrane)

## Shot Timers



**1.8020** - Screw, 6-32 x 1"



**2.3523**—Digital Shot Timer Control Board with LED Digits, (Mounting Hardware and Cover Not Included)



**2.3525\_Q** - Acrylic Smoke Grey Cover

**1.2486** - Brass Stand-off

**1.8250** - Nut, 6-32

## Shot Timer Ribbon Cables \*Not Shown

**3.2084** - S200

**3.2085** - S300

# Switches

Solenoid Switches (Pre-Wired)

\*No Longer Available. Order [2.3607](#)

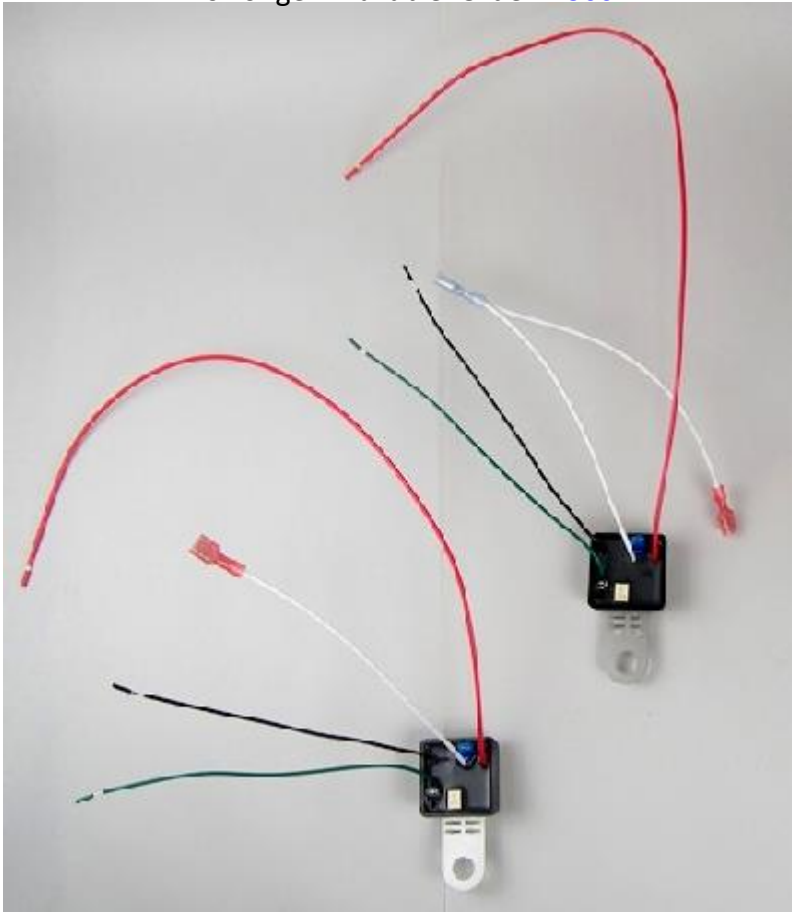

**2.3607** – New Style Solenoid Switch with Removable Terminal Connector

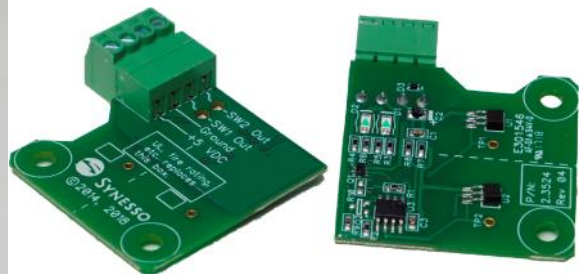

**2.3524** - Dual Hall Effect Board

**1.2317** - Purge and Tea Water Pushbutton

**1.2420** - On/Off Power

**1.2318** - Purge Switch



# Electrical Box & Relays

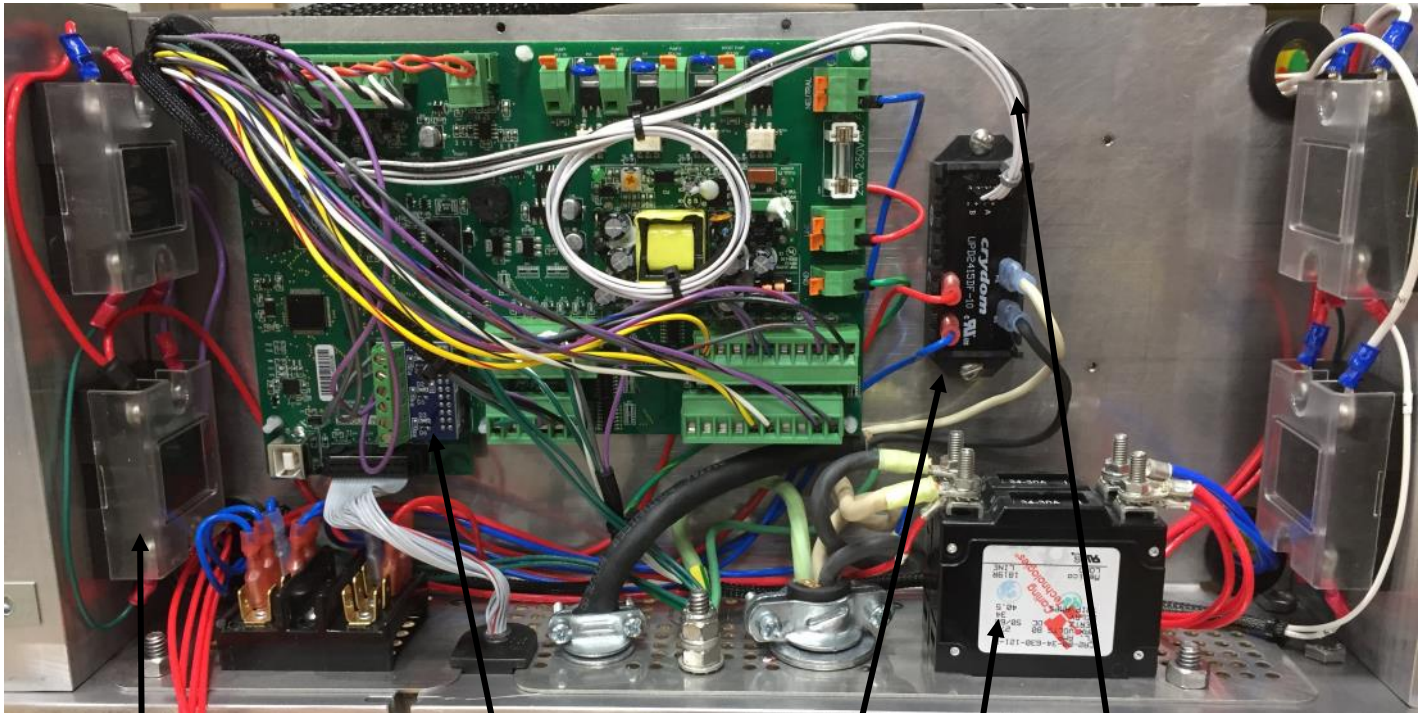

**1.4865**- 4 Pin SSR Cable

**1.2621** - S200 - 30 Amp Breaker

**1.2631** - S300 - 40 amp Breaker



**1.3740** - Solid State Low Voltage Relay, 40 amp. Used to Switch the Brew and Steam Elements.



**2.3100** - Keypad Switch Adaptor for Purge Button



**1.3752**—Low Voltage Solid



**2.3804** - Main Electronics Board with Connectors



**1.1827** - Relay Mount, S300 Only

# Gauges and Drain Hose



**1.4083** - Steam Gauge Only

## Gauge Hardware Kit - 3.6113

- 1.5805** - Clamp
- 1.8270** - Nuts
- 1.8420** - Washers
- 1.8102** - Bolt



**1.3373** - Brew Gauge Only

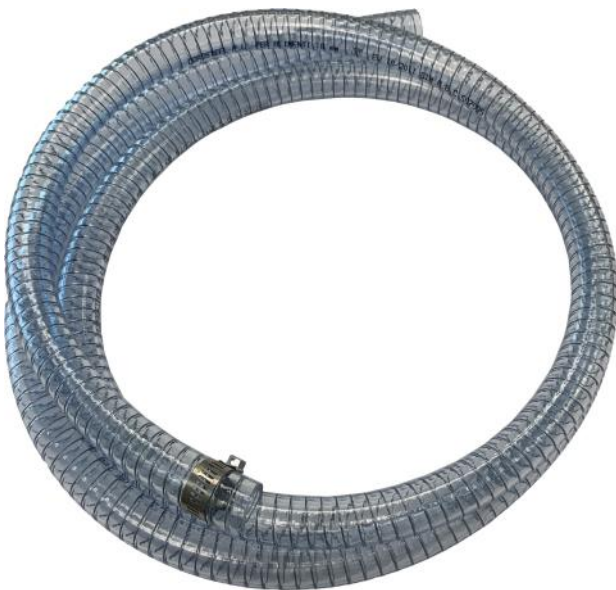

- 1.3310** - Drain Hose, 3/4" OD, Sold by the Foot
- 1.3311** - Drain Hose, 3/4" OD, Flexible, 8.3 ft
- 1.3320** - Drain Hose Clamp, 7/16"x1"

# Pump, Hoses, & Motor

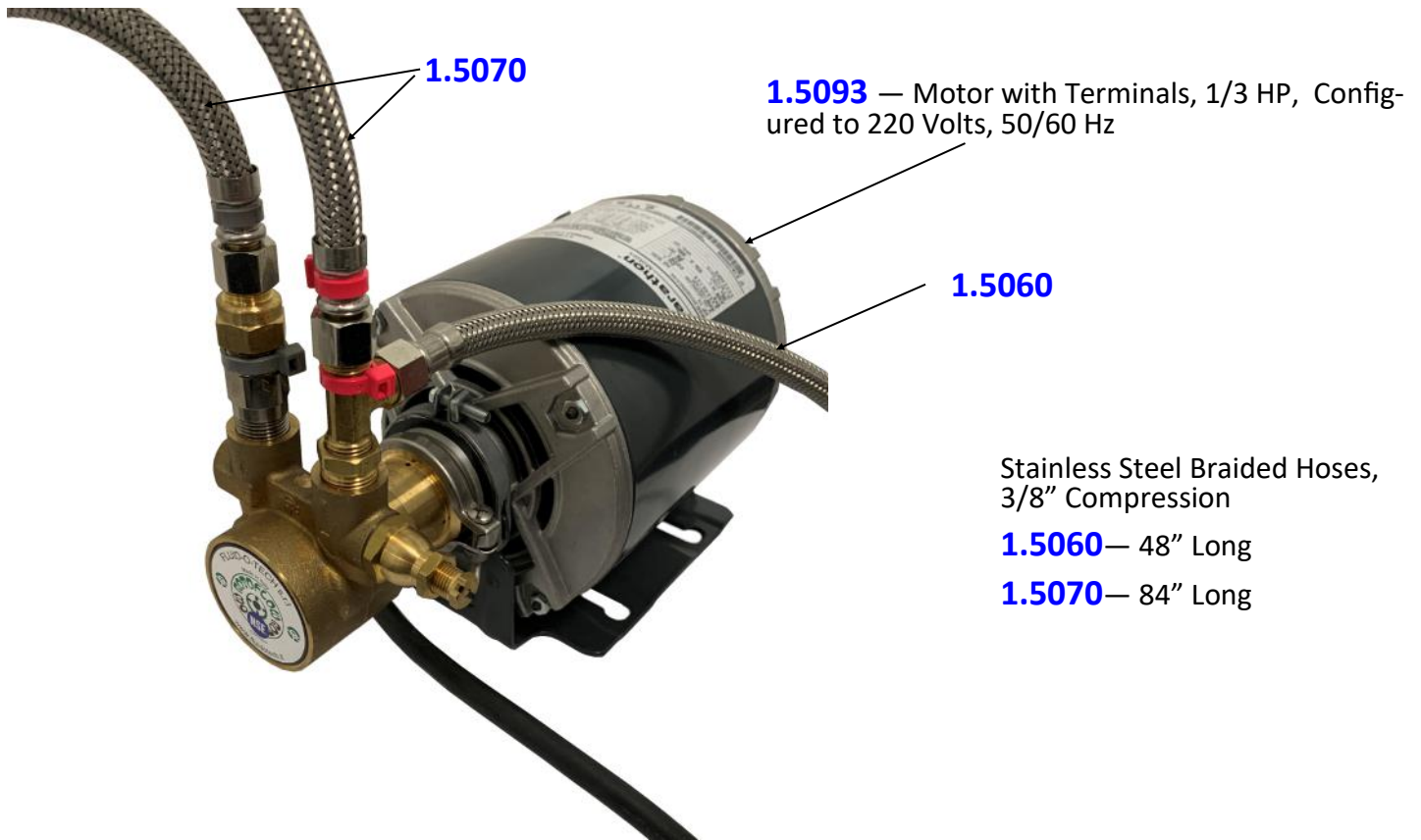

**1.5093** — Motor with Terminals, 1/3 HP, Configured to 220 Volts, 50/60 Hz

**1.5060**

Stainless Steel Braided Hoses, 3/8" Compression

**1.5060**— 48" Long

**1.5070**— 84" Long

**S Series Pump Configuration**



**1.5020** - Euro Hose and Fitting Kit

North American Hose is 3/8" Compression  
European is 3/8" BSP Parallel

**1.5000** - Euro Fitting / **1.5010** - Euro Hose



**1.5690** - Fitting

**1.5160** - Tee Fitting

**1.4060** Check Valve

**1.5170** - Fitting

**1.5115** - Pump & Clamp, Lead Free, 60 Gallons per Hour

**1.5111**—Single Pump Machine Assembly, Dual Hose (fittings and check valve included).

## Group Parts & Accessories



# Portafilters & Baskets

**1.7130** - Portafilter w/Synesso Black Handle.



**1.7041** -  
Double Spout

**1.7050** -  
Single Spout

**1.7133** - Bottomless Portafilter—NO Spring or Basket Included



**1.7132** - Double Spouted Portafilter. NO Spring or Basket Included



**1.7131** - Single Spouted Portafilter. NO Spring or Basket (Not Pictured)

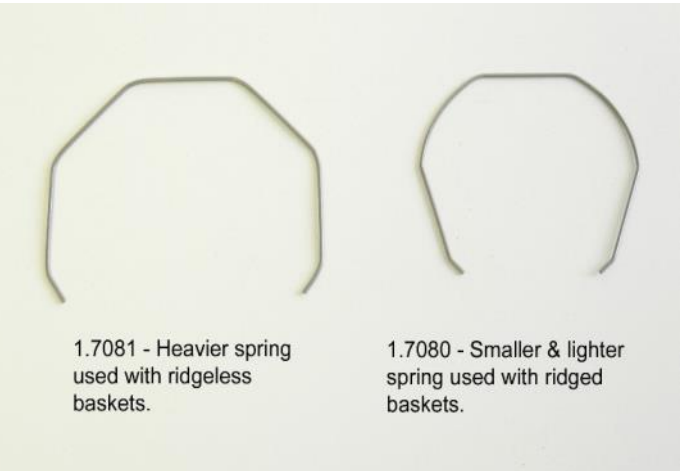

1.7081 - Heavier spring used with ridgeless baskets.

1.7080 - Smaller & lighter spring used with ridged baskets.

Portafilter Springs, Stainless Steel

**1.7080** - Thinner, 1.1 mm, Ridged Baskets

**1.7081** - Thicker, 1.2 mm, Ridgeless Baskets

**1.7010**   **1.7000**   **1.7090**   **1.7170**



7 gram  
Ridged

14 gram  
No Ridge

18 gram  
No Ridge

21 gram  
Ridged

Filter Baskets, 58 mm

## Wood Packages

### Maple



**2.7171\_2** - Wood Package S200, Maple - 2 Steam Handles, 3 Portafilters, 2 Group Top Handles

**2.7171\_3** - Wood Package S300, Maple - 2 Steam Handles, 4 Portafilters, 3 Group Top Handles

**2.7135** - Wood, Maple, Portafilter Handle Only, No Filter Head

**2.7136\_S** - Wood, Maple, Steam Actuator Handle Only, S Series

**2.7130** - Wood, Maple, Group Top Handle

### Zebra



**2.7191\_2** - Wood Package S200, Zebra - 2 Steam Handles, 3 Portafilters, 2 Group Top Handles

**2.7191\_3** - Wood Package S300, Zebra - 2 Steam Handles, 4 Portafilters, 3 Group Top Handles

**2.7155** - Wood, Zebra, Portafilter Handle Only, No Filter Head

**2.7156\_S** - Wood, Zebra, Steam Actuator Handle Only, S Series

**2.7150** - Wood, Zebra, Group Top Handle

### Black Walnut



**2.7181\_2** - Wood Package S200, Black Walnut- 2 Steam Handles, 3 Portafilters, 2 Group Top Handles

**2.7181\_3** - Wood Package S300, Black Walnut - 2 Steam Handles, 4 Portafilters, 3 Group Top Handles

**2.7145** - Wood, Black Walnut, Portafilter Handle Only, No Filter Head

**2.7146\_S** - Wood, Black Walnut, Steam Actuator Handle Only, S Series

**2.7140** - Wood, Black Walnut, Group Top Handle

### Jatoba



**2.7163\_2** - Wood Package S200, Jatoba - 2 Steam Handles, 3 Portafilters, 2 Group Top Handles

**2.7163\_3** - Wood Package S300, Jatoba - 2 Steam Handles, 4 Portafilters, 3 Group Top Handles

**2.7112** - Wood, Jatoba, Portafilter Handle Only, No Filter Head

**2.7113\_S** - Wood, Jatoba, Steam Actuator Handle Only, S Series

**2.7110** - Wood, Jatoba, Group Top Handle

# Accessories



**1.1421** - Cup Mat

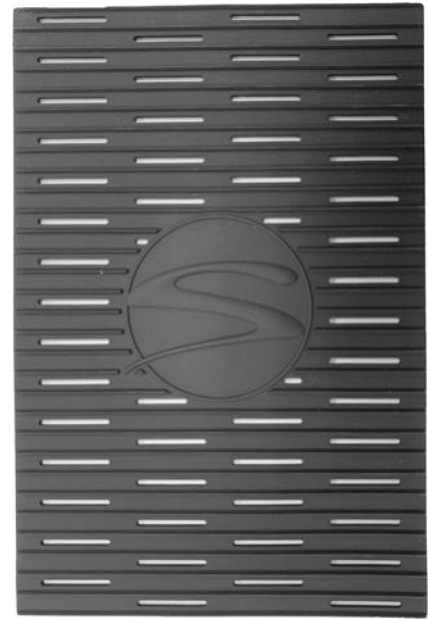

**1.1423** - Narrow Cup Mat, S300

	<p>Descaling Powder, Primary ingredient is Citric Acid. It is Non-Toxic, Biode-</p>		<p>Food Grade Synthetic Grease</p>		<p>Permanent Strength, Releases with Heat</p>
<p><b>1.7601</b> - Dezcal, 7 oz., Activat-</p>	<p><b>1.8600</b> - Super Lube, 3 oz. Tube</p>	<p><b>1.8630</b> - 0.2 oz. Tube of Thread Sealant</p>			