



Service Manual

FOR THE TURBOCHEF DOUBLE BATCH RAPID COOK OVEN



For further information, call
800.90TURBO
or
+1 214.379.6000

Original Instructions

The information contained in this manual is important for the proper installation, use, maintenance, and repair of this oven. Follow these procedures and instructions to help ensure satisfactory baking results and years of trouble-free service.

Errors – descriptive, typographic, or pictorial – are subject to correction. Specifications are subject to change without notice.

Please carefully read this manual and retain it for future reference.

Table of Contents

Important Safety Instructions

General Safety Information	i
Reducing Fire Risk	i
Grounding Instructions	ii
Power Cord Replacement or Removal	ii
Protective Earth (Ground) Symbol	ii
Equipotential Bonding Symbol	ii

Specifications and Installation

Theory of Operation	1
Features	1
Dimensions	1
Certifications	2
Oven Construction	2
Electrical Specifications	2
Installation	2
Unpacking Instructions	2
Installation Warnings - Read Before Lifting Oven	2
Lifting and Placing the Oven	3
Installation Near Open Heat Source	3
Oven Restraint Kit	4
TurboChef Connect™	4
ChefComm Pro®	4
Date and Time Prompt	4
Voltage Selection	4
Ventilation	4

Oven Maintenance

Daily Maintenance	5
Weekly Maintenance	7

Oven Controls

9

Cooking

Menu Cook Mode	10
Manual Cook Mode	12

Info Mode

Information Screen	13
Counters Screen	13
Counters Screen - Fault Log	13

Options Screen	14
Options Screen - Editing	14
Options Screen - Cook More	14
Options Screen - Load Menu	14
Options Screen - VAC Setting	14
Options Screen - Demo Mode	14
Options Screen - Manual Cooking	14
Options Screen - Diagnostic Mode	14
Options Screen - F2 Bypass	14
Settings Screen	14
Settings Screen - Temperature Measurement	14
Settings Screen - Phase	14
Settings Screen - Language	14
Settings Screen - WiFi Network	15
Settings Screen - Volume	15
Settings Screen - Date	15
Settings Screen - Time	16
Settings Screen - Cooling	16
Service Screen	16
MFG Screen	16
Edit Mode	
Edit Set Temperature	16
Edit Item Settings and Menu/Group/Item Names	16
Loading and Saving Menus	18
Troubleshooting	19
Fault Code Descriptions	19
Fault Code Troubleshooting	21
F1-1/F1-2: Blower	21
F2-1/F2-2: Low Temp	22
F6: EC Temp	23
F7-1/F7-2: RTD Open	23
F8-1/F8-2: Heat Low	24
F9-1/F9-2: CC Temp High	24
F10: Communication Failure	25
F12: Firmware Reboot	25
Non-Fault Code Troubleshooting	26
“Door Open” Message when Door is Closed	26
No Display – Screen is Blank	27
Touch Screen is Locked Up or Unresponsive	28

Troubleshooting Continued...

Touch Screen is Wrong Color or Fuzzy	28
Oven Keeps Cooling Down, Warming Up, or Turning Itself Off	29
Menu Will Not Load – USB	30
Firmware Will Not Update	31
Food Not Cooking Properly	32
Steam Present During or After Cooking	33
No Beep or Beep Too Soft	33
Wi-Fi Menu Download Will Not Work	34

Oven Systems and Components

Controls System	35
Control Board (SAGE)	35
Cooling Fans	35
Display and UI Control Board (Phoenix)	35
EMI Filters	35
Fuses	35
Micro SD	35
Power Cord	35
12V Power Supply	35
24V Power Supply	35
Relays, K1, K2, K3, & K4	36
Relays, Solid State, K5/K6 & K7/K8	36
Relay, K9	36
RTD	36
Thermostat, Cooling Fan	36
Thermostat, High-Limit	36
USB Port	36
Voltage Sensor	36
Wire Harness	36
WiFi Module	36
Convection System	37
Blower Motors	37
Blower Motor Speed Controllers	37
Heaters	37
Jetplates	37
Jetplate Support Rails	37
Oven Rack	37
Rack Oscillation Motor	37
Swing Arm Assembly	37

Oven Door	38
Door Gasket	38
Door Interlock Switches	38
Filtering System	39
Grease Filter	39
Catalytic Converter	39
Oven Schematics	
Oven Schematic	41
Control Board and Heater Schematics	42
Appendix – Replacing Oven Components	
Oven Face and Removable Cavity Components	A-1
Oven Door	A-4
Oven Components, Side Panel Removed	A-6
Oven Components, Controls	A-8
Oven Components, Back Panel Removed	A-10

*This page intentionally
left blank.*

IMPORTANT SAFETY INSTRUCTIONS

WARNING: When operating this oven, strictly adhere to the following safety precautions to reduce the risk of burns, electric shock, fire, injury, damage to oven or property near oven.

GENERAL SAFETY INFORMATION

- ✓ Read all instructions before using this appliance.
- ✓ This appliance must be grounded. Connect only to a properly grounded outlet. See “Grounding Instructions” on page ii.
- ✓ Install or locate this appliance only in accordance with the provided installation instructions.
- ✓ This appliance should be serviced by qualified service personnel only. Contact the nearest authorized service facility for examination, repair, or adjustment.
- ✓ Keep the cord away from heated surfaces.
- x DO NOT use corrosive chemicals or vapors in this appliance; it is not designed for industrial/laboratory use.
- x DO NOT allow children to use this appliance.
- x DO NOT operate this appliance if it has a damaged cord or plug, is not working properly, or has been damaged or dropped. See “Power Cord Replacement” found on page ii.
- x DO NOT cover or block any openings on this appliance.
- x DO NOT store this appliance outdoors.
- x DO NOT use this product near water (e.g., near a kitchen sink, in a wet basement, near a swimming pool).
- x DO NOT immerse the cord or plug in water.
- x DO NOT let the cord hang over the edge of a table or counter.
- x DO NOT use a water jet for cleaning.
- x **WARNING:** Due to the nature of the appliance, the floors around it may be slippery.
- x This appliance is not to be used by children or persons with reduced physical, sensory or mental capabilities, or lack of experience and knowledge, unless they have been given supervision or instruction.

REDUCING FIRE RISK

- ✓ If materials inside the oven ignite, keep the oven door closed, turn the oven off, and disconnect the power cord or shut off power at the fuse or circuit breaker panel.
- ✓ If smoke is observed, switch off or unplug the oven. Keep the doors closed to stifle any flames.
- x DO NOT use the cook cavity for storage purposes.
- x DO NOT overcook food. Carefully attend to the oven if paper, plastic, or other combustible materials are placed inside the oven to facilitate cooking.
- x DO NOT leave paper products, cooking utensils, or food in the cavity when the oven is not in use.

GROUNDING INSTRUCTIONS

This appliance must be grounded. In the event of an electrical short circuit, grounding reduces the risk of electric shock by providing an escape wire for the electric current. This oven is equipped with a cord that has a grounding wire with a grounding plug, which must be plugged into an outlet that is properly installed and grounded. Consult a qualified electrician or serviceman if uncertain about the ability to follow grounding instructions or if in doubt as to whether the appliance is properly grounded.

- x DO NOT use an extension cord. If the power cord is too short, have a qualified electrician or serviceman install an outlet near the appliance.

 **WARNING:** Improper grounding can result in risk of electric shock.

POWER CORD REPLACEMENT OR REMOVAL

If the power cord is damaged, it must be replaced by the manufacturer, its service agent, or a similarly qualified person.

 **WARNING:** If the oven is unplugged during service or maintenance, the user must be able to access and see the plug at all times to ensure that the oven remains unplugged. The plug must remain near the oven and cannot be placed behind another appliance or in another room.

PROTECTIVE EARTH (GROUND) SYMBOL



This symbol identifies the terminal which is intended for connecting an external conductor for protection against electric shock in case of a fault, or the terminal of a protective earth (ground) electrode.

EQUIPOTENTIAL BONDING SYMBOL



This symbol identifies the terminals which, when connected together, bring the various parts of an equipment or of a system to the same potential, not necessarily being the earth (ground) potential, e.g. for local bonding.

SAVE THESE INSTRUCTIONS

Specifications and Installation

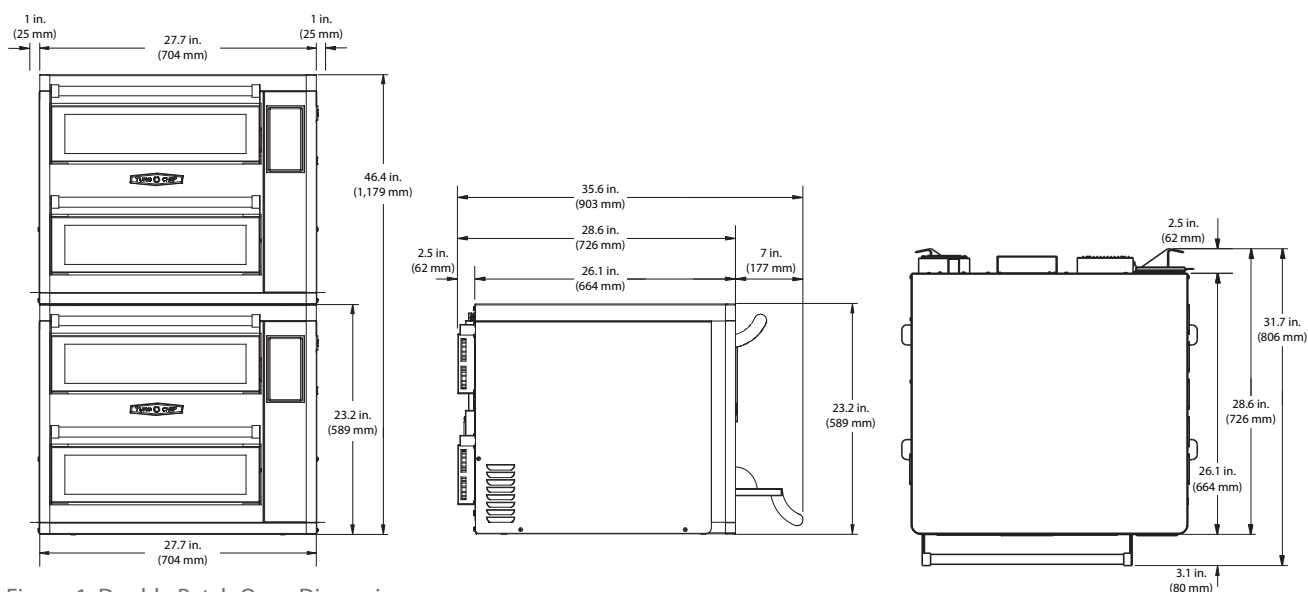

Figure 1: Double Batch Oven Dimensions

Theory of Operation

The Double Batch oven provides superior cooking performance while requiring minimal space and energy consumption. The oven circulates impinged air at speeds of up to 60 mph to create high heat transfer rates and reduce cook time. The technology includes utilizing a variable speed blower, oscillating rack, and catalytic converter, resulting in minimal energy input, high food quality, and UL®-certified ventless operation (see page 4 for details).

This manual includes instructions for installing, cleaning, operating, and servicing Double Batch ovens. If you have questions that are not addressed in this manual, contact Customer Support at 800.90TURBO (+1 214.379.6000) or your Authorized Distributor.

Features

- Simple and intuitive touch controls
- Multi-language user interface
- Variable-speed High h recirculating air impingement
- Oscillating rack for high heat transfer without spotting
- Half-sheet pan/16-inch pizza capacity
- Stackable design (requires stacking kit)
- Smart menu system capable of storing up to 800 recipes: 400 per cavity
- Built-in self diagnostics for monitoring oven components and performance
- USB menu and firmware updates
- TurboChef Connect (Wi-Fi) compatible

Dimensions

Oven Dimensions

- Height (single oven): 23.2" (589 mm)
- Height (stacked ovens): 46.4" (1,179 mm)
- Width: 27.7" (704 mm)
- Depth (door closed): 31.7" (806 mm)
- Depth (door open): 35.6" (903 mm)
- Weight: 262 lb. (119 kg)

Cook Cavity Dimensions

- Height: 3.3" (84 mm)
- Width: 18.1" (318 mm)
- Depth: 17.07" (434 mm)
- Volume: 0.59 cu.ft. (16.7 liters)

Clearances

- Top: 2" (51 mm)
- Sides: 2" (51 mm)

NOTE: 5" (127 mm) side clearance is required if the oven is placed next to another Double Batch oven.

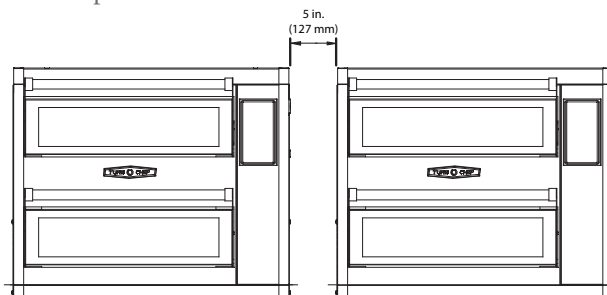

Certifications

cULus, UL EPH, FDA, TÜV, CE



Oven Construction

Exterior

- Stainless steel front, top, and sides
- Rubber seal for surface mounting

Interior

- 304 stainless steel
- Two fully insulated cook chambers
- Top and bottom jetplates

Electrical Specifications

TurboChef recommends a Type D circuit breaker for all installations outside the United States.

Single Phase

US/Canada: 208/240 VAC*, 60 Hz, 50 A,
8,320/9,600 watts

3 Phase Delta

US/Canada: 208/240 VAC*, 60 Hz, 30 A,
8,320/9,600 watts

* US/Canada models include a voltage sensor that detects 208 or 240 VAC, but does not compensate for lack-of or over-voltage installations.

Installation

Install or locate this appliance only in accordance with the instructions below.

Unpacking Instructions

1. Remove the oven from its packaging.
2. Before discarding, check the packaging thoroughly for accessories and literature.
3. Check the cook cavities thoroughly for accessories and literature.
4. Remove any packaging in the cook cavities.

Installation Warnings - Read Before Lifting Oven



WARNING: The Double Batch oven weighs approximately 262 lb. (119 kg). Never lift with fewer than two people.



WARNING: Never lift the oven from the front and rear or by the door handles. Doing so will cause the doors to misalign, resulting in a non-warranty service call.



WARNING: The oven must be properly placed on a food station at all times. TurboChef will not recognize a fallen oven as a warrantable claim and is not liable for any injuries that may result.



WARNING: This oven is not intended for built-in installation (i.e., installing the oven in any structure that surrounds the oven by five or more sides). Be sure to provide a minimum of 2" (51 mm) clearance for all sides and 2" (51 mm) clearance for the top.



WARNING: This oven is intended to be stacked only with the appropriate hardware. Contact TurboChef for details.

Lifting and Placing the Oven

1. Prepare a surface at least 28.6" (726 mm) deep and capable of supporting 262 lb. (119 kg).
2. Position one or more persons at the left and right sides of the oven.
3. Place hands under the oven and lift.
4. Place the oven on the prepared surface, ensuring no edges are hanging off the sides.
5. Ensure the oven rack is properly installed. When properly installed, the rack rests on oscillating pins.
6. Plug in the oven.

Installation Near Open Heat Source

When placing a TurboChef oven near an open heat source (Figure 2), strictly adhere to the following:

- If the oven is being placed near a grill or stove, a divider must exist between the oven and the open heat source, with a minimum of 6" (152 mm) between the oven and the divider.
- If the oven is being placed near a fryer, a divider must exist between the oven and fryer, with a minimum of 12" (305 mm) between the oven and the divider.
- The height of the divider must be greater than or equal to the height of the oven (23.2" or 589 mm).
- Verify the oven location has a minimum 2" (51 mm) clearance on top and a minimum 2" (51 mm) clearance on each side.

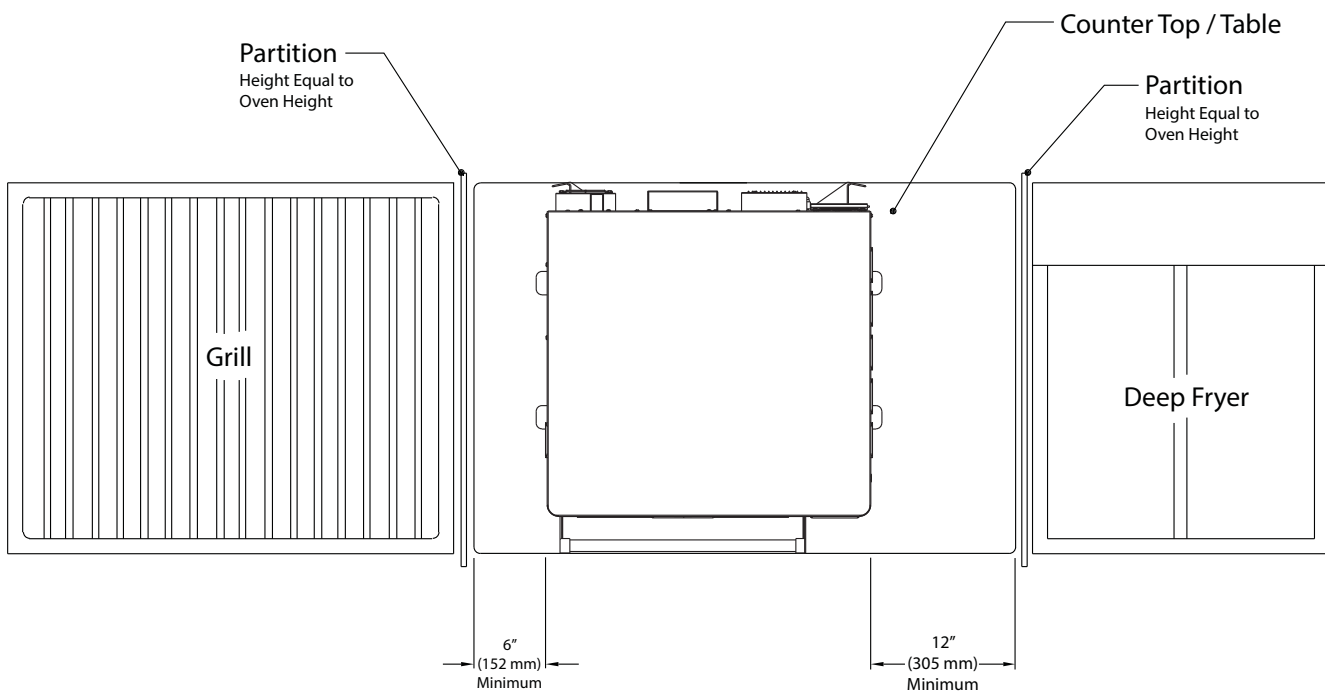

Figure 2: Installation Near Open Heat Source

Oven Restraint Kit

Part Number: [TC3-0242](#)



WARNING: The Oven Restraint Kit will not prevent the oven from falling off a countertop if the oven is pulled off or allowed to slide off the edge. Installation instructions are included with the kit.

TurboChef Connect™

TurboChef Connect™ allows you to remotely update the menu for ovens that are connected via WiFi. TurboChef Connect™ also includes reporting tools and live data streams to view what is being cooked and when. You can also receive alerts via email.

For more information, call TurboChef Customer Support at 800.90TURBO or +1 214.379.6000.

ChefComm Pro®

Part Number: [CON-7006](#)

ChefComm Pro® lets you easily create menu settings on a computer and upload them to an oven via USB. For more information, call TurboChef Customer Support at 800.90TURBO or +1 214.379.6000.

Date and Time Prompt

The oven maintains a data log that contains valuable information about the operation of the oven, including faults, items cooked, and other events. An accurate date and time are important for the data log. If the oven loses the date and time as a result of prolonged disconnection from power, a prompt will alert the operator to set the date and time. The prompt will only occur whenever power is cycled. If bypassed, the operator must update the date and time from the Info Mode Settings screen.

Voltage Selection

For North America oven models, the oven will detect 208 or 240 incoming voltage.

If incoming voltage for the store is different than the factory-preset voltage, the operator will be required to select either 208 or 240. The correct voltage will be highlighted on the screen, identifying which option to touch (see Figure 3 adjacent).



Figure 3: Selecting Voltage

Ventilation

The TurboChef Double Batch oven has been approved by Underwriter's Laboratory® for ventless operation (UL KNLZ listing) for all food items except for foods classified as "fatty raw proteins." Such foods include bone-in, skin-on chicken, raw hamburger meat, raw bacon, raw sausage, steaks, etc. If cooking these types of foods, consult local HVAC codes and authorities to ensure compliance with ventilation requirements.

To ensure continued compliance with all health, building, and fire codes, you are required to maintain clean and sanitary conditions around your oven at all times.

NOTE: In no event shall the manufacturer assume any liability for damages or injuries resulting from installations which are not in compliance with the instructions and codes previously listed. Failure to comply with these instructions could result in the issuance of a temporary cease and desist order from the local health department until the environment concerns are addressed.

Oven Maintenance

Daily Maintenance

The following steps will help maintain your oven. Use only TurboChef Oven Cleaner and Oven Guard. The use of any other cleaning products can damage critical oven components, resulting in a non-warranty service call.

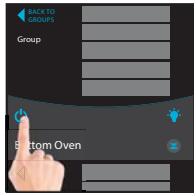

Step 1

Step 1: Prepare the Ovens

⚠ WARNING: The ovens operate at temperatures up to 550°F (285°C) and may cause injury if not allowed to cool properly.

- Turn both ovens off by touching the Off icons on the top oven and bottom oven screen.
- Open the oven doors.
- DO NOT attempt to clean until both oven displays no longer read “Cooling Down.”



Step 2

Step 2: Remove and Clean the Wire Racks (Top and Bottom Oven)

⚠ WARNING: Be sure the oven interior is cool before you remove the wire rack.

- Wash, rinse, and sanitize the wire racks.

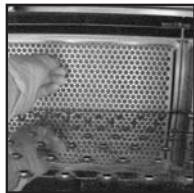

Step 3

Step 3: Remove and Clean the Grease Filters (Top and Bottom Oven)

- Lift the grease filter by the handle and pull forward.
- Wash and gently rinse the grease filters with hot water.

⚠ WARNING: DO NOT scrub the grease filter or use a water jet when cleaning.

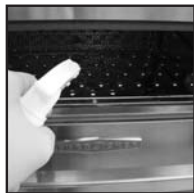

Step 4

Step 4: Clean the Cook Chambers (Top and Bottom Oven)

- Use a food vacuum or damp towel to remove food particles from the cook chambers.
- Spray oven cleaner onto the top, bottom, and sides of the oven interiors.

⚠ CAUTION: DO NOT spray Oven Cleaner into the holes on the back oven walls or directly onto the cook chamber lamps. Doing so can damage critical oven components, resulting in a non-warranty service call.

- For stubborn stains, spray Oven Cleaner and allow it to penetrate for 5 minutes.
- Clean the oven interiors with a nylon scrub pad.
- Wipe the cook chambers with a clean damp towel, and then a dry towel.



Step 5.1

Step 5: Clean the Oven Doors (Top and Bottom Oven)

- Clean the metal portion of the oven doors with Oven Cleaner and a nylon scrub pad.
- Gently clean the glass windows with Oven Cleaner and a cleaning towel.

⚠ CAUTION: DO NOT use abrasive cleaning supplies (e.g. steel wool) when cleaning the glass windows. Doing so may scratch the windows.

⚠ CAUTION: DO NOT apply excessive force when cleaning the glass windows. Breakage will result in a non-warranty service call.

- Wipe the doors and windows with a clean, damp towel and then a dry towel.



Step 5.2

⚠ CAUTION: DO NOT scrub or attempt to clean the oven door gasket (Figure Step 5.2). Doing so may cause the oven doors to mis-align, resulting in a non-warranty service call.

Supplies and Equipment

- TurboChef Oven Cleaner (Part Number: 103180)
- TurboChef Oven Guard (Part Number: 103181)
- Nylon scrub pad, cleaning towel, disposable gloves, protective eyewear, dust mask (optional)

Continued on Page 6...



Step 6

Step 6: Apply Oven Guard (Top and Bottom Oven)

- Spray Oven Guard onto a clean towel.
- Wipe the interior walls and the inside of the oven doors.

⚠ CAUTION: DO NOT spray Oven Guard into the holes on the back oven walls or directly onto the cook chamber lamps. Doing so can damage critical oven components, resulting in a non-warranty service call.



Step 7

Step 7: Reinstall the Grease Filters and Wire Racks (Top and Bottom Oven)

- There are notches on the rear right and left sides of the wire rack which fit over the pins on the sides of the cook chamber. The wire rack must be installed correctly to ensure proper oven operation.



Step 8

Step 8: Clean the Air Filter

⚠ CAUTION: TurboChef does not recognize blocked air vents as a warrantable claim. The filter must be cleaned regularly or replaced if damaged. During oven operation, the filter must remain in place at all times.

- Remove the air filter from the back of the oven.
- Rinse the air filter with hot water. DO NOT scrub the filter.
- Allow the air filter to dry completely.
- Reinstall the air filter.

⚠ CAUTION: DO NOT operate the oven without the filter in place.



Step 9

Step 9: Clean the Oven Exterior

- Wipe the oven exterior with a clean, damp towel.

⚠ CAUTION: DO NOT spray chemicals into any openings, such as the louvers on the side or rear panels. Doing so can damage critical oven components, resulting in a non-warranty service call.

- Wipe the oven exterior with a clean, dry towel.

Weekly Maintenance

Once a week (or more frequently depending on use), perform the following steps to help maintain your oven. Use only TurboChef Oven Cleaner and Oven Guard. The use of any other cleaning products can damage critical oven components, resulting in a non-warranty service call.

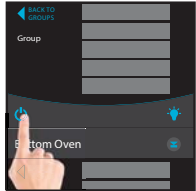

Step 1

Step 1: Prepare the Ovens

⚠ WARNING: The ovens operate at temperatures up to 550°F (285°C) and may cause injury if not allowed to cool properly.

- Turn both ovens off by touching the Off icons on the top oven and bottom oven screen.
- Open the oven doors.
- DO NOT attempt to clean until both oven displays no longer read “Cooling Down.”



Step 2

Step 2: Remove and Clean the Wire Racks (Top and Bottom Oven)

⚠ WARNING: Be sure the oven interior is cool before you remove the wire rack.

- Wash, rinse, and sanitize the wire racks.



Step 3

Step 3: Remove and Clean the Grease Filters (Top and Bottom Oven)

- Lift the grease filter by the handle and pull forward.
- Wash and gently rinse the grease filters with hot water.

⚠ WARNING: DO NOT scrub the grease filter or use a water jet when cleaning.



Step 4.1

Step 4: Remove and Clean the Bottom Jetplates (Top and Bottom Oven)

- Remove the left and right support rails by pulling up on the thumb screws and unscrewing them until there is enough clearance to remove the rail (Figure Step 4.1), and then gently pulling the rails out and away from the oven (Figure Step 4.2).
- Remove the bottom jetplate (Figure Step 4.3).
- Wash, rinse, and sanitize the bottom jetplate.

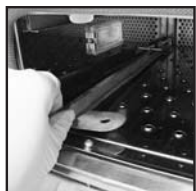

Step 4.2

Step 5: Clean the Cook Chambers (Top and Bottom Oven)

- Use a food vacuum or damp towel to remove food particles from the cook chambers.
- Spray oven cleaner onto the top, bottom, and sides of the oven interiors.

⚠ CAUTION: DO NOT spray Oven Cleaner into the holes on the back oven walls or directly onto the cook chamber lamps. Doing so can damage critical oven components, resulting in a non-warranty service call.

- For stubborn stains, spray Oven Cleaner and allow it to penetrate for 5 minutes.
- Clean the oven interiors with a nylon scrub pad.
- Wipe the cook chambers with a clean damp towel, and then a dry towel.



Step 4.3



Step 5

Continued on Page 8...

Supplies and Equipment

- TurboChef Oven Cleaner (Part Number: 103180)
- TurboChef Oven Guard (Part Number: 103181)
- Nylon scrub pad, cleaning towel, disposable gloves, protective eyewear, dust mask (optional)



Step 6.1

Step 6: Clean the Oven Doors (Top and Bottom Oven)

- Clean the metal portion of the oven doors with Oven Cleaner and a nylon scrub pad.
- Gently clean the glass windows with Oven Cleaner and a cleaning towel.

⚠ CAUTION: DO NOT use abrasive cleaning supplies (e.g. steel wool) when cleaning the glass windows. Doing so may scratch the windows.

⚠ CAUTION: DO NOT apply excessive force when cleaning the glass windows. Breakage will result in a non-warranty service call.

- Wipe the doors and windows with a clean, damp towel and then a dry towel.

⚠ CAUTION: DO NOT scrub or attempt to clean the oven door gasket (Figure *Step 6.2*). Doing so may cause the oven doors to mis-align, resulting in a non-warranty service call.

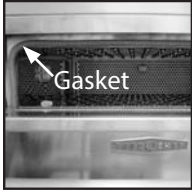

Step 6.2

Step 7: Apply Oven Guard (Top and Bottom Oven)

- Spray Oven Guard onto a clean towel.
- Wipe the interior walls and the inside of the oven doors.

⚠ CAUTION: DO NOT spray Oven Guard into the holes on the back oven walls or directly onto the cook chamber lamps. Doing so can damage critical oven components, resulting in a non-warranty service call.



Step 7

Step 8: Reinstall the Bottom Jetplates, Left and Right Support Rails, Grease Filters, and Wire Racks (Top and Bottom Oven)

- There are notches on the rear right and left sides of the wire rack which fit over the pins on the sides of the cook chamber. The wire rack must be installed correctly to ensure proper oven operation.



Step 8

Step 9: Clean the Air Filter

⚠ CAUTION: TurboChef does not recognize blocked air vents as a warrantable claim. The filter must be cleaned regularly or replaced if damaged. During oven operation, the filter must remain in place at all times.

- Remove the air filter from the back of the oven.
- Rinse the air filter with hot water. DO NOT scrub the filter.
- Allow the air filter to dry completely.
- Reinstall the air filter.

⚠ CAUTION: DO NOT operate the oven without the filter in place.



Step 9

Step 10: Clean the Oven Exterior

- Wipe the oven exterior with a clean, damp towel.

⚠ CAUTION: DO NOT spray chemicals into any openings, such as the louvers on the side or rear panels. Doing so can damage critical oven components, resulting in a non-warranty service call.

- Wipe the oven exterior with a clean, dry towel.



Step 10

Operating the Oven

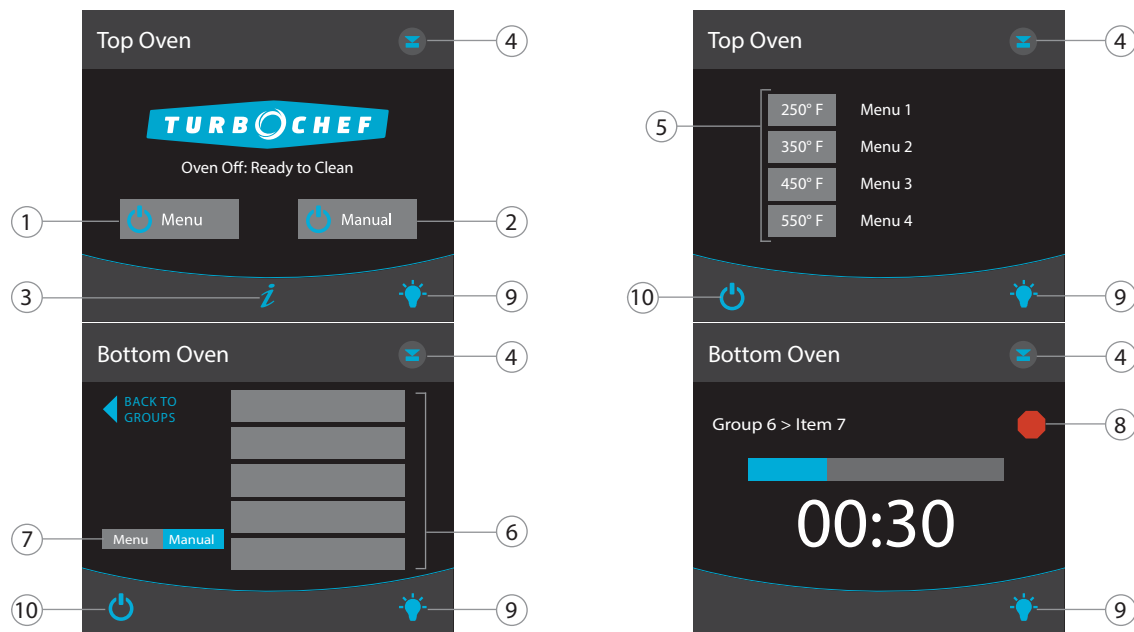

Figure 4: Oven Controls

NOTE: Display options vary depending on which features are enabled.

Oven Controls

The Double Batch's interface allows simultaneous control over both ovens. During standard operation, the top oven is controlled by the upper half of the screen and the bottom oven is controlled by the lower half. The user can expand the upper/lower interface to access more options when needed. When one oven interface is expanded, the other oven interface will be limited.

1. Menu Icon/Temperature Icon

Touch to turn the oven on and cook in Menu Cook Mode (page 10).

2. Manual Icon

Touch to turn the oven on and cook in Manual Cook Mode (page 12). The Manual icon is only present if enabled from the options screen (page 14).

3. "i" Icon

Touch to access Info Mode. The "i" icon is only displayed when both ovens are off or cooling down.

4. Expand/Collapse Icon

Touch to expand or collapse the controls for the top/bottom oven.

5. Menu Selection

The oven contains 8 menus. The top oven contains menus 1-4 and the bottom oven contains menus 5-8.

6. Groups/Items

Each menu contains 10 groups. Groups 1-5 are available from the standard operation screens. Expand the oven controls to access groups 6-10. Each food group contains 10 items divided into 2 groups of 5, the first 5 items are available from standard operation, expand the screen to access items 6-10.

7. Menu/Manual Toggle

The Menu/Manual toggle will only be displayed when manual cooking is enabled and will allow you to switch between menu mode (page 10) and manual mode (page 12).

8. Stop Icon

Touch to immediately terminate a cook cycle.

9. Light Icon

Touch to turn the oven light on and off for the top/bottom oven.

10. Off Icon

Touch to turn the oven off (cool down).

Menu Cook Mode

The oven is preprogrammed with recipe settings at the time of manufacture and is ready to operate out of the box. New menu settings can be loaded via USB or programmed manually. If settings are not present, the oven will cook only in manual mode (page 12).

The Double Batch oven uses impingement to create high heat transfer rates and reduce cook time. Air enters the cavity from the top and bottom and is distributed by the jetplates. Because of this design and to ensure uniformity of cooking, the top and bottom jetplates must be installed during operation.

The sequence of the steps below may vary and some may not apply.

Step 1: Touch the “Menu” Icon to Turn the Oven On and Select a Temperature

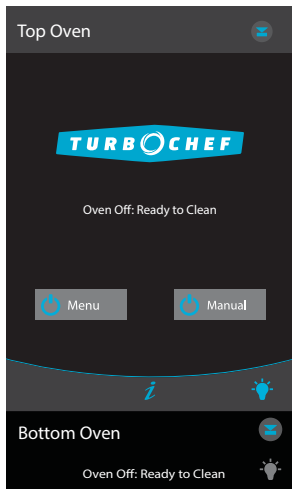

Step 2: Select a Menu

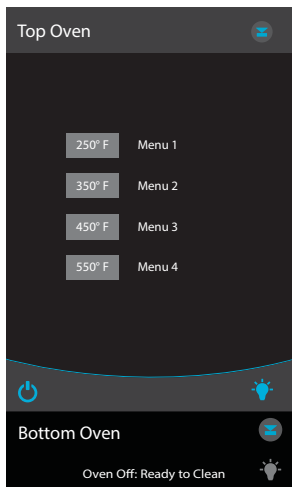

Step 3: Warming Up

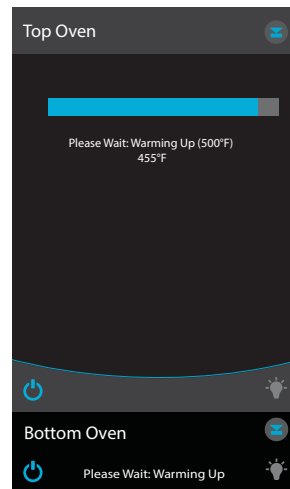

NOTE: When the oven is done warming up, it will “soak” for an additional eight minutes. “Soaking” ensures the cavity surfaces absorb enough heat so that cooking will not be affected.

Step 4: Place Food in the Oven

⚠️ WARNING: Inside of ovens and oven doors are hot!

Step 5: Select a Group

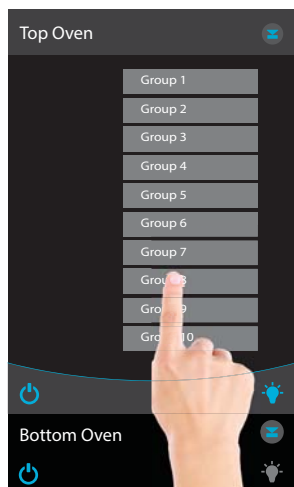

NOTE: Touch the Expand/Collapse icon to access additional groups.

Step 8: Check/Remove Food from Oven

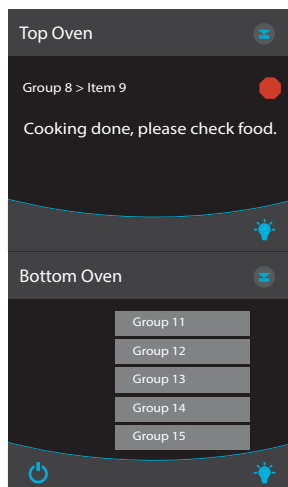

⚠ WARNING: Dish/inside of oven and door is hot!

Step 6: Select an Item

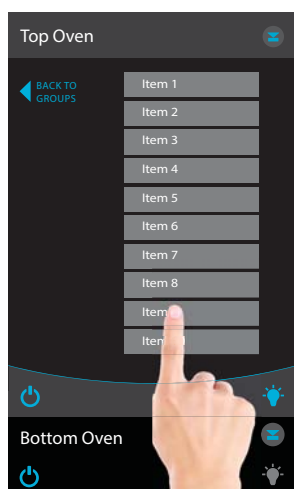

NOTE: Touch the Expand/Collapse icon to access additional items.

Step 9: Cook More

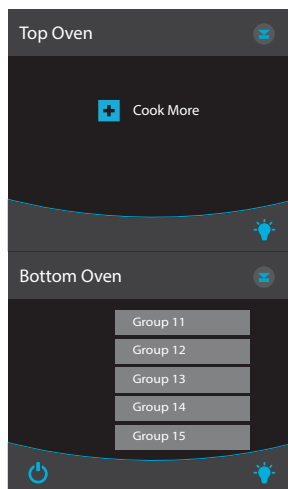

NOTE: This option must be enabled from the Options Screen (page 14) in order to cook an item beyond its original cook time.

Touch “Cook More” to cook the item for 20% longer with 100% air.

Step 7: Cooking

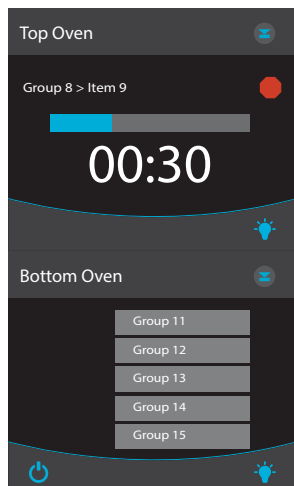

NOTE: To immediately terminate a cook cycle, touch the red “STOP” icon.

NOTE: If the oven door is opened during a cook cycle, the cycle will pause until the door is closed.

Step 10: Cooling Down

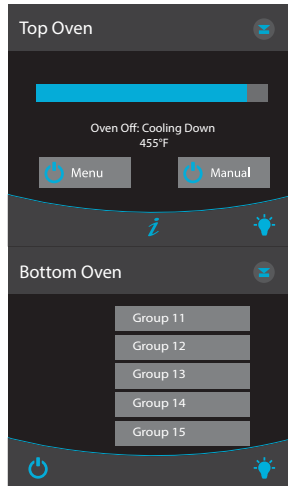

When finished cooking for the day, touch “OFF” to begin cooling down.





Manual Cook Mode

Manual Cook Mode is intended for professionals, and allows cooking “on the fly,” whereas Menu Cook Mode (page 10) allows cooking from preset cook settings. Some oven versions also allow holding temperatures. To access Manual Cook Mode, touch the Manual icon when the oven is off or cooling down (page 11) or touch the Menu/Manual toggle on the Menu Mode screen. Manual Cooking can be enabled and disabled from the Options Screen (page 14).

To cook or hold an item in Manual Cook Mode, adjust the settings using the icons on the screen, allow the oven to warm or cool to the set temperature, and touch the cook icon.





1. % Air

% Air determines the amount of airflow. The more air, the more the product will brown or crisp. % Air can be set from 10-100% or 0-100% via four icons:

-  Reset the air to 10% or 0%
-  Add 5%
-  Add 10%
-  Add 25%

2. Cook Time

Time can be set from 00:05-99:55 (mm:ss). There are four time icons.

-  Clear (or “zero”) the time
-  Add 5 seconds
-  Add 30 seconds
-  Add 60 seconds

3. Set Temperature

Touch to change the set temperature. The temperature range is 300–550°F in 25°F increments (150–285°C in 10-15°C increments) or 150-550°F in 10°F increments (65–285°C in 5-10°C increments).

4. Cook

Touch to cook (not necessary if holding).

NOTE: The oven may require additional warming time.

5. Off Icon

Touch to turn the oven off (cool down).

6. Menu/Manual Toggle

Switch between Menu Cook Mode (page 10) and Manual Cook Mode.

7. Expand/Collapse Icon

Touch to expand or collapse the controls for the top/bottom oven.

8. Light Icon

Touch to turn the oven light on and off for the top/bottom oven.

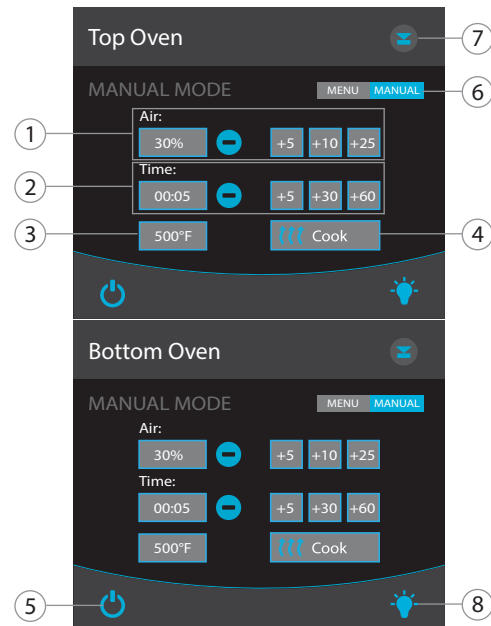

Figure 5: Manual Cook Mode

Info Mode

To access Info Mode, touch the “i” icon when both ovens are off or cooling down. From the Info Mode screen (Figure 6), access:

- Information screen
- Counters screen
- Options screen
- Settings screen
- Service mode
- MFG mode

To access each screen, touch the corresponding icon (e.g. touch “COUNTERS” to access the Counters screen).

The Options, Settings, Service, and MFG screens require a passcode to access. Touch “Login” and when prompted, input the password 9 4 2 8 and touch the check icon in the bottom-right corner of the screen (Figure 7).

Information Screen

From the Information screen (Figure 8), view:

- Serial Number
- Menu Version
- Sage Firmware Version
- Phoenix Firmware Version
- Service Number
- Language
- VAC (Voltage Setting) - View Incoming

Counters Screen

From the Counters screen (Figure 9), view:

- Cook Counter
- Total Cook Time in cumulative hours
- Total Time (oven on) in cumulative hours
- Power Cycles: The number of times the oven has cycled power.
- Erase Counters (option available while logged in)
- Fault Log

Counters Screen - Fault Log

The fault log is split into the “Count” screen and the “History” screen.

Count Screen: Displays the number of times a fault has occurred (Figure 10).

History Screen: Displays the timestamp of each fault occurrence (Figure 11).

Touch the “COUNT” / “HISTORY” toggle on the left-side of the screen to switch between these screens.

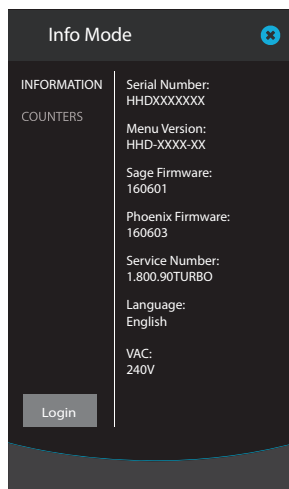

Figure 6: Info Mode

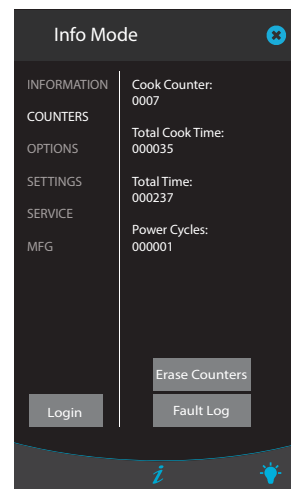

Figure 9: Counters Screen

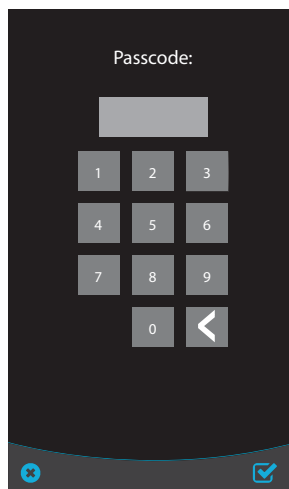

Figure 7: Passcode Screen

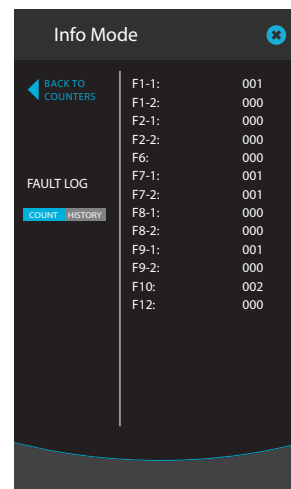

Figure 10: Fault Log - Count



Figure 8: Information Screen

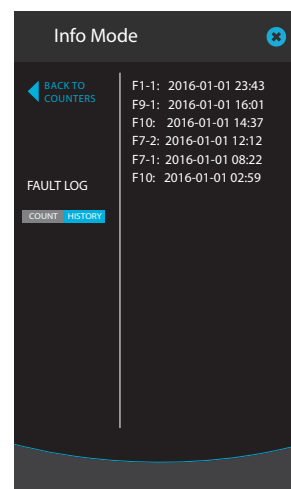

Figure 11: Fault Log - History

Options Screen

From the options screen (Figure 12), enable/disable:

- Editing
- Cook More
- Load Menu
- VAC
- Demo Mode
- Manual Cooking
- Diagnostic Mode
- F2 Bypass

You must enter the passcode 9 4 2 8 to access this screen, see page 13 for more details.

Options Screen - Editing

This toggle changes the oven between standard Menu Mode and Edit Mode. For more information on Edit Mode, see page 16.

Options Screen - Cook More

Cook More controls whether or not the “Cook More” option appears when a cook cycle is done. This option must be enabled in order to cook an item beyond its original cook time. See page 11 for details.

Options Screen - Load Menu

Load Menu enables or disables the “load menu” option on the USB detection screen. See page 18 for more details.

Options Screen - VAC Setting

When VAC is set to YES the incoming voltage setting will be displayed on the Info screen. This is set by the factory and should not be changed.

Options Screen - Demo Mode

Demo Mode is a feature used to demonstrate the cooking features of the oven without turning on the heaters or microwave system. Demo Mode must be set to NO during regular operation.

Options Screen - Manual Cooking

When Manual Cooking is set to YES, the operator can cook items “on the fly.” See page 12 for more details.

Options Screen - Diagnostic Mode

Diagnostic Mode allows service technicians to view and test oven components. Diagnostic Mode should be set to NO during regular operation.

Options Screen - F2 Bypass

If F2 Bypass is set to YES, the oven will log an F2 fault condition should one occur, but it will not terminate a cook cycle. If F2 bypass is set to NO, then the oven will terminate a cook cycle upon discovery of an F2 fault condition.

Settings Screen

You must enter the passcode 9 4 2 8 to access this screen; see page 13 for more details.

Settings Screen - Temperature Measurement

The temperature measurement setting is configured at the factory. Touch the toggle to change between °F (Fahrenheit) and °C (Celsius).

Settings Screen - Phase

The phase setting is configured at the factory. Touch the toggle to change between Single and Multi. NOTE: changing this setting will affect oven cooking performance!

Settings Screen - Language

The default language is English. To change to another language, touch “Language: English” and then touch the preferred language and touch “ENTER.”

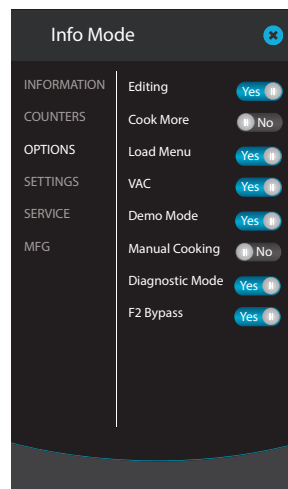

Figure 12: Options Screen

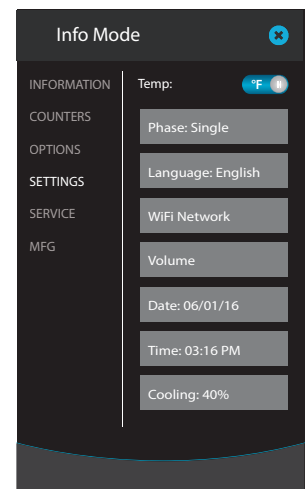

Figure 13: Settings Screen

Settings Screen - WiFi Network

Connecting the oven to a WiFi network and utilizing TurboChef's connectivity service (TurboChef Connect) allows you to remotely update the menu for one or all of your ovens and enables access to reporting tools and live data streams to view what is being cooked and when. TurboChef Connect also allows you to receive alerts via email.

Special instructions for corporate/chain customers may be required. Contact your facility administrator for more information.

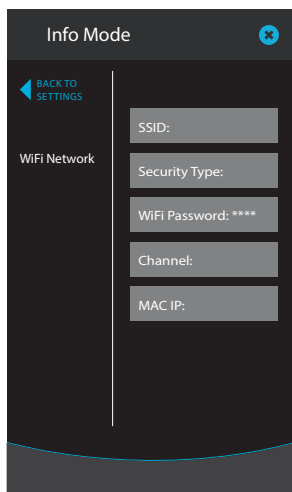

Figure 14: WiFi Screen

SSID

The SSID is the case-sensitive name of the WiFi network that the oven will join. After touching the SSID icon, use the on-screen keyboard to type in the WiFi network name and touch the check icon in the bottom-right corner of the screen.

If you are unsure of the SSID for the network, contact your network administrator. In some instances, the SSID may be printed on a label on the bottom of your WiFi router.

Security Type

The Security Type is set by your WiFi router. After touching "Security Type," select the security type being used by your router: Open, WPA, WPA2, WEP.

After selecting the correct Security Type, touch the check icon in the bottom-right corner of the screen.

If you are unsure of the Security Type being used by the network, contact your network administrator. In some instances, the Security Type may be printed on a label on the bottom of your WiFi router.

WiFi Password

The WiFi Password is the case sensitive password needed to join the WiFi network. After touching the WiFi Password icon, use the on-screen keyboard to type in the WiFi network password and touch the check icon in the bottom-right corner of the screen.

If you are unsure of the WiFi Password for the network, contact your network administrator. In some instances, the WiFi Password may be printed on a label on the bottom of your WiFi router.

NOTE: "Open" networks do not use WiFi passwords. Clear or leave this field empty when using the oven on an "Open" network. Additional permissions at the router may be required for use on open networks. Contact your network administrator for assistance.

Channel

The Channel is reported by the WiFi router. It is not changeable on the oven.

NOTE: If you are experiencing connectivity problems, TurboChef recommends setting the WiFi router's channel to 1.

Change the network channel by logging into your router. For help with your WiFi router, contact your network administrator.

MAC IP

The MAC IP is automatically assigned to the embedded wireless device. A visible MAC IP confirms the module is installed properly.

Settings Screen - Volume

Touch "Volume" and use the plus or minus icons to increase or decrease the volume of the oven's beeper. See Figure 13, page 14.

Settings Screen - Date

An accurate date is necessary for ensuring the accuracy of diagnostics and fault condition reporting on the oven.

NOTE: The oven may not retain the date if left unplugged for a prolonged period of time.

To set the date, touch "Date" and enter the date in the following format - MM/DD/YY. Touch the check icon in the bottom-right corner of the screen to save the changes. See Figure 13, page 14.

Settings Screen - Time

An accurate time is necessary for ensuring the accuracy of diagnostics and fault condition reporting.

NOTE: The oven may not retain the time if left unplugged for a prolonged period of time.

NOTE: The clock will not automatically update for Daylight savings time.

To set the time, touch “Time” and enter the time in 24-hour format (8:30 p.m. = 20:30). Touch the check icon in the bottom-right corner of the screen to save the changes. See Figure 13, page 14.

Settings Screen - Cooling

Touch “Cooling” to increase the cooling fan speed in 5% increments (from 30%-80%) during “Cooling Down” (Page 11). See Figure 13, page 14.

Service Screen

The Service screen allows technicians to test oven components:

- Top Blower: 10-100% in 5% increments
- Top Heater A: One heater element in the top oven
- Top Heater B: One heater element in the top oven
- Top Rack OS: Top oven rack motor
- Bottom Blower: 10-100% in 5% increments
- Bottom Heater A: One heater element in the bottom oven
- Bottom Heater B: One heater element in the bottom oven
- Bottom Rack OS: Bottom oven rack motor

NOTE: From the Service screen, the heaters are “full on,” meaning there is no modulation. To protect the circuit from an over-current condition, only two heaters are allowed to be turned on at the same time. If a third heater is turned on, the Service screen will automatically turn off the first heater that was selected to run.

Status Indicators

Indicators per cavity:

- D: Door open (backlit) / closed (not backlit)
- H/H: Heater off (backlit) / on (not backlit)
- A: Blower off (backlit) / on (not backlit)

MFG Screen

The MFG will allow you to change oven models (if applicable) or input the oven serial number.

Edit Mode

Edit Mode allows the operator to:

- Edit the set temperatures
- Edit item settings, group names, and item names

Editing can be enabled and disabled from the Options screen (page 14).

NOTE: Top and bottom oven settings are independent of each other. To change the top oven temperature and menu settings, use the upper half of the screen. To change the bottom oven temperature and menu settings, use the bottom half of the screen.

Edit Set Temperature

See Figure 15, page 17. The menu set temperature should not be changed on the fly to compensate for over-cooking or under-cooking. If recipe settings are not cooking as desired, consult your menu developer or authorized distributor.

The set temperature can be edited in the group select screen (Figure 15, Page 17). Touch the temperature icon to increase the Set Temperature by 25°F (15°C). The temperature range is 300–550°F (150–285°C).

Edit Item Settings and Menu/Group/Item Names

See Figure 17, page 17. To edit settings, menu names, group names, and item names, select a group (Figure 15, page 17) and item (Figure 16, page 17) to edit.

NOTE: Some models may not include multi-temperature/menu selection.

1. Menu/Group/Item Name

From the Edit Item Settings Screen, the menu, group, and item names are only visible if the screen is in the expanded view. Compare Figure 17 to Figure 19. Touch the field you wish to edit and use the onscreen keyboard (Figure 18, page 17) to rename it.

NOTE: Touch the  icon to change the letter case.

NOTE: Touch the ALT icon to access special characters.

NOTE: Touch the &% icon to access symbols.

2. Event %Time

Each item can have up to four events. To set the amount of time for each event, touch the  icon that contains the percentage you wish to change. The time can be set from 0-100% (in 5% increments) for each event.

NOTE: The sum of all events must be 100; otherwise the oven will not allow the changes to be saved.

3. Event %Air

To set the amount of airflow used in each event, touch the  icon that contains the percentage you wish to change. The airflow can be set from 10-100% (in 5% increments) for each event.

4. Increase and Decrease





Touch these icons to increase or decrease the selected %Air or %Time events in 5% increments.

5. Total Cook Time

Displays the total cook time for the item.

6. Set Cook Time Icons

Time can be set from 00:05-99:55 (mm:ss). There are four time icons.

-  Clear (or “zero”) the time
-  Add 5 seconds
-  Add 30 seconds
-  Add 60 seconds

7. Cancel

Touch this icon to cancel all changes made to this item and return to the item select screen.

8. Save

Touch this icon to save all changes made to this item and return to the item select screen.

NOTE: While test cooking and developing your recipe settings, it is not necessary to save changes until you are ready to exit the edit recipe screen.

9. Cook

Touch this icon to perform a test cook using the settings displayed on the screen.

NOTE: You may have to allow the oven to cool down or warm up to the set temperature.



Figure 15: Edit Mode, Group Select/Temperature Edit

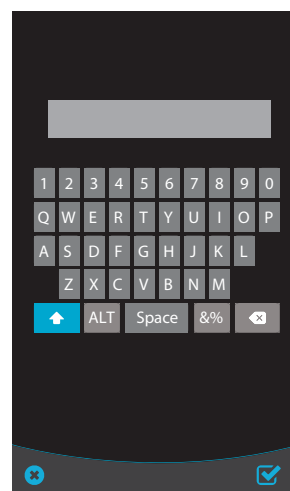

Figure 18: On-Screen Keyboard

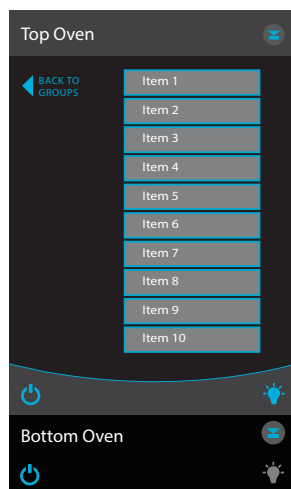

Figure 16: Edit Mode, Item Select



Figure 19: Edit Mode, Item Settings - Normal

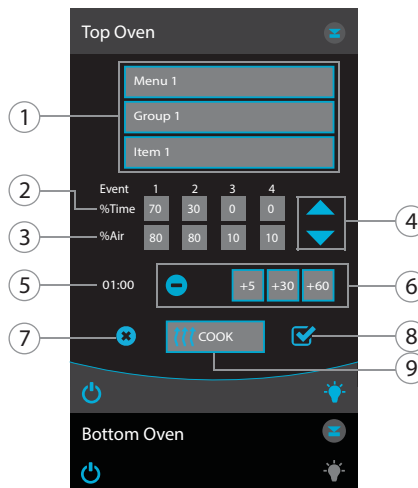

Figure 17: Edit Mode, Item Settings - Expanded

Loading and Saving Menus

NOTE: To load or save a menu, you may need to verify that access to the Load Menu option is turned on. See page 14 for details.

When loading a menu from USB, the menu must be in the BIN (binary) format and the files must be loaded on the root of the USB.

To create a BIN (binary) formatted menu,

1. Using ChefComm, load or create the menu on your computer.
2. Select Oven > Data Transfer > Create Oven (BIN) File. If this option is not available in ChefComm, select File > Save As and select .BIN as the file type.
3. Navigate to where you wish to save the menu.

NOTE: If you are saving the menu to a USB drive and you will use that USB drive to load the menu to the oven, you must save the menu to the root (top level) of the USB drive.

4. Name the file.

NOTE: If your version of ChefComm Pro is lacking these features, contact TurboChef Customer Support to obtain an update..

To load a menu to the oven,

1. When the oven is off or cooling down, insert the USB drive (Figure 20). The oven will automatically detect the device.
2. Touch “Load Menu to Oven” to proceed.
3. If more than one menu is on the USB drive, you will be prompted to pick which menu to load.

To save a menu to a USB drive,

1. When the oven is off or cooling down, insert the USB drive (Figure 20). The oven will automatically detect the device.
2. Touch “Save Menu to USB” to proceed.

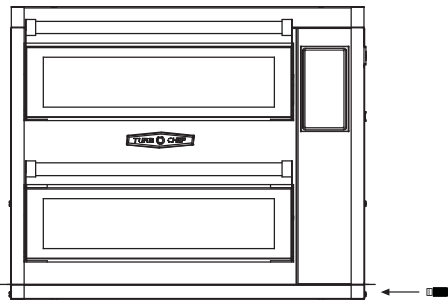

Figure 20: USB Port

Troubleshooting

Overview of Troubleshooting

This section contains information on the following:

- Fault code descriptions
- Fault code troubleshooting
- Non-fault code troubleshooting

For information on accessing the service screen, see page 16. For information and illustrations on replacing components, see the Appendix.

Fault Code Descriptions

To view the fault log, see page 13.

F1-1/F1-2: Blower Running Status Bad

This fault is displayed when the motor controller indicates no running status.

The motor and motor controller are monitored continuously in all modes with special handling on the Service Screen (page 16). If a fault is detected, the oven will stop cooking and go to the “Cooling Down” screen and flash “F1-1: Blower” or “F1-2: Blower”

Upon turning on the oven, the control will attempt to restart the motor. If the restart is successful, the fault message will be cleared from the display. The fault message is also cleared at the onset of cooking or when the blower motor is tested on the Service Screen (page 16).

F1-1 indicates a problem with the top oven.

F1-2 indicates a problem with the bottom oven.

F2-1/F2-2: Cook Temperature Low

This fault is displayed if the cook cavity temperature drops more than 120°F (67°C) below the set temperature during a cook cycle (registered after five seconds into a cook cycle).

The fault is cleared from the display at the onset of cooking if the cook cavity temperature is within 120°F (67°C) of the set temperature or when the heaters are tested on the Service Screen (page 16).

F2-1 indicates a problem with the top oven.

F2-2 indicates a problem with the bottom oven.

F6: Electrical Compartment Temperature High

This fault is displayed when the electrical compartment temperature exceeds 158°F (70°C), measured by a sensor on the control board. The electrical compartment temperature is monitored once per minute.

The fault is cleared from the display if on the next check, the temperature is below 158°F (70°C).

NOTE: The fault will be logged at 149°F (65°C), but it will not interrupt cooking at the lower threshold.

F7-1/F7-2: RTD Open

This fault is displayed when the control detects that one or both of the RTDs is “open.” The display will show “999°” indicating the RTD is open or disconnected. The fault is cleared when the control detects continuity.

F7-1 indicates a problem with the top oven.

F7-2 indicates a problem with the bottom oven.

F8-1/F8-2: Heat Low

This fault displays when the oven is warming up or on the Service Screen (page 16) if the cook cavity temperature fails to rise at least 14°F (7°C) within a given 30 seconds.

F8-1 indicates a problem with the top oven.

F8-2 indicates a problem with the bottom oven.

F9-1/F9-2: Cook Cavity Temperature High

This fault will signal that the catalyst has “flashed” due to excessive grease. The fault occurs when the RTD senses +650°F (343°C) for more than 40 seconds but less than 2 minutes. The fault will only appear in the fault log and will not terminate a cook cycle upon discovery.

F9-1 indicates a problem with the top oven.

F9-2 indicates a problem with the bottom oven.

F10: Communication Failure

This fault will signal that the UI control board (Phoenix) is no longer able to communicate with the I/O control board (SAGE). This fault will terminate a cook cycle upon discovery.

F12: Firmware Reboot

This fault will signal that the UI control board (Phoenix) became unresponsive for four seconds, forcing a system reboot.

Fault Code and Description	When Active				Refer to...
	Warmup	Idle	Cooking	Service Screen	
F1-1/F1-2: Blower	✓	✓	✓	✓	Page 21
F2-1/F2-2: Cook Temperature Low			✓		Page 22
F6: EC Temperature High	✓	✓	✓	✓	Page 23
F7-1/F7-2: RTD Open	✓	✓	✓	✓	Page 24
F8-1/F8-2: Heat Low	✓			✓	Page 25
F9-1/F9-2: Cavity Temp High			✓	✓	Page 26
F10: Communication Failure	✓	✓	✓	✓	Page 27
F12: Firmware Reboot	✓	✓	✓	✓	Page 28

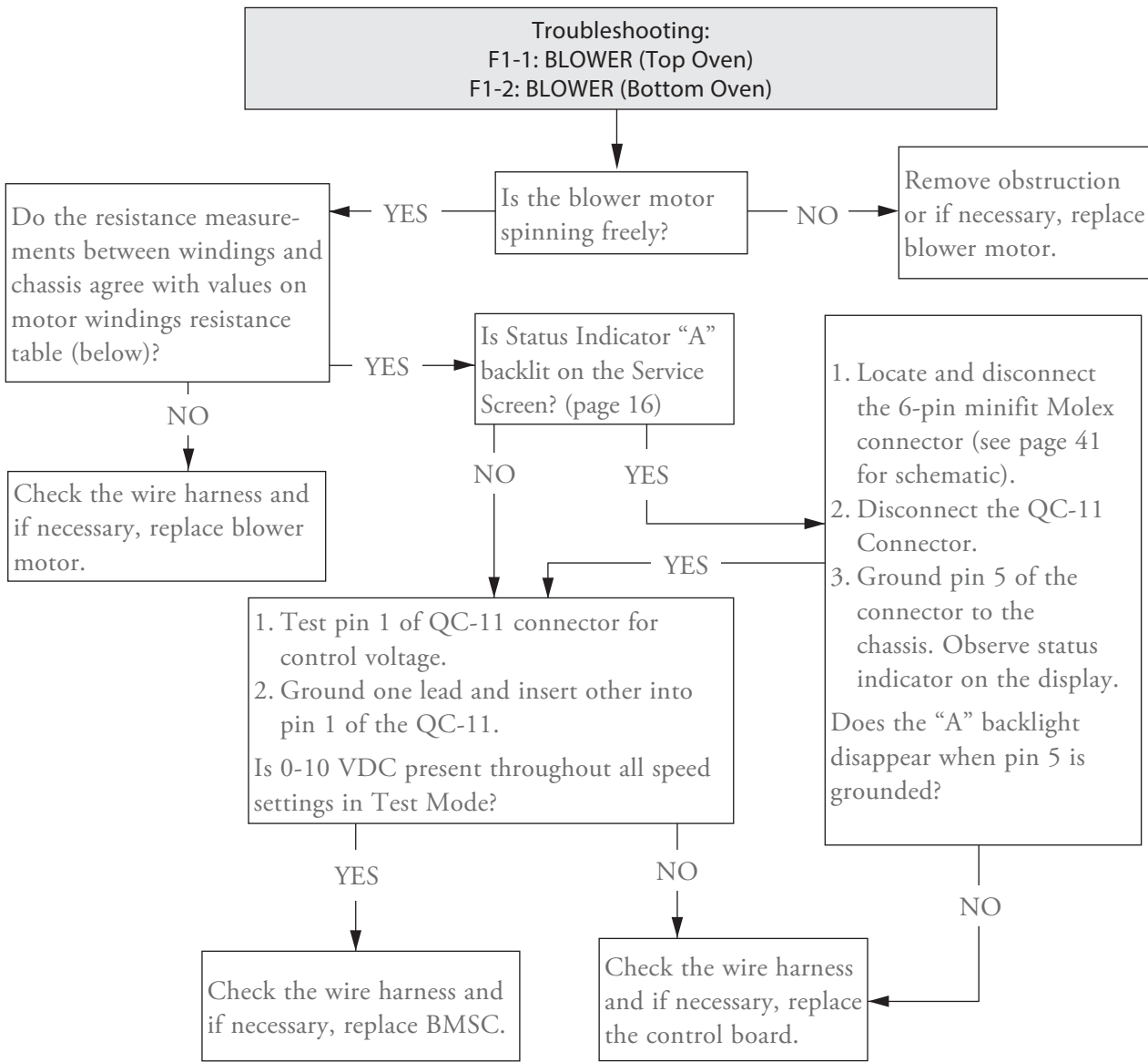

To	From	Description	Expected Resistance
Black	Red	Winding (A-B)	2.0-2.6 Ohms
Black	White	Winding (A-C)	2.0-2.6 Ohms
Red	White	Winding (B-C)	2.0-2.6 Ohms
Black, Red or White	Green	Windings to Chassis	Open

Figure 21: Motor Windings Resistance Table

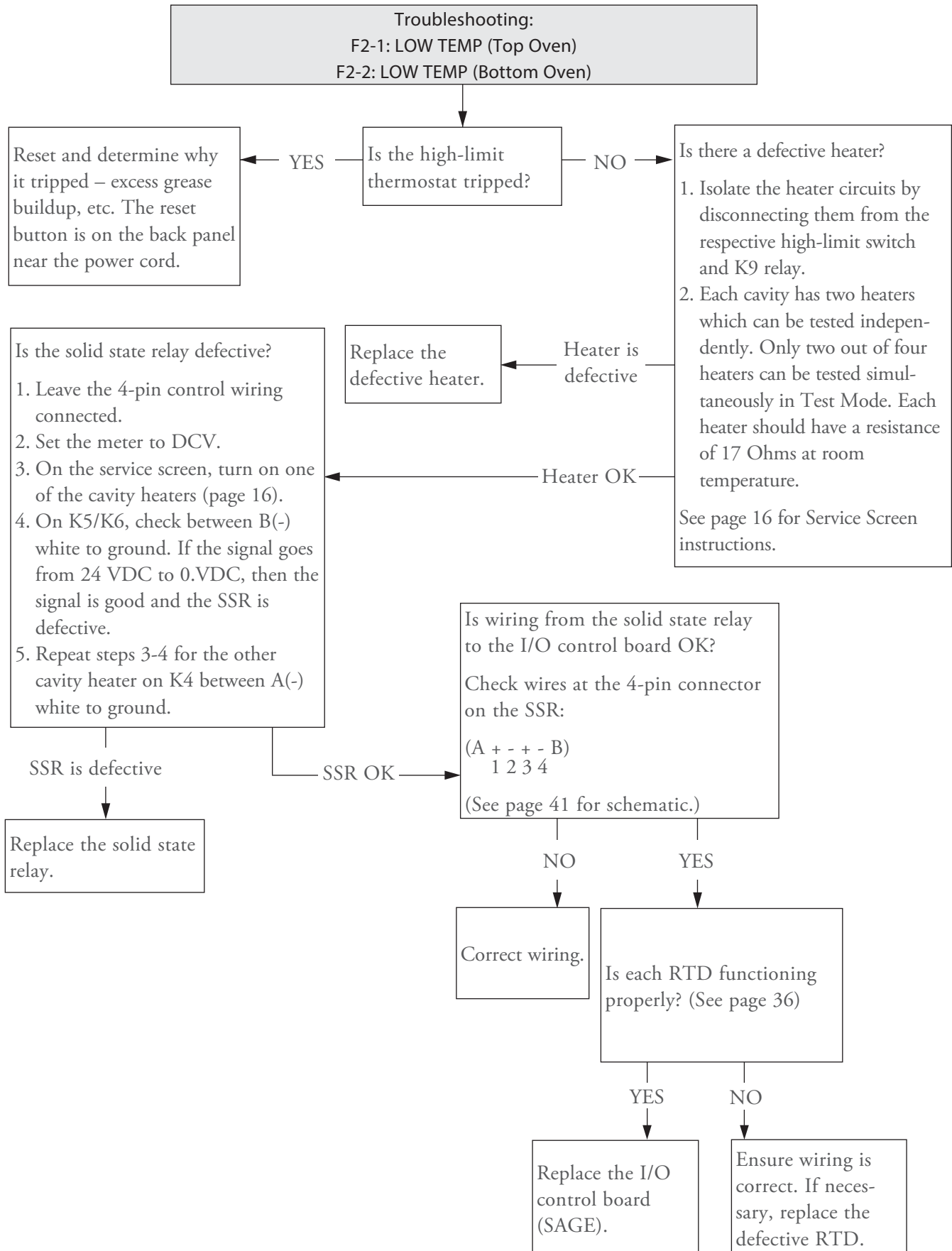

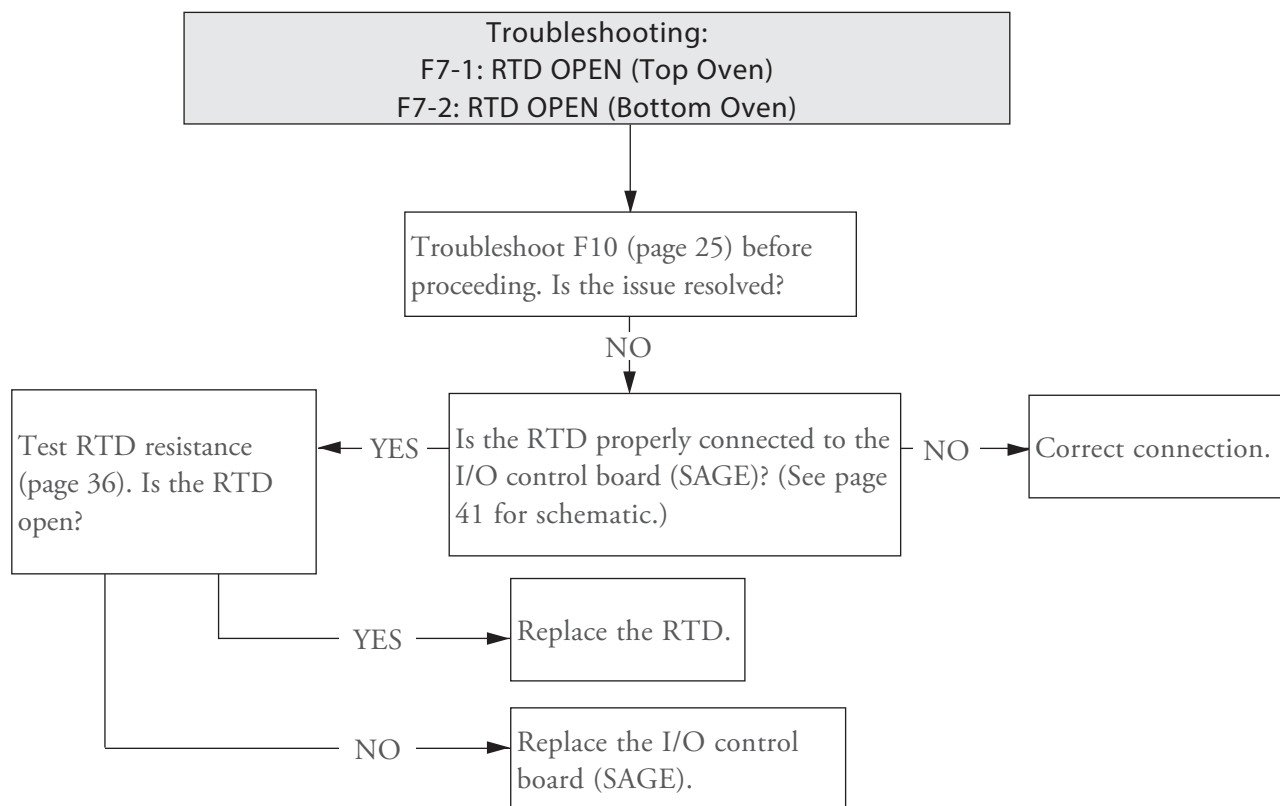
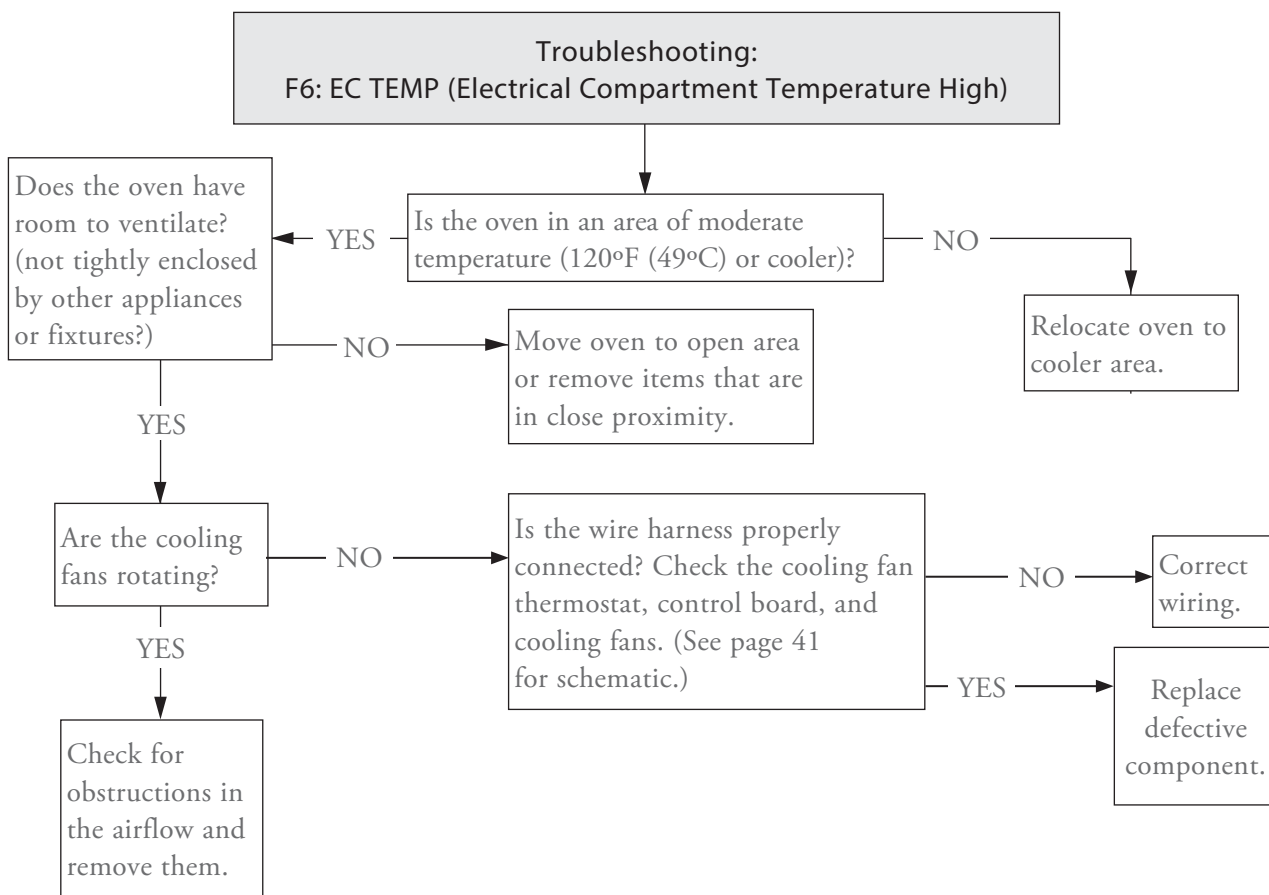

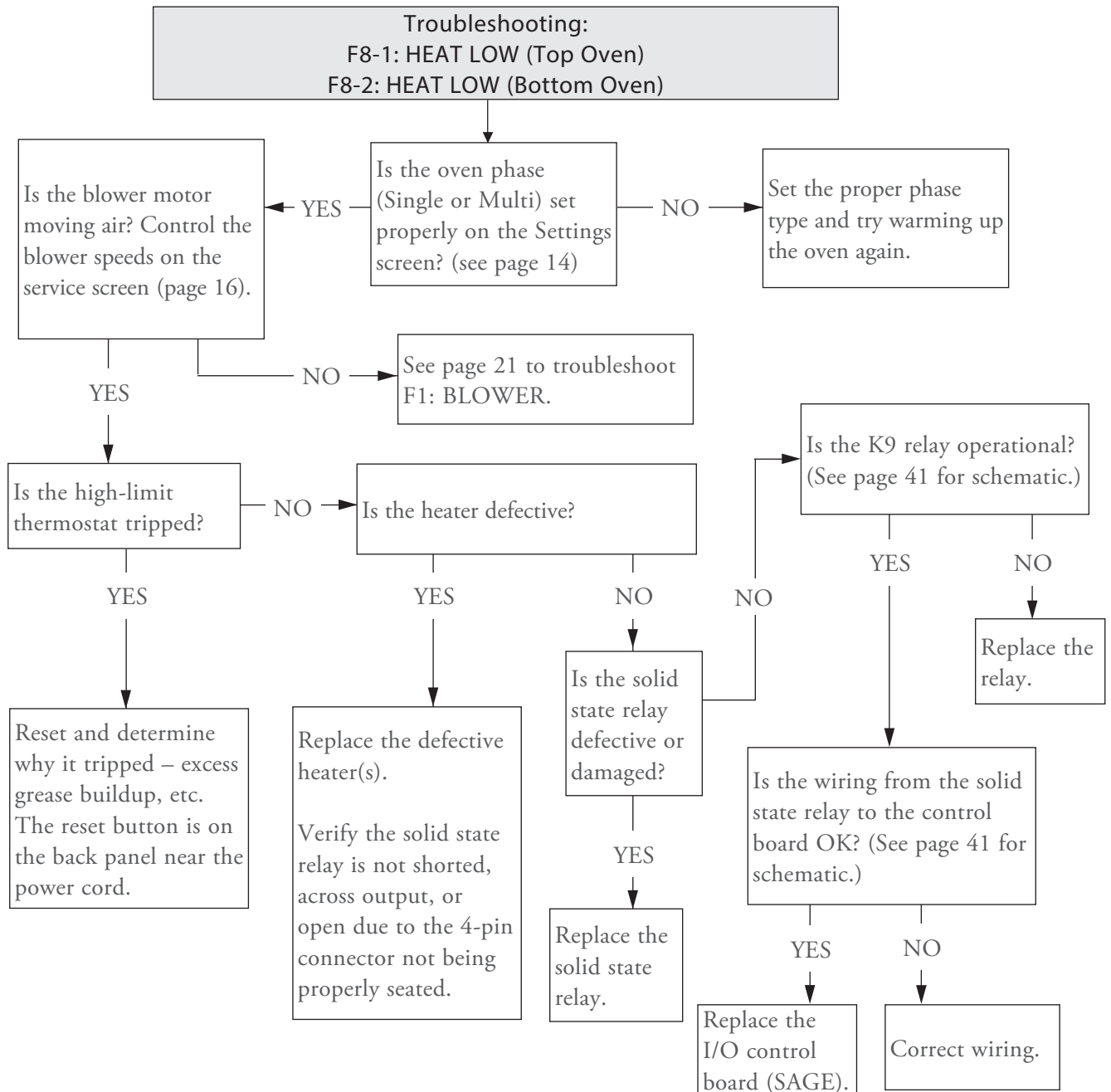

Troubleshooting:
F9-1: CC TEMP HIGH (Top Oven)
F9-2: CC TEMP HIGH (Bottom Oven)

If this fault frequently occurs,

- Ensure the oven is cleaned daily (see pages 5-8).
- Determine if large amounts of grease-laden food are being cooked, and if so, recommend smaller portions per cook cycle.

Troubleshooting:
F10: Communication Failure

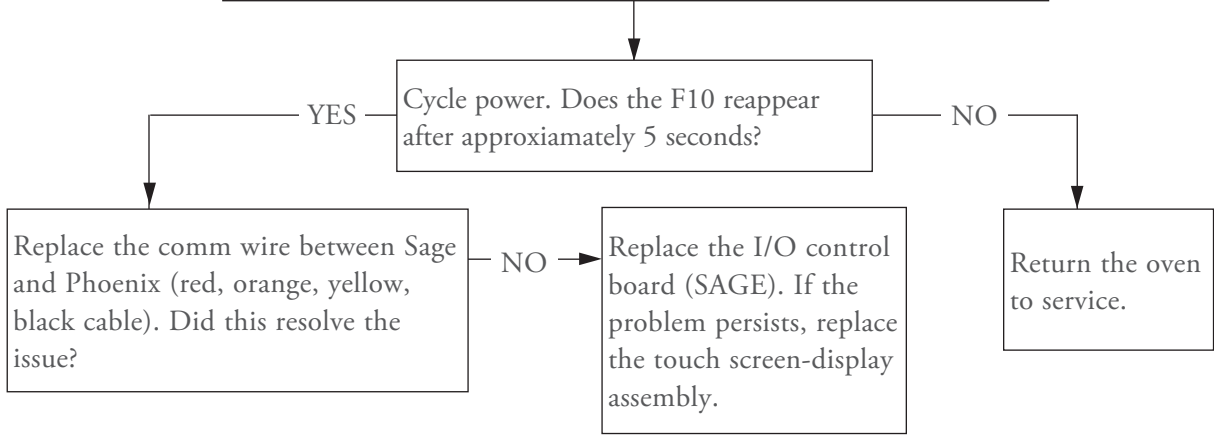

Troubleshooting:
F12: Firmware Reboot

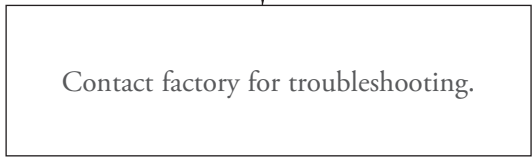

Non-Fault Code Troubleshooting

This section provides troubleshooting tips for issues that may occur independently of an oven fault.

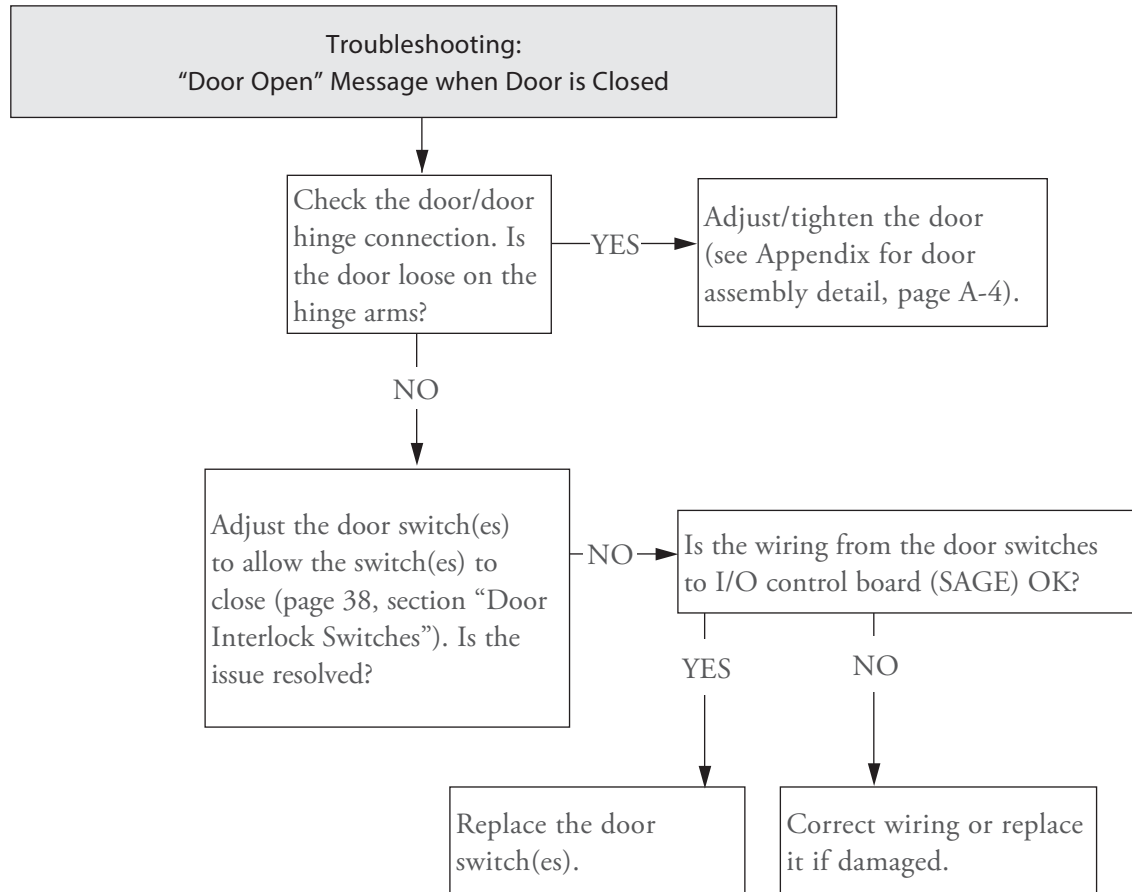

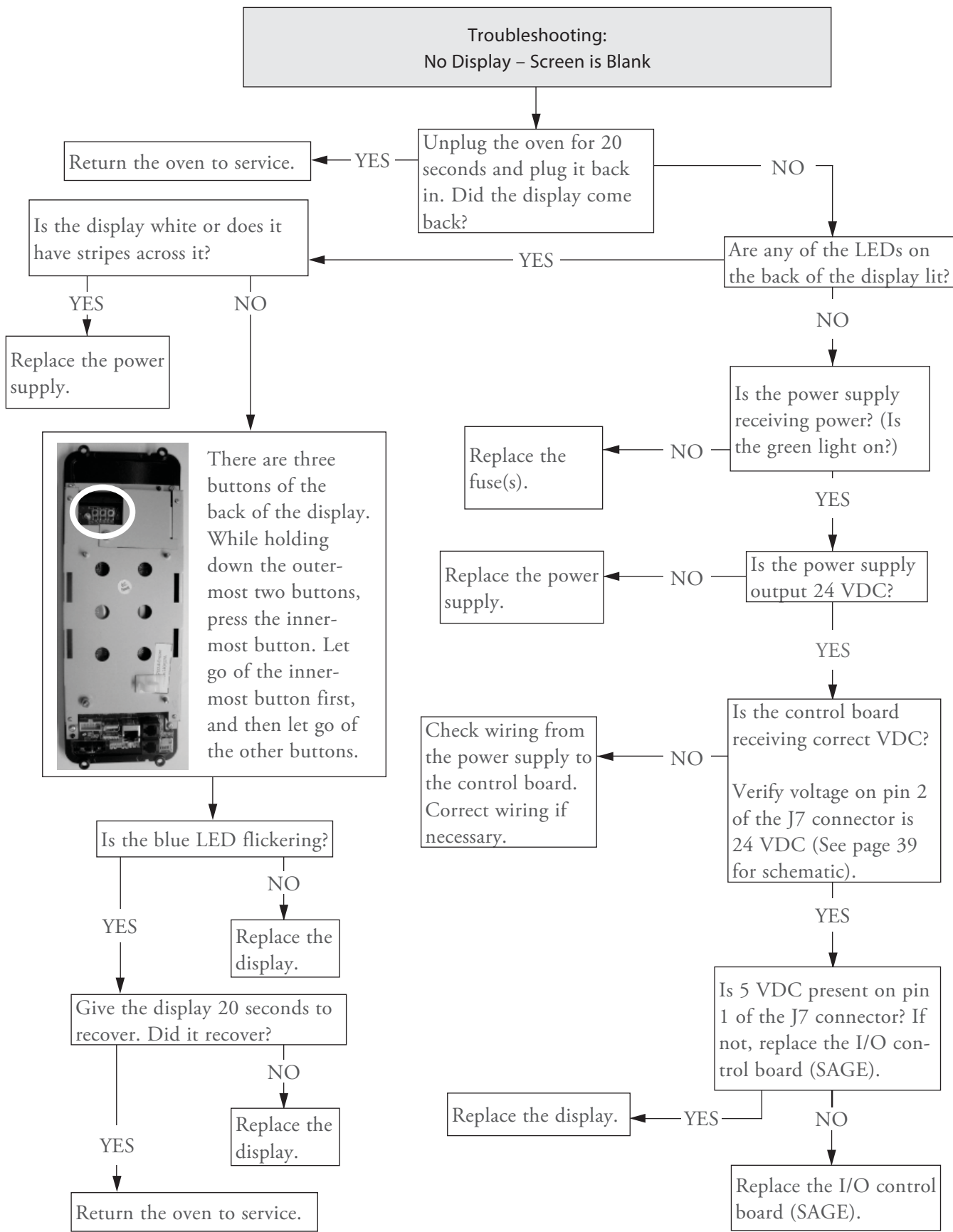

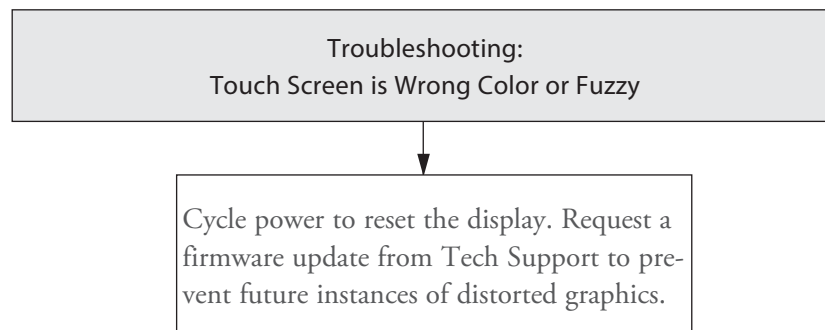
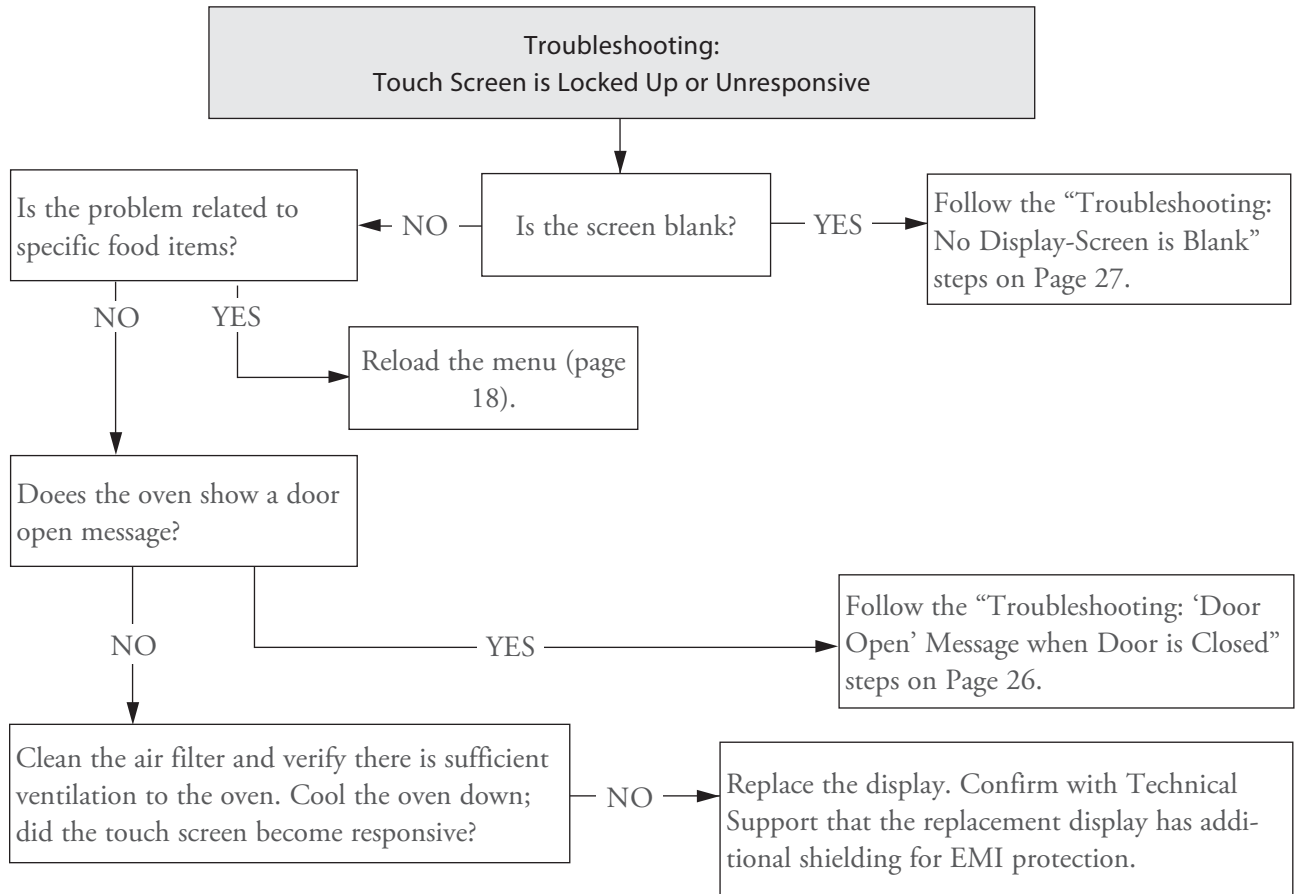

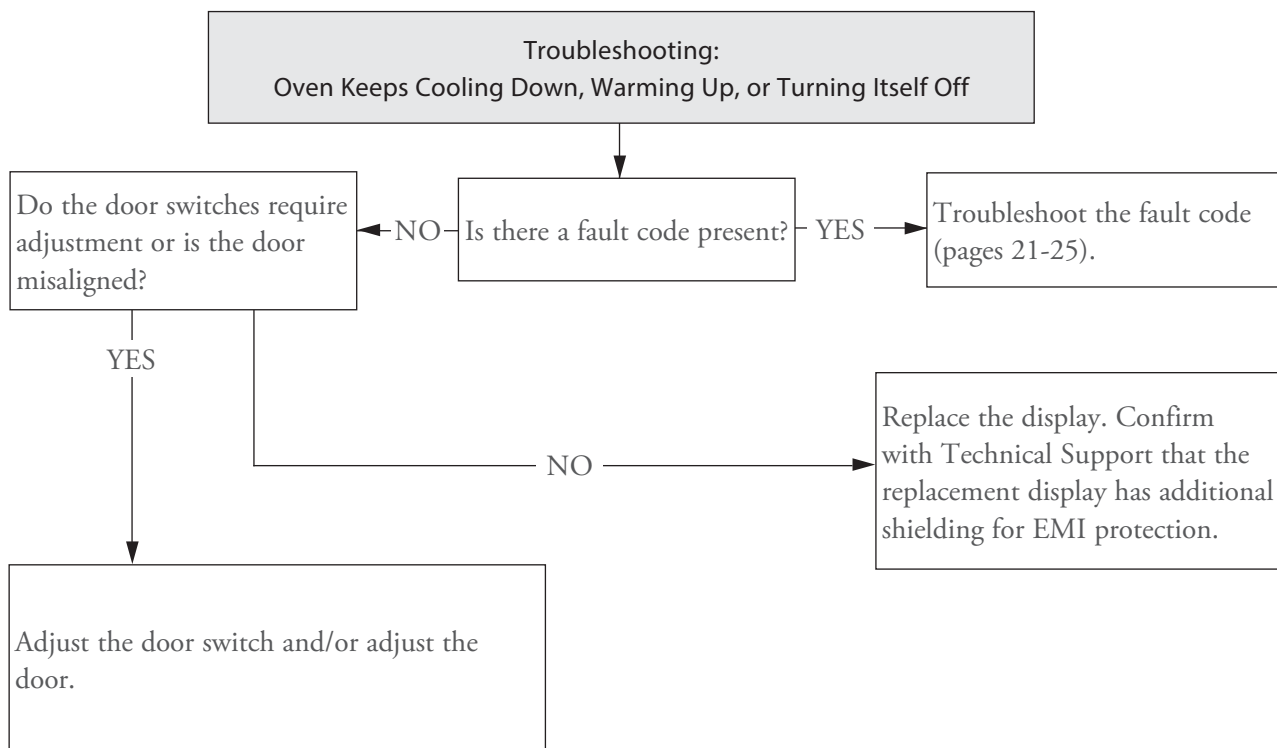

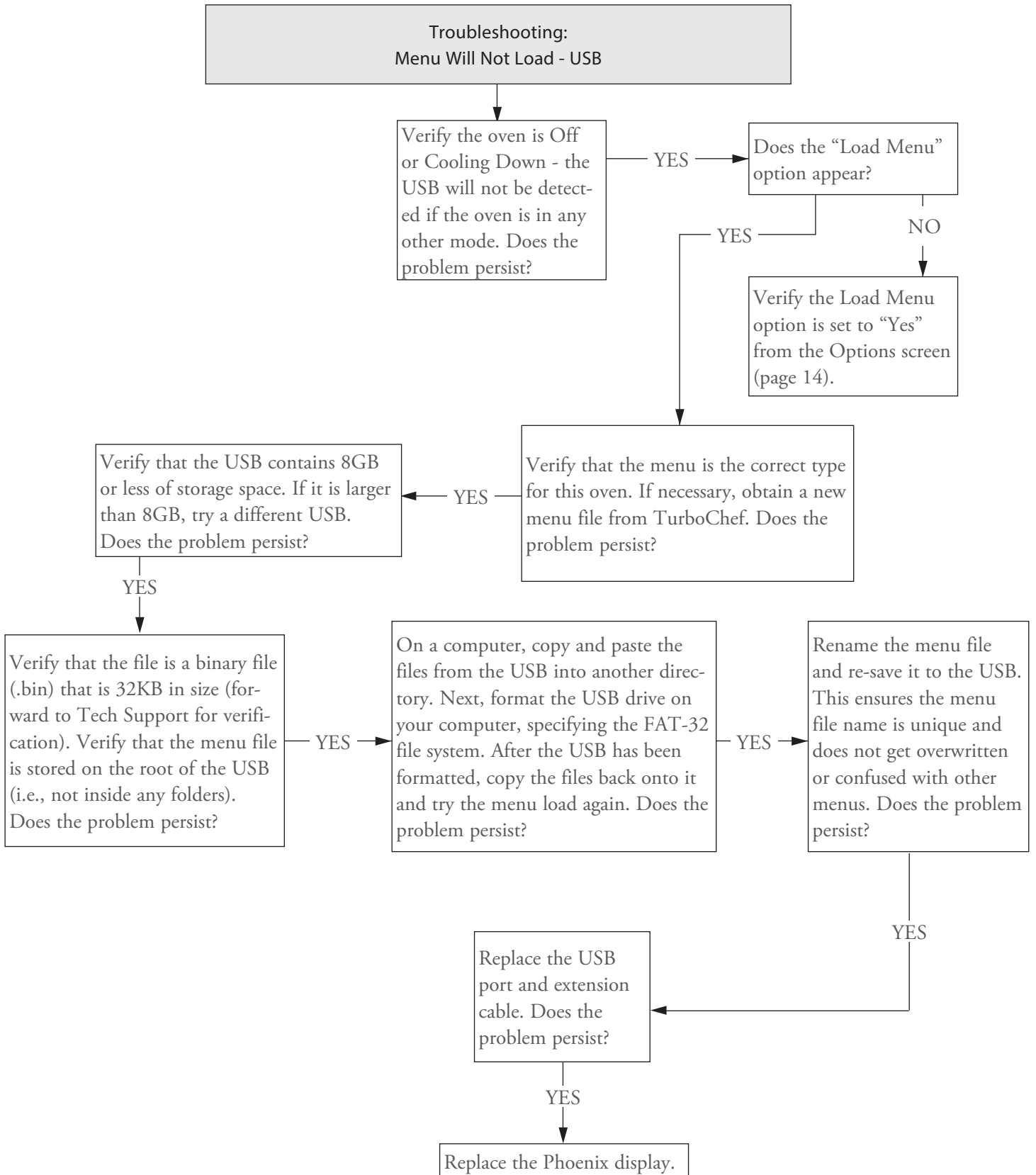

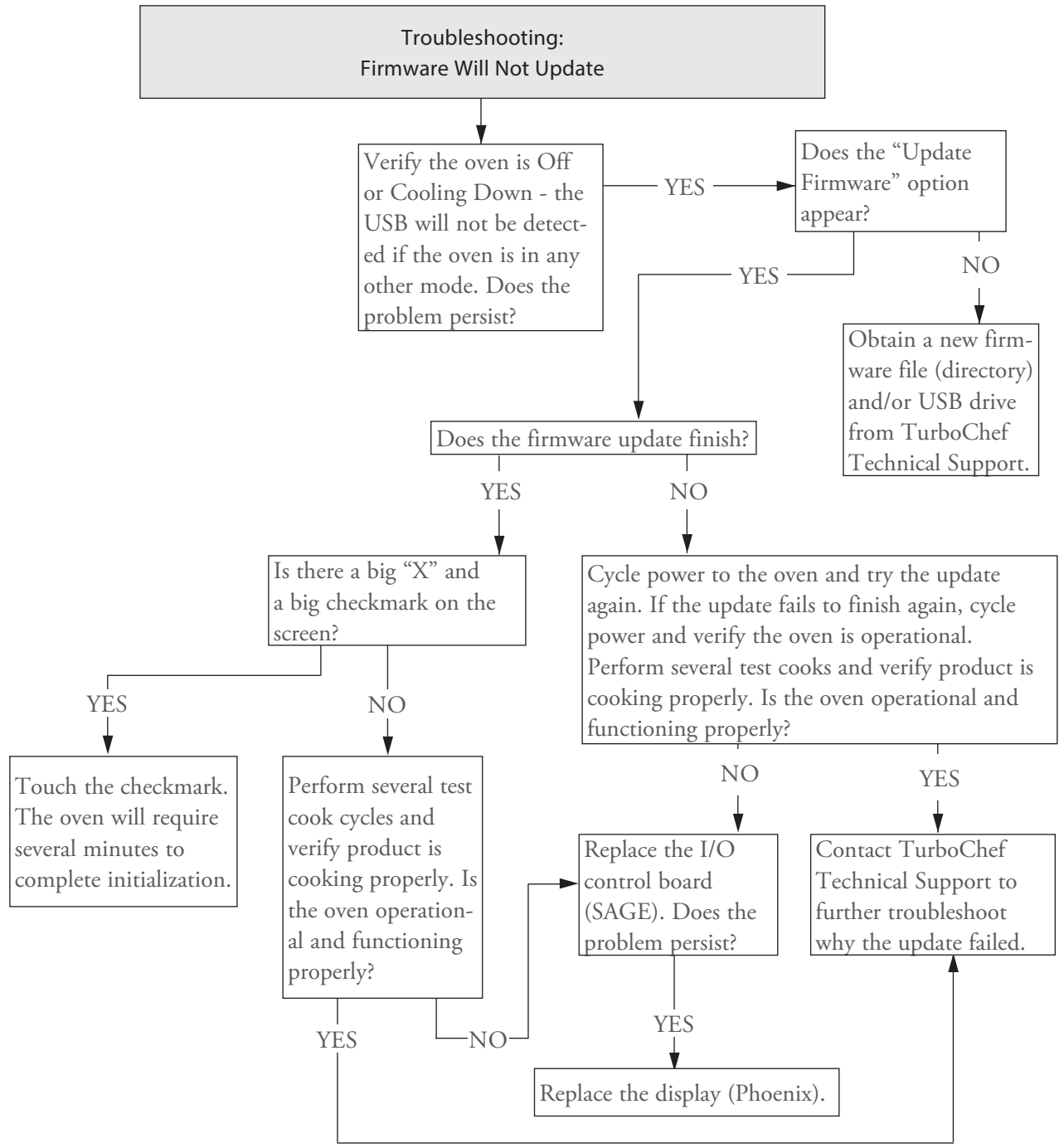

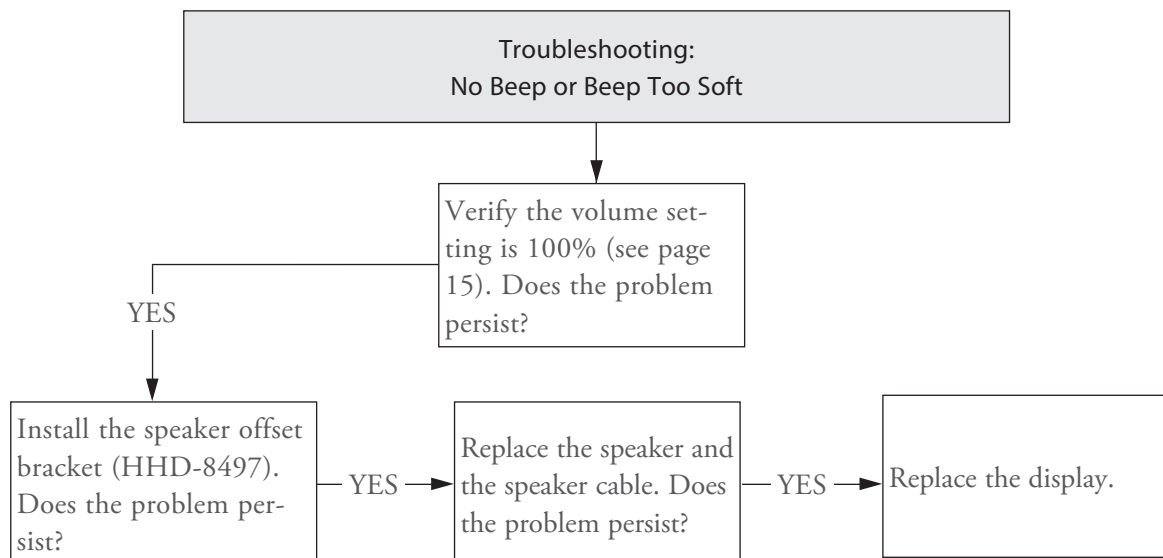
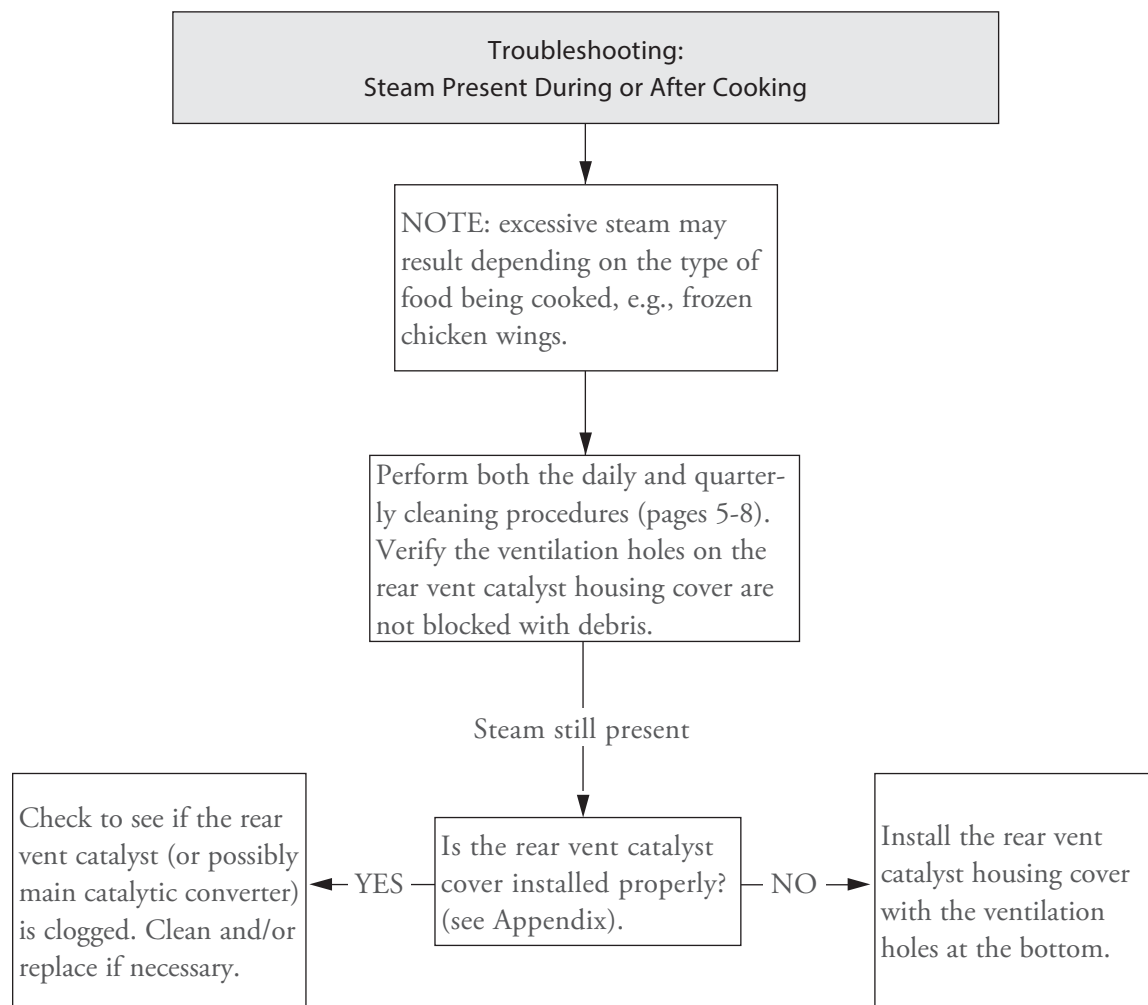

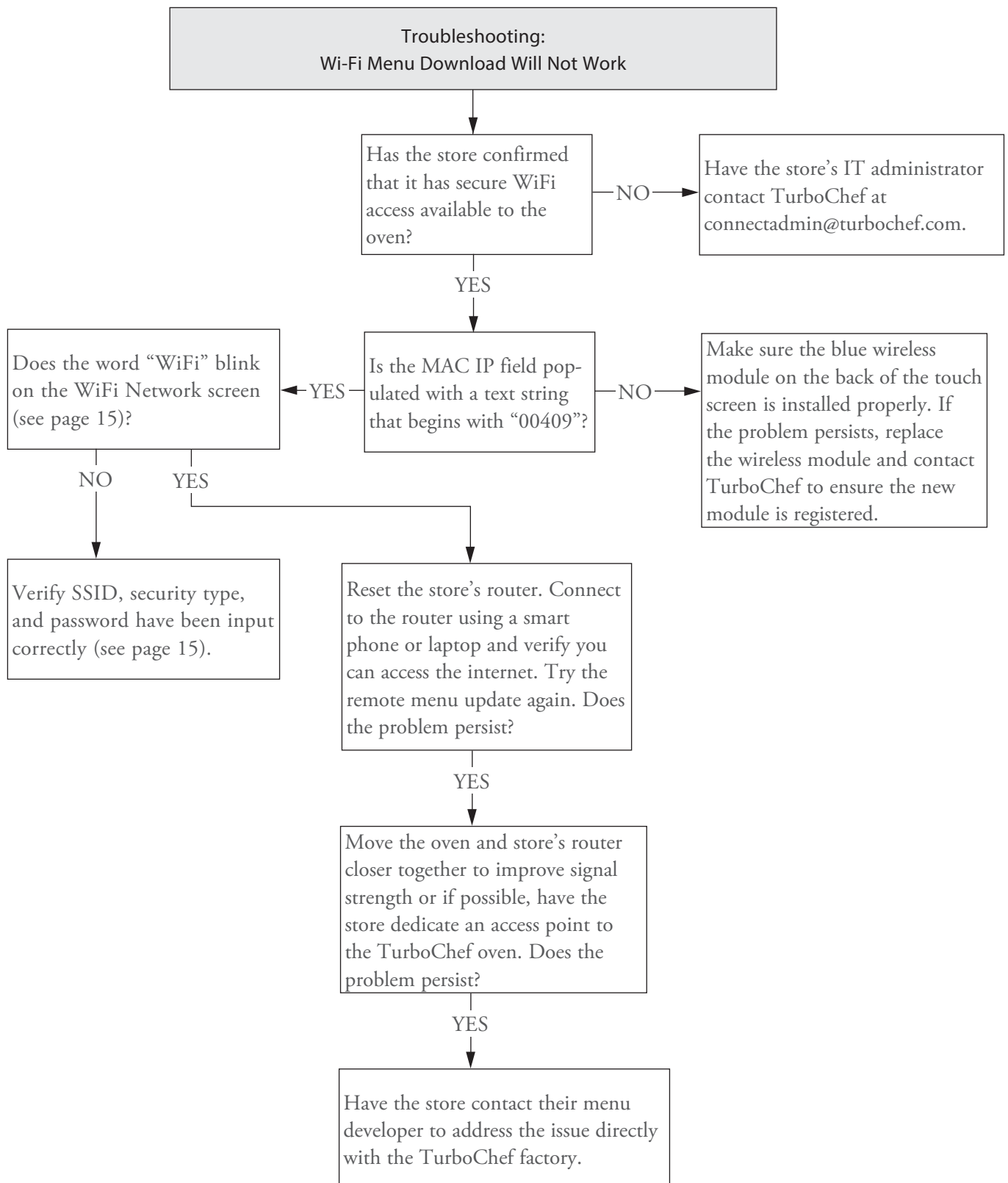

Oven Systems and Components

Controls System

The control system signals, senses, commands, and actuates all electrical components within the oven. See page 41 for a schematic.

The control system consists of the following components:

- Control board (SAGE)
- Cooling fans
- Display and UI Control Board (Phoenix)
- EMI filter
- Fuses
- Micro SD
- Power cord
- 12V Power supply
- 24V Power supply
- Relay, K1, K2, K3, & K4 – Rack Motors and Light Assemblies
- Relay, Solid State, K5/K6 & K7/K8 – Heaters
- Relay, K9 - Heaters
- RTD
- Thermostat, Cooling Fan
- Thermostat, High-Limit
- USB port
- Voltage sensor
- Wire harness
- WiFi module

Control Board (SAGE)

The control board (SAGE) signals each oven component based on commands from the touch display. 24 VDC can be measured at pin 2 of the J7 connector to confirm control voltage is being applied (see page 41).

Cooling Fans

The cooling fans (located in the rear of the oven) are actuated by the cooling fan thermostat when the temperature of the electrical compartment reaches 120°F (49°C).

Display and UI Control Board (Phoenix)

The display is the primary user interface. It is a 7-inch capacitive touch screen with a tempered protective glass cover. Included with the display is the UI control board (Phoenix). The Phoenix control board handles all UI-related tasks, including graphics, menu and data storage, and programming/data transfer, such as USB and Wi-Fi.

EMI Filters

The EMI filters help suppress the amount of RF interference emitted by the oven.

Fuses

The fuses are 12-amp, ATMR, type D. The fuses are designed to blow in case of an over-current situation relative to these components:

- BMSC motor controller
- Electrical compartment cooling fans
- Power supply
- Rack motor

For USDL configurations, there are three additional 30A fuses (ATMR) protecting the entire oven circuit.

Micro SD

The Micro SD Card is a 4GB card located on the back of the touch screen. It is used for additional on-board storage for the control board.

Power Cord

The power cord is equipped with a grounding wire and plug. See page 2 for different plug configurations, or page 41 for a schematic. To avoid potential hazards, only the manufacturer, an authorized service agent, or a similarly-qualified person should replace a damaged power cord.

12V Power Supply

The power supply outputs 12 VDC and powers the cook chamber lights.

24V Power Supply

The power supply outputs 24 VDC to the control board.

Relays, K1, K2, K3, & K4

The K1, K2, K3, & K4 relays are 240 VAC, 24 VDC coil, 20 amp, sealed single-pole relays.

The K1 and K2 relays control the top (K1) and bottom (K2) rack motors. The K3 and K4 relays control the top (K3) and bottom (K4) light assemblies.

Relays, Solid State, K5/K6 & K7/K8

The solid state relay is a 240 VAC, dual 40-amp relay. The K5/K6 controls the top cavity heaters and the K7/K8 relay controls the bottom cavity heaters.

Relay, K9

The K9 relay is a 30A double pole, double throw relays with a 24 VDC coil. The K9 relay is used to supply the second leg of power to the heaters when the oven is on.

RTD

One RTD measures the temperature of the top cavity, and another RTD measures the temperature of the bottom cavity. If the display reads “999°F/C”, at least one RTD is open, resulting in an F7 fault. See page 51 for troubleshooting.

Testing Procedure:

1. Disconnect the RTD from the control harness (see page 41 for schematic).
2. Place the RTD in ice water for two minutes.
3. Take a resistance reading of the RTD.
4. If RTD resistance is not 100 Ω (+/- 2 Ω), the RTD is defective and must be replaced.

Thermostat, Cooling Fan

The cooling fan thermostat actuates the rear cooling fans when the electrical compartment temperature reaches 120°F (49°C).

Thermostat, High-Limit

The high limit thermostat is a three-pole, manual-reset thermostat with a trip point of 572°F (300°C). The thermostat interrupts power to the main convection heater in the event of an abnormal condition. Reset the high-limit thermostat by pressing the reset button located on the back of the oven. There are two high limit thermostats, one for each cavity.

USB Port

The USB port allows the oven operator to load menus to and from a USB thumb drive. For instructions, see page 18. Firmware updates can also be performed via USB; contact the factory for assistance.

Voltage Sensor

For North America oven models, the oven will detect 208 or 240 incoming voltage.

Initial voltage selection is determined before the oven is used by the customer. However, if incoming voltage for the store is different than the preset voltage, the operator must select either 208 or 240 after pressing the On/Off key to turn on the oven. The correct voltage will be enlarged on the screen, identifying which option to select.

Wire Harness

The wire harness distributes power to the oven's electrical components. (See schematic, page 41).

WiFi Module

The WiFi module is responsible for transferring data wirelessly between the oven controller and TurboChef Connect. The oven logs events such as cook cycles and faults to TurboChef Connect, and menu updates can be pushed via TurboChef Connect to one or many ovens simultaneously. The recommended range from the oven to the router is 60 feet or less.

Convection System

The convection system is designed to rapidly heat, clean, and recirculate air into the cook cavity. See page 41 for a schematic.

The convection system consists of the following components:

- Blower motors
- Blower motor speed controllers
- Heaters
- Jetplates
- Jetplate support rails
- Oven rack
- Rack oscillation motor
- Swing arm assembly

Blower Motors

The convection motor is a brushless AC switch reluctance type. Its top speed is 7100 RPM at 1 HP. The motor is controlled by a proprietary controller, spins counterclockwise, and can be tested on the service screen (page 16).

Blower Motor Speed Controllers

The blower motor speed controller (BMSC) is proprietary and will only operate the convection motor described above. It is controlled via 0-10 VDC speed command from the control board. The BMSC can be tested on the service screen by testing the blower motors (see page 16).

Heaters

There are two convection sheathed-style heaters for each cavity. Each heater is rated at 3000 watts at 208 VAC with a resistance of 14.4 ohms. The heaters are controlled by the K5/K6 (top cavity) and K7/K8 (bottom cavity) solid state relays. The heaters can be tested on the service screen (see page 16).

Jetplates

The jetplates channel air from the blower motor into the cook cavity. Different hole patterns are available for custom cooking results; contact TurboChef for more details.

Jetplate Support Rails

Each jetplate is supported by two rails. These rails must be removed prior to replacing or removing the jetplate for cleaning (see pages 5-8 for detailed cleaning instructions).

NOTE: Some models may not include support rails.

Oven Rack

The oven rack sits on two pins and oscillates to help ensure even cooking.

Rack Oscillation Motor

The rack oscillation motor actuates the swing arm assembly, which causes the rack to oscillate. The motor can be tested on the service screen (see page 16).

Swing Arm Assembly

The swing arm assembly consists of two arms connected by a link bar beneath the oven cavity. It is actuated by the rack oscillation motor.

Oven Door

The oven door consists of the following components:

- Door Gasket
- Door Interlock Switch

Door Gasket

The door gasket ensures a proper seal when the door is closed.

 **CAUTION:** Do not scrub the gasket or attempt to scrape beneath it. Doing so will damage the gasket, resulting in a non-warranty service call.

Door Interlock Switches

Each interlock switch engages and disengages when its respective door is opened/closed, alerting the control system of the oven door state.

To adjust the door interlock switch, follow the steps below.

1. Ensure the oven is at operating temperature.
2. Confirm the door closes properly.
3. Adjust the door interlock switch paddle arm to close completely, but not touching the switch itself.
4. Tighten the three adjustment screws.

Filtering System

The filtering system consists of the following components:

- Grease filter
- Catalytic converter

Grease Filter

The grease filter is located on the rear cavity wall and helps remove grease and food particles from the recirculating airflow. Checking the filter daily is recommended to ensure optimal oven operation. See pages 5-8 for cleaning instructions.

Catalytic Converter

The catalytic converter, a VOC type catalyst, is located behind the rear cook cavity wall and is responsible for cleaning the recirculating airflow. The catalyst functions by substantially lowering the combustion temperature of grease entrained in the air path to approximately the same temperature of the airflow, thus the grease burns and breaks down into CO₂ and H₂O as it passes through the catalytic converter. The catalyst will operate most efficiently at temperatures above 475°F (246°C).

The catalytic converter is self-cleaning. It is not a component that requires scheduled maintenance. Additionally, the catalyst material is very sensitive to certain chemical compounds. Irreversible damage can occur if the catalyst is exposed to cleaning chemicals containing phosphates, NaOH, silicates, Na and Potassium Salts; therefore, use only Turbo-Chef Oven Cleaner when cleaning the oven.

*This page intentionally
left blank.*

Schematics

ELEMENT LAYOUT

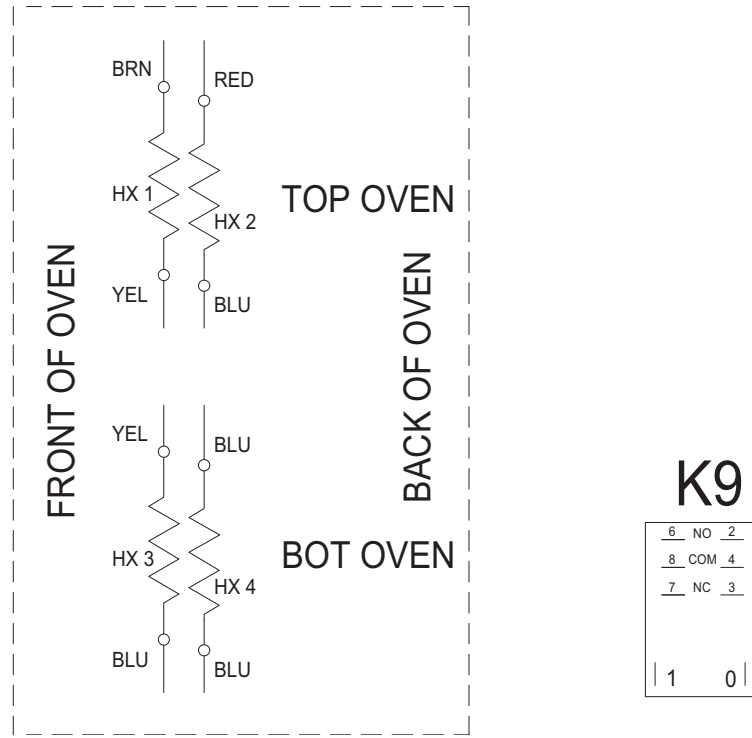

RED - VDC OUTPUT
 WHITE - CONTROL OUTPUT
 BLACK - GROUND
 ORANGE - STATUS OUTPUT

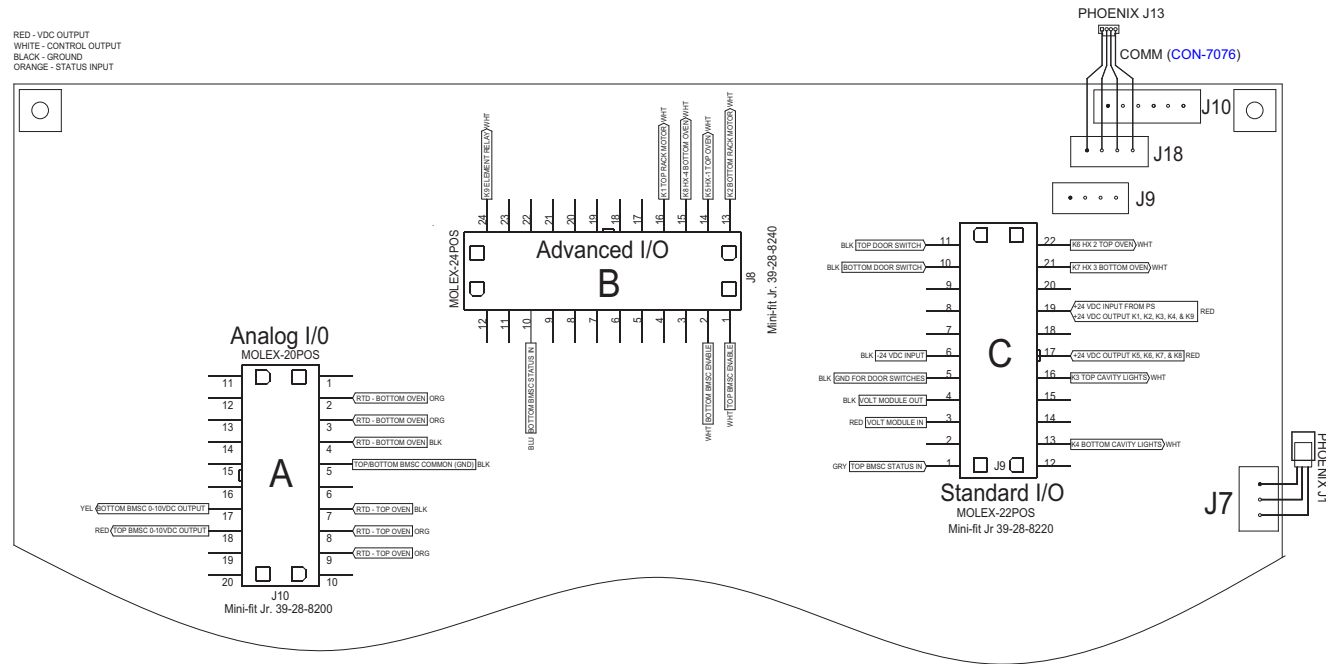
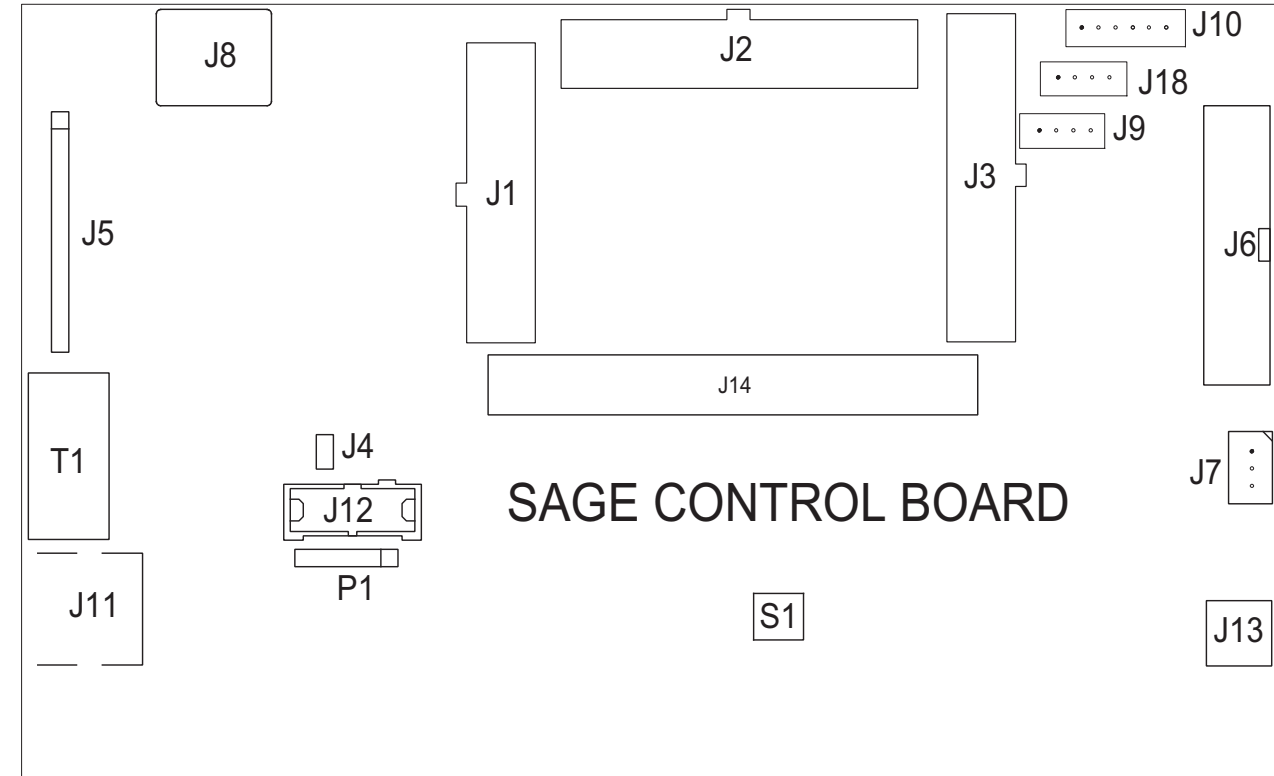

- J1 - "A" CONNECTOR
- J2 - "B" CONNECTOR
- J3 - "C" CONNECTOR
- J4 - NOT USED
- J5 - NOT USED
- J6 - NOT USED
- J7 - 24 VDC POWER (TO TOUCH DISPLAY J1)
- J8 - RJ11 CONNECTOR
- J9 - SAME AS J18
- J10 - NOT USED
- J11 - NOT USED
- J12 - NOT USED
- J13 - NOT USED
- J14 - 40 PIN CONNECTOR (NOT USED)
- J18 - SAME AS J9 (TO TOUCH DISPLAY J13)
- P1 - NOT USED
- S1 - RESET SWITCH
- T1 - CURRENT SENSOR

Figure 23: Oven Schematic - Control Boards and Heaters

Appendix - Replacing Oven Components

Replacing Oven Components

This appendix provides illustrations for removing serviceable items, as well as the item numbers and descriptions for those items. It also includes the item numbers and descriptions for the fasteners used to secure each component to the oven chassis.

The appendix is divided into the following sections:

- Oven Face and Removable Cavity Parts (pages A-2 through A-3)
- Oven Door (pages A-4 through A-5)
- Oven Components, Side Panel Removed (pages A-6 through A-7)
- Oven Components, Controls (pages A-8 through A-9)
- Oven Components, Back Panel Removed (A-10 through A-11)

If you have any questions that are not addressed in this manual or appendix, please contact TurboChef Customer Service at 800.90TURBO or +1 214.379.6000.

Oven Face and Removable Cavity Parts

⚠ WARNING: Before removing any oven part, be sure the oven has completed “cooling down” (see “Step 10” on page 11) and is removed from the power source.

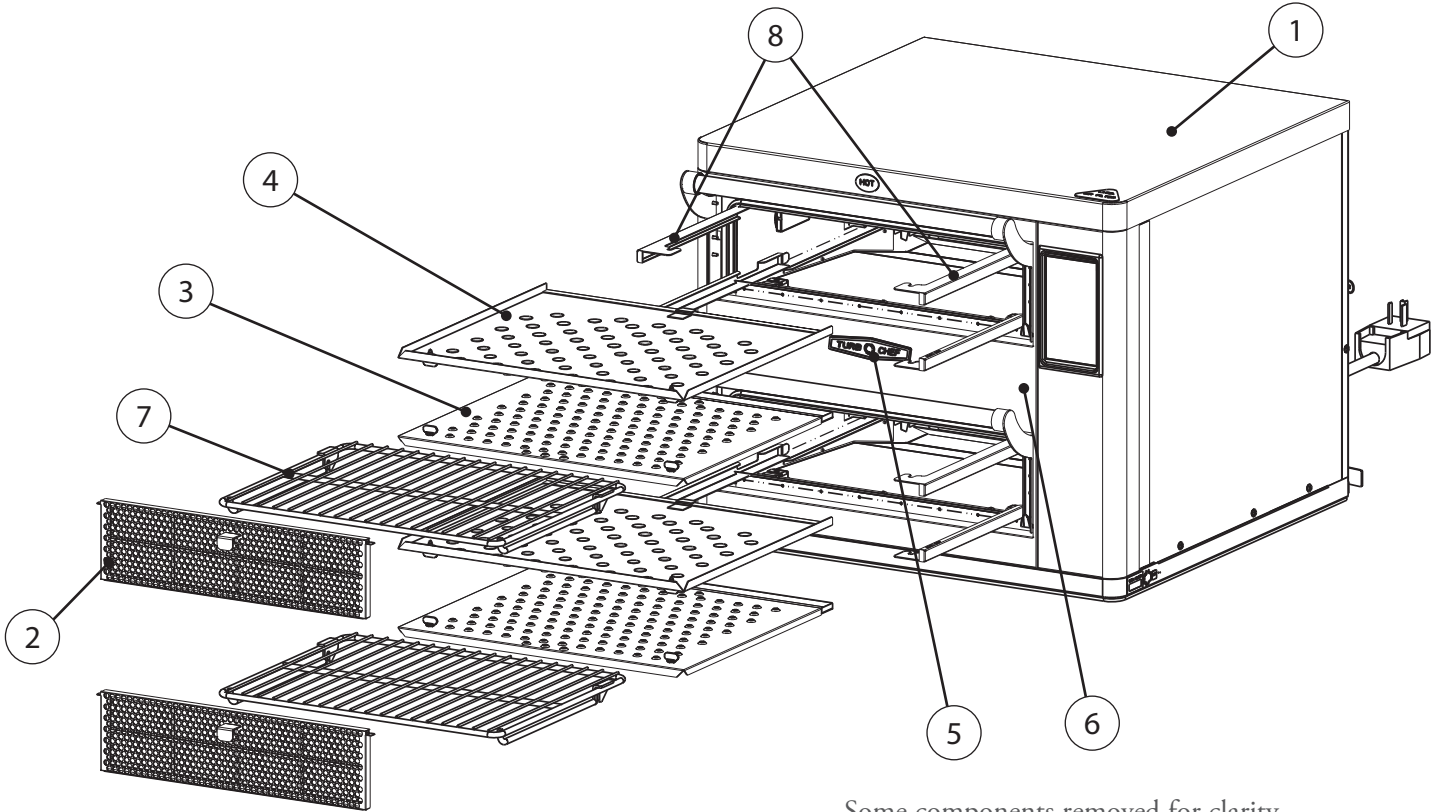

Some components removed for clarity.

Figure Reference #	Item Description	Item Part Number	Fastener Description	Fastener Part Number(s)
1	Cover, Top	HHD-8254	Screw # 8 X 3/8 Phil. Mod. Truss B 410, SS Screw, #8 X 1/2 Phil., Truss, Type 17, Serr, SS	101682 (qty 3, back) 101688 (qty 3, front)
2	Filter, Grease	HHD-8423 (qty 1 per cavity)	N/A	N/A
3	Jetplate, Bottom (Kit)	HHD-3001 (qty 1 per cavity)	Fast Lead Mounting Clip Screw, Wing Head, Fast Lead, SS Fast Lead Screw Retainer	Included with Kit
4	Jetplate, Top (Kit)	HHD-3002 (qty 1 per cavity)	Fast Lead Mounting Clip Screw, Wing Head, Fast Lead, SS Fast Lead Screw Retainer	Included with Kit
5	Logo, TurboChef	HHC-6336	Nut, Push 1/8 Dia, Tinnerman	101293 (qty 2)
6	Panel, Front	HHD-8384	Screw 8-32 X 3/8 PFLH, 100 Deg, SS	102809 (qty 4)
7	Rack, Cooking	HHD-8104-3 HHD-8522 (Stone) HHD-8490 (Stone, Front Guard Removed) (qty 1 per cavity)	N/A	N/A
8	Rails, Jetplate Support (Kit)	HHD-3004 (qty 2 per cavity)	N/A	N/A
Not Shown	Stone, Baking	HHD-8489 (qty 1 per cavity)	N/A	N/A

Oven Face and Removable Cavity Parts, Continued

⚠ WARNING: Before removing any oven part, be sure the oven has completed “cooling down” (see “Step 10” on page 11) and is removed from the power source.

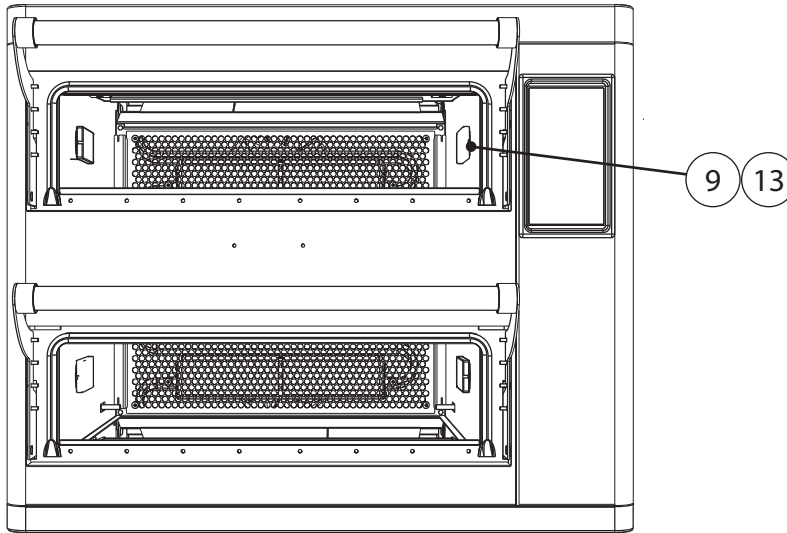

Some components removed for clarity.

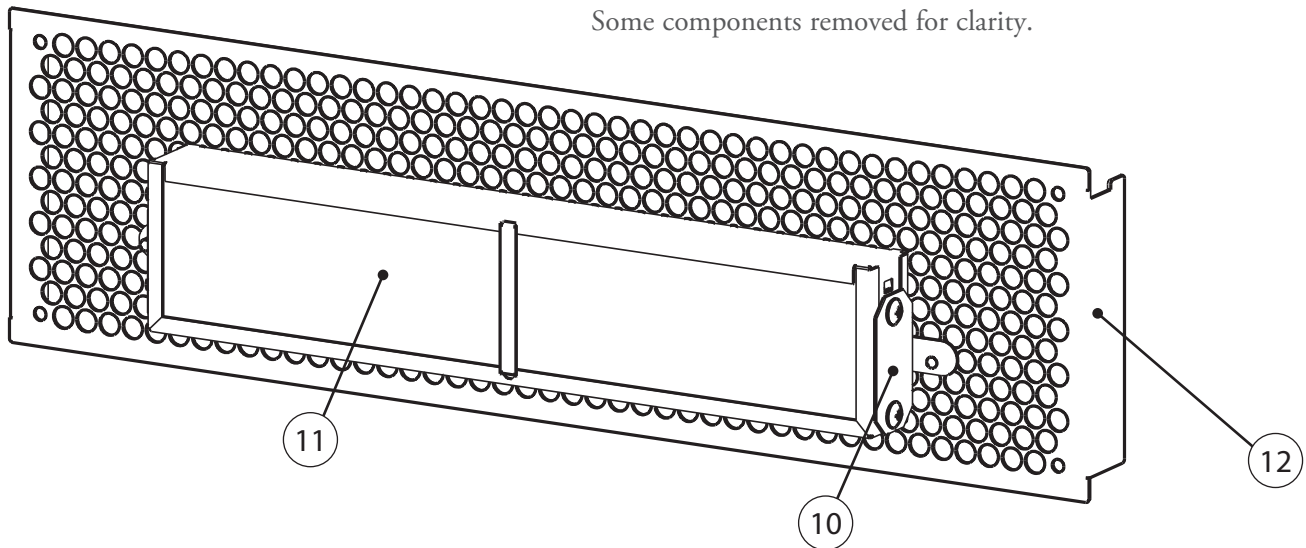

Figure Reference #	Item Description	Item Part Number	Fastener Description	Fastener Part Number(s)
9	Bulb, Replacement, Xenon	105050	N/A	N/A
10	Bracket, Catalytic Converter	ENC-1148 (qty 2 per cavity)	Screw, #8 X 1/2 Phil., Truss, Type 17, Serr, SS	101688 (qty 2)
11	Catalytic Converter	ENC-1147 (qty 1 per cavity)	Screw, #8 X 1/2 Phil., Truss, Type 17, Serr, SS	101688 (qty 4)
12	Diverter, Air, Perforated	HHD-8289 (qty 1 per cavity)	Screw, #8 X 1/2 Phil., Truss, Type 17, Serr, SS	101688 (qty 4)
13	Light Assembly with Bulb, 10W, 12V, G9, 450C	HHD-8503 (qty 2 per cavity)	Screw, Drill Pt, 6-32 x 3/8 PPH, Zinc	101684 (qty 1)

Oven Door

⚠ WARNING: Before removing any oven part, be sure the oven has completed “cooling down” (see “Step 10” on page 11) and is removed from the power source.

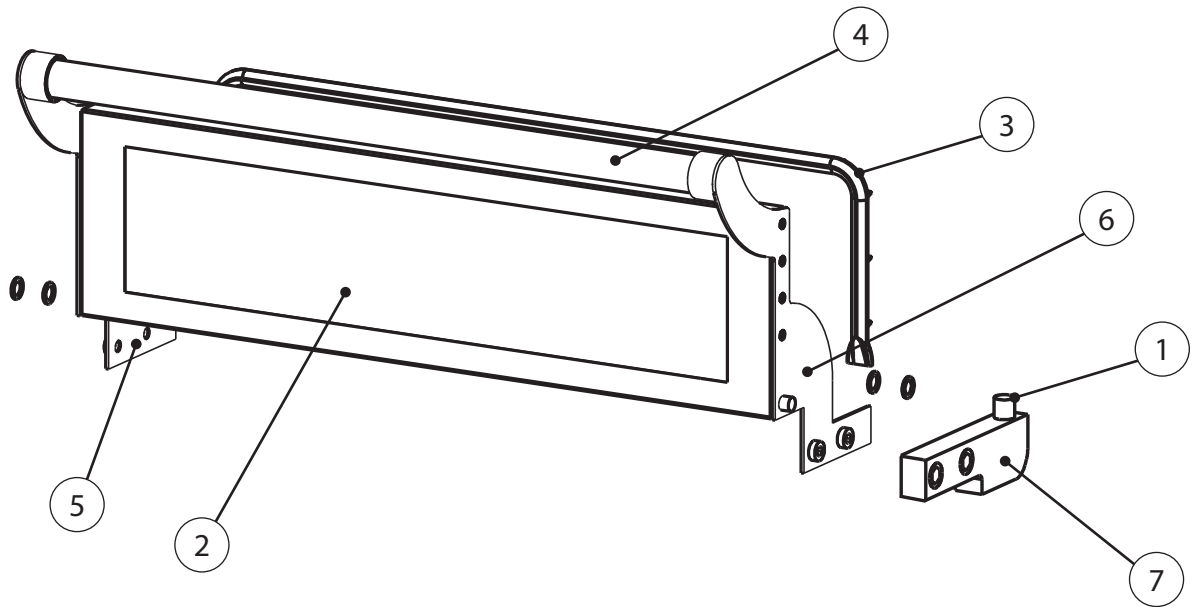

Figure Reference #	Item Description	Item Part Number	Fastener Description	Fastener Part Number(s)
1	Bumper, Round	105047 (qty 2 per door)	N/A	N/A
2	Door Kit (Glass/Frame)	HHD-8377 (qty 1 per door)	Screw, 6-32 X .38 PFH 100 Deg, SS	101430 (qty 8 per door)
3	Gasket, Door	HHD-8236 (qty 1 per door)	N/A	N/A
4	Handle, Door	HHD-8383 (qty 1 per door)	RTV Sealant, Hi-temp, Gray, 600F, #82195	105024
5	Hinge, Left	HHD-8378 (qty 1 per door)	Spacer, .385" ID X .574" OD X .040" Thk, SS	102725 (qty 4 per door)
6	Hinge, Right	HHD-8379 (qty 1 per door)	Spacer, .385" ID X .574" OD X .040" Thk, SS	102725 (qty 4 per door)
7	Weight, Door	HHD-8380 (qty 2 per door)	Screw, 1/4-20 X 1/2 Lg, HWH, Serr, SS	101394 (qty 2 per hinge)

Oven Components, Side Panels Removed

⚠ WARNING: Before removing any oven part, be sure the oven has completed “cooling down” (see “Step 10” on page 11) and is removed from the power source.

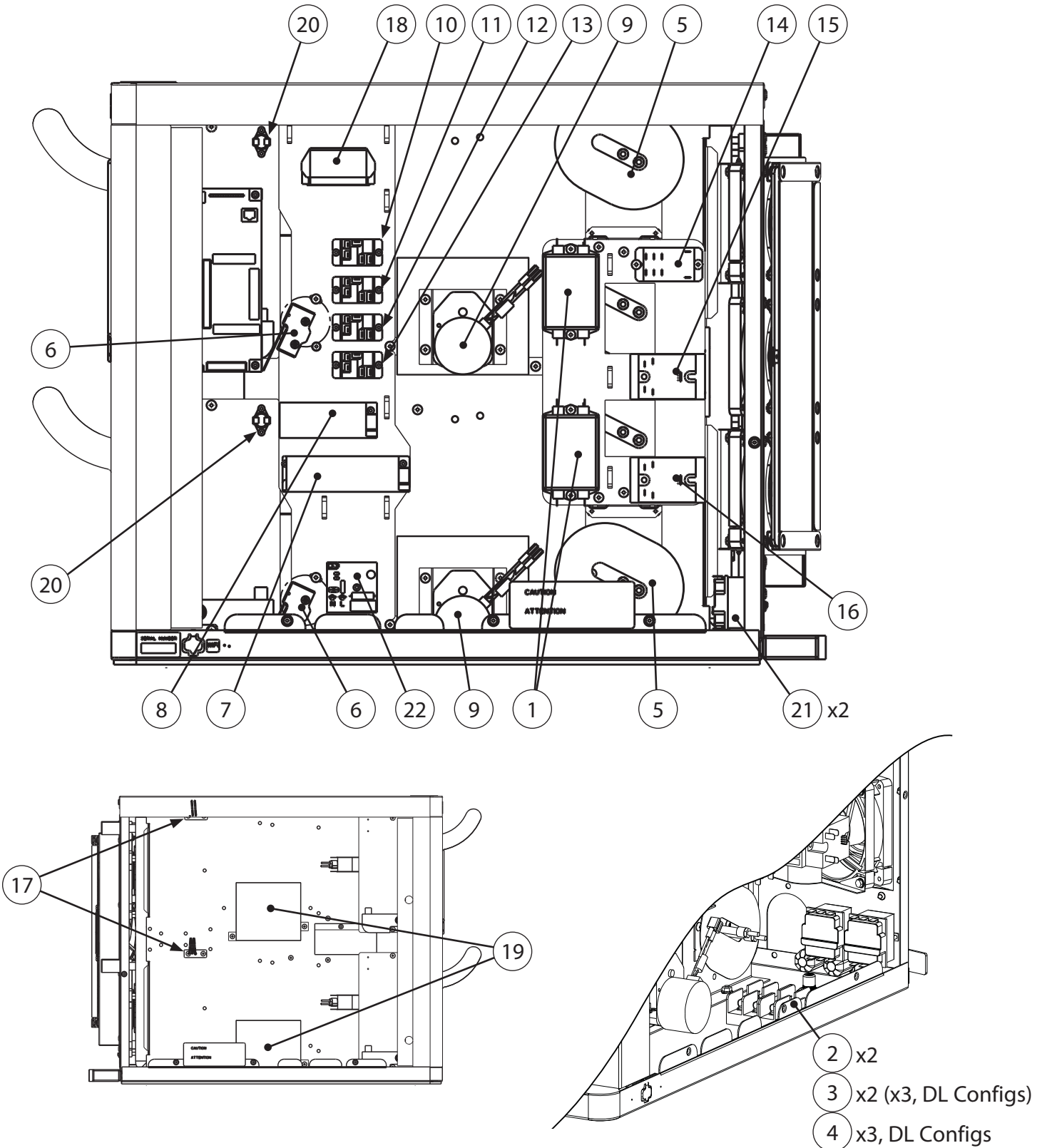

Figure Reference #	Item Description	Item Part Number	Fastener Description	Fastener Part Number(s)
1	EMI Filter	100539 (qty 1 per cavity)	Screw, #8 X 1/2 Phil., Truss, Type 17, Serr, SS	101688 (qty 2 each)
2	Fuse Block	DL Config: 103566 (qty 2) All Others: 103548 (qty 2)	Nut #6-32 Keps External Tooth SS	102961
3	Fuse, 12 amp, Class CC, ATMR	DL Config: 100592 (qty 3) All others: 100592 (qty 2)	N/A	N/A
4	Fuse, 30 amp, Class CC, ATMR	DL Config: 105196 (qty 3) All others: None	N/A	N/A
5	Heater, Kit	HHD-3003 (qty 1 per cavity)	Screw, #8 X 1/2 Phil., Truss, Type 17, Serr, SS	101688 (qty 6 each)
6	Interlock Switch	105022 (qty 1 per cavity)	Screw, RD SL, 8-32 x 1, M/S 18-8	101662 (qty 2 each)
7	Power Supply, 12 VDC	US: 105034 Intl: 105191	Screw, #6-32 x 1/2, PPH, Drill Point, Zinc	101687 (qty 2)
8	Power Supply, 24 VDC	US: 101213 Intl: 105190	Screw, #6-32 x 1/2, PPH, Drill Point, Zinc	101687 (qty 2)
9	Rack Motor, Kit with Mount	HHD-3012 (qty 1 per cavity)	Screw, #8 X 1/2 Phil., Truss, Type 17, Serr, SS	101688 (qty 2 each)
10	Relay, K1 (Upper Rack Motor)	101274	Screw, #6-32 x 1/2, PPH, Drill Point, Zinc	101687 (qty 2)
11	Relay, K2 (Bottom Rack Motor)	101274	Screw, #6-32 x 1/2, PPH, Drill Point, Zinc	101687 (qty 2)
12	Relay, K3 (Upper Cavity Lights)	101274	Screw, #6-32 x 1/2, PPH, Drill Point, Zinc	101687 (qty 2)
13	Relay, K4 (Lower Cavity Lights)	101274	Screw, #6-32 x 1/2, PPH, Drill Point, Zinc	101687 (qty 2)
14	Relay, K9 (Heaters)	101279	Screw, #8 X 1/2 Phil., Truss, Type 17, Serr, SS	101688 (qty 2)
15	Relay, Solid State, K5/K6 (Upper Heaters)	101286	Screw, #8 X 1/2 Phil., Truss, Type 17, Serr, SS	101688 (qty 2)
16	Relay, Solid State, K7/K8 (Lower Heaters)	101286	Screw, #8 X 1/2 Phil., Truss, Type 17, Serr, SS	101688 (qty 2)
17	RTD Temperature Sensor, 3.0"	HHC-6517-2 (qty 1 per cavity)	Screw, #8 X 1/2 Phil., Truss, Type 17, Serr, SS	101688 (qty 2 each)
18	Speaker	CON-7038	Bracket, Speaker, Standoff Screw, #6-32 x 1/2, PPH, Drill Point, Zinc	HHD-8497 101687 (qty 4)
19	Swing Arm Assembly, Kit with Motor and Mount	HHD-3010 (qty 1 per cavity)	Bushing, 5/16, Flange Mount Screw, #8 X 1/2 Phil., Truss, Type 17, Serr, SS	Included with Kit
20	Thermostat, Cooling Fan, EC, 120F	102086 (qty 2)	Screw, #6-32 x 1/2, PPH, Drill Point, Zinc	101687 (qty 2 each)
21	Thermostat, High-Limit, 300C	102075 (qty 1 per cavity)	Screw, M4 x 0.7 x 8, PPHD, Int Tooth, SS	101672 (qty 2 each)
22	Voltage Sensor	CON-3027	Nut, #6-32, Hex, SS Screw, #6-32 x 1/4 LG, PPH, SS Standoff, #6-32 x 1/2, M/F, Hex, Zinc	Included in kit
Not Shown	Harness, Cooling Fans 1	HHD-8434	N/A	N/A
Not Shown	Harness, Cooling Fans 2	HHD-8436	N/A	N/A
Not Shown	Harness, Heater Wire	HHD-8433	N/A	N/A
Not Shown	Harness, Line Voltage	HHD-8431	N/A	N/A
Not Shown	Harness, Low Voltage	HHD-8432	N/A	N/A
Not Shown	Wire, Heater Fuse Terminal (DL config only)	HHD-8437 (qty 3)	N/A	N/A

Oven Components, Controls

⚠ WARNING: Before removing any oven part, be sure the oven has completed “cooling down” (see “Step 10” on page 11) and is removed from the power source.

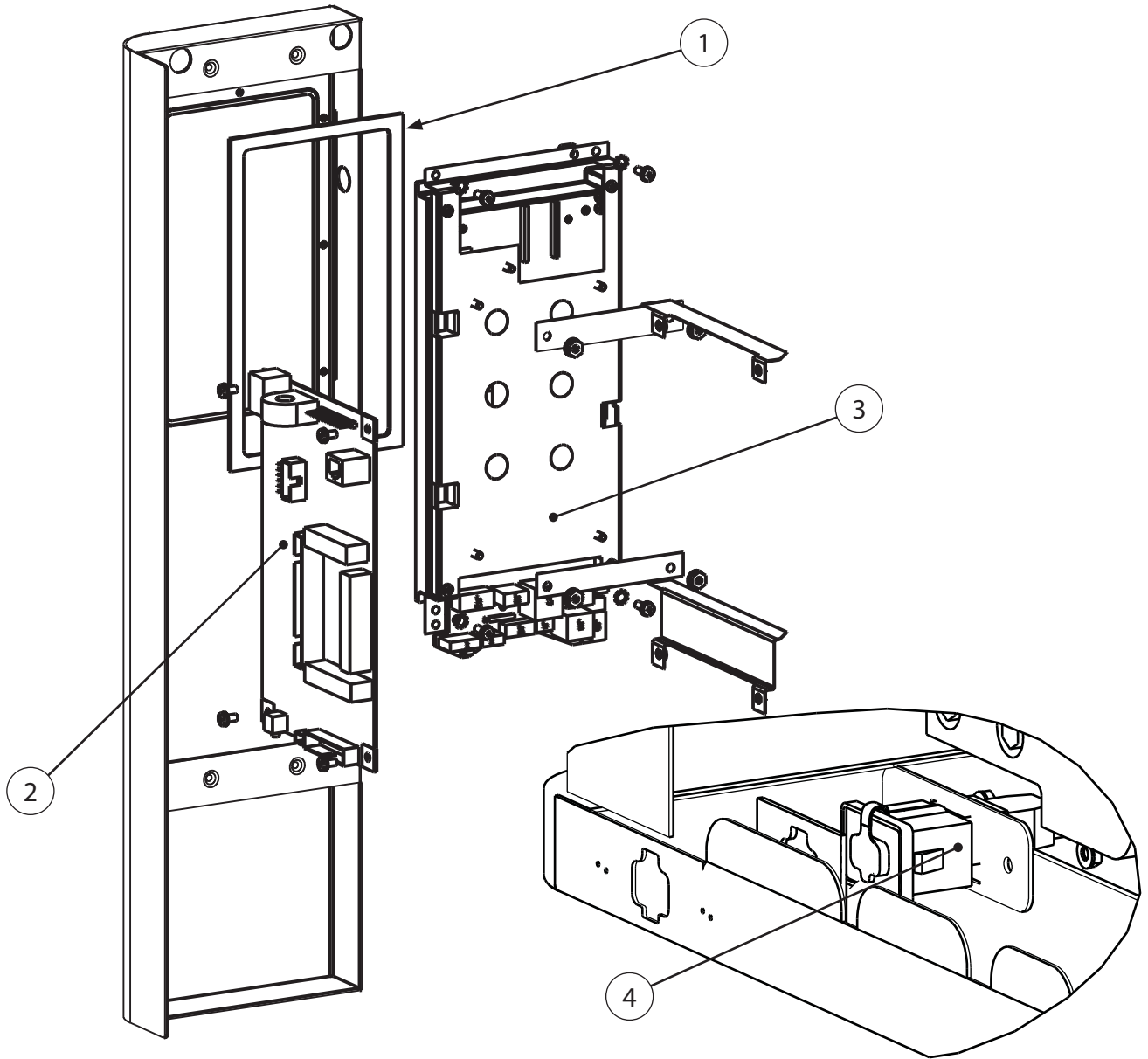

Figure Reference #	Item Description	Item Part Number	Fastener Description	Fastener Part Number(s)
1	Gasket, Display	HHD-8447	N/A	N/A
2	SAGE Control Board, Kit	CON-3019-2	Screw, #6-32 x 1/4, SIM, Int Tooth, PPHD Nut #6-32 Keps External Tooth SS Bracket, Control Board Mounting, Top Bracket, Control Board Mounting, Bottom	102910 (qty 4) 102961 (qty 4) HHD-8493 HHD-8494
3	Touch Screen, Kit	CON-3028-7	Washer, Lock, #6 EXT TH, CRES Screw, #6-32 x 38 Lg, PPHD, SEMS, CRES	102270 (qty 4) 102911 (qty 4)
4	USB Socket	100419	Bracket, USB Gasket, USB Nut, Keps Hex, #6-32, EXT Tooth, CRES	HHD-8467 HHD-8448 102961 (qty 2)
Not Shown	Cable, SAGE to Touch Display	CON-7076	N/A	N/A
Not Shown	Cable, Speaker	CON-7077	N/A	N/A
Not Shown	Cable, USB	100418	N/A	N/A
Not Shown	Cable, Display Power	i1-9475	N/A	N/A

Oven Components, Back Panel Removed

⚠ WARNING: Before removing any oven part, be sure the oven has completed “cooling down” (see “Step 10” on page 11) and is removed from the power source.

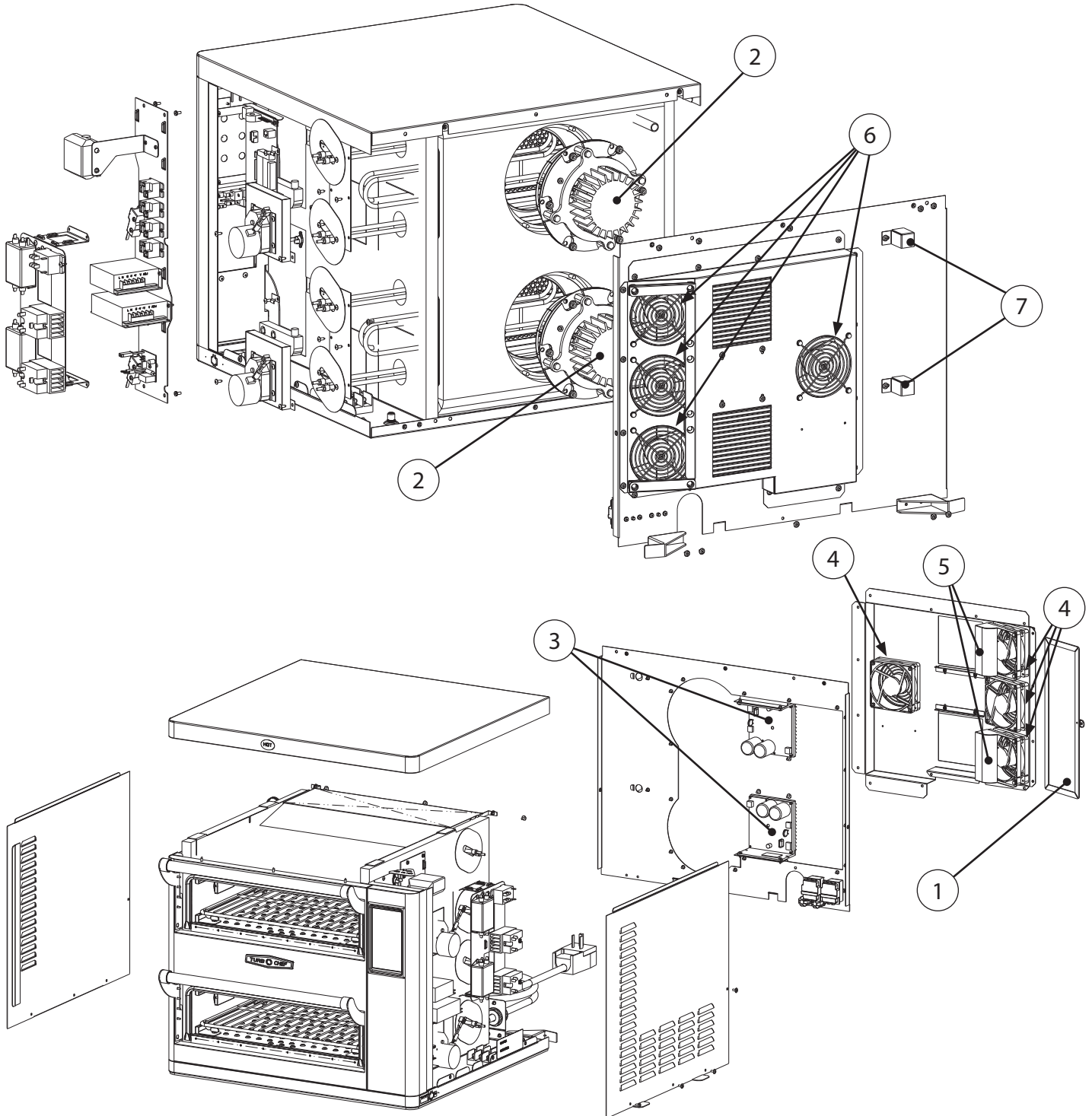

Figure Reference #	Item Description	Item Part Number	Fastener Description	Fastener Part Number(s)
1	Air Filter	HHD-8422	N/A	N/A
2	Blower Motor	HHB-8106 (qty 1 per cavity)	Nut, 1/4-20, Serrated Hex Flange, Zinc	100906 (qty 5 each)
3	Blower Motor Speed Controller	CON-7013 (qty 1 per cavity)	Screw, #8 X 1/2 Phil., Truss, Type 17, Serr, SS Screw, #8-18 x 3/8 PMTRH, CRES	101688 (qty 2 each) 101682 (qty 2 each)
4	Cooling Fan	US: 100516 (qty 4) Intl: 105181 (qty 4)	Screw, #10 -32 x 1/2, Hex WSHR HD, Type 23	101408 (qty 4 each)
5	Cooling Fan Duct	HHD-8475	Screw, #10 -32 x 1/2, Hex WSHR HD, Type 23	101408 (qty 2 each)
6	Finger Guard	US: 100087 (qty 4) Intl:	Screw, #10 -32 x 1/2, Hex WSHR HD, Type 23	101408 (qty 4 each)
7	Vent Catalyst Cover	HHD-8477 (qty 1 per cavity)	Screw, #8-18 x 3/8 PMTRH, CRES	101682 (qty 2 each)
Not Shown	Power Cord, 60 Hz, 208-240 VAC, 1 PH, US	i5-9127	None	None
Not Shown	Power Cord, 60 Hz, 208-240 VAC, 3 PH, US	i5-9128	None	None

For service or information:

WITHIN NORTH AMERICA CALL

Customer Support *at* 800.90TURBO

OUTSIDE NORTH AMERICA CALL

+1 214.379.6000 or Your Authorized Distributor



Part Number: HHD-1002 / Revision B / August 2017
Country Code: NA/EU

Global Operations

2801 Trade Center Drive
Carrollton, Texas 75007 USA
+1 214.379.6000 PHONE
+1 214.379.6073 FAX

Customer Support

800.90TURBO
+1 214.379.6000
turbochef.com