



Quality Refrigeration

OWNER'S MANUAL

**Instructions for the installation, operation
and maintenance of all Traulsen:**

G-Series Reach-In & Pass-Thru Refrigerators*

G-Series Reach-In & Pass-Thru Hot Food Holding Cabinets

G-Series Reach-In Freezers*

G-Series Hinged Glass Door Refrigerators*

*For equipment produced after 10/1/08 only.

This Traulsen unit is built to our highest quality standards. We build our refrigerators, freezers and heated cabinets this way as a matter of pride. This philosophy has made Traulsen the leader in commercial refrigeration since 1938. We thank you for your choice and confidence in Traulsen equipment and we know you will receive many years of utility from this equipment.

All Traulsen units are placed on a permanent record file with the service department. In the event of any future questions you may have, please refer to the model and serial number found on the name tag affixed to the unit. Should you need service, however, call us on our toll free number, 800-825-8220 between 7:30 a.m. and 4:30 p.m. CST, Monday thru Friday. It is our pleasure to help and assist you in every possible way.

INSTALLER

COMPLETE THE FOLLOWING INFORMATION PRIOR TO UNIT INSTALLATION

INITIAL START DATE: _____ SERIAL NO. _____

MODEL TYPE: _____

COMPANY/INDIVIDUAL NAME: _____

INSTALLER: _____

TABLE OF CONTENTS



I. THE SERIAL TAG	Page 1	VI. OTHER	
II. RECEIPT INSPECTION	Page 2	a-Service Information	Page 6
III. INSTALLATION		b-Spare Parts	Page 6
a-Location	Page 2	c-Warranty Registration	Page 6
b-Packaging	Page 2	VII. MICROPROCESSOR CONTROL	
c-Installing Legs or Casters	Page 2	a-Control Features	Page 6-7
d-Shelf Pins	Page 3	b-Control Panel	Page 7
e-Removing The Doors & Hardware	Page 3	c-Parts Assembly	Page 7
f-Cord & Plug	Page 3	d-Notes To The User	Page 8
g-Power Supply	Page 3	e-Enter The Customer Access Code	Page 8
h-Wiring Diagram	Page 3	f-Customer Service Parameters	Page 9
i-Clearance	Page 4	g-Adjusting Thermostat Set Point High	Page 9
j-Installing Optional Interior Kits	Page 4	h-Adjusting Thermostat Set Point Low	Page 10
k-ON/OFF Switch	Page 4	i-Changing The Temperature Scale	Page 10
IV. OPERATION		j-Setting The 24-Hour Clock	Page 11
a-Refrigerators	Page 4	k-Setting The Date	Page 12
b-Freezers	Page 4	l-Setting Daylight Savings Time	Page 12
c-Light Switch	Page 4	m-Starting A Manual Defrost	Page 13
d-Special Display Mode	Page 4	n-Setting Defrost Lockouts	Page 14
V. CARE & MAINTENANCE		o-Adjusting The Room Temperature Offset	Page 15
a-Cleaning The Condenser	Page 5	p-Viewing Coil Sensor Temperature	Page 15
b-Hinge Replacement	Page 5	q-Hot Food Units - Adjusting The Thermostat	Page 16
c-Replacing The Gaskets	Page 5	r-Hot Food Units - Turning The Unit OFF & ON	Page 16
d-Cleaning The Exterior	Page 6	s-Hot Food Units - Temperature Adjustment	Page 16
e-Cleaning The Interior	Page 6	VIII. SPARE & REPLACEMENT PARTS LISTING	Page 17-18
f-Adjusting The Shelves	Page 6	IX. TROUBLESHOOTING GUIDE	Page 19
		X. WARRANTY INFORMATION	Page 20
		XI. NOTES	Page 21
		XII. INDEX	Page 22



FORT WORTH, TX.

SERIAL VOLTS	MODEL Hz	PH	
TOTAL CURRENT	AMPS		
MINIMUM CIRCUIT	AMPS		
MAXIMUM OVERCURRENT PROTECTION			AMPS
LIGHTS	WATTS		
HEATERS	AMPS		
REFRIGERANT DESIGN PRESSURE		TYPE HIGH	OZ LOW
REFRIGERANT DESIGN PRESSURE		TYPE HIGH	OZ LOW

370-60294-00 REV (A)

I. THE SERIAL TAG

The serial tag is a permanently affixed label upon which is recorded vital electrical and refrigeration data about your Traulsen product, as well as the model and serial number. This tag is located in the upper right interior compartment on all Traulsen G-Series refrigerator and freezer models.

READING THE SERIAL TAG

- Serial = The permanent ID# of your Traulsen
- Model = The model # of your Traulsen
- Volts = Voltage
- Hz = Cycle
- PH = Phase
- Total Current = Maximum amp draw
- Minimum Circuit = Minimum circuit ampacity
- Lights = Light wattage
- Heaters = Heater amperage (Hot Food units only)
- Refrigerant = Refrigerant type used
- Design Pressure = High & low side operating pressures and refrigerant charge
- Agency Labels = Designates agency listings

II. RECEIPT INSPECTION

All Traulsen products are factory tested for performance and are free from defects when shipped. The utmost care has been taken in crating this product to protect against damage in transit. All interior fittings have been carefully secured and the legs are boxed and strapped inside to prevent damage. Door keys will be attached to the handle with a nylon strip. The handle is protected by an easily removable nylon netting.

You should carefully inspect your Traulsen unit for damage during delivery. If damage is detected, you should save all the crating materials and make note on the carrier's Bill Of Lading describing this. A freight claim should be filed immediately. If damage is subsequently noted during or immediately after installation, contact the respective carrier and file a freight claim. Under no condition may a damaged unit be returned to Traulsen & Co. without first obtaining written permission (return authorization).

III. INSTALLATION

III. a - LOCATION:

Select a proper location for your Traulsen unit, away from extreme heat or cold. Allow enough clearance between the unit and the side wall in order to make use of the door stay open feature at 120° (self-closing feature operates up to 90°). The door(s) must be able to open a minimum of 90° in order to make use of the maximum clear door width available.

III. b - PACKAGING:

All Traulsen units are shipped from the factory bolted to a sturdy wooden pallet and packaged in a durable cardboard container. The carton is attached to the wooden skid with the use of large staples. These should first be removed to avoid scratching the unit when lifting off the crate.

Most exterior stainless steel surfaces have a protective vinyl covering to prevent scratching during manufacturing, shipping and installation. After the unit is installed in place of service, remove and discard the covering from all surfaces.

To remove the wooden pallet, first if at all possible, we suggest that the cabinet remain bolted to the pallet during all transportation to the point of final installation. The bolts can then be removed with a 3/4" socket wrench. Avoid laying the unit on its front, side or back for removal of the pallet.

NOTE: Traulsen does not recommend laying the unit down on its front, side or back. However, if you must please be certain to allow the unit to remain in an upright position afterwards for 24 hours before plugging it in so that the compressor oils and refrigerant may settle.

III. INSTALLATION (continued)

III. c - INSTALLING CASTERS OR LEGS:

A set of four (4) 6" high casters are supplied standard for all Traulsen G-Series units. These are shipped from the factory packed inside a cardboard box which is strapped inside the cabinet to the lower shelf. Inside it should contain four (4) casters and sixteen (16) bolts.

Legs in lieu of casters are available as an optional accessory kit for the same models. These are shipped inside a separate cardboard box. Inside it should contain four (4) legs.

WARNING: THE CABINET MUST BE BLOCKED AND STABLE BEFORE INSTALLING LEGS OR CASTERS.

To install the legs or casters, first raise and block the reach-in a minimum of 7" from the floor. For installing legs, thread the legs into the threaded holes on the bottom of the cabinet (see figure 1). Be certain that all legs are tightly secured. When the unit is set in its final position, it is important for proper operation that the unit be level. The legs are adjustable for this purpose, turn the bottom of the leg counterclockwise to raise it, clockwise to lower it. Level the unit from front to back as well as side to side in this manner, using a level placed in the bottom of the cabinet.

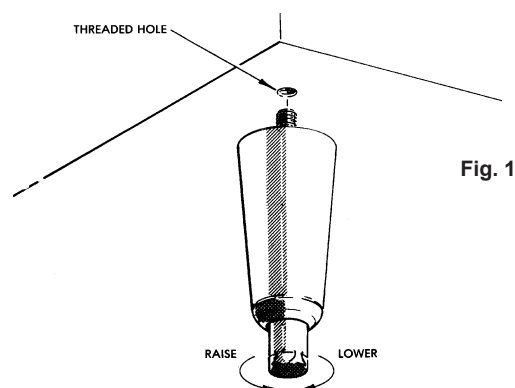

Please note that Traulsen units are not designed to be moved while on legs. If the unit requires moving, a pallet jack or forklift should be used to prevent damage. For installing casters, the casters are "plate" type, and require the use of four (4) bolts each to secure them firmly to the cabinet bottom at each corner (see figure 2). The caster bolts are tightened using a 1/2" socket wrench.

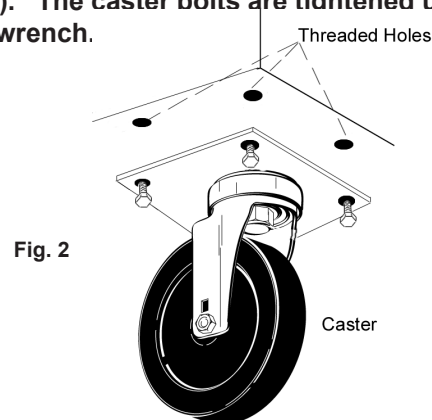

III. INSTALLATION (continued)

III. d - SHELF PINS:

The unit is supplied with shelves and shelf pins installed. Check all shelf pins to assure they are tightened down as they may have come loose during shipping. Rotate the pins clockwise until they are secured against the side of the cabinet.

III. e - REMOVING THE DOORS & HARDWARE:

In order to fit through narrow (less than 35") doorways, it may be sometimes be necessary to remove the door(s), and/or hinges. To remove any solid door, begin by removing the plug at the bottom of the top hinge. Inside the hinge there is a small screw which secures the door in place. Remove this with a flat head screwdriver and the door can then be lifted off the hinge (see figure 3).

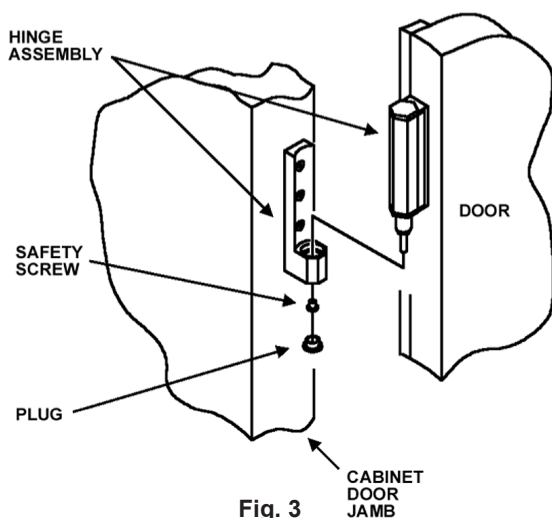

Fig. 3

After removing the door, it is now necessary to remove the hinge assembly and hardware from the door itself.

To remove the door portion of the hinge from the door, lift off the hinge cover and then remove the three Phillips head screws which secure the hinge in place on the door (see figure 4).

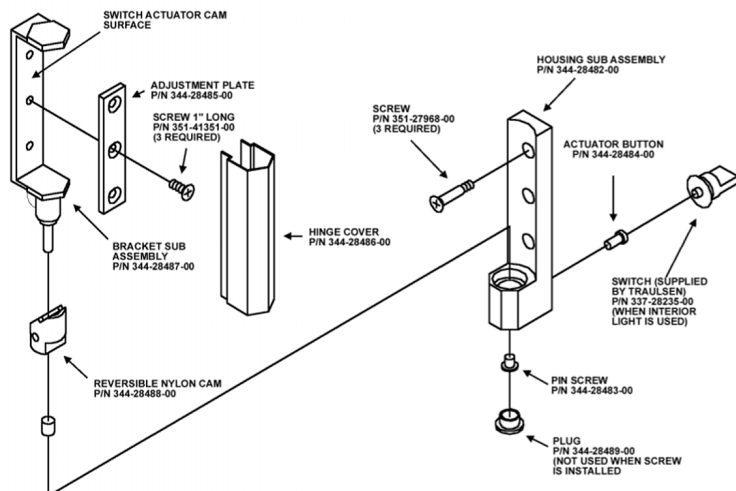

Fig. 4

III. e - REMOVING THE DOORS & HARDWARE (cont'd):

If it is also necessary to remove the hinge hardware from the cabinet as well, begin by removing the three Phillips head screws which hold it in place. Set these components aside for later reassembly (see figure 4).

NOTE: All solid door units include a microswitch for controlling the interior lighting in the top hinge(s). Special care should be taken to not damage the wiring for this during the hinge removal process.

The lock keeper will also need to be removed in order to reduce the overall cabinet depth to 32".

Begin by removing the two (2) Phillips head screws which secure the lock keeper actuator to the lock keeper bracket.

Next remove the lock keeper bracket by removing the two (2) flat head screws which secure it in place. Set these components aside for later reassembly.

To re-install the door and/or hinges, please reverse the appropriate sections of the preceding procedure.

III. f - CORD & PLUG:

All G-Series models are supplied with a cord & plug attached. It is shipped coiled at the top of the cabinet, secured by a nylon strip. For your safety and protection, all units supplied with a cord and plug include a special three-prong grounding plug on the service cord. Select only a dedicated electrical outlet with grounding plug for power source. **NOTE:** Do not under any circumstances, cut or remove the round grounding prong from the plug, or use an extension cord.

III. g - POWER SUPPLY:

The supply voltage should be checked prior to connection to be certain that proper voltage for the cabinet wiring is available (refer to the serial tag to determine correct unit voltage). Make connections in accordance with local electrical codes. Use qualified electricians.

Use of a separate, dedicated circuit is required. Size wiring to handle indicated load and provide necessary overcurrent protector in circuit (see amperage requirements on the unit's serial tag).

III. h - WIRING DIAGRAM:

Refer to the wiring diagram for any service work performed on the unit. Should you require one, please contact Traulsen Service at (800) 825-8220, and provide the model and serial number of the unit involved.

III. INSTALLATION (continued)

III. i - CLEARANCE:

In order to assure optimum performance, the condensing unit of your Traulsen unit **MUST** have an adequate supply of air for cooling purposes. Therefore, the operating location must either have a minimum of 12" clearance overhead of the condensing unit or allow for unrestricted air flow at the back of the unit. Clearance of at least 12" above is required in order to perform certain maintenance tasks.

III. j - INSTALLING OPTIONAL INTERIOR KITS:

In addition to their standard interiors, G-Series models also offer the option for additional shelves or tray slides. If ordered, these are shipped as kits along with the unit, packaged in a separate cardboard box which contains all the necessary parts and hardware for on-site installation.

To install additional shelves, first remove the white plastic covers from inside the cabinet. These are located along the same vertical line as the pins already in place on the interior side walls, back and center mullion (two and three-section models). This exposes threaded holes in which you may position the new shelves. Next insert the gray plastic shelf pins into these holes and tighten by turning clockwise with your fingers. After all four pins are in place, the new shelf should be placed to rest on top of them. The unused plastic covers may be discarded or saved for future changes to the cabinet interior.

Installation of optional tray slides varies with each cabinet, and with each type of tray slide ordered. To install optional tray slides, follow the directions packaged inside the kit carton.

III. k - ON/OFF SWITCH:

An ON/OFF toggle switch for the power supply is provided. It is located on top of the unit, mounted to the side of the evaporator housing. This is shipped from the factory in the ON position.

IV. OPERATION

IV. a - REFRIGERATORS:

Both refrigerators and freezers do not require manual defrosting. During normal operation, a refrigerator continuously circulates above freezing cabinet air through the coil. A compressor "OFF" cycle occurs every hour to melt any frost which may accumulate on the coil during the compressor "ON" cycle. The control will read "dEF" when this occurs. With standard holding refrigerators, high relative humidity is also maintained to prevent dehydration of stored product.

IV. OPERATION (continued)

IV. b - FREEZERS:

During normal operation, a freezer continuously circulates below freezing cabinet air through the coil. The coil requires a periodic defrosting for proper operation. This is accomplished by an automatic, time activated, temperature/time terminated, defrost program. The controller is preset at the factory for six equally spaced defrost cycles within each 24-hour period.

At the start of a freezer defrost cycle, both the compressor and evaporator fans are off. The microprocessor control will read "dEF" (see figure 5).

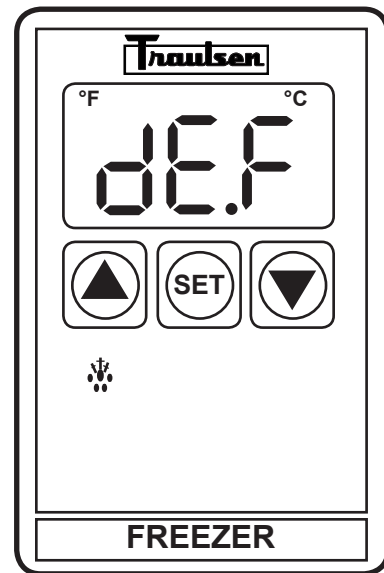

Fig. 5

The electric heater (attached to the coil) is energized. When a temperature device affixed to the coil senses 70°F (models with electric defrost), the coil is fully defrosted and the compressor operation is resumed, defrost heaters are automatically turned off. The coil fans are delayed from starting at the termination of a defrost cycle. Fan operation is automatically resumed, or they can also be started by a time or temp delay (whichever comes first). In case of temp delay, it uses the same coil sensor and starts at 32°F. The total refrigeration system operation is then resumed. During freezer defrost operation, heat is confined to the coil enclosure to prevent any significant rise in temperature within the food zone. The fan delay controls function upon termination of a defrost cycle is two-fold. First, to prevent blowing warm air into the food storage area. Second, to prevent any condensation on the defrost coil from being blown into the food storage area.

The microprocessor control is set from the factory to terminate defrost at 20 minutes in the event of a sensor failure. This setting should never be tampered with, without first consulting the factory.

IV. OPERATION (continued)

IV. c - LIGHT SWITCHES:

All G-Series models include a concealed light switch mounted in the top door hinge(s), which automatically activates the interior light when the door is opened. When the door is closed, the lights are not operating.

In addition, on hinged glass door models, an exterior mounted, illuminated red switch is included for manual light control. In the ON position, the lights are illuminated whether the doors are open or not. In the OFF position, the lights are controlled by the hinge switch as described in the first paragraph.

IV. d - SPECIAL DISPLAY OPERATING MODE:

G-Series models built during the summer of 2009 and beyond will include a special control mode which disables the external temperature display. Note that before doing so you must install an interior mounted thermometer in order to conform with local health codes.

To initiate this mode press the up and down arrows simultaneously for 1 second until the temperature display goes blank. The temperature display will remain disabled indefinitely until such time as the operator wishes to restore normal operation. To do so simply repeat the process of pressing the up and down arrows simultaneously for 1 second until the temperature display illuminates.

Note that in the event power is interrupted for any reason the display will return to standard operating mode where it displays the correct cabinet air temperature.

V. CARE & MAINTENANCE

WARNING: DISCONNECT ELECTRICAL POWER SUPPLY BEFORE CLEANING ANY PARTS OF THE UNIT.

V. a - CLEANING THE CONDENSER:

The most important thing you can do to insure a long, reliable service life for your Traulsen is to regularly clean the condenser coil.

The condensing unit requires regularly scheduled cleaning to keep the finned condenser clean of lint and dust accumulation. Keeping the condenser clean allows the cabinet to operate more efficiently and use less energy. To clean the condenser, first disconnect electrical power to the cabinet and lift up the front louver assembly. To lift this, remove the two screws located on both sides at the bottom of the louver assembly (see figure 5). Once the screws are removed, the panel can be pivoted upwards allowing full access to the front facing condenser (see figure 6).

Vacuum or brush any dirt, lint or dust from the finned condenser coil, the compressor and other cooling

V. CARE & MAINTENANCE (cont'd)

V. a - CLEANING THE CONDENSER (cont'd):

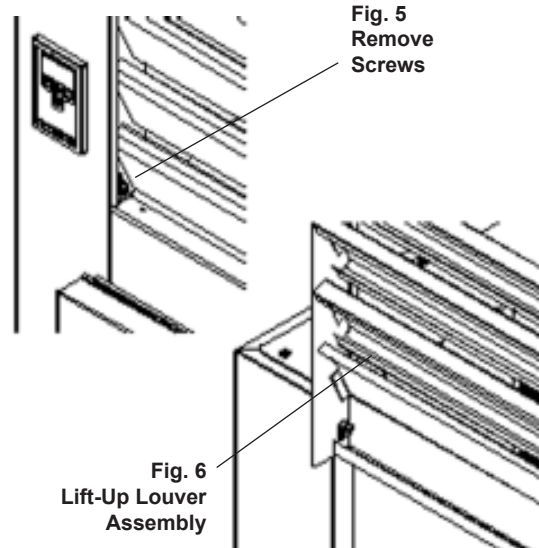

system parts. If significant dirt is clogging the condenser fins, use compressed air to blow this clear. Care should be taken not to bend any of the condenser fins, as this will reduce performance and compressor life. Lower louver assembly and replace screws to hold it in place.

V. b - HINGE REPLACEMENT:

To remove the door, remove the plug at the bottom of the top hinge. Behind this is a screw which secures the door in place. Remove this with a flat head screwdriver and then lift the door off the hinge. To remove the door portion of the hinge, lift off the hinge cover and then remove the 3 x Phillips head screws which secure the hinge in place. To remove the cabinet portion of the hinge, remove the 3 x Phillips head screws which hold it in place. On solid door units, the top hinge(s) contains a switch for controlling the lights.

To reassemble the hinge reverse the procedure.

V. c - REPLACING THE GASKETS:

To remove the gasket to be replaced, grasp it firmly by one corner and pull it out. Before attempting to install a new gasket, both the unit and gasket must be at room temperature. Insert the four corners first by using a rubber mallet (or hammer with a block of wood). After the corners are properly inserted, work your way towards the center from both ends by gently hitting with a mallet until the gasket is completely seated in place (see figure 7 for proper gasket placement⁴).

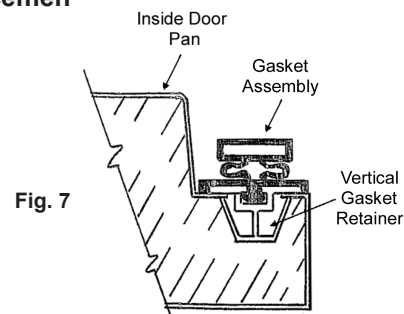

V. CARE & MAINTENANCE (cont'd)

V. d - CLEANING THE EXTERIOR:

Exterior stainless steel should be cleaned with warm water, mild soap and a soft cloth. Apply with a dampened cloth and wipe in the direction of the metal grain.

Avoid the use of strong detergents and gritty, abrasive cleaners as they may tend to mar and scratch the surface. Do NOT use cleansers containing chlorine, this may promote corrosion of the stainless steel.

Care should also be taken to avoid splashing the unit with water, containing chlorinated cleansers, when mopping the floor around the unit.

For stubborn odor spills, use baking soda and water (mixed to a 1 TBSP baking soda to 1 pint water ratio).

V. e - CLEANING THE INTERIOR:

For cleaning anodized aluminum interiors, the use of baking soda as described in section "V. d" is recommended. Use on breaker strips as well as door gaskets. All interior fittings are removable without tools to facilitate cleaning.

V. f - ADJUSTING THE SHELVES:

For shelves mounted on pins, first select the desired location and remove the white plastic covers in the interior back and sides by rotating them counter-clockwise. Remove the shelf pins by rotating them counter-clockwise. Install the pins in the desired location by rotating clockwise. Make sure the pin is securely tightened down. Do not over tighten. Slide the shelf into its new position, and replace the white plastic covers into the holes vacated by the shelf pins.

VI. OTHER

VI. a - SERVICE INFORMATION:

VI. OTHER (cont'd)

VI. a - SERVICE INFORMATION (cont'd):

- Is the electrical cord plugged in?
- Is the fuse OK or circuit breaker on?
- Is the power switch "ON"?

If after checking the above items and the unit is still not operating properly, please contact an authorized Traulsen service agent. A complete list of authorized service agents was provided along with your Traulsen unit. If you cannot locate this, you may also obtain the name of a service agent from the Tech Service page of our website: www.traulsen.com.

If service is not satisfactory, please contact our in-house service department at:

Traulsen
4401 Blue Mound Road
Fort Worth, TX 76106
(800) 825-8220

Traulsen reserves the right to change specifications or discontinue models without notice.

VI. b - SPARE PARTS:

Spare or replacement parts may be obtained through a parts supplier or one of our authorized service agents. A complete list of authorized service agents accompanies this manual and is also posted on our company's official website @ www.traulsen.com.

VI. c - WARRANTY REGISTRATION:

The warranties for your new Traulsen unit may be registered with us by completing the enclosed warranty card (shipped with the unit).

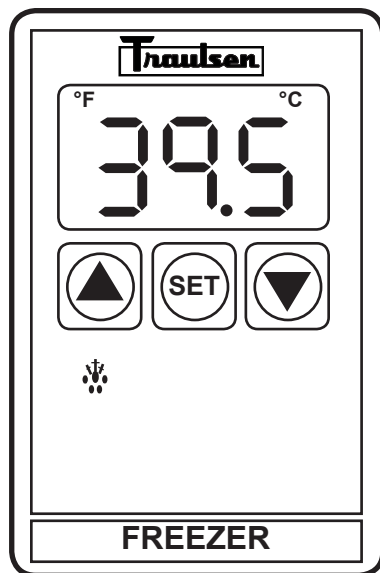

VII. MICROPROCESSOR CONTROL

Your new Traulsen G-Series Refrigerator or Freezer is equipped with an electronic microprocessor control, which precisely regulates operation. It is supplied from the factory completely ready for use. See pages 6 thru 15 for more information.

VIII. a - MICROPROCESSOR CONTROL FEATURES:

Internal Time Clock

- Eliminates defrost time clock (refrigerator and freezer models only).
- Will display only at "Start Up".
- Battery Back-up (eliminates the need to reset the control after a power failure).
- See "Setting The 24-Hour Clock" on Page 11. (Also required at "Start Up")
- Will automatically update for Daylight Savings Time. See "Setting Daylight Savings Time" on page 12.

VII. MICROPROCESSOR CONTROL (continued)

VII. a - MICROPROCESSOR CONTROL FEATURES (cont'd):

Water Resistant Housing

The digital controller is water resistant not only from the face of the control, but also from the rear of the housing.

Parameter/Service Levels

• See “Customer/Service Parameters” on Page 8 - 9.

Defrost Lockouts - See “Setting Defrost Lockouts” on page 14

• Customers can set up to 4 different defrost lockout periods. The lockout prevents the unit from going into a defrost cycle during peak kitchen use. Note: The 24-hour clock must be set for this feature to operate correctly.

VII. b - CONTROL PANEL:

LED For ° F

3-Digit (red) LED Display

Defrost Icon With LED

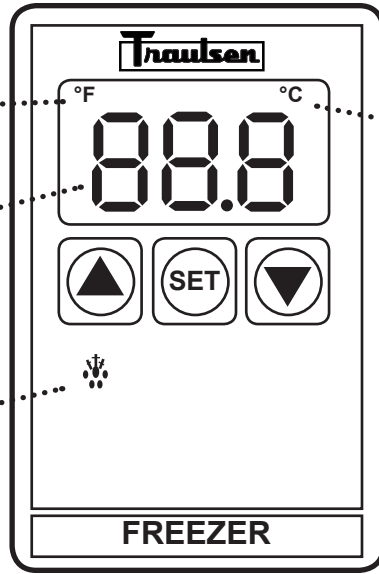

LED For °C

*= Can be ordered separately

**=Requires unit Model No. & S/N to place order.

VII. c - PARTS ASSEMBLY:

COIL SENSOR*
337-60071-02
(freezer models only)

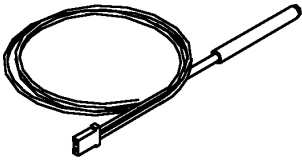

CABINET SENSOR*
337-60069-02

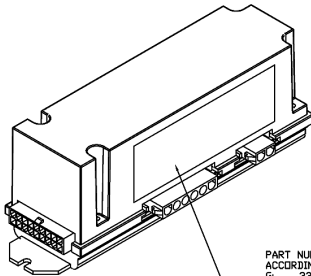
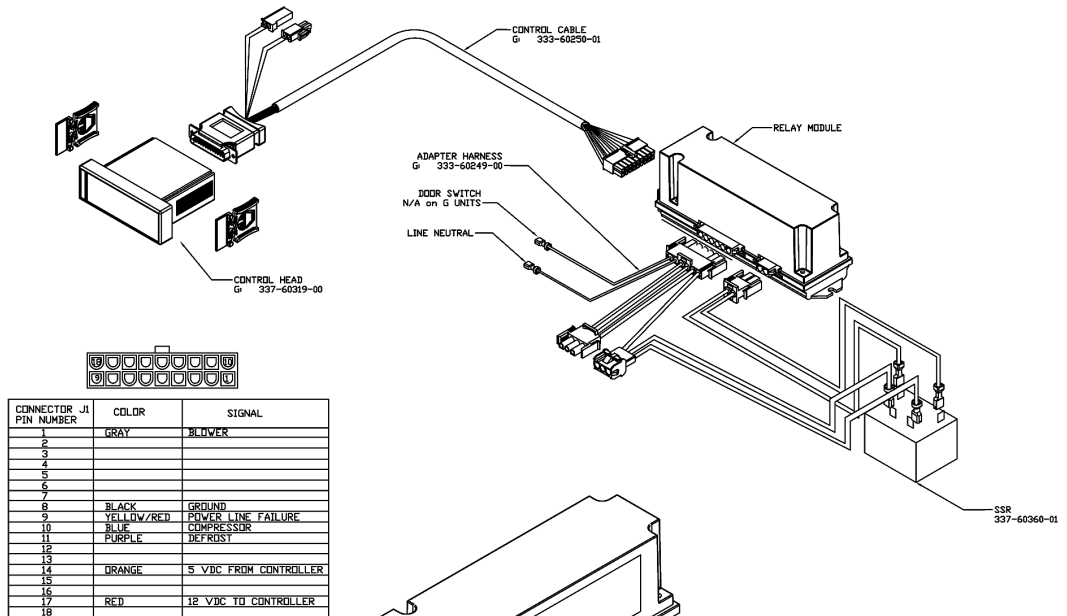
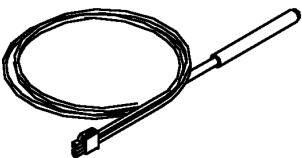

PART NUMBERS WILL VARY ACCORDING TO MODEL TYPE
G: 337-60367-00

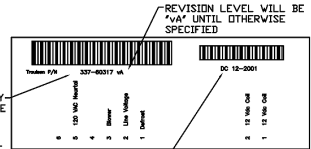

DATE CODE WILL BE LISTED AS THE WEEK-YEAR (01-02)-(2001-2100) WHEN THE CONTROL IS MANUFACTURED

VII. MICROPROCESSOR CONTROL (continued)



VII. d - NOTES TO THE USER:

You only have 20-30 seconds between button pushes. If you take longer than 30 seconds, the controller will revert back to displaying the cabinet temperature. If you enter the wrong security code, the controller will revert back to displaying the cabinet temperature. You can exit the parameters at any time by waiting 20-30 seconds for the control to return to normal operation.

VII. e - ENTER THE CUSTOMER ACCESS:

This is required to set any of the control parameters.

Use the security code “0, A, 1”  and the following instructions:

Press the set button  . The display will read  Customer/Service Access.

Press the set button  .

The display will show three zeros with the left zero flashing  .

Press the set button  .

The display will show three zeros with the center zero flashing  .

Press the down arrow key  to sequence through F, E, d, C, b, A, 9, 8, 7,...etc.

When you reach “A” press set  .

The display will show “zero, A, zero” with the right zero flashing  .

Press the up arrow key  to sequence through 1, 2, 3, 4, 5, 6, 7, 8, 9, A, b,...etc.

When you reach “1” press set  .















The display will read  Thermostat Set Point High.

You are now in the **CUSTOMER / SERVICE PARAMETERS.**

VII. MICROPROCESSOR CONTROL (continued)

VII. f - CUSTOMER SERVICE PARAMETERS:

Listed below are the available parameters in the order they appear, using the down arrow key on the controller. You can use either the up or down arrow keys to scroll through the options.



	Thermostat Set Point High*		Defrost Lockout 2
	Thermostat Set Point Low		Defrost Lockout 3
	Temperature Scale		Defrost Lockout 4
	Time (24-hour clock)		Room Temperature Offset
	Date (month - day - year)		Evaporator Coil Sensor Temperature
	Daylight Savings		Dewpoint Compensation Factor (n/a on G-Series models)
	Start Manual Defrost		Cabinet Air Temperature
	Defrost Lockout 1		

VII. g - ADJUSTING THE THERMOSTAT SET POINT HIGH:

This parameter sets the high point of the desired cabinet temperature range. Typically, freezers will range from -3° F to 0° F (-19° C to -18° C) and refrigerators will range from 36° F to 40° F (2° C to 4° C) for this parameter setting. This parameter is preset at the factory and does not have to be adjusted unless the customer chooses to do so. Note: Set Point Low and Set Point High **cannot** be set to the same temperature. There will be at least 1-2 degree difference between the two settings.



Follow the instructions to enter the customer access code on page 8. When the control

display reads  Thermostat Set Point High. Press the set button .

Use the arrow keys   to adjust the temperature to your desired setting.

When the display shows the temperature you want press the set button .

The display will then read  Thermostat Set Point High.

You can use the up or down arrow keys to scroll to the next parameter  





or wait 30 seconds for the control to return to normal operation.



VII. MICROPROCESSOR CONTROL (continued)

VII. h - ADJUSTING THE THERMOSTAT SET POINT LOW:

This parameter sets the low point of the desired cabinet temperature range. Typically, freezers will range from -6° F to -4° F (-21° C to -20° C) and refrigerators will range from 32° F to 34° F (0° C to 1° C) for this parameter setting. This parameter is preset at the factory and does not have to be adjusted unless the customer chooses to do so. Note: Set Point Low and Set Point High **cannot** be set to the same temperature. There will be at least 1-2 degree difference between the two settings.



Follow the instructions to enter the customer access code on page 8. When the control

displays  Thermostat Set High, press the down arrow key  until the control display reads  Thermostat Set Point Low. Press the set button .

Use the arrow keys   to adjust the temperature to your desired setting.

When the display shows the temperature you want press the set button .

The display will then read  Thermostat Set Point Low.





You can use the up or down arrow keys to scroll to the next parameter  





or wait 30 seconds for the control to return to normal operation.

VII. i - Changing The Temperature Scale:

The temperature scale determines if the temperature displayed will be in degrees Fahrenheit or degrees Celsius.

Follow the instructions to enter the customer access code on page 8. When the control

displays  Thermostat Set High, press the down arrow key  until the control display reads  Temperature Scale. Press the set button .

The display will start with the current setting either  for degrees Fahrenheit or  for degrees Celsius. Use the arrow keys   to toggle between the options.

When the display shows the scale you want press the set button .

The display will then read  Temperature Scale.

You can use the up or down arrow keys   to scroll to the next parameter

or wait 30 seconds for the control to return to normal operation.



VII. MICROPROCESSOR CONTROL (continued)



VII. j - SETTING THE 24-HOUR CLOCK:

The internal timeclock must be set in order for the data storage memory to correctly log events and to allow any defrost lock out to occur at the correct time of day. If the clock is not set, the control assumes the time is 12 a.m. at the time power is supplied to the unit. The hours on a 24-hour timeclock read the following way:

H01 = 1:00 a.m.	H07 = 7:00 a.m.	H13 = 1:00 p.m.	H19 = 7:00 p.m.
H02 = 2:00 a.m.	H08 = 8:00 a.m.	H14 = 2:00 p.m.	H20 = 8:00 p.m.
H03 = 3:00 a.m.	H09 = 9:00 a.m.	H15 = 3:00 p.m.	H21 = 9:00 p.m.
H04 = 4:00 a.m.	H10 = 10:00 a.m.	H16 = 4:00 p.m.	H22 = 10:00 p.m.
H05 = 5:00 a.m.	H11 = 11:00 a.m.	H17 = 5:00 p.m.	H23 = 11:00 p.m.
H06 = 6:00 a.m.	H12 = 12:00 p.m.	H18 = 6:00 p.m.	H24 = 12:00 a.m.

Follow the instructions to enter the customer access code on page 8. When the control

displays  Thermostat Set High, press the down arrow key  until the control



display reads  Clock. Press the set button .

The display will show  Hours. The right two numbers will be flashing.

Use the arrow keys   to set the hour.

When the correct hour is displayed, press the set button .

The display will show  Minutes. The right two numbers will be flashing.

Use the arrow keys   to set the minutes.

When the correct minutes are displayed, press the set button .



















The display will then read  Clock.

You can use the up or down arrow keys   to scroll to the next parameter













or wait 30 seconds for the control to return to normal operation.

VII. MICROPROCESSOR CONTROL (continued)

VII. k - SETTING THE DATE:

The date must be set in order for the data storage memory to correctly log events. Follow the instructions to enter the customer access code on page 8. When the control displays  Thermostat Set Point High, press the down arrow key  until the control display reads  Date. Press the set button . The display will show  (year). The right two numbers will be flashing. Press the arrow keys   to set the year. When the correct year is displayed, press the set button . The display will show  (month). The right two numbers will be flashing. Use the arrow keys   to set the month. When the correct month is displayed, press the set button . The display will show  (day). The right two numbers will be flashing. Press the arrow keys   to set the day. When the correct day is displayed, press the set button . The display will then read  Date. You can use the up or down arrow keys   to scroll to the next parameter, or wait 30 seconds for the control to return to normal operation.

VIII. I - SETTING DAYLIGHT SAVINGS TIME:



This parameter is preset at the factory to automatically adjust the 24-hour clock for Daylight Savings Time. Follow the instructions to enter the customer access code on page 8. When the control displays  Thermostat Set Point High, press the down arrow key  until the display reads  Daylight Savings Time. Press the set button . The display will show  Daylight Savings Time (Yes, automatically adjust for Daylight Savings Time). For “YES,” press the set button , for “NO” press the up or down arrow key  . The display will read  Daylight Savings Time (no). Press the set button . The display will read  Daylight Savings Time. You can press the the up or down arrow keys   to scroll to the next parameter or wait 30 seconds for the control to return to normal operation.

VII. MICROPROCESSOR CONTROL (continued)

VII. m - STARTING A MANUAL DEFROST CYCLE:

This parameter allows a service technician to start a defrost cycle at any time. This parameter will override any lockout settings.



Follow the instructions to enter the customer access code on page 8. When the control

displays  Thermostat Set High, press the down arrow key  until the control

display reads  Start Manual Defrost.

Press the set button .

The display will show  (OFF).

Press either arrow key   (ON).

The display will show .

Press the set button .

The display will then read  Start Manual Defrost.

You can use the up or down arrow keys   to scroll to the next parameter

or wait 30 seconds for the control to return to normal operation.

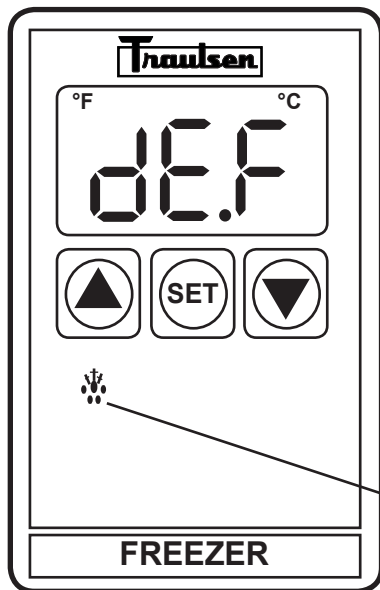

The defrost icon will be lit, and the display will read







DEFROST ICON

NOTE: Traulsen refrigerator units also have an off-cycle defrost once an hour, at which time the control will read . This defrost cycle is time or temperature terminated and generally lasts from 3 - 10 minutes in duration (time terminated only on refrigerator models).

VII. MICROPROCESSOR CONTROL (continued)

VII. n - SETTING THE DEFROST LOCKOUTS:



The defrost lockout parameters allow the customer to prevent the unit from going into a defrost cycle for two hours during a set timeframe. Customers can set up to four defrost lockout parameters. They are all programmed the same way. The parameters will be set for the time the lockout is to start. The controller automatically calculates 2 hours from that setting. The options are similar to the 24-hour clock settings and are in 30-minute increments. Each of the lockout parameters covers 6 hours of the 24-hour clock. Note: The 24-hour clock must be set for this feature to operate at the correct time of day. See “**Setting the 24-Hour Clock**” on page 11.

				
	OFF	OFF	OFF	OFF
	020 = 2:00 a.m.	080 = 8:00 a.m.	140 = 2:00 p.m.	200 = 8:00 p.m.
	023 = 2:30 a.m.	083 = 8:30 a.m.	143 = 2:30 p.m.	203 = 8:30 p.m.
	030 = 3:00 a.m.	090 = 9:00 a.m.	150 = 3:00 p.m.	210 = 9:00 p.m.
	033 = 3:30 a.m.	093 = 9:30 a.m.	153 = 3:30 p.m.	213 = 9:30 p.m.
	040 = 4:00 a.m.	100 = 10:00 a.m.	160 = 4:00 p.m.	220 = 10:00 p.m.
	043 = 4:30 a.m.	103 = 10:30 a.m.	163 = 4:30 p.m.	223 = 10:30 p.m.
	050 = 5:00 a.m.	110 = 11:00 a.m.	170 = 5:00 p.m.	230 = 11:00 p.m.
	053 = 5:30 a.m.	113 = 11:30 a.m.	173 = 5:30 p.m.	233 = 11:30 p.m.
	060 = 6:00 a.m.	120 = 12:00 p.m.	180 = 6:00 p.m.	240* = 12:00 a.m.
	063 = 6:30 a.m.	123 = 12:30 p.m.	183 = 6:30 p.m.	243* = 12:30 a.m.
	070 = 7:00 a.m.	130 = 1:00 p.m.	190 = 7:00 p.m.	010 = 1:00 a.m.
	073 = 7:30 a.m.	133 = 1:30 p.m.	193 = 7:30 p.m.	013 = 1:30 a.m.
	080 = 8:00 a.m.	140 = 2:00 p.m.	200 = 8:00 p.m.	020 = 2:00 a.m.



* Denotes not available.

A lockout cannot be programmed to start at 12:00 a.m. or 12:30 a.m. due to conflicts with other internal programs. The defrost lockouts cannot be programmed to run back-to-back. For example, if dL1 is set to 080, then a defrost cycle would be locked out from 8:00 a.m. to 10:00 a.m. Because of the dL1 setting the dL2 parameter would not let the user choose a lockout start time before 10:30 a.m. All lockouts are preset at the factory to OFF.

Follow the instructions to enter the customer access code on page 8. When the control

displays  Thermostat Set High, press the down arrow key  until the control the

control display reads    or  . Press the set button  .

The display will show  Off. Press the arrow keys   to set the start time.

When the correct time is displayed, press the set button  .

The display will then read  Thermostat Set Point High.

You can press the up or down arrow keys   to scroll to the next parameter

or wait 30 seconds for the control to return to normal operation.

VII. MICROPROCESSOR CONTROL (continued)



VII. o - ADJUSTING THE ROOM TEMPERATURE OFFSET:

The room temperature offset parameter allows a service technician or end user the ability to have the display show a temperature that is within three degrees of the actual temperature being read by the cabinet air sensor. This allows for continuity of reading between different temperature reading devices. (i.e.: thermistor Vs thermocouple Vs handheld thermometer) This parameter is preset at the factory to "0" or no offset.

Follow the instructions to enter the customer access code on page 8. When the control displays

 Thermostat Set High, press the down arrow key  until the control display reads 







Room Temperature Offset. Press the set button . Use the arrow keys   to adjust the offset to your desired setting. When the display shows the offset you want press the set button .

The display will then read  Room Temperature Offset. You can use the up or down arrow keys   to scroll to the next parameter or wait 30 seconds for the control to return to normal operation.

VII. p - VIEWING SENSOR TEMPERATURES:

These parameters allow a service technician or customer to view the temperature of all sensors within the unit. The temperatures cannot be adjusted.

Follow the instructions to enter the customer access code on page 8. When the control displays

Thermostat Set Point High , press the DOWN arrow key  until the display reads Evaporator Coil Sensor  or Cabinet Air  or press the SET button . The display will read Thermostat Set Point High .

Press the UP or DOWN arrow keys   to scroll through the parameters or wait 30 seconds for the control to return to normal operation.

VII. MICROPROCESSOR CONTROL (continued)



VII. q - HOT FOOD UNITS, ADJUSTING THE THERMOSTAT & TURNING THE UNIT OFF/ON:



This parameter sets the desired cabinet temperature. Please note that hot food units are delivered from the factory set to the OFF position.

Follow the instructions to enter the customer access code on page 8. When the control reads

SPH



Thermostat Set Point High, press the set button .

Use the arrow keys   to adjust the temperature to your desired setting. When the display shows the temperature you want press the set button .





The display will then read **SPH** Thermostat Set Point High. You can use the up or down   arrow keys to scroll to the next parameter or press the alarm cancel button  to exit.

VII. r - HOT FOOD UNITS, TURNING THE UNIT OFF/ON:

After the temperature has been set, the customer can continuously turn the unit OFF and then back ON to the same temperature. To turn the unit ON /OFF press the alarm cancel button , (please note that this feature is not available on versions of the control manufactured prior to September 2000), or if an alarm warning condition is present, use the alternative ON/OFF activation method.

To turn the unit ON/OFF using the alternative method, press both arrows   at the same time, the set temperature will remain in memory.

VII. s - HOT FOOD UNITS, TEMPERATURE ADJUSTMENT:

Press the **SET** button  and the **UP ARROW** button  at the same time. The display will flash the current temperature setting or **OFF** (if the unit is turned off). Use the **UP**  or **DOWN ARROW**  buttons to adjust your desired temperature setting (temperature range is 140° thru 180° F, and OFF) then press the **SET** button . The display will go back to reading cabinet temperature. If **OFF** is selected, the display will then read **OFF**. **NOTE:** If you wish to change the set temperature at anytime follow this procedure.

These models also include a “One-Time Temperature Setting Adjustment” feature. Upon start-up, the unit will warm-up to the last temperature you had set for it, unless changed.

VIII. SPARE & REPLACEMENT PARTS LISTING

	G100/G110	G120XX	G200/G210	G220XX	G300/G320	G313XX/G310XX
	1 SEC REF	1 SEC FRZ	2 SEC REF	2 SEC FRZ	3 SEC REF	3 SEC FRZ
FULL HEIGHT SOLID DOOR	200-60142-00	200-60142-00	200-60142-00	200-60142-00	200-60142-00	200-60142-00
FULL HEIGHT GLASS DOOR	200-42192-00	N/A	200-42192-00	N/A	200-42192-00	N/A
HALF HEIGHT SOLID DOOR ¹	200-60140-00	200-60140-00	200-60140-00	200-60140-00	200-60140-00	200-60140-00
HALF HEIGHT GLASS DOOR ¹	200-60141-00	N/A	200-60141-00	N/A	200-60141-00	N/A
HALF HEIGHT SOLID DOOR ²	200-60140-01	200-60140-01	200-60140-01	200-60140-01	200-60140-01	200-60140-01
HALF HEIGHT GLASS DOOR ²	200-60141-01	N/A	200-60141-01	N/A	200-60141-01	N/A
FULL HEIGHT SOLID DOOR GASKET	341-60059-00	341-60059-00	341-60059-00	341-60059-00	341-60059-00	341-60059-00
HALF-HEIGHT SOLID DOOR GASKET	341-60060-00	341-60060-00	341-60060-00	341-60060-00	341-60060-00	341-60060-00
FULL HEIGHT GLASS DOOR GASKET	341-42090-02	N/A	341-42090-02	N/A	341-42090-02	N/A
HALF-HEIGHT GLASS DOOR GASKET	341-42090-01	N/A	341-42090-01	N/A	341-42090-01	N/A
HINGE ASSEMBLY FOR ALL DOORS	SER-28583-00	SER-28583-00	SER-28583-00	SER-28583-00	SER-28583-00	SER-28583-00
LOCKKEEPER	SER-60433-00	SER-60433-00	SER-60433-00	SER-60433-00	SER-60433-00	SER-60433-00
LOCK CYLINDER FOR ALL DOORS	346-13186-42	346-13186-42	346-13186-42	346-13186-42	346-13186-42	346-13186-42
T-42 KEY FOR ABOVE	346-28924-42	346-28924-42	346-28924-42	346-28924-42	346-28924-42	346-28924-42
EPOXY COATED SHELF (pin mounted)	340-60070-02	340-60070-02	340-60074-02	340-60074-02	See Notes ³	See Notes ³
SHELF MOUNTING PIN (4 req'd per shelf)	344-24759-02	344-24759-02	344-24759-02	344-24759-02	344-24759-02	344-24759-02
6" HIGH LEG (4 req'd. per unit)	344-13168-02	344-13168-02	344-13168-02	344-13168-02	344-13168-02	344-13168-02
SET OF FOUR 6" HIGH CASTERS	CK1	CK1	CK1	CK1	CK1	CK1
LOUVER ASSEMBLY	500-70002-00	500-70002-00	500-70008-00	500-70008-00	500-70011-00	500-70011-00
CABINET SENSOR	337-60069-02	337-60069-02	337-60069-02	337-60069-02	337-60069-02	337-60069-02
COIL SENSOR	337-60071-02	337-60071-02	337-60071-02	337-60071-02	337-60071-02	337-60071-02
MICROPROCESSOR CONTROLLER	CONSULT FACTORY FOR PART NUMBER					
LAMPHOLDER	333-60241-00	333-60241-00	333-60241-00	333-60241-00	333-60241-00	333-60241-00
LIGHT COVER	337-30858-00	337-30858-00	337-30858-00	337-30858-00	337-30858-00	337-30858-00
INCANDESCENT LIGHT BULB	378-29776-00	378-29776-00	378-29776-00	378-29776-00	378-29776-00	378-29776-00
HEATER FOR FULL-HEIGHT DOOR	329-60020-13	329-60020-32	329-60020-13	329-60020-32	329-60020-13	329-60020-32
HEATER FOR HALF-HEIGHT DOOR	329-60020-10	329-60020-26	329-60020-10	329-60020-26	329-60020-10	329-60020-26
DEFROST HEATER	N/A	329-60022-00	N/A	329-60021-00	N/A	329-60021-00
EVAPORATOR COIL	322-60003-00	322-60003-00	322-60003-00	322-60020-00	322-60020-00	322-60020-00
EXPANSION VALVE	325-60080-00	325-60080-16	325-60080-00	325-60080-15	325-60080-01	325-60080-02
EVAPORATOR BLOWER ASSEMBLY ⁴	325-60072-02	325-60072-02	325-60071-02	325-60071-02	325-60071-02	325-60071-02
EVAPORATOR MOTOR ASSEMBLY ⁵	433670	433670	433670	433670	325-60071-02	325-60071-02
EVAPORATOR MOTOR ONLY ⁵	430061-2	430061-2	430061-2	430061-2	N/A	N/A
EVAPORATOR FAN BLADE ⁵	433090	433090	433090	433090	N/A	N/A
EVAPORATOR MOTOR BRACKET ⁵	283439	283439	283439	283439	N/A	N/A
PLUNGER SWITCH ⁶	337-28235-00	337-28235-00	337-28235-00	337-28235-00	337-28235-00	337-28235-00
ON/OFF SWITCH	337-60346-00	337-60346-00	337-60346-00	337-60346-00	337-60346-00	337-60346-00
EXTERIOR LIGHT SWITCH ⁷	337-20265-00	N/A	337-20265-00	N/A	337-20265-00	N/A
4 PAIRS #1 TYPE TRAY SLIDES ⁸	TK1	TK1	TK1	TK1	TK1	TK1
2 PAIRS #4 TYPE TRAY SLIDES ⁸	TK2	TK2	TK2	TK2	TK2	TK2
4 PAIRS UNIVERSAL TRAY SLIDES ⁸	TK4	TK4	TK4	TK4	TK4	TK4
3 EPOXY COATED SHELVES ⁹	SK30	SK30	N/A	N/A	SK30 ¹⁰	SK30 ¹⁰
3 EPOXY COATED SHELVES ⁹	N/A	N/A	SK31	SK31	SK31 ¹¹	SK31 ¹¹
3 CHROME PLATED SHELVES ⁹	SK30C	SK30C	N/A	N/A	SK30C ¹⁰	SK30C ¹⁰
3 CHROME PLATED SHELVES ⁹	N/A	N/A	SK31C	SK31C	SK31C ¹¹	SK31C ¹¹
HOT GAS LOOP	326-60102-00	326-60102-00	326-60102-00	326-60099-00	326-60102-00	326-60099-00
WIRING DIAGRAM	379-60385-00	379-60385-00	379-60385-00	379-60385-00	379-60319-00	379-60338-00
REFRIGERANT	R-134a	R-404A	R-134a	R-404A	R-134a	R-404A
COMPRESSOR	AR37C1E-JAA-908	RS43C1E-JAA	AR37C1E-JAA-908	RS54C1E-CAA	RS401E-JAA	KAJB-010E-CAV
RELAY	940-0411-82	040-0102-00	940-0411-82	010-0001-80	040-0102-00	040-0001-48
START CAPACITOR	914-0038-00	014-0008-57	914-0038-00	014-0008-74	014-0008-71	014-0008-63
CONDENSOR FAN MOTOR	050-0258-10	050-0258-10	050-0258-10	050-0267-00	050-0276-00	050-0259-11
CONDENSOR FAN BLADE	083-0122-00	083-0130-00	083-0122-00	083-0133-00	083-0143-00	083-0245-08
CONDENSOR	566-1195-00	066-0336-00	566-1195-00	066-0338-00	066-0338-00	066-0226-00

NOTE

All condensing unit parts are available locally from a Copeland distributor

VIII. SPARE & REPLACEMENT PARTS LISTING - CONTINUED

SPARE & REPLACEMENT PARTS LISTING NOTATIONS

- 1= This half height door can be used as hinged right if mounted on top or hinged left on the bottom.
- 2= This half height door can be used as hinged left if mounted on top or hinged right on the bottom.
- 3= Three section models use a combination of p/n [340-60074-02](#) in the left and right sections, and p/n 340-70-02 in the center section.
- 4= Part number applied to units built between August 2001 and March 2004 only.
- 5= Part numbers apply to units built after March 2004 only.
- 6= Plunger switch is mounted in hinge and used for automatic light operation.
- 7= Available for use with glass door models only.
- 8= If mounting hardware is also required, please specify model and mounting location at time of order to insure provision of correct standards.
- 9= These shelf kits are intended for mounting on pilasters and clips. If mounting hardware is also required, please specify model and mounting location at time of order to insure provision of correct standards.
- 10= Mounting of these shelves is possible in the center section only of three section models.
- 11= Mounting of these shelves is possible in the left and/or right sections only of three section models.

IX. TROUBLE SHOOTING GUIDE

FIND YOUR PROBLEM HERE	REMEDY
1. Condensing unit fails to start.	<ul style="list-style-type: none"> a. Check if cord & plug has been disconnected. b. Check control temperature setting.
2. Condensing unit operates for prolonged periods or continuously.	<ul style="list-style-type: none"> a. Are doors closing properly? b. Dirty condenser or filter. Clean properly. c. Evaporator coil iced. Needs to defrost. See instructions for setting a manual defrost cycle on page 13. d. Shortage of refrigerant, call service.
3. Food compartment is too warm.	<ul style="list-style-type: none"> a. Check door(s) and gasket(s) for proper seal b. Perhaps a large quantity of warm food has recently been added or the door was kept open for a long period of time, in both cases, allow adequate time for the cabinet to recover its normal operating temperature. c. Control setting too high, readjust per instructions on page 9. d. Check that condensing coil is clean.
4. Food compartment is too cold.	<ul style="list-style-type: none"> a. Perhaps a large quantity of very cold or frozen food has recently been added. Allow adequate time for the cabinet to recover its normal operating temperature. b. Adjust the control to a warmer setting, see page 10.
5. Condensation on the exterior surface.	<ul style="list-style-type: none"> a. Check door alignment and gaskets for proper seal. b. Condensation on the exterior surface of the unit is perfectly normal during periods of high humidity.
6. Compressor hums but does not start.	<ul style="list-style-type: none"> a. Call for service.
7. No Power To Unit	<ul style="list-style-type: none"> a. Check if cord & plug has been disconnected. b. Check power supply breaker. c. Check ON/OFF switch.

X. WARRANTY INFORMATION

STANDARD DOMESTIC WARRANTY

TRAULSEN warrants new equipment to the original purchaser, when installed within the United States against defective material and workmanship for one (1) year from the date of original installation. Under this warranty, TRAUlsen will repair or replace, at its option, including service and labor, all parts found to be defective and subject to this warranty. The compressor part is warranted for an additional four (4) years. During this period TRAUlsen will supply replacement compressor(s) if deemed defective; however, all installation, recharging, and repair costs will remain the responsibility of the owner.

This warranty does not apply to units altered from the original equipment design or to damage resulting from fire, water, burglary, accident, abuse, misuse, transit, acts of God, terrorism, attempted repairs, improper installation by unauthorized persons, and does not apply to food loss

THERE ARE NO ORAL, STATUTORY OR IMPLIED WARRANTIES APPLICABLE TO TRAUlsen, INCLUDING BUT NOT LIMITED TO, ANY IMPLIED WARRANTY OF MERCHANTABILITY OR FITNESS FOR ANY PARTICULAR PURPOSE WHICH EXTEND BEYOND THE DESCRIPTION ON THE FACE HEREOF. TRAUlsen SHALL HAVE NO OBLIGATION OR LIABILITY FOR CONSEQUENTIAL OR SPECIAL DAMAGES, GROWING OUT OF OR WITH RESPECT TO THE EQUIPMENT OR ITS SALE, OPERATION OR USE, AND TRAUlsen NEITHER ASSUMES NOR AUTHORIZES ANYONE ELSE TO ASSUME FOR IT ANY OBLIGATION OR LIABILITY IN CONNECTION WITH THE EQUIPMENT OR ITS SALE, OPERATION OR USE OTHER THAN AS STATED HEREIN.

G-SERIES MICROPROCESSOR CONTROL WARRANTY

TRAULSEN warrants to the original purchaser of the G-Series Microprocessor control when installed as part of the Refrigeration Equipment manufactured and sold by TRAUlsen, to be free of defects in material and workmanship under normal service and use for a period of one (1) year from the date of installation, not to exceed fifteen (15) months from the original date of shipment. Under this warranty statement, TRAUlsen will repair or exchange at TRAUlsen'S discretion, F.O.B. factory, any part of said control, which proves to be defective. Inspection by the TRAUlsen Service Department of parts claimed defective shall be final in determining warranty status. The warranty is to include repair or exchange of any defective In-Warranty control or part(s) of said control for:

Part(s) - Any TRAUlsen G-Series Microprocessor Control supplied part(s) found to be defective.

Labor - The labor charges from a TRAUlsen Certified Service Agent to effect the repair or exchange of the defective part(s).

"Defective Part Return" - All claimed defective part(s) must be returned to TRAUlsen for defect validation within 30 days from the date of the repair. Failure to return all claimed defective part(s) to TRAUlsen will invalidate the warranty claim, this warranty statement, and forfeit payment for those repairs effected.

This warranty does not apply to units altered from the original equipment design or to damage resulting from fire, water, burglary, accident, abuse, misuse, transit, acts of God, terrorism, attempted repairs, improper installation by unauthorized persons, and does not apply to food loss, and will not apply if said equipment is located outside The United States.

INTERNATIONAL COMMERCIAL WARRANTY

(for Canadian warranties see domestic US warranty)

TRAULSEN warrants to the original purchaser the Refrigeration Equipment manufactured and sold by it to be free from defects in material and workmanship under normal use and service for a period of one (1) year from date of shipment. Under this warranty, TRAUlsen will reimburse the purchaser for the replacement of any part of said equipment (excluding dryers & refrigerant gas) which then proves to be defective. This warranty does not apply to units altered from the original equipment design or to damage resulting from fire, water, burglary, accident, abuse, misuse, transit, acts of God, terrorism, attempted repairs, improper installation by unauthorized persons, and does not apply to food loss.

TRAULSEN'S standard warranty does not apply to Export Sales. Rather, for a period of one (1) year from date of original installation not to exceed Fifteen (15) months from date of shipment from factory, TRAUlsen:

will replace, F.O.B. factory, any defective parts normally subject to warranty.

will not cover the cost of packing, freight or labor such costs being the sole responsibility of the dealer.

THIS WARRANTY IS IN LIEU OF ALL OTHER WARRANTIES EITHER EXPRESSED OR IMPLIED AND CONSTITUTES TRAUlsen'S FULL OBLIGATION AND LIABILITY.

X. NOTES

XI. INDEX

A			M		
Automatic Condensate Evaporator	3		Manual Defrost Cycle, Starting	13	
			Microprocessor Control, Features	6-7	
B			N		
Battery Back-Up	6				
C			O		
Casters	2		Off-Cycle Defrost	13	
Cleaning, The Condenser	5		ON/OFF Switch	4	
Cleaning, The Exterior	6				
Cleaning, The Interior	6		P		
Clock, Setting The 24-Hour	11		Packaging	2	
Condensate Evaporator	3		Parts Assembly	7	
Control Panel	7		Parts, Spare & Replacement	17-18	
Cord & Plug	3		Power Supply	4	
Compressor Hold Down Provisions	3				
Clearance	4		R		
Customer Access Code	8		Return Authorization	2	
Customer Service Parameters	9		Room Temperature Offset	15	
D			S		
Date, Setting The	12		Self-Closing Door Feature	2	
Daylight Savings Time, Setting	12		Sensor Temperatures, Viewing	15	
Defrost	4		Serial Tag	1	
Defrost Icon	13		Shelf Pins	3-4, 6	
Defrost Lockouts, Setting	14		Shelves	3-4, 6	
			Stay Open Door Feature	2	
E			T		
Evaporator Coil Sensor	9, 15		Temperature Scale, Changing The	10	
			Thermostat Set Point High	9	
F			Thermostat Set Point Low	10	
Freight Damage	2		Tray Slides	4	
			Trouble Shooting	16	
G			U		
Gaskets, Replacing The	5				
			V		
H			Vinyl, Protective Covering	2	
Hinge, Replacement	5				
			W		
I			Warranty	20	
Internal Time Clock	6, 11		Warranty Registration	6	
			Water Resistant Housing	7	
J			Wiring Diagram	3	
K			X		
L			Y		
Legs	2				
Light Switch	5		Z		
Location, Selecting Proper	2				
Louver Assembly	5				

HOURS OF OPERATION:

Monday thru Friday 7:30 am - 4:30 pm CST



Quality Refrigeration

Traulsen

4401 Blue Mound Road Fort Worth, TX 76106
Phone: (800) 825-8220 Fax-Svce: (817) 740-6757
Website: www.traulsen.com