



Quality Refrigeration

INTELA-TRAUL® MASTER SERVICE MANUAL



*For All Full Size Undercounter, G-Series and
R&A Series Refrigerator, Freezer, Dual-Temp
and Hot Food Unit Controllers*

Traulsen

4401 Blue Mound Road - Fort Worth, Texas 76106

Phone: (800) 825-8220 or (817) 625-9671

Fax-Service (817) 740-6757

TABLE OF CONTENTS

I. General Information	
a) How To Use This Manual	Page 2
b) About INTELA-TRAUL	Page 2
c) Operating The Controller	Page 2
II. Basic Service Procedures	
a) Adjusting The Temperature	Page 3
b) Starting A Manual Defrost Cycle (R & A Series)	Page 4
c) Starting A Manual Defrost Cycle (G-Series)	Page 5
III. Troubleshooting	
a) Checking For Defective Sensors	Page 6
b) Checking For Failed Relays	Page 7
c) Checking For Other Failed Components	Page 8
d) Checking For Iced Evaporator Coil	Page 9
e) Proper Sensor Placement	Page 10
IV. Control Architecture	
a) R & A Series Refrigerator & Freezer Vertical Controllers	Page 11-14
b) Undercounter Refrigerator & Freezer Horizontal Controllers	Page 15
c) G-Series Refrigerator & Freezer Vertical Controllers	Page 16-17
d) R & A Series Heated Cabinet Vertical Controllers	Page 18-20
V. Removal/Installation	
a) All Vertical Controllers	Pages 21-22
b) All Horizontal Controllers	Page 23
VI. Problem Diagnosis	
a) How To Use Troubleshooting Trees	Page 24
b) Hi-Temp Alarm (all HT/RI & LT/IF models)	Page 25
c) Lo-Temp Alarm (all HT/RI & LT/IF models)	Page 26
d) Door Open Alarm (all HT/RI, LT/IF HF/IH models)	Page 27
e) Power Loss Alarm (all HT/RI, LT/IF HF/IH models)	Page 28
f) System Leak Alarm (all HT/RI & LT/IF models)	Page 29
g) Condenserclean Alarm (all HT/RI & LT/IF models)	Page 30
VII. Accessing The Engineering Level	Page 31
VIII. Control Parameters	
a) Parameter Descriptions	Page 32-33
b) Parameter Access & Units Of Measurement	Page 34
c) G-Series Parameter Settings	Page 35
d) R-Series Parameter Settings - Refrigerator Models	Page 36
e) R-Series Parameter Settings - Freezer Models	Page 37
f) Undercounter Parameter Settings	Page 38

I. GENERAL INFORMATION

I. a - HOW TO USE THIS MANUAL:

Traulsen provides this manual as an aid to the service technician in installation, operation, and maintenance of INTELA-TRAUL® Controllers. When used properly, this service manual can help the service technician maintain, troubleshoot and diagnose most of the problems and malfunctions that may occur with the Controllers.

This manual covers the four different types of Controllers (**Full Size Undercounter, G-Series, R&A Series Refrigerator & Freezer, and R&A Series Hot Food**). These vary slightly from one another, all exceptions are noted, and where appropriate separate sections are provided.

While we believe that most aspects of the controllers are covered in this manual, should you encounter a condition not addressed, or require a wiring diagram please contact:

Traulsen
4401 Blue Mound Road Fort Worth, TX 76106
Attn: Service Department
Phone: (800) 825-8220 or (817) 625-9671
Fax: (817) 740-6757

All service communication must include:

- Model Number & Serial Number Of Unit
- A detailed explanation of the problem

I. b - ABOUT INTELA-TRAUL:

The Traulsen INTELA-TRAUL and G-Series microprocessor controls are microprocessor based systems which replace several electromechanical components typically built into refrigeration products, such as: time clocks, thermometers, defrost limit switches and temperature controls, all combined into one solid state modular unit.

These microprocessor controls both monitor a cabinet air sensor and a coil sensor. The INTELA-TRAUL on the R & A Series also includes a discharge line sensor and a relative humidity sensor (H1 versions only). In conjunction with the programmed parameters of the control, and the information received, it cycles the refrigeration system ON and OFF at set temperatures, initiates and/or terminates defrost cycles, and initiates one of several alarm features if a problem is sensed (R & A Series only). R & A Series controls also allow the operator to cycle the door perimeter heaters ON/OFF as needed.

















I. c - OPERATING THE CONTROLLER:

When operating the controller it is important to note that you only have approximately 20-30 seconds between button pushes. If you take longer than 30 seconds, the controller will revert back to displaying the cabinet temperature. If you enter the wrong security code, the controller will revert back to displaying the cabinet temperature. You can exit the parameters at any time by waiting 20-30 seconds for the control to return to normal operation.









II. BASIC SERVICE PROCEDURES

II. a - ADJUSTING THE TEMPERATURE:



The Display
Will Read

- Step 1: Press . Display will read "CUS." 
- Step 2: Press . Display will read "000" with the left digit flashing. 
- Step 3: Press . Display will read "000" with the center digit flashing. 
- Step 4: Press  until the center digit changes to an "A". 
- Step 5: Press . Display will read "0A0" with the right digit flashing. 
- Step 6: Press  until the right digit changes to a "1". 
- Step 7: Press . Display will read "SPH". 
- Step 8: Press  again.
- Step 9: Press  or  to adjust temperature to desired setting.

(NOTE: SPH should be set at 38 to 40°F for refrigerators and 0°F for freezers)

- Step 10: When display reads the desired temperature press . 
- Step 11: Press  until display reads "SPL". 
- Step 12: Press .
- Step 13: Press  or  to adjust temperature to desired setting. 

(NOTE: SPL should be set at 34°F for refrigerators and -4°F for freezers)

- Step 14: Press .
- Step 15: Press  to exit (R & A Series only). On G-Series models the controller will automatically revert back to normal temperature display operation after a delay of approximately 20-30 seconds.

II. BASIC SERVICE PROCEDURES

II. b - STARTING A MANUAL DEFROST CYCLE (R & A Series):

The Display
Will Read

Step 1: Press . Display will read "CUS."



Step 2: Press . Display will read "000" with the left digit flashing.



Step 3: Press . Display will read "000" with the center digit flashing.



Step 4: Press  until the center digit changes to an "A".



Step 5: Press . Display will read "0A0" with the right digit flashing.



Step 6: Press  until the right digit changes to a "1".



Step 7: Press . Display will read "SPH".



Step 8: Press  until the control reads "Sd," Start Manual Defrost.



Step 9: Press . Display will read "n" (NO).



Step 10: Press  or . Display will read "4" (YES).



Step 11: Press . Controller will display "SPH" for 30 seconds and



then "DEF" will appear.

NOTE: The controller will automatically revert back to normal operation after a delay of approximately 20-30 seconds.



























NOTE:

Traulsen R & A Series refrigerator models also include an off-cycle defrost feature, which occurs once an hour. This is indicated by the control display, is time or temperature terminated, and generally is of 3 - 10 minutes in duration.

II. BASIC SERVICE PROCEDURES

II. c - STARTING A MANUAL DEFROST CYCLE (G-Series):

- | | The Display Will Read |
|--|---|
| Step 1: Press  . Display will read "CUS." |  |
| Step 2: Press  . Display will read "000" with the left digit flashing. |  |
| Step 3: Press  . Display will read "000" with the center digit flashing. |  |
| Step 4: Press  until the center digit changes to an "A". |  |
| Step 5: Press  . Display will read "0A0" with the right digit flashing. |  |
| Step 6: Press  until the right digit changes to an "1". |  |
| Step 7: Press  . Display will read "SPH". |  |
| Step 8: Press  until the control reads "Sd," Start Manual Defrost. |  |
| Step 9: Press  . Display will read "n" (NO). |  |
| Step 10: Press  or  . Display will read "4" (YES). |  |
| Step 11: Press  . Display will then read "SPH," Start Manual Defrost. |  |
| Step 14: Press  or  to scroll to the next parameter, otherwise the controller will automatically revert back to normal operation after a delay of approximately 20-30 seconds. | |



NOTE:

Traulsen G-Series refrigerator models also include an off-cycle defrost feature, which occurs once an hour. This is indicated by the control display, is time terminated, and is generally of 3 - 10 minutes in duration.

The defrost cycle on Traulsen G-Series freezer models can be either time or temperature terminated.

DEFROST ICON

III. TROUBLESHOOTING

III. a - CHECKING FOR DEFECTIVE SENSORS:

The Display
Will Read

Step 1: Press . Display will read "CUS."



Step 2: Press . Display will read "000" with the left digit flashing.



Step 3: Press . Display will read "000" with the center digit flashing.



Step 4: Press  until the center digit changes to an "A".



Step 5: Press . Display will read "0A0" with the right digit flashing.



Step 6: Press  until the right digit changes to an "1".





Step 7: Press .

Step 8: Press  until display reads "EL". Press .



If the display now reads "-40," check for loose connection on the EVAPORATOR sensor. If the display has a very high reading such as "266," replace the evaporator sensor.



NOTE: Erroneous readings may be the result of a faulty sensing circuit (open or shorted) in the Controller.

Step 9: Press  until the display reads "DL¹". Press .



In the event that the display now reads "-40," check for a loose connection on the DISCHARGE LINE sensor. If the display has a reading of "220" or higher, check for lack of adequate air-flow through the condenser, a bad condenser motor, or any other condition around the unit which could cause a high temperature, such as a steam table or a crossdraft. Otherwise, proceed with replacing the DISCHARGE LINE sensor.

NOTE: Erroneous readings may be the result of a faulty sensing circuit (open or shorted) in the Controller.

Step 10: Press  until the display reads "AA²". Press .



Display should read the approximate ambient air temperature behind the louver panel. If the display reads "111" check for a loose connection on the RH/AMBIENT AIR sensor. If the display reads "32.0" check the sensor for a short circuit.

NOTE: If display reads -40 or 266 the cabinet sensor is defective and requires replacement.

NOTE: Ambient Air Sensor not included on MIT version controllers.

NOTE: Erroneous readings may be the result of a faulty sensing circuit (open or shorted) in the Controller (on H1 control version only).

1= DL is not included on G-Series controllers.

2= AA is not available with MIT version controllers.

III. TROUBLESHOOTING

III. b - CHECKING FOR FAILED RELAYS:

Checking For A Failed Internal Controller Relay:

1. Gain access to Controller compressor relay (see REMOVAL INSTRUCTIONS within this service manual for the specific type of controller your are servicing).
2. Locate the connector with the black/blue/purple wires and unplug it. Refer to the schematic on the side of the controller, or refer to the appropriate wiring diagram (to obtain this please contact the factory, referencing the serial number of the unit involved).
3. Using a volt/ohm meter (VOM) with the power OFF, check the resistance across the black to blue wires of the Controller connector. If completed circuit is indicated (with no power to the Controller), the contacts are stuck closed and the Controller should be replaced (on MIT versions either the relay box or one of the other relays within the unit need to be replaced).

Checking For A Failed External "Slave" Relay or Solid State Relay (SSR), p/n 337-60360-01 (MIT II Only):

1. Gain access to the controller compressor relay (see REMOVAL INSTRUCTIONS within this service manual for the specific type of controller your are servicing).
2. Locate the external "slave" relay and unplug the harness connectors.
3. Using a volt/ohm meter (VOM), check the resistance from the "COM" terminal to the "NO" terminal. If a completed circuit is indicated, the contacts are stuck closed and the slave relay should be replaced.
4. For the SSR, remove the black and blue wires from terminals 3 & 4. Using a volt/ohm meter, and with the power OFF, measure the resistance across the terminals. A completed circuit indicates that the circuit is closed and that the relay should be replaced. A reading of 25 m Ω to 35 m Ω is considered normal for an open circuit in the SSR.

Checking For A Failed Door/Light Relay (R & A Series models only):

1. Gain access to Controller door relay (see REMOVAL INSTRUCTIONS within this service manual for the specific type of controller your are servicing).
2. Remove the wire from the door relay coil.
3. Using a volt/ohm meter (VOM), check across the relay contacts. If an open across the contacts is not indicated, replace the door relay.

NOTE: Equipment manufactured with the MIT II controller version do not include a Door/Light relay).

4. Physically check the switch for evidence of water. If switch has water in it, proceed with replacing the switch.

III. TROUBLESHOOTING

III. c - CHECKING FOR OTHER FAILED COMPONENTS:

Checking For A Failed Door Switch:

1. Remove the door(s) from the unit involved.
2. Locate the door switch, which is located behind the top door hinge(s).
3. Remove the switch from the cabinet.
4. Using a volt/ohm meter (VOM), check across the switch contacts. "COM" to "NO" should read open. If not, replace the switch.
5. Reinstall the switch and hinge onto the cabinet.

NOTE: If the unit has more than one door, check ALL door switches in the same manner as described in steps 1 thru 5 above.

Checking For A Failed Controller Transformer (H1 & MIT I control versions only):

1. Check incoming voltage. Voltage at the unit must be within the ranges shown in the table below.

VOLTAGE		
MIN	MAX	STANDARD
104 VAC	126 VAC	115/60/1
187 VAC	253 VAC	208-230/60/1
10.2 Volts (MIT 12.4)	13.8 Volts (MIT 14.7)	Transformer Output Voltage

2. If the controller display does not come back on, use a volt/ohm meter (VOM) and check the output voltage of the controller transformer.
3. If the output voltage from the transformer is not within the range shown in the table above, replace the transformer. If the transformer tests OK, replace the controller instead.
4. For equipment manufactured with the MIT II controller version the transformer is mounted inside the relay module. Check between 17 and 8 on 18 pin connector on relay module for 12V DC.

Checking Cabinet, Coil or Discharge Line Sensors:

1. Gain access to CABINET, COIL or DISCHARGE LINE sensor and disconnect it.
2. Place tip of sensor probe in a mixture of icewater for several minutes. Allow enough time for sensor probe to acclimate to the icewater.
3. At 32°F, probe resistance should be 32.7K Ohms, +/- 10%. If resistance is not within this range, replace the sensor.

III. TROUBLESHOOTING

III. d - CHECKING FOR ICED EVAPORATOR COIL:

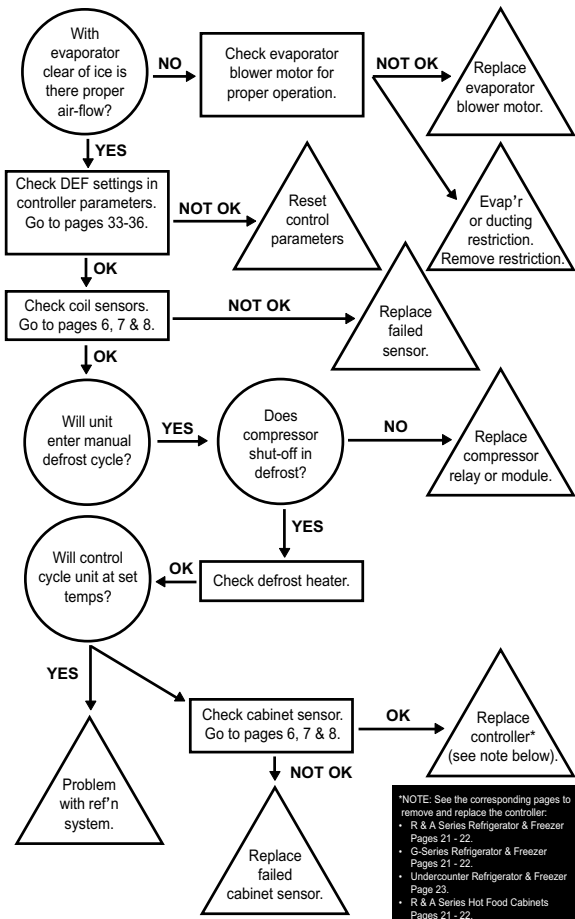

III. TROUBLESHOOTING

III. e - PROPER SENSOR PLACEMENT:

Coil Sensor:

The coil sensor should be inserted into the return air side of the evaporator coil. On freezer models only this sensor should be centered approximately 2" (two inches) from the top (horizontally through coil - centered in coil).

On refrigerator models this sensor should be mounted on top of the coil.

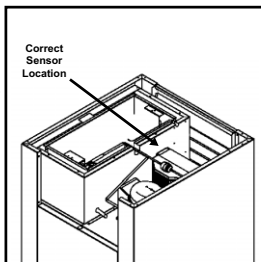

Cabinet Air Sensor:

The cabinet air sensor should be mounted inside the evaporator housing (hump) on the return air side of the evaporator coil.

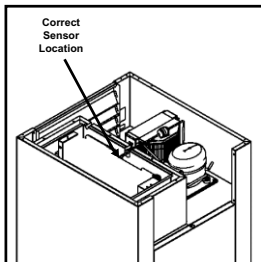

Discharge Sensor (R & A Series Only):

The discharge air sensor should be mounted on the hot gas side of the compressor. Placement should be as close to the compressor as possible and must be placed prior to the beginning of the hot gas loop. Please note that discharge sensors must be insulated.

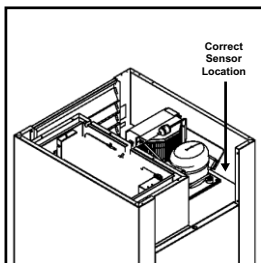

IV. CONTROL ARCHITECTURE

IV. a - R & A SERIES REFRIGERATOR & FREEZER VERTICAL CONTROLLER:

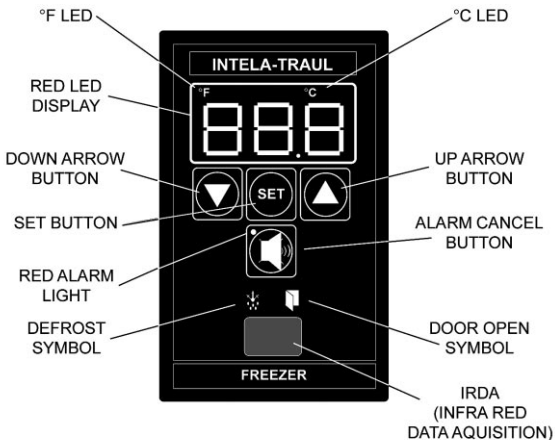

NOTES: IRDA not included on equipment manufactured with the MIT II control version.

See parts assembly on pages 12-13.

IV. CONTROL ARCHITECTURE

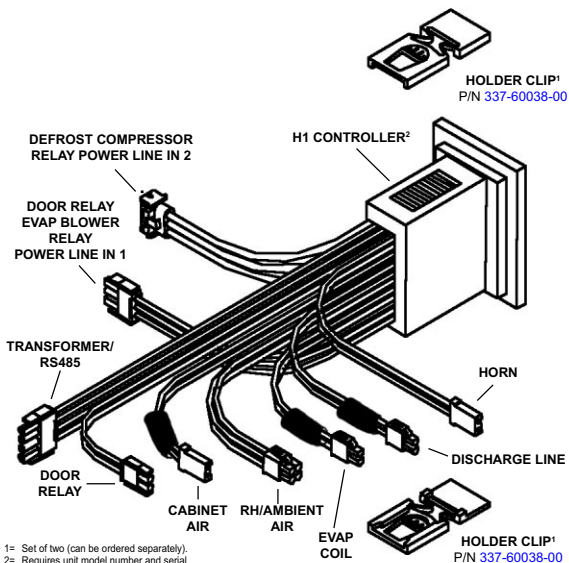

COIL SENSOR³
P/N 337-60071-02



DISCHARGE SENSOR³
P/N 337-60072-00



CABINET SENSOR³
P/N 337-60069-02



HORN³
P/N 337-60070-00



RH SENSOR³
P/N 337-60080-00
(control versions H only)

3= Component can be ordered separately.

IV. CONTROL ARCHITECTURE

IV. b - R & A SERIES REFRIGERATOR & FREEZER VERTICAL CONTROLLER: Parts assembly for H1 thru MIT control versions only

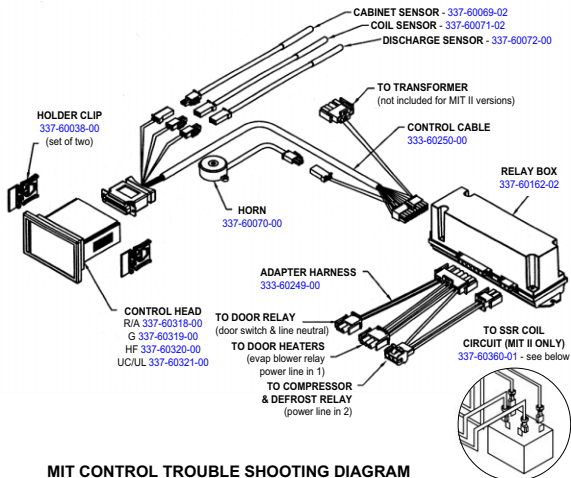

MIT CONTROL TROUBLE SHOOTING DIAGRAM

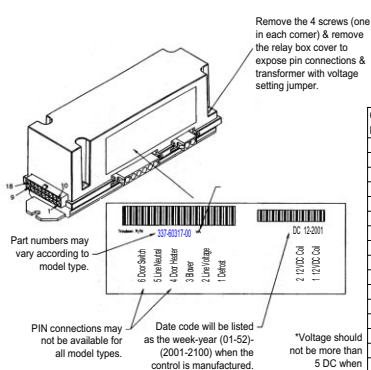

NOTE

All pins in this connection should not read more than 20 VAC



Connector Pin No.	Color	Signal
1	Gray	Blower*
2	Orange	Door Heater*
3	Green	Alarm From Controller
4		
5		
6	Brown	
7	White/Purple	-RS485
8	Black	Ground
9	Yellow/Red	12 VAC
10	Blue	Compressor*
11	Purple	Defrost*
12	Yellow	Door Open Signal
13	Red	Power to Horn
14	Orange	
15	White	
16	Pink	+RS485
17	Red	12 VDC to Controller
18		

IV. CONTROL ARCHITECTURE

IV. c - UC & UL (UNDERCOUNTER) HORIZONTAL CONTROLLER:

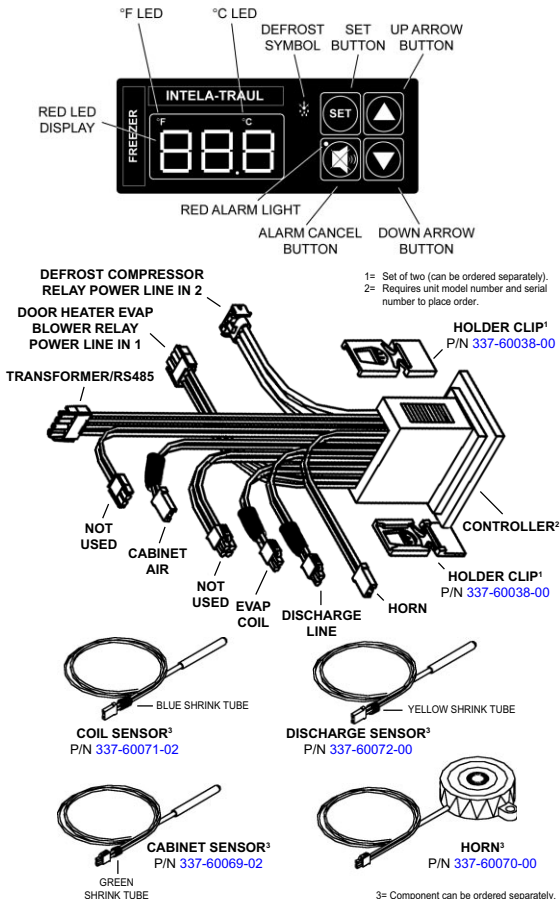

IV. CONTROL ARCHITECTURE

IV. c - UC & UL (UNDERCOUNTER) HORIZONTAL CONTROLLER:

Parts assembly for MIT control version only

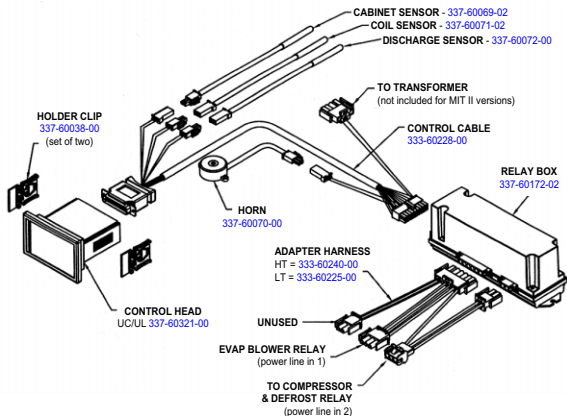

MIT CONTROL TROUBLE SHOOTING DIAGRAM

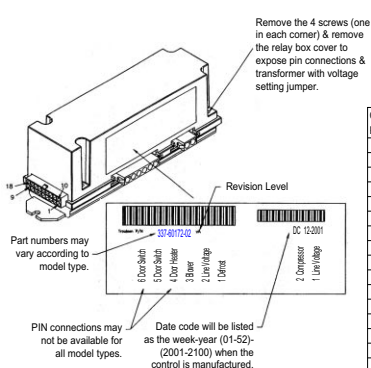

NOTE

All pins in this connection should not read more than 20 VAC



Connector Pin No.	Color	Signal
1	Gray	Blower*
2	Orange	Door Heater*
3	Green	Alarm From Controller
4	Black	Return From Horn
5		
6		
7	White/Purple	-RS485
8	Black	Ground
9	White	12 VAC
10	Blue	Compressor*
11	Purple	Defrost*
12	Yellow	Door Open Signal
13	Red	Power to Horn
14		
15		
16	Pink	+RS485
17	Red	12 VDC to Controller
18	Black	12 VAC

*Voltage should not be more than 5 DC when measured to ground (pin 8).

IV. CONTROL ARCHITECTURE

IV. d - G-SERIES REFRIGERATOR & FREEZER VERTICAL CONTROLLER:

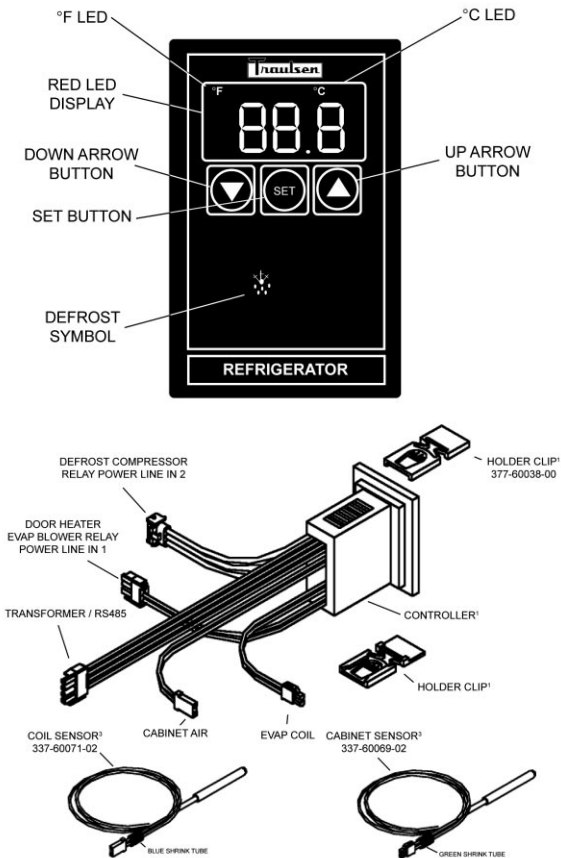

IV. CONTROL ARCHITECTURE

IV. d - G-SERIES REFRIGERATOR & FREEZER VERTICAL CONTROLLER:

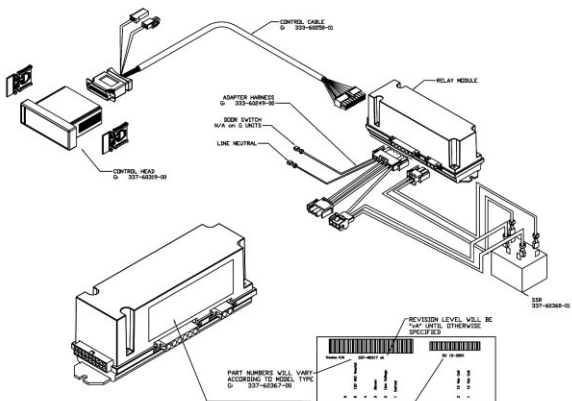

CONNECTOR PIN NUMBER	COLOR	SIGNAL
1		
2	GRAY	BURGER
3		
4		
5		
6		
7		
8	BLACK	GROUND
9	YELLOW/RED	POWER LINE FAILURE
10	BLUE	COMPRESSOR
11	PURPLE	DEFROST
12		
13	ORANGE	3 VDC FROM CONTROLLER
14		
15		
16	RED	12 VDC TO CONTROLLER

IV. CONTROL ARCHITECTURE

IV. e - R-SERIES HEATED CABINET VERTICAL CONTROLLER:

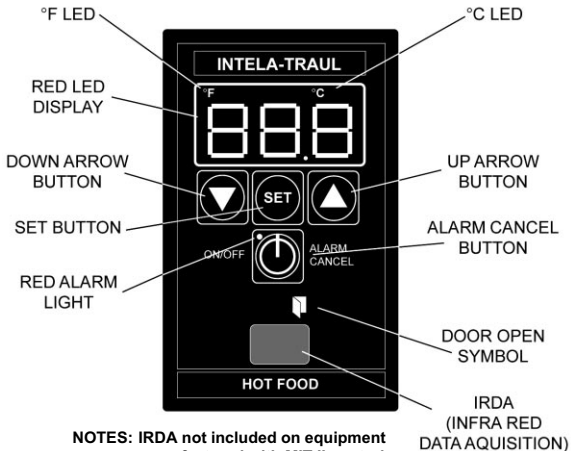

NOTES: IRDA not included on equipment manufactured with MIT II control version.

See parts assembly on pages 17-18.

HOT FOOD CABINET START-UP (pre-MIT version):

When power is first applied to the unit, you must set the temperature by pressing the "SET" and "UP ARROW" buttons at the same time using equal pressure with both thumbs, until the temperature appears on the display. Next, use the "UP" button to reach the desired temperature (maximum 180°), then press and release the "SET" button to lock it in.

After this is done you can turn the control ON and OFF by pressing and releasing the "ALARM CANCEL" button.

Be aware to watch for the display constantly reading "OFF". This is an indication of a possible faulty cabinet sensor. To remedy, replace the sensor and reset the operating temperature.

HOT FOOD CABINET START-UP (MIT version):

The MIT control offers an additional means of turning the cabinet heaters ON and OFF. After the operating temperature has been set, the operator can continuously turn the unit OFF and then back ON again to the same operating temperature by pressing the "ON/OFF" button on the face of the control.

Please note that this feature will not function if the control is in an alarm state with the alarm LED illuminated.

IV. CONTROL ARCHITECTURE

IV. e - R-SERIES HEATED CABINET VERTICAL CONTROLLER:

Parts assembly for H1 control versions only

1= Set of two (can be ordered separately).

2= Requires unit model number and serial number to place order.

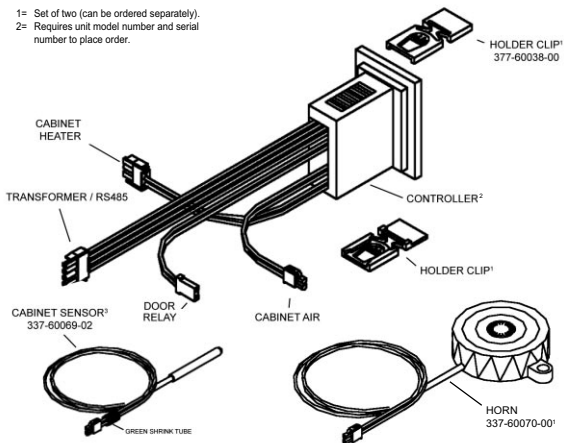

IV. CONTROL ARCHITECTURE

IV. e - R-SERIES HEATED CABINET VERTICAL CONTROLLER: Parts assembly for MIT control versions only

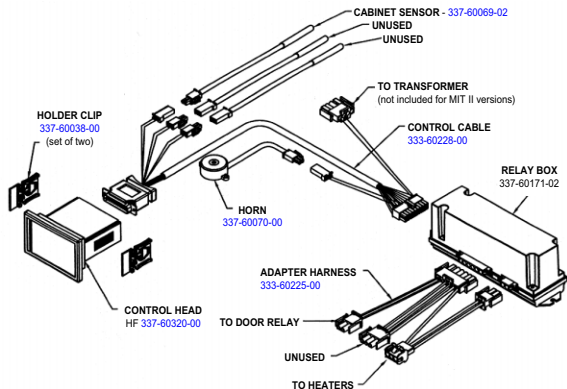

MIT CONTROL TROUBLE SHOOTING DIAGRAM

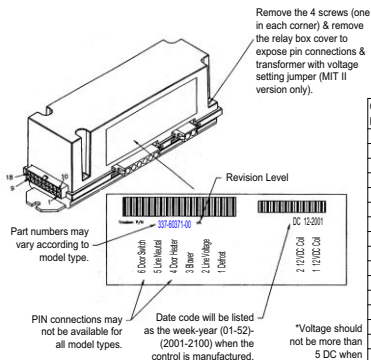

NOTE

All pins in this connection should not read more than 20 VAC



Connector Pin No.	Color	Signal
1	Gray	Blower*
2	Orange	Door Heater*
3	Green	Alarm From Controller
4	Black	Return To Horn
5		
6		
7	White/Purple	-RS485
8	Black	Ground
9	White	12 VAC
10	Blue	Compressor*
11	Purple	Defrost*
12	Yellow	Door Open Signal
13	Red	Power to Horn
14		
15		
16	Pink	+RS485
17	Red	12 VDC to Controller
18	Black	12VAC

*Voltage should not be more than 5 DC when measured to ground (pin 8).

V. REMOVAL/INSTALLATION

V. a - ALL VERTICAL CONTROLLERS:

To remove INTELA-TRAUL® (p/n's 337-60090-00, 337-60091-00 and 337-60092-00) and G-Series (p/n's 337-60093-00, 337-60094-00 and 337-60095-00) Vertical Controller from the unit in which it is installed, proceed as follows (If unable to access the unit from the rear perform steps 1 through 3, otherwise, proceed to step 4):

(2) SLOT HEAD THUMBSCREWS

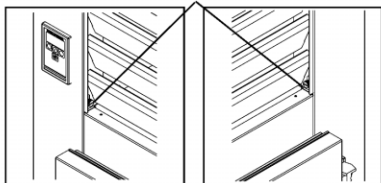

1. At front of unit, remove two (2) slot head thumb screws from bottom corners of louver assembly. Set thumbscrews aside.

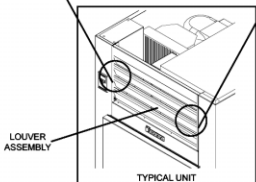

(2) SLOT HEAD THUMBSCREWS

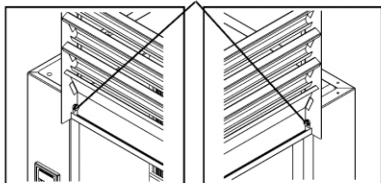

2. Swing louver assembly up and away from front of unit until it stops.
3. Remove two (2) Slot head thumbscrews from top of louver assembly. Set thumbscrews and louver assembly aside.

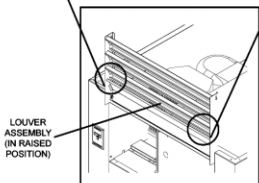

V. REMOVAL/INSTALLATION

WARNING: DISCONNECT ALL POWER BEFORE PROCEEDING

- At the top of the junction box, remove three (3) Phillips head screws. Set screws aside.
- Locate one (1) Phillips head screw at bottom of junction box, and remove. Set screw aside.

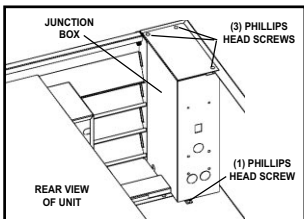

- Carefully slide junction box away from front of unit until all wiring and connections to the controller are exposed.
- Locate all nine (9) Controller connections (five for G-Series), then carefully disconnect each one.

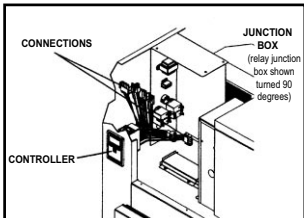

- Firmly grasp and compress the rounded portion of the middle prong on each holder clip. Slowly slide each holder clip off the controller. Set clips aside.

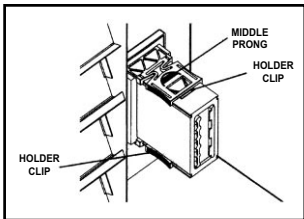

NOTE:

Be sure ALL components have been disconnected from the Controller before performing the next step.

- Slowly pull Controller through mounting hole and set aside.

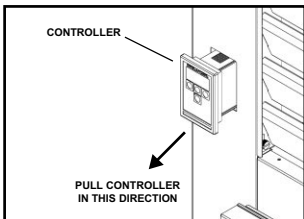

TO RE-INSTALL CONTROLLER, REVERSE THE PRECEEDING PROCEDURE.

V. REMOVAL/INSTALLATION

V. a - ALL HORIZONTAL CONTROLLERS:

To remove INTELA-TRAUL® (p/n's 337-60096-00 and 337-60097-00) Horizontal Controller from the unit in which it is installed, proceed as follows:

WARNING: DISCONNECT ALL POWER BEFORE PROCEEDING

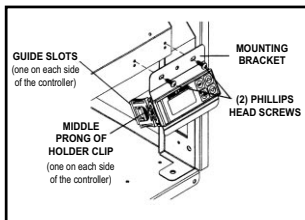
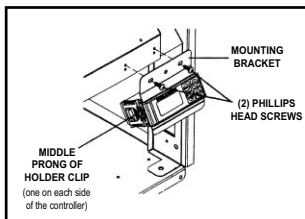
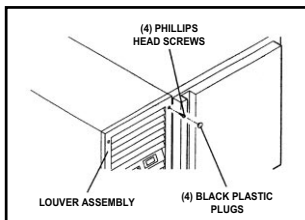

1. Check to make sure that the power cable is disconnected from the wall.
2. Remove the four (4) black plugs that are located in each corner of the power pack louver assembly. Set plugs aside.
3. Remove the four (4) Phillips head screws holding the louver assembly in place. Set screws and louver assembly aside.
4. Remove the two (2) Phillips head screws that hold the Controller and the bracket assembly to the condenser fan assembly. Set screws aside.
5. Locate all nine (9) Controller connections, then carefully disconnect each one.
6. Firmly grasp and compress the rounded portion of the middle prong on each holder clip. Slowly slide each holder clip off the Controller. Set clips aside.

TO RE-INSTALL CONTROLLER, REVERSE THE PRECEDING PROCEDURE.

VI. PROBLEM DIAGNOSIS

VI. a - HOW TO USE THE TROUBLESHOOTING TREES:

The troubleshooting trees on the following pages were developed as an aid to the service technician in determining the exact solution to a certain problem or malfunction. When used as designed, the troubleshooting trees can lead you from a general symptom to the most likely component to suspect as the cause of the problem.

The trees are made up of three different types of boxes:

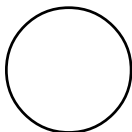

QUESTION



CHECK

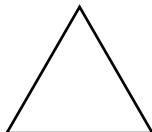

SOLUTION

QUESTION

Boxes ask a yes/no question and the answer will lead to either another question box, a check box, or a solution box.

CHECK

Boxes will suggest a point to check for proper operation, and will often refer you to a page in either the SERVICE INFORMATION or the REMOVAL/INSTALLATION sections of this manual. The result of the check may lead to another box, or a solution box.

SOLUTION

Boxes suggest the most likely component to cause the malfunction described in the heading of the tree. When reaching a solution box, do not immediately assume the component is defective. The final step is to use the SERVICE INFORMATION section of this manual to verify that the component is defective.

To use the troubleshooting trees, first find the page with the heading describing the type of problem occurring. Begin at the top of the page and follow the tree, step-by-step. When a check box is reached, refer to the suggested section to make the check suggested. Once a solution box is reached, refer to the suggested section to verify that the component in the solution box is indeed defective, and repair or replace per the direction in that section.

VI. b- HIGH TEMPERATURE ALARM

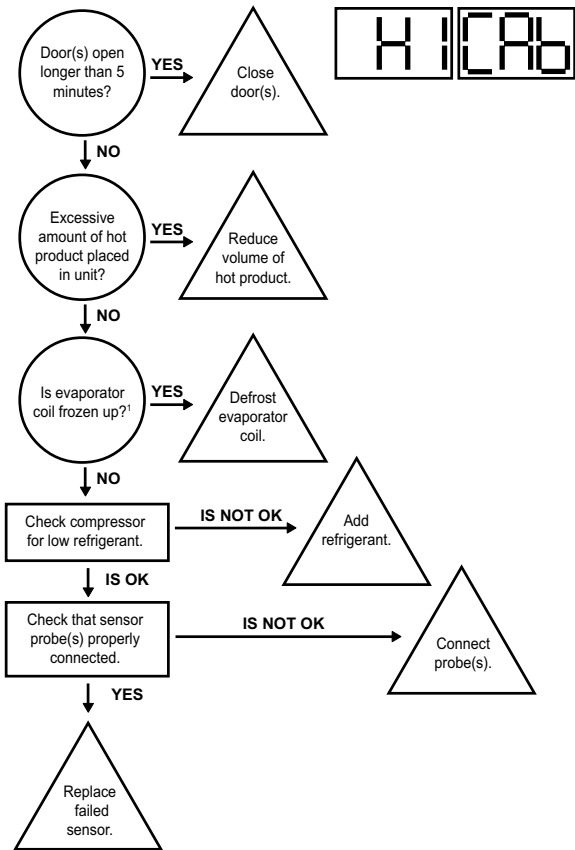

¹= See procedure on page 9.

VI. c- LOW TEMPERATURE ALARM

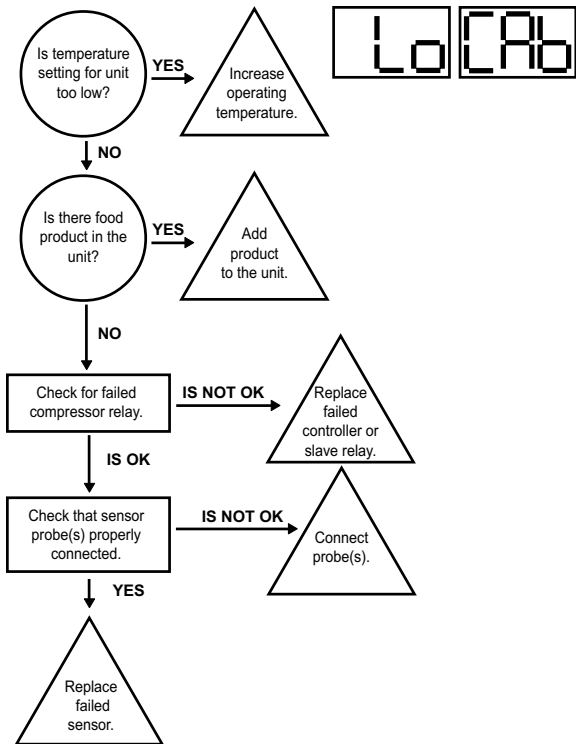

NOTE ON HOT FOOD UNITS ONLY

Hot food units are designed to hold hot food at set temperature. The cabinet is not designed to heat cold products.

VI. d- DOOR OPEN ALARM

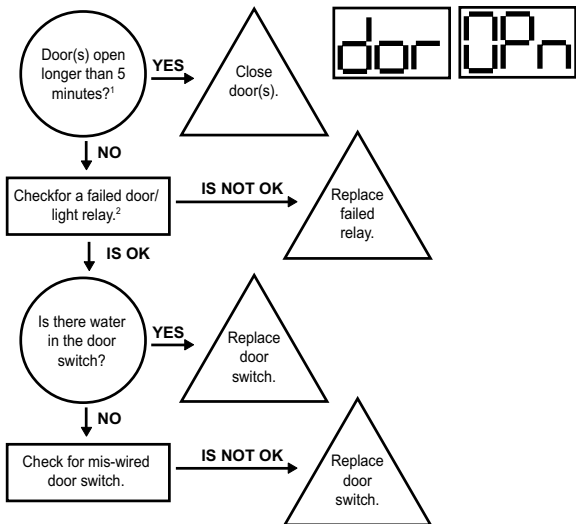

1= H1 and MIT 1 control versions only.

2= See procedure on page 7.

VI. e- POWER LOSS ALARM

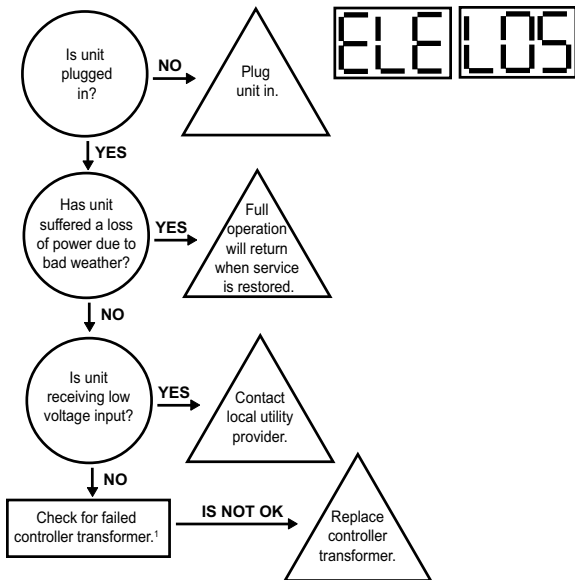

1= See procedure on page 8.

VI. f- SYSTEM LEAK ALARM

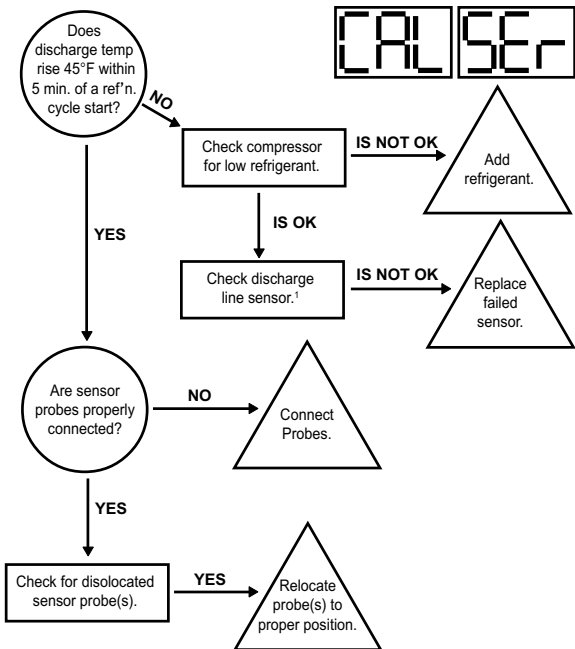

¹= See procedure on page 8.



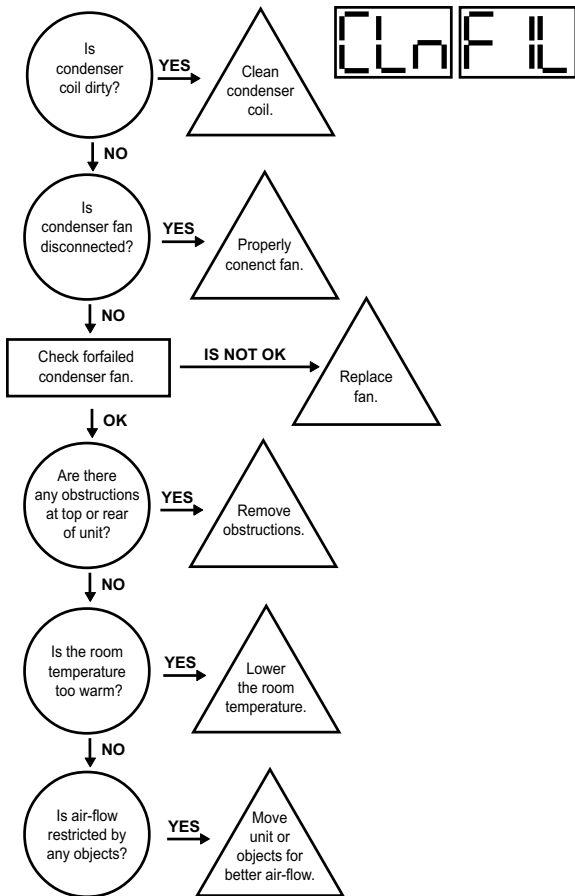

















VI. g - CONDENSERCLEAN ALARM



VII. ACCESSING THE ENGINEERING LEVEL

VII. a - ACCESSING THE ENGINEERING LEVEL:

Not all control parameters can be adjusted at the customers level of access. To adjust these other parameters it is first necessary to gain access to the ENGINEERING LEVEL. Please follow the below procedure in order to enter this level.

	The Display Will Read
Step 1: Press  . Display will read "CUS."	
Step 2: Press  until "EnG" is displayed.	
Step 3: Press  . Display will read "000" with the left digit flashing.	
Step 4: Press  until the left digit changes to an "9".	
Step 5: Press  . Display will read "900" with the center digit flashing.	
Step 6: Press  until the center digit changes to an "9".	
Step 7: Press  . Display will read "990" with the right digit flashing.	
Step 8: Press  until the right digit changes to an "E".	
Step 9: The display will read (99E), press  .	
Step 10: Press  . The display will now read "FOC" - See Note.	

NOTE: R & A Series Only, for G-Series models press  for the control to display "FOC."

VIII. CONTROL PARAMETERS

VIII. a - PARAMETER DESCRIPTIONS:

FOC	3-digit code which identifies the .hex file loaded at the factory.
ADR	Device address for NAFEM networks.
BAU	Communications rate when connected into a NAFEM network.
NAF	Allow the control to communicate with a NAFEM network.
SPH	High value of desired cabinet temperature range.
SPL	Low value of desired cabinet temperature range.
SHL	Lowest temperature of allowed range for setting of SPH.
SHH	Highest temperature of allowed range for setting of SPH.
SLL	Lowest temperature of allowed range for setting of SPL.
SLH	Highest temperature of allowed range for setting of SPL.
RO	Difference, in degrees, between displayed & measured temperature.
HI	The highest temperature the cabinet air temperature is allowed to reach before triggering a High-Temp alarm.
LO	The lowest temperature the cabinet air temperature is allowed to reach before triggering a Low-Temp alarm.
SCL	Sets the temperature display scale (fahrenheit or celsius).
HAD	Time, in minutes, that the controller delays triggering the High-Temp alarm at any start-up or at the end of a defrost cycle.
LAD	Time, in minutes, that the controller delays triggering the Low-Temp alarm if cabinet air temperature equal or below SPL setting.
AC	The amount of time, in minutes, that the compressor must be off between cycles.
DEF	Defines the type of heat used to defrost the coil: Electric, Hot Gas, None or Off-Cycle.
IBD	The amount of time, in hours, between the end of the drip time& start of the next defrost cycle.
DDC	The maximum amount of time, in minutes, that the heat will be on during a defrost cycle.
CDE	The temperature of the evaporator coil that indicates the end of a defrost heat cycle.
DDE	The amount of time, in minutes, between the defrost heat being turned off and the compressor turning on.
BDD	The delay time, in minutes, between the end of the drip time and and before the evaporator blower turns on.
BSD	The temperature of the evaporator coil that triggers the evaporator blower to turn on after drip time ends.
ODD	The maximum amount of time, in minutes, that the display will read the last temperature recorded before entering the defrost cycle.
SD	Allows a technician to start or stop a defrost cycle.
CFA	Allows the customer to turn the clogged filter alarm ON/OFF (R & A Series only).
CCR	The minium amount of time, in minutes, that the compressor must be running before generating a clogged filter alarm.
CDL	The discharge line temperature that will trigger a clogged filter alarm.
DOA	Allows the customer to turn the door open alarm ON/OFF in units equipped with the appropriate hardware.
DAD	The time, in minutes, that a door must be open before triggering a door open alarm.

VIII. CONTROL PARAMETERS

VIII. a - PARAMETER DESCRIPTIONS (continued):

APD	The amount of time, in seconds, that a visual alarm text will be displayed.
ATD	Alarm temperature delay.
AAS	Allows the customer to set the type of audible alarm style, either Blast, OFF or Continuous.
CL	Allows the customer to set the time of day.
DAY	Allows the customer to set the date.
DS	Sets daylight savings time On or OFF.
DL1	Selects the time to start a defrost lockout.
DL2	Selects the time to start a defrost lockout.
DL3	Selects the time to start a defrost lockout.
DL4	Selects the time to start a defrost lockout.
DCF	Allows the customer to set the percentage of time that the door perimeter heaters will operate, to control surface condensation.
CON	The amount of time the compressor will run in the event of a cabinet air sensor failure.
COF	The amount of time, in minutes, that the compressor will be OFF in the event of a cabinet air sensor failure.
EL	Displays the evaporator temperature at the time (press set or the up arrow button to display this feature).
DL	Displays the discharge line temperature at the time (press set or the up arrow button to display this feature).
CB	When activated (by pressing the set or up arrow buttons), will display the cabinet air temperature at the time the button is pressed.
PLn	When activated will display the approximate line voltage.
RCO	Will energize the compressor relay for 10 seconds when activated.
RdF	Will energize the heater relay for 10 seconds when activated.
RFA	Will energize the blower relay for 10 seconds when activated.
RDH	Will energize the door heater relay for 10 seconds when activated.
Pro	Parameter used only when reflashing the program memory.
CEP	When activated, will return all of the parameters to the initial factory settings.
REF	Displays the revision level of the software loaded into memory.

VIII. CONTROL PARAMETERS

VIII. b - PARAMETER ACCESS & UNITS OF MEASUREMENT:

H1, MIT I & MIT II CONTROL VERSIONS ONLY

Control Parameter	Description	Access	Unit of Measure
ADR*	Device Address	ENG	
BAU*	Comm. Baud Rate in K	ENG	KBaud
NAF*	NAFEM Communications Enable	ENG	On/Off
SPH	Temperature Set-Point High	CUS	Degree
SPL	Temperature Set-Point Low	CUS	Degree
SHL	Set-Point High/Low	ENG	Degree
SHH	Set-Point High/High	ENG	Degree
SLL	Set-Point Low/Low	ENG	Degree
SLH	Set-Point Low/High	ENG	Degree
RO	Room Offset	CUS	Degree
HI	Upper Temperature Limit	ENG	Degree
LO	Lower Temperature Limit	ENG	Degree
SCL	Temperature Scale	CUS	F or C
HAD	High-Temperature Alarm Delay	ENG	Minute
LAD	Low-Temperature Alarm Delay	ENG	Minute
AC	Anticycling	ENG	Minute
DEF	Defrost Type	ENG	Electric/Gas/Off
IBD	Intervals Between Defrosts	ENG	Hours
DDC	Maximum Defrost Duration	ENG	Minute
CDE	Coil Temperature At End of Defrost Cycle	ENG	Degree
DDE	Drip Time At End of Defrost Cycle	ENG	Minute
BDD	Blower Delay At Drip Time	ENG	Minute
BSD	BSD After Defrost End	ENG	Degree
ODD	Display Hold After Defrost	ENG	Minute
SD	Start/Stop Defrost	CUS	Start/Stop
CFA	Clogged Filter Alarm	n/a	On/Off
CCR	Clogged Filter Compressor Run Time	n/a	Minute
CDL	Clogged Filter Alarm Temperature	n/a	Degree
DOA	Door Open Alarm	ENG	On/Off
DAD	Door Display Alarm Delay	ENG	Minute
APD	Alarm Pause Delay	ENG	Second
ATD	Alarm Temperature Delay	ENG	Second
AAS	Audible Alarm Style	CUS	On/Off
CL	Set The Clock Time	CUS	H/N/S
DAY	Set The Clock Date	CUS	Y/N/D
DS	Daylight Savings	CUS	On/Off
DL1	Defrost Lockout 1	CUS	Time/Off
DL2	Defrost Lockout 2	CUS	Time/Off
DL3	Defrost Lockout 3	CUS	Time/Off
DL4	Defrost Lockout 4	CUS	Time/Off
DCF	Dewpoint Correction Factor	CUS	%
CON	Compressor Default On Time	ENG	Minute
COF	Compressor Off Time	ENG	Minute
EL	Evaporator Coil Temperature	CUS	Degree
DL	Discharge Line Temperature	CUS	Degree
CB	Cabinet Air Temperature	CUS	Degree
PLn*	Display Line Voltage	ENG	Volts
RCO*	Cycle Compressor Relay	ENG	On/Off
RdF*	Cycle Defrost Relay	ENG	On/Off
RFA*	Cycle Blower/Fan Relay	ENG	On/Off
RDH*	Cycle Door Heater Relay	ENG	On/Off
PRO*	Go To Bootloader For Programming	ENG	
CEP*	Clear EEPROM & Load Defaults	ENG	
REF*	Software Version/Revision/Step	n/a	

*MIT II control version only.

VIII. CONTROL PARAMETERS

VIII. c - G-SERIES PARAMETER SETTINGS (MIT II Control Version):

Control Parameter	Freezer Models				Refrigerator Models		
	GF1	GF2	GF3	GF4	GR1	GR2	GR3
ADR*	2	2	2	2	2	2	2
BAU*	9.6	9.6	9.6	9.6	9.6	9.6	9.6
NAF*	ON	ON	ON	ON	ON	ON	ON
SPH	-5.2	0.1	0.1	32	38.1	39.2	39.2
SPL	-10	-4	-4	26.1	34	37	37
SHL	-8	-3.1	-3.1	30.2	36	39.2	39.2
SHH	-5.2	0.1	0.1	34	40	40	40
SLL	-13	-6.2	-6.2	26.1	32	34	34
SLH	-10	-4	-4	28	34	37	37
RO	0	0	0	0	0	0	0
HI	0.1	5	5	35.2	41	41	41
LO	-18.4	-10	-10	20	30.2	30.2	30.2
SCL	F	F	F	F	F	F	F
HAD	n/a	n/a	n/a	n/a	n/a	n/a	n/a
LAD	n/a	n/a	n/a	n/a	n/a	n/a	n/a
AC	3	3	3	3	3	3	3
DEF	ELE	ELE	ELE	ELE	OFF	ELE	OFF
IBD	4.0	4.0	4.0	4.0	1.0	2.0	1.0
DDC	20	20	20	20	10	20	10
CDE	75	75	75	75	45.1	70	45.1
DDE	2	2	2	2	2	2	2
BDD	1	1	1	1	0	0	0
BSD	32	32	32	32	32	32	32
ODD	10	10	10	10	10	10	10
SD	Starts a new defrost cycle at any time or stops a current defrost cycle.						
CFA	n/a	n/a	n/a	n/a	n/a	n/a	n/a
CCR	n/a	n/a	n/a	n/a	n/a	n/a	n/a
CDL	n/a	n/a	n/a	n/a	n/a	n/a	n/a
DOA	n/a	n/a	n/a	n/a	n/a	n/a	n/a
DAD	n/a	n/a	n/a	n/a	n/a	n/a	n/a
APD	n/a	n/a	n/a	n/a	n/a	n/a	n/a
ATD	n/a	n/a	n/a	n/a	n/a	n/a	n/a
AAS	n/a	n/a	n/a	n/a	n/a	n/a	n/a
CL	Set the hours and minutes in military time.						
DAY	Set the year, month, day of the month and day of the week.						
DS	ON	ON	ON	ON	ON	ON	ON
DL1	OFF	OFF	OFF	OFF	OFF	OFF	OFF
DL2	OFF	11:30am	OFF	OFF	OFF	OFF	OFF
DL3	OFF	5:30pm	OFF	OFF	OFF	OFF	OFF
DL4	OFF	OFF	OFF	OFF	OFF	OFF	OFF
DCF	n/a	n/a	n/a	n/a	n/a	n/a	n/a
CON	19	19	19	19	11	11	11
COF	7	7	7	7	10	10	10
EL	Will display evaporator coil temp in real time every time an arrow is pressed.						
DL	Will display discharge line temp in real time every time an arrow is pressed.						
CB	Will display cabinet air temp in real time every time an arrow is pressed.						
PLn*	Will display power line voltage in real time every time an arrow is pressed.						
RCO*	Turns ON/OFF the compressor relay for 10-seconds or until an arrow is pressed.						
RdF*	Turns ON/OFF the defrost relay for 10-seconds or until an arrow is pressed.						
RFA*	Turns ON/OFF the blower relay for 10-seconds or until an arrow is pressed.						
RDH*	Turns ON/OFF the door heater triac for 10-seconds or until an arrow is pressed.						
PRO*	Set the controller in receiving mode for programming.						
CEP*	Clear all controller memories and reloads the factory default parameters.						
REF*	Firmware revision in the format X9.9 (X=version, 9=major revision, 9=minor revision).						

*MIT II control version only.

VIII. CONTROL PARAMETERS

VIII. d - R-SERIES PARAMETER SETTINGS (MIT II Control Version):

Control Parameter	Refrigerator Models							
	RA1	RA2	RA3	RA4	RA5	RA6	RA7	RA8
ADR	2	2	2	2	2	2	2	2
BAU	9.6	9.6	9.6	9.6	9.6	9.6	9.6	9.6
NAF	ON	ON	ON	ON	ON	ON	ON	ON
SPH	39.2	39.2	39.2	39.2	38.1	38.1	39.2	39.2
SPL	37	37	37	37	34	34	37	37
SHL	39.2	39.2	39.2	39.2	36	36	39.2	39.2
SHH	40	40	40	40	40	40	40	40
SLL	34	34	34	34	32	32	34	34
SLH	37	37	37	37	34	34	37	37
RO	0	0	0	0	0	0	0	0
HI	41	41	41	41	41	41	41	41
LO	30.2	30.2	30.2	30.2	30.2	30.2	30.2	30.2
SCL	F	F	F	F	F	F	F	F
HAD	15	15	15	15	15	15	15	15
LAD	2	2	2	2	2	2	2	2
AC	3	3	3	3	3	3	3	3
DEF	OFF	OFF	OFF	OFF	OFF	OFF	ELE	ELE
IBD	1.0	1.0	1.0	1.0	1.0	1.0	2.0	2.0
DDC	10	10	10	10	10	10	20	20
CDE	45.1	45.1	45.1	45.1	45.1	45.1	70	70
DDE	2	2	2	2	2	2	2	2
BDD	0	0	0	0	0	0	0	0
BSD	32	32	32	32	32	32	32	32
ODD	10	10	10	10	10	10	10	10
SD	Starts a new defrost cycle at any time or stops a current defrost cycle.							
CFA	OFF	ON	OFF	ON	ON	ON	OFF	ON
CCR	20	20	20	20	20	20	20	20
CDL	220.1	220.1	220.1	220.1	220.1	220.1	220.1	220.1
DOA	ON	ON	ON	ON	ON	ON	ON	ON
DAD	15	15	15	15	15	15	15	15
APD	2	2	2	2	2	2	2	2
ATD	10	10	10	10	10	10	10	10
AAS	OFF	OFF	OFF	OFF	OFF	OFF	OFF	OFF
CL	Set the hours and minutes in military time.							
DAY	Set the year, month, day of the month and day of the week.							
DS	ON	ON	ON	ON	ON	ON	ON	ON
DL1	OFF	OFF	OFF	OFF	OFF	OFF	OFF	OFF
DL2	OFF	OFF	OFF	OFF	OFF	OFF	OFF	OFF
DL3	OFF	OFF	OFF	OFF	OFF	OFF	OFF	OFF
DL4	OFF	OFF	OFF	OFF	OFF	OFF	OFF	OFF
DCF	100	100	100	100	100	100	100	100
CON	11	11	11	11	11	11	11	11
COF	10	10	10	10	10	10	10	10
EL	Will display evaporator coil temp in real time every time an arrow is pressed.							
DL	Will display discharge line temp in real time every time an arrow is pressed.							
CB	Will display cabinet air temp in real time every time an arrow is pressed.							
PLn*	Will display power line voltage in real time every time an arrow is pressed.							
RCO*	Turns ON/OFF the compressor relay for 10-seconds or until an arrow is pressed.							
RdF*	Turns ON/OFF the defrost relay for 10-seconds or until an arrow is pressed.							
RFA*	Turns ON/OFF the blower relay for 10-seconds or until an arrow is pressed.							
RDH*	Turns ON/OFF the door heater triac for 10-seconds or until an arrow is pressed.							
PRO*	Set the controller in receiving mode for programming.							
CEP*	Clear all controller memories and reloads the factory default parameters.							
REF*	Firmware revision in the format X9.9 (X=version, 9=major revision, 9=minor revision).							

*MIT II control version only.

VIII. CONTROL PARAMETERS

VIII. e - R-SERIES PARAMETER SETTINGS (MIT II Control Version):

Control Parameter	Freezer Models				
	RF1	RF2	RF3	RF4	RF5
ADR	2	2	2	2	2
BAU	9.6	9.6	9.6	9.6	9.6
NAF	ON	ON	ON	ON	ON
SPH	-15.4	-10	0.1	0.1	-5.2
SPL	-20.2	-15.4	-4	-4	-10
SHL	-15.4	-13.6	-2.2	-2.2	-8
SHH	-10	-10	0.1	0.1	-5.2
SLL	-20.2	-20.2	-6.2	-6.2	-13
SLH	-17	-15.4	-4	-4	-10
RO	0	0	0	0	0
HI	5.2	5.2	5	5	0.1
LO	-25.6	-25.6	-10	-10	-17.8
SCL	F	F	F	F	F
HAD	15	15	15	15	15
LAD	2	2	2	2	2
AC	3	3	3	3	3
DEF	ELE	ELE	ELE	ELE	ELE
IBD	4.0	4.0	4.0	4.0	4.0
DDC	30	20	20	20	20
CDE	55	75	75	70	70
DDE	5	2	2	2	2
BDD	1	1	1	1	1
BSD	-10	32	32	32	32
ODD	10	10	10	10	10
SD	Starts a new defrost cycle at any time or stops a current defrost cycle.				
CFA	ON	OFF	OFF	ON	ON
CCR	20	20	20	20	20
CDL	220.1	220.1	220.1	220.1	220.1
DOA	ON	ON	ON	ON	ON
DAD	15	15	15	15	15
APD	2	2	2	2	2
ATD	10	10	10	10	10
AAS	OFF	OFF	OFF	OFF	OFF
CL	Set the hours and minutes in military time.				
DAY	Set the year, month, day of the month and day of the week.				
DS	ON	ON	ON	ON	ON
DL1	OFF	OFF	OFF	OFF	OFF
DL2	OFF	OFF	OFF	OFF	OFF
DL3	OFF	OFF	OFF	OFF	OFF
DL4	OFF	OFF	OFF	OFF	OFF
DCF	100	100	100	100	100
CON	19	19	19	19	19
COF	7	7	7	7	7
EL	Will display evaporator coil temp in real time every time an arrow is pressed.				
DL	Will display discharge line temp in real time every time an arrow is pressed.				
CB	Will display cabinet air temp in real time every time an arrow is pressed.				
PLn	Will display power line voltage in real time every time an arrow is pressed.				
RCO	Turns ON/OFF the compressor relay for 10-seconds or until an arrow is pressed.				
RdF	Turns ON/OFF the defrost relay for 10-seconds or until an arrow is pressed.				
RFA	Turns ON/OFF the blower relay for 10-seconds or until an arrow is pressed.				
RDH	Turns ON/OFF the door heater triac for 10-seconds or until an arrow is pressed.				
PRO	Set the controller in receiving mode for programming.				
CEP	Clear all controller memories and reloads the factory default parameters.				
REF	Firmware revision in the format X9.9 (X=version, 9=major revision, 9=minor revision).				

VIII. CONTROL PARAMETERS

VIII. f - UNDERCOUNTER PARAMETER SETTINGS (MIT II Control Version):

Control Parameter	UF1	UF2	UP1	UP2
ADR	2	2	2	2
BAU	9.6	9.6	9.6	9.6
NAF	ON	ON	ON	ON
SPH	0.1	38.1	38.1	38.1
SPL	-4	33.8	33.8	33.8
SHL	-0.31	36	36	36
SHH	0.1	40	40	40
SLL	-6.2	32	32	32
SLH	-4	34	34	34
RO	0	0	0	0
HI	5	41	41	41
LO	-10	30.2	30.2	30.2
SCL	F	F	F	F
HAD	15	15	15	15
LAD	2	2	2	2
AC	3	3	3	3
DEF	GAS	GAS	OFF	OFF
IBD	4.0	4.0	1.0	1.0
DDC	20	20	10	10
CDE	75	75	45.1	45.1
DDE	5	2	2	2
BDD	1	1	0	0
BSD	-10	32	32	32
ODD	10	10	10	10
SD	Starts a new defrost cycle at any time or stops a current defrost cycle.			
CFA	OFF	OFF	N/A	OFF
CCR	20	20	N/A	20
CDL	220.1	220.1	N/A	220.1
DOA	OFF	OFF	N/A	OFF
DAD	15	15	N/A	15
APD	2	2	2	2
ATD	10	10	N/A	10
AAS	OFF	OFF	N/A	OFF
CL	Set the hours and minutes in military time.			
DAY	Set the year, month, day of the month and day of the week.			
DS	ON	ON	ON	ON
DL1	OFF	OFF	OFF	OFF
DL2	OFF	OFF	OFF	OFF
DL3	OFF	OFF	OFF	OFF
DL4	OFF	OFF	OFF	OFF
DCF	100	100	100	100
CON	19	19	11	11
COF	7	7	10	10
EL	Will display evaporator coil temp in real time every time an arrow is pressed.			
DL	Will display discharge line temp in real time every time an arrow is pressed.			
CB	Will display cabinet air temp in real time every time an arrow is pressed.			
PLn	Will display power line voltage in real time every time an arrow is pressed.			
RCO	Turns ON/OFF the compressor relay for 10-seconds or until an arrow is pressed.			
RdF	Turns ON/OFF the defrost relay for 10-seconds or until an arrow is pressed.			
RFA	Turns ON/OFF the blower relay for 10-seconds or until an arrow is pressed.			
RDH	Turns ON/OFF the door heater triac for 10-seconds or until an arrow is pressed.			
PRO	Set the controller in receiving mode for programming.			
CEP	Clear all controller memories and reloads the factory default parameters.			
REF	Firmware revision in the format X9.9 (X=version, 9=major revision, 9=minor revision).			

HOURS OF OPERATION:

Monday thru Friday 7:30 am - 4:30 pm CST



Quality Refrigeration

Traulsen

4401 Blue Mound Road Fort Worth, TX 76106
Phone: (800) 825-8220 Fax-Svce: (817) 740-6757
Website: www.traulsen.com