

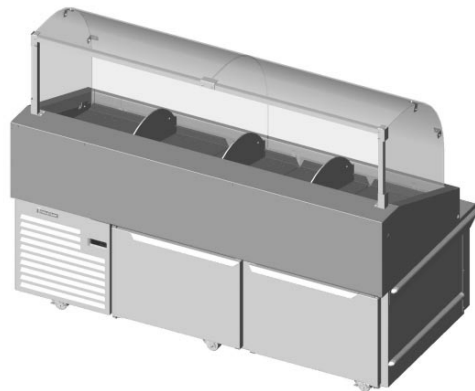

# OWNER'S MANUAL

## Instructions for the installation, operation and maintenance of Traulsen's Seafood Display Cabinet

\* Traulsen's seafood display cabinets were designed for optimal energy efficiency per Department of Energy requirements to be used with ice.



This Traulsen unit is built to our highest quality standards. We build our refrigerators, freezers and heated cabinets this way as a matter of pride. This philosophy has made Traulsen the leader in commercial refrigeration since 1938. We thank you for your choice and confidence in Traulsen equipment and we know you will receive many years of utility from this equipment.

All Traulsen units are placed on a permanent record file with the service department. In the event of any future questions you may have, please refer to the model and serial number found on the name tag affixed to the unit. Should you need service, however, call us on our toll free number, 800-825-8220 between 7:30 am and 4:30 pm CST, Monday thru Friday. It is our pleasure to help and assist you in every possible way.

### INSTALLER

#### COMPLETE THE FOLLOWING INFORMATION PRIOR TO UNIT INSTALLATION

INITIAL START DATE: \_\_\_\_\_ SERIAL NO. \_\_\_\_\_

MODEL TYPE: \_\_\_\_\_

COMPANY/INDIVIDUAL NAME: \_\_\_\_\_

INSTALLER: \_\_\_\_\_

# TABLE OF CONTENTS



## Part I - Cabinet Information

<b>I. THE SERIAL TAG</b>		Page 1
<b>II. RECEIPT INSPECTION</b>		Page 2
<b>III. INSTALLATION</b>		
a-Location		Page 2
b-Packaging		Page 2
c-Cord & Plug		Page 2
d-Power Supply		Page 2
e-Wiring Diagram		Page 2
f-Clearance		Page 2
g-Adjusting Supports		Page 2
<b>IV. OPERATIONS</b>		
a-Ice and Product Loading Guidelines	Page 3	
b-Periodic Ice Melt Removal	Page 3	
c-Cleaning The Display Area	Page 3	
d-Cleaning The Fans & Bearing Posts	Page 4	
e-Interior Arrangements	Page 4	
f-Transport Latch	Page 4	
g-Temperature Display	Page 4	
<b>V. CARE &amp; MAINTENANCE</b>		
a-Replacing The Gaskets	Page 4	
b-Cleaning The Exterior	Page 5	
c-Cleaning The Interior	Page 5	
d-Cleaning The Condenser Coil	Page 5	
<b>VI. OTHER</b>		
a-Service Information	Page 5	
b-Spare Parts	Page 5	

## Part II - Control Information

<b>VII. INTELA-TRAUL®</b>		Page 7
a-Control Features		Page 7
b-Alarm Explanations		Page 8
c-Control Panel		Page 9
d-Parts Assembly		Page 9
e-Notes To The User		Page 10
f-Enter The Customer Access Code		Page 10
g-Customer Service Parameters		Page 11
h-Adjusting Thermostat Set Point High		Page 11
i-Adjusting Thermostat Set Point Low		Page 12
j-Changing The Temperature Scale		Page 12
k-Setting The 24-Hour Clock		Page 13
l-Setting The Date		Page 14
m-Setting Daylight Savings Time		Page 14
n-Starting A Manual Defrost		Page 15
o-Setting Defrost Lockouts		Page 16
p-Adjusting The Room Temperature Offset		Page 17
q-Setting The Audible Alarm Style		Page 17
r-Viewing Sensor Temperatures		Page 18
<b>VIII. TROUBLE SHOOTING GUIDE</b>		Page 19
<b>IX. SPARE PARTS LIST</b>		Page 20
<b>X. WARRANTY INFORMATION</b>		Page 21
<b>XI. WIRING DIAGRAM</b>		Page 22

## PART I. CABINET INFO

 <small>FORT WORTH, TX.</small>			
<b>SERIAL</b>	<b>MODEL</b>	<b>PH</b>	
<b>VOLTS</b>			
<b>TOTAL CURRENT</b>	<b>AMPS</b>		
<b>MINIMUM CIRCUIT</b>	<b>AMPS</b>		
<b>MAXIMUM OVERCURRENT PROTECTION</b>		<b>AMPS</b>	
<b>LIGHTS</b>	<b>WATTS</b>		
<b>HEATERS</b>	<b>AMPS</b>		
<b>REFRIGERANT</b>	<b>TYPE</b>	<b>OZ</b>	
<b>DESIGN PRESSURE</b>	<b>HIGH</b>	<b>LOW</b>	
 			
370-60294-00 REV (A)			

### I. THE SERIAL TAG

The serial tag is a permanently affixed sticker on which is recorded vital electrical and refrigeration data about your Traulsen product, as well as the model and serial number. This tag is located in the refrigeration compartment of all seafood display cabinets.

#### READING THE SERIAL TAG

- Serial = The permanent ID# of your Traulsen
- Model = The model # of your Traulsen
- Volts = Voltage
- Hz = Cycle
- PH = Phase
- Total Current = Maximum amp draw
- Minimum Circuit = Minimum circuit ampacity
- Lights = Light wattage
- Heaters = Heater amperage (Hot Food units only)
- Refrigerant = Refrigerant type used
- Design Pressure = High & low side operating pressures and refrigerant charge
- Agency Labels = Designates agency listings

## II. RECEIPT INSPECTION

All Traulsen products are factory tested for performance and are free from defects when shipped. The utmost care has been taken in crating this product to protect against damage in transit. You should carefully inspect your Traulsen unit for damage during delivery. If damage is detected, you should save all the crating materials and make note on the carrier's Bill Of Lading describing this. A freight claim should be filed immediately. If damage is subsequently noted during or immediately after installation, contact the respective carrier and file a freight claim. Under no condition may a damaged unit be returned without first obtaining written permission (return authorization).

## III. INSTALLATION

### III. a - LOCATION:

Select a proper location away from extreme heat or cold. Allow enough clearance between the unit and the side wall in order to allow the doors to fully open.

### III. b - PACKAGING:

Unit is shipped from the factory strapped to a sturdy wooden pallet and protected by wood crating. The crating is attached to the pallet with several screws. These should first be removed to avoid scratching the unit when lifting off the crating.

Most exterior surfaces have a protective vinyl covering to prevent scratching during manufacturing, shipping, and installation. Remove after install and discard.

To remove the roadshow cabinet from the wooden pallet start by cutting free the nylon bands. Next, remove the screws attaching the two metal hold down brackets to the skid. Slide them out of the caster channel to remove, thus releasing the roadshow cabinet from the skid.

**NOTE: DO NOT LAY THE UNIT ON ITS SIDE DURING TRANSPORTATION OR INSTALLATION.**

### III. c - CORD & PLUG:

An attached cord & plug is provided, shipped coiled inside the compressor compartment (secured by a nylon strip). For your safety and protection, this includes a special three-prong grounding plug. Under no circumstances should you ever remove the round grounding prong from the plug.

**Select only an appropriate dedicated 20 amp outlet.**

To prevent cord and/or plug damage always secure the entire cord on the supplied cord wrap during transport (see fig. 1).

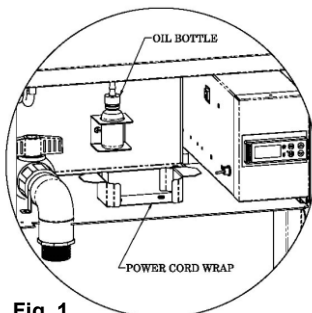

Fig. 1

## III. INSTALLATION (continued)

### III. d - POWER SUPPLY:

The supply voltage should be checked prior to connection to be certain that proper voltage for the cabinet wiring is available (refer to the serial tag for the correct unit voltage). Make connections in accordance with local electrical codes. Use qualified electricians. Use of a separate, dedicated circuit is required. Size wiring to handle indicated load and provide necessary over-current protector in circuit (see amp requirements on the unit's serial tag).

### III. e - WIRING DIAGRAM:

Refer to the wiring diagram on page 22 for any service work performed on the unit. Should you require a new one, please contact Traulsen Service at (800) 825- 8220, and provide serial number of the unit involved.

### III. f - CLEARANCE:

To assure optimum performance of your seafood display cabinet the condensing unit **MUST** have an adequate supply of air for cooling purposes. The operating location must have 31" minimum clearance in front of both the customer and operator side louvers. Select a working location away from extreme heat or cold. The seafood display cabinet is designed to operate in temps of 86°F (30°C) or less. Locate the unit so that air drafts (such as heat, A/C or ventilation) do not blow on or over the seafood display area.

### III. g - ADJUSTING SUPPORTS:

Unit includes 6 factory installed casters, 2 with brakes. For ease of mobility only the centerline casters are fixed. To set the brake, using your foot simply push this down into the locked position. Push up to release. Adjust the caster location by loosening the two bolts at the base of each caster (see fig. 2), then slide this along the mounting channel into the desired position. Tighten the two bolts to resecure the caster.

**NOTE:** When adjusting the caster location please note that these must always be installed towards the four corners of the unit, as well as the center, for proper cabinet support and mobility.

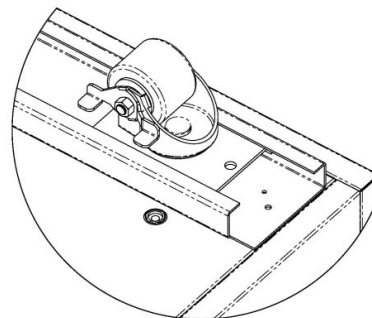

Fig. 2

**NOTE:** Cabinet is designed to be pushed from the left or right side for easy mobility. Pushing the cabinet from either the front (customer side) or back (operator side) can result in damage to the center set of casters.

## IV. OPERATIONS

### IV a. ICE & PRODUCT LOADING GUIDELINES:

Ice is not required for proper operation, but if used it should be loaded only up to the level of the lowest air baffles with product loaded no higher than the rail perimeter, indicated by load level labels (see fig 3).

**NOTE: Do Not Allow Ice to Collect Above Front Rim Where It Will Block Air-Flow.**

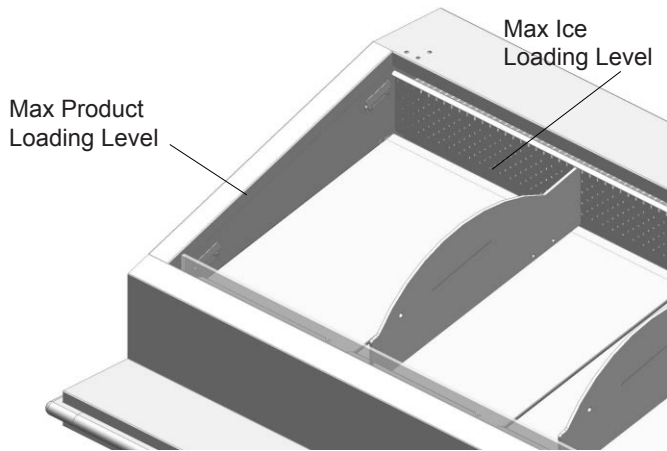

### IV b. PERIODIC ICE MELT REMOVAL:

In the event ice is used, the seafood display cabinet is designed to retain a significant amount of water (from the inevitable melting) below the display area. Up to 5 gallons of water can be held, and so may need occasional draining during the day. A float indicator is provided at the front of the cabinet to notify when draining is required (see fig. 4).

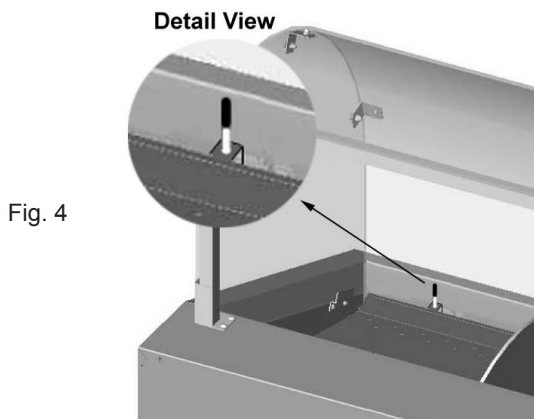

Fig. 4

### To drain the water...

Open the hinged louvered service door that covers the system end of the unit. It is on the same side as the refrigerated base doors. Pull it to open. A two foot flexible hose is provided to facilitate water removal.

Open the valve by rotating the drain handle 90° so that the handle is in line with the pipe. This will allow the water to drain out. When the water stops draining, close the valve and close the louvered service door.

### IV c. CLEANING THE DISPLAY AREA:

**CAUTION:** The power should be removed from the unit by unplugging the power cord from the power source before doing any cleaning or servicing of this unit.

#### For The Plastic Sneeze Shield

- 1) Remove the power from the unit.
- 2) Remove the plastic sneeze shield pieces by sliding out of their holders.
- 3) Remove screws holding the front panels to those on the side. Push canopy forward to remove from rear cross brace retaining brackets.
- 4) Wash the parts with a solution of mild dish soap and water and a soft cloth. Dry with a soft cloth.

#### **CAUTION:**

The use of any soap with chemicals (ex. Windex, 409, etc.) will cause the acrylic material to permanently blur.

- 5) Reinstall the sneeze shield pieces in the rear cross brace brackets.

#### For The Display Area

- 1) Remove the power from the unit.
- 2) Locate the unit so that the system end of the unit is located near an appropriate floor drain.
- 3) Open the louvered service door and position the enclosed hose over the floor drain.
- 4) Rotate the red handle on the main drain valve so that it is in line with the pipe. When you do this the residual condensate and ice melt will spill out.
- 5) Remove the ice pans.
- 6) Remove any cross bars (running front to back) and the two long support bars (running left to right).
- 7) Carefully remove the two sections of air baffles by folding down the vertical member and lifting the assemblies out of the unit. Care should be taken not to hit or damage the fan blades.
- 8) Carefully lift the fan blades off their bearing pins by holding the fan and lifting straight up. Place the fan blades in a safe location. They will be cleaned separately.
- 9) The display area can now be washed with a hose, cloth or other means available. All of the water used will come out of the main drain. Care should be taken not to hit the fan bearing pins with any hard objects. These are permanently installed.
- 10) After the unit is washed, dry with a squeegee, towels, or other means. Using a clean rag wipe the bearing pins clean and dry.
- 11) Replace the cleaned and oiled fan blades (see procedure following) on the pins.
- 12) Reinstall the parts in the reverse order, steps 7-2.
- 13) Close the main drain valve by rotating the red handle so that it is positioned across the pipe.

#### **CAUTION:**

Failure to close the drain pipe will result in the condensate and ice melt water dripping onto the floor the next time the unit is used.

#### IV. OPERATIONS (continued)

##### IV d. CLEANING THE FANS AND BEARING POSTS:

**NOTE: Fan and bearing MUST be cleaned and lubricated before every day of use.**

1) Using Q-Tips and Alcohol or Mineral Spirits, wipe the inside of the fan blade hole clean (see fig 5).

2) Use a dry Q-Tip to dry any remaining solvent inside the bearing surface. Check to make sure no cleaning material is left in the hole.

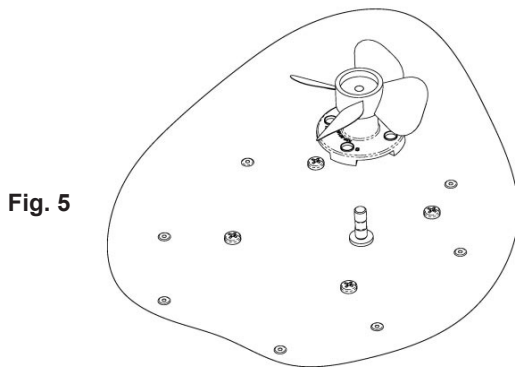

Fig. 5

3) Use a soft cloth or Q-Tip with Alcohol or Mineral Spirits to clean the area around the bearing surface bottom.

4) Place 8-drops of Traulsen supplied oil (p/n 377- 60061) into the bearing hole.

5) Place the fan onto the cleaned pin and move up and down to distribute the oil on the bearing pin

6) Repeat the process with the second fan

##### IV. e - INTERIOR ARRANGEMENTS:

The compartment behind each door is equipped to hold five 18" x 26" sheet pans.

##### IV. f - TRANSPORT LATCH:

A transport latch is provided to prevent the doors from opening while moving. Engage this by sliding the level to the left (see fig. 6).

6). To disengage slide to the right.

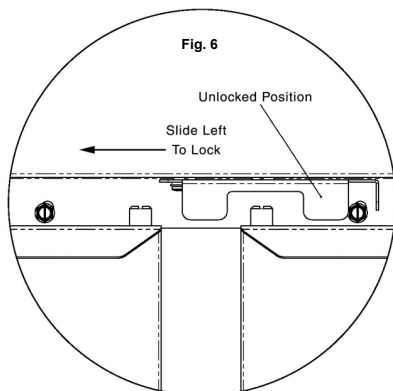

Fig. 6

##### IV. g - TEMPERATURE DISPLAY:

Two temperatures are displayed on the control,

- 1) Product Display Area (indicated by "R" see fig. 7) and
- 2) Cabinet Base (indicated by "C" see fig 8). These flash alternatively on the control display every ten seconds.



Fig. 7



Fig. 8

#### V. CARE & MAINTENANCE

##### WARNING

DISCONNECT ELECTRICAL POWER SUPPLY BEFORE CLEANING ANY PARTS OF THE UNIT

##### WARNING

DO NOT USE A SPRAY HOSE ON ANY AREA OTHER THAN INSIDE THE DISPLAY WELL. SPRAYING THE EXTERIOR OR INTERIOR BASE COULD RESULT IN SIGNIFICANT CABINET DAMAGE.

##### V. a - REPLACING THE GASKETS:

To remove a door gasket simply grasp it firmly by one corner and pull it out of its securing channel. Before attempting to install a new gasket, both the unit and the gasket itself must be at room temperature. Insert the four corners first by using a rubber mallet (or hammer with a block of wood). After the corners are properly inserted, work your way towards the center from both ends by gently hitting with a mallet until the gasket is completely seated in place (see figure 9 for proper gasket placement).

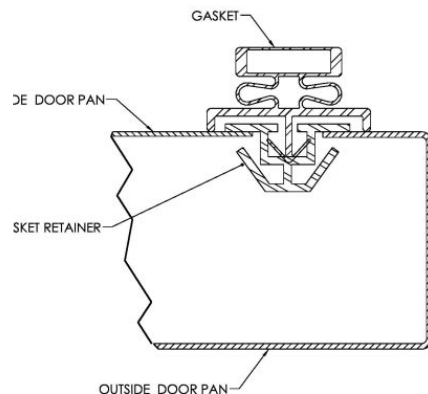

Fig. 9

**NOTE: The gasket may appear too large, but if it is installed as indicated above it will slip into place.**

## V. CARE & MAINTENANCE (continued)

### V. b - CLEANING THE EXTERIOR:

Exterior stainless steel should be cleaned with warm water, mild soap and a soft cloth. Apply with a dampened cloth wiping in the direction of the metal grain.

Avoid the use of strong detergents and gritty, abrasive cleaners as they may tend to mar and scratch the surface. Do NOT use cleansers containing chlorine, this may promote corrosion of the stainless steel.

Care should also be taken to avoid splashing the unit with water, containing chlorinated cleansers, when mopping the floor around the unit.

For stubborn odor spills, use baking soda and water (mixed to a 1 TBSP baking soda to 1 pint water ratio).

### V. c - CLEANING THE CABINET INTERIOR BASE:

For cleaning both stainless steel and anodized aluminum interiors, the use of baking soda as described in section "V. b" is recommended. Use on breaker strips as well as door gaskets. All interior fittings are removable without tools to facilitate cleaning.

### V. d - CLEANING THE CONDENSER COIL:

To clean the condenser open the door to access the compressor compartment. Proceed to wipe, brush or vacuum any dirt, lint or dust from the finned condenser coil, as well as from the the compressor and other refrigeration system parts. If significant dirt is clogging the condenser fins or filter, use compressed air to blow this clear.

Close the door when done

## VI. OTHER

### VI. a - SERVICE INFORMATION:

Before calling for service, please check the following:

Is the electrical cord plugged in?

Is the fuse OK or circuit breaker on?

Is the power switch "ON"?

If after checking the above items and the unit is still not operating properly, please contact an authorized Traulsen service agent. A complete list of authorized service agents was provided along with your Traulsen unit. If you cannot locate this, you may also obtain the name of a service agent from the Service/Contact page of our website: [www.traulsen.com](http://www.traulsen.com).

If service is not satisfactory, please contact our in-house service department at:

Traulsen  
4401 Blue Mound Road  
Fort Worth, TX 76106  
(800) 825-8220

Traulsen reserves the right to change specifications or discontinue models without notice.

### VI. b - SPARE PARTS:

Spare or replacement parts may be obtained through a parts supplier or one of our authorized service agents. A complete list of authorized service agents accompanies this manual and is also posted on our company's official website @ [www.traulsen.com](http://www.traulsen.com).

PART II. CONTROL INFO

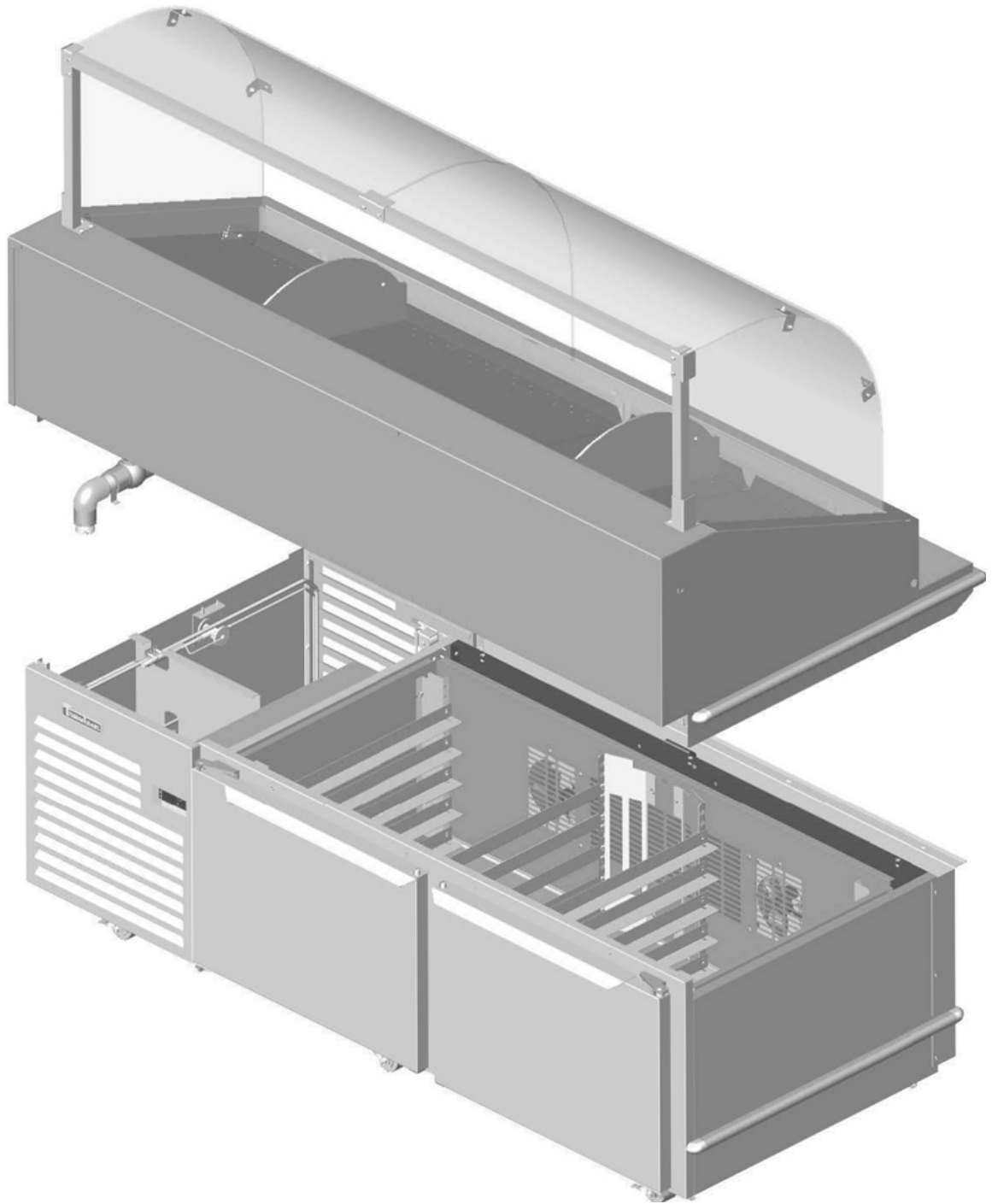

## VII. INTELA-TRAUL®

Your new Traulsen Seafood Display Cabinet is equipped with a state-of-the-art electronic microprocessor INTELA-TRAUL® control, which precisely regulates operation and provides alarms when problems occur. It is supplied from the factory completely ready for use but without the audible alarms activated. See pages 8 thru 17 for more information.

### VII. a - INTELA-TRAUL® CONTROL FEATURES:

#### Internal Time Clock

- Eliminates defrost time clock.

#### Parameter/Service Levels

- See “**Customer / Service Parameters**” on Page 10.

#### Alarms (See the following pages for explanations)

- High Cabinet Air Temperature
- Low Cabinet Air Temperature
- CONDENSERCLEAN\*
- Sensor Failures

**VII. b - ALARM EXPLANATIONS:**

**\*NOTE:** Explanation of alarms assume the audible alarm style is set at a 3-second burst or a continuous audible alarm. References to the audible alarm do not apply if the audible alarm style is set to OFF (Refer to page 17 for setting the audible alarm style).



**High Cabinet Air Temperature:** The audible alarm\* will sound and the display will read Hi Cab when the temperature inside the cabinet rises above a pre-programmed limit. The limit is determined by the type of unit being operated (i.e.: refrigerator/freezer). To turn off the audible alarm\*, press the alarm cancel button. The visual alarm text will continue to display until the cabinet air temperature falls below the limit. If the temperature does not fall below the limit within 5 minutes, the audible alarm\* will sound again and an additional Call Service message will display.

**POSSIBLE CAUSES:**

- Doors open for extended periods of time.
- Large amounts of hot product placed inside the cabinet.
- Condenser coil dirty.



**Low Cabinet Air Temperature:** The audible alarm\* will sound and the display will read Lo Cab when the temperature inside the cabinet falls below a pre-programmed limit. The limit is determined by the type of unit being operated (i.e.: refrigerator/ freezer). To turn off the audible alarm\*, press the alarm cancel button. The visual alarm text will continue to display until the cabinet air temperature rises above the limit. If the temperature does not rise above the limit within 5 minutes, the audible alarm\* will sound again and an additional Call Service message will display.

**POSSIBLE CAUSES:**

- No product in unit.
- Failed sensors.



**System Leak:** The audible alarm\* will sound and the display will read Call Service, when the control detects a leak in the refrigeration system. To turn off the audible alarm\*, press the alarm cancel button. The visual alarm text will remain until a service technician has repaired the unit. If the condition remains for 24 hours, the audible alarm\* will sound again.

**POSSIBLE CAUSES:**

- Low refrigerant charge.
- Discharge sensor has failed low.



**Sensor Failure:** The audible alarm\* will sound and the display will read Sensor Failure Call Service, when any of the unit sensors fail to operate. To turn off the audible alarm\*, press the alarm cancel button. The visual alarm text will remain until the sensor has been replaced. Depending on the function of the sensor, the audible alarm\* will sound again in either 5 minutes or 24 hours.

\*Not available on remote models.

VII. INTELA-TRAUL® (continued)

VII.e - CONTROL PANEL:

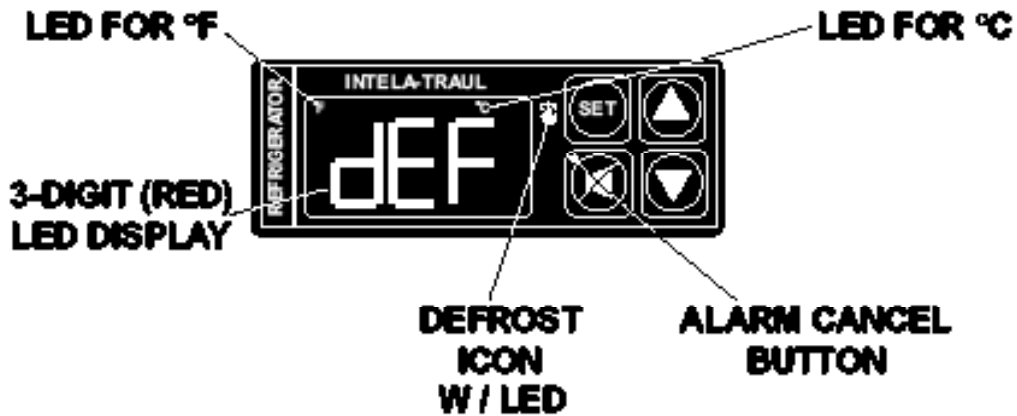

VII.d - PARTS ASSEMBLY:

COIL SENSOR\*  
337-60406-03  
BLUE



CABINET SENSOR\*  
337-60407-02  
YELLOW



RAIL SENSOR\*  
337-60405-03  
GREEN



HORN\*  
337-60070-00



INTELA-TRAUL\*\*  
HORIZONTAL  
CONTROLLER  
337-60403-00

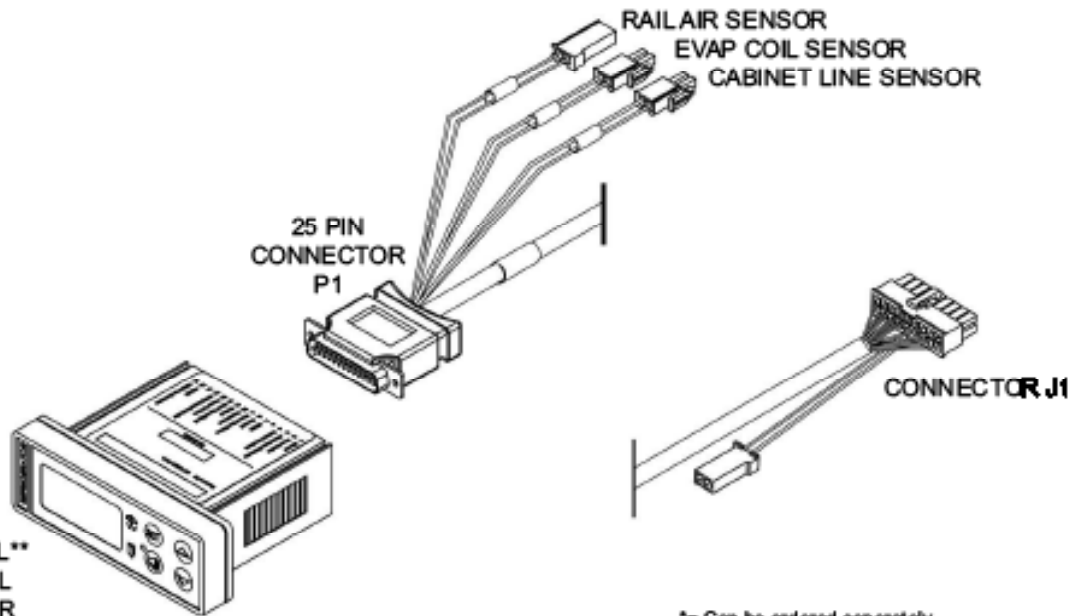

\*= Can be ordered separately



\*\*=Requires unit Model No. & S/N to place order.

**VII. e - NOTES TO THE USER:**

You only have 20-30 seconds between button pushes. If you take longer than 30 seconds, the controller will revert back to displaying the rail and box temperature. If you enter the wrong security code, the controller will revert back to displaying the rail and box temperature. You can exit the parameters at any time by pressing the alarm cancel button or by waiting 20-30 seconds.

**VII. f - ENTER THE CUSTOMER ACCESS:**

Use the security code 0, A, 1  and the following instructions:

Press the set button  . The display will read  Customer/Service Access.

Press the set button  .

The display will show three zeros with the left zero flashing    
 ↓

Press the set button  .

The display will show three zeros with the center zero flashing    
 ↑

Press the down arrow key  to sequence through F, E, d, C, b, A, 9, 8, 7,...etc.

When you reach A press set  .

The display will show zero, A, zero with the right zero flashing    
 ↓

Press the up arrow key  to sequence through 1, 2, 3, 4, 5, 6, 7, 8, 9, A, b,...etc.





















When you reach 1 press set  .

The display will read  Rail Set Point High.

You are now in the CUSTOMER / SERVICE PARAMETERS.

**VI. g - CUSTOMER SERVICE PARAMETERS:**

Listed below are the available parameters in the order they appear, using the down arrow key on the controller. You can use either the up or down arrow keys to scroll through the options.

 Set Rail Temp High	 Defrost Lockout 2
 Set Base Temp High	 Defrost Lockout 3
 Temperature Scale	 Defrost Lockout 4
 Audible Alarm Style	 Room Temp Offset Rail
 Time (24-hour clock)	 Room Temp Offset Base
 Date (month - day - year)	 Ambient Air Sensor
 Daylight Savings	 Evaporator Coil Sensor
 Start Manual Defrost	 Rail Line Sensor
 Defrost Lockout 1	 Relative Humidity Sensor
 Set Base Temp Low	 Set Rail Temp Low

**VI. h - ADJUSTING THE THERMOSTAT SET POINT HIGH:**

This parameter sets the high point of the desired rail and base temperature ranges. Typically, freezers will range from -3° F to 0° F (-19° C to -18° C) and refrigerators will range from 36° F to 40° F (2° C to 4° C) for this parameter setting. This parameter is preset at the factory and does not have to be adjusted unless the customer chooses to do so. Note: Set Point Low and Set Point High cannot be set to the same temperature. There will be at least 1-2 degree difference between the two settings.

Follow the instructions to enter the customer access code on page 10. When the control

display reads  Rail Set Point High. Press the set button .

Use the arrow keys   to adjust the temperature to your desired setting.

When the display shows the temperature you want press the set button .

The display will then read  Rail Set Point High.











You can use the up or down arrow keys to scroll to the next parameter  .

or press the alarm cancel button to exit .

**VII.I - ADJUSTING THE THERMOSTAT SET POINT LOW:**











This parameter sets the low point of the desired rail and base temperature ranges. Typically, freezers will range from -8° F to -4° F (-21° C to -20° C) and refrigerators will range from 32° F to 34° F ( 0° C to 1° C) for this parameter setting. This parameter is preset at the factory and does not have to be adjusted unless the customer chooses to do so. **Note:** Set Point Low and Set Point High cannot be set to the same temperature. There will be at least 1-2 degree difference between the two settings.

Follow the instructions to enter the customer access code on page 10. When the control displays

 press . Use the arrow keys   to adjust the temperature to your desired setting. When the display shows the temperature you want press . Use the up or down arrow keys to scroll to , then press . When the display shows the temperature you want press . You can press the   arrow keys to scroll to the next parameter or press the alarm cancel button to exit .

**VII.J - Changing The Temperature Scale:**

The temperature scale determines if the temperature displayed will be in degrees Fahrenheit or degrees Celsius.

Follow the instructions to enter the customer access code on page 10. Press  until the control display reads  Temperature Scale. Press the set button . The display will start with the current setting either  for degrees Fahrenheit or  for degrees Celsius. Use the arrow keys   to toggle between the options. When the display shows the scale you want press the set button . You can use the up or down arrow keys   to scroll to the next parameter or press the alarm cancel button to exit .



**VII. k - SETTING THE 24-HOUR CLOCK:**

The internal timeclock must be set in order for the data storage memory to correctly log events and to allow any defrost lockout to occur at the correct time of day. If the clock is not set, the control assumes the time is 12 am at the time power is supplied to the unit. The hours on a 24-hour time clock read the following way:

H01 = 1:00 a.m.	H07 = 7:00 a.m.	H13 = 1:00 p.m.	H19 = 7:00 p.m.
H02 = 2:00 a.m.	H08 = 8:00 a.m.	H14 = 2:00 p.m.	H20 = 8:00 p.m.
H03 = 3:00 a.m.	H09 = 9:00 a.m.	H15 = 3:00 p.m.	H21 = 9:00 p.m.
H04 = 4:00 a.m.	H10 = 10:00 a.m.	H16 = 4:00 p.m.	H22 = 10:00 p.m.
H05 = 5:00 a.m.	H11 = 11:00 a.m.	H17 = 5:00 p.m.	H23 = 11:00 p.m.
H06 = 6:00 a.m.	H12 = 12:00 p.m.	H18 = 6:00 p.m.	H24 = 12:00 a.m.

Follow the instructions to enter the customer access code on page 10. When the control

displays  Rail Set High, press the down arrow key  until the control

display reads  Clock. Press the set button .

The display will show  Hours. The right two numbers will be flashing.

Use the arrow keys   to set the hour.

When the correct hour is displayed, press the set button .

The display will show  Minutes. The right two numbers will be flashing.

Use the arrow keys to set the minutes  .





















When the correct minutes are displayed, press the set button .

The display will then read  Rail Set Point High.















You can use the up or down arrow keys   to scroll to the next parameter

or press the alarm cancel button to exit .

**VII.1 - SETTING THE DATE:**

The date must be set in order for the data storage memory to correctly log events. Follow the instructions to enter the customer access code on page 10. When the control displays  Rail Set Point High, press the down arrow key  until the control display reads  Date. Press the set button . The display will show  (year). The right two numbers will be flashing. Press the arrow keys   to set the year. When the correct year is displayed, press the set button . The display will show  (month). The right two numbers will be flashing. Use the arrow keys   to set the month. When the correct month is displayed, press the set button . The display will show  (day). The right two numbers will be flashing. Press the arrow keys   to set the day. When the correct day is displayed, press the set button . The display will then read  Rail Set Point High. You can use the up or down arrow keys   to scroll to the next parameter, press the alarm cancel button to exit .

**VII.2 - SETTING DAYLIGHT SAVINGS TIME:**

This parameter is preset at the factory to automatically adjust the 24-hour clock for Daylight Savings Time. Follow the instructions to enter the customer access code on page 9. When the control displays  Rail Set Point High, press the down arrow key  until the display reads  Daylight Savings Time. Press the set button . The display will show  Daylight Savings Time (Yes, automatically adjust for Daylight Savings Time). For "YES" press the set button ; for "NO" press the up or down arrow key  . The display will read  Daylight Savings Time (no). Press the set button . The display will read  Rail Set Point High. You can press the the up or down arrow keys   to scroll to the next parameter or press the alarm cancel button to exit .

**VII. n - STARTING A MANUAL DEFROST CYCLE:**

This parameter allows a service technician to start a defrost cycle at any time. This parameter will override any lockout settings.

Follow the instructions to enter the customer access code on page 10. When the control

displays  Rail Set High, press the down arrow key  until the control

display reads  Start Manual Defrost.

Press the set button .

The display will show  (OFF).

Press either arrow key   (YES).

The display will show .

Press the set button .

The display will then read  Rail Set Point High.

You can use the up or down arrow keys   to scroll to the next parameter

or press the alarm cancel button to exit .



The defrost icon will be lit, and the display will read  when the unit is in defrost.  will continue to be displayed until the unit recovers temperature.

DEFROST ICON

**NOTE:** Traulsen refrigerator units also have an off-cycle defrost once an hour, at which time the control will read . This defrost is temperature terminated and can last from 3 - 10 minutes (DEF will be displayed for 22-27 minutes time).

**VII. e - SETTING THE DEFROST LOCKOUTS:**

The defrost lockout parameters allow the customer to prevent the unit from going into a defrost cycle for two hours during a set time frame. Customers can set up to four defrost lockout parameters. They are all programmed the same way. The parameters will be set for the time the lockout is to start. The controller automatically calculates 2 hours from that setting. The options are similar to the 24-hour clock settings and are in 30-minute increments. Each of the lockout parameters covers 6 hours of the 24-hour clock. Note: The 24-hour clock must be set for this feature to operate at the correct time of day. See "Setting the 24-Hour Clock" on page 12.

Sample:



OFF

OFF

OFF

OFF

020 = 2:00 a.m.

080 = 8:00 a.m.

140 = 2:00 p.m.

200 = 8:00 p.m.

023 = 2:30 a.m.

083 = 8:30 a.m.

143 = 2:30 p.m.

203 = 8:30 p.m.

030 = 3:00 a.m.

090 = 9:00 a.m.

150 = 3:00 p.m.

210 = 9:00 p.m.

033 = 3:30 a.m.

093 = 9:30 a.m.

153 = 3:30 p.m.

213 = 9:30 p.m.

040 = 4:00 a.m.

100 = 10:00 a.m.

160 = 4:00 p.m.

220 = 10:00 p.m.

043 = 4:30 a.m.

103 = 10:30 a.m.

163 = 4:30 p.m.

223 = 10:30 p.m.

050 = 5:00 a.m.

110 = 11:00 a.m.

170 = 5:00 p.m.

230 = 11:00 p.m.

053 = 5:30 a.m.

113 = 11:30 a.m.

173 = 5:30 p.m.

233 = 11:30 p.m.

060 = 6:00 a.m.

120 = 12:00 p.m.

180 = 6:00 p.m.

240\* = 12:00 a.m.

063 = 6:30 a.m.

123 = 12:30 p.m.

183 = 6:30 p.m.

243\* = 12:30 a.m.

070 = 7:00 a.m.

130 = 1:00 p.m.

190 = 7:00 p.m.

010 = 1:00 a.m.

073 = 7:30 a.m.

133 = 1:30 p.m.

193 = 7:30 p.m.

013 = 1:30 a.m.

080 = 8:00 a.m.

140 = 2:00 p.m.

200 = 8:00 p.m.

020 = 2:00 a.m.

\* Denotes not available.

A lockout can not be programmed to start at 12:00 am or 12:30 am due to conflicts with other internal programs. The defrost lockouts can not be programmed to run back-to-back. For example, if dL1 is set to 080, then a defrost cycle would be locked out from 8:00 am to 10:00 am. Because of the dL1 setting the dL2 parameter would not let the user choose a lockout start time before 10:30 am. All lockouts are preset at the factory to OFF.

Follow the instructions to enter the customer access code on page 10. When the control

displays Rail Set High, press the down arrow key until the control the

control display reads or . Press the set button .

The display will show Off. Press the arrow keys to set the start time.

When the correct time is displayed, press the set button .

The display will then read Rail Set Point High.















You can press the up or down arrow keys to scroll to the next parameter

or press the alarm cancel button to edit .

**VII. p - ADJUSTING THE ROOM TEMPERATURE OFFSET:**

The room temperature offset parameter allows a service technician or end user the ability to have the display show a temperature that is within three degrees of the actual temperature being read by the cabinet air sensor. This allows for continuity of reading between different temperature reading devices. (i.e.: thermistor Vs thermocouple Vs handheld thermometer) This parameter is preset at the factory to "0" or no offset.















Follow the instructions to enter the customer access code on page 10. When the control displays

 Room Temperature Offset Fall press . Use the arrow keys   to adjust the offset to your desired setting then press . Press the up or down arrow keys   until the control displays Room Temperature Offset Base , then press . Use the arrow keys   to adjust the offset to your desired setting then press . You can use the up or down arrow keys   to scroll to the next parameter or press the alarm cancel button to exit .

**VII. q - SETTING THE AUDIBLE ALARM STYLE:**







This parameter will allow the customer to turn on/off the audible alarm feature on the INTELA-TRAUL® control. The audible alarm is preset from the factory to OFF. The customer can choose between an audible alarm that sounds for 3 seconds then automatically turns off, or a continuous audible alarm that must be manually acknowledged. Regardless of this feature's setting, visual alarm text will display when conditions warrant.

To adjust this setting, follow the instructions to enter the customer access code on page 10. When the

control displays  Rall Set Point High, press the up arrow key  until the display reads  Audible Alarm Style. Press the set button . The display will read  OFF. Use the arrow keys   to scroll between  for the 3-Second Audible Alarm Burst or  for Continuous Audible Alarm. When the display shows your choice of style, press the set button . The display will then read  Rall Set Point High. Use the arrow keys   to scroll to the next parameter or press the Alarm Cancel Button  to exit.

**VII. F - VIEWING SENSOR TEMPERATURES:**

These parameters allow a service technician or customer to view the temperature of all sensors within the unit. The temperatures cannot be adjusted.

Follow the instructions to enter the customer access code on page 10. When the control displays Rail Set Point High , press the DOWN arrow key  until the display reads Evaporator Coil Sensor  or Rail Line Sensor  or press the SET button . The display will read Thermostat Set Point High 

Press the UP or DOWN arrow keys   to scroll through the parameters or press the ALARM CANCEL button  to exit.

## VIII. TROUBLE SHOOTING GUIDE

FIND YOUR PROBLEM HERE	REMEDY
1. Condensing unit fails to start.	<ul style="list-style-type: none"> <li>a. Check if cord &amp; plug has been disconnected.</li> <li>b. Check INTELA-TRAUL® temperature setting.</li> <li>c. Check if power switch is in the ON position.</li> </ul>
2. Condensing unit operates for prolonged periods or continuously.	<ul style="list-style-type: none"> <li>a. Are doors closing properly?</li> <li>b. Dirty condenser or filter. Clean properly.</li> <li>c. Evaporator coil iced. Needs to defrost. See instructions for setting a manual defrost cycle on page 15.</li> <li>d. Shortage of refrigerant, call service.</li> <li>e. Canopy not installed correctly. Install correctly.</li> <li>f. Air drafts blowing into display area. Relocate unit</li> </ul>
3. Product rail is too warm.	<ul style="list-style-type: none"> <li>a. Check doors and gaskets for proper seal.</li> <li>b. Perhaps proper air flow is being blocked by excessive product, ice, or both. Remove obstruction(s).</li> <li>c. INTELA-TRAUL® setting too high, readjust per instructions on page 11.</li> <li>d. Too much water in product rail interfering with fan operation. Drain water.</li> <li>e. Air drafts blowing into display area. Relocate unit.</li> </ul>
4. Food compartment is too cold.	<ul style="list-style-type: none"> <li>a. Perhaps a large quantity of very cold or frozen food has recently been added. Allow adequate time for the cabinet to recover its normal operating temperature.</li> <li>b. Adjust the INTELA-TRAUL® to a warmer setting, see page 12.</li> </ul>
5. Compressor hums but does not start.	Call for service.
6. Rail fans making excessive noise or not rotating properly.	<ul style="list-style-type: none"> <li>a. Fans require daily cleaning or lubrication.</li> <li>b. Fans not installed correctly. Refer to page 4 for proper cleaning and installation details.</li> </ul>
7. Refrigerated base too warm.	<ul style="list-style-type: none"> <li>a. Ice covering rail sensor. Clear away ice.</li> <li>b. Door not closed. Close door.</li> <li>c. Check doors and gaskets for proper seal.</li> </ul>

## IX. SPARE PARTS LIST

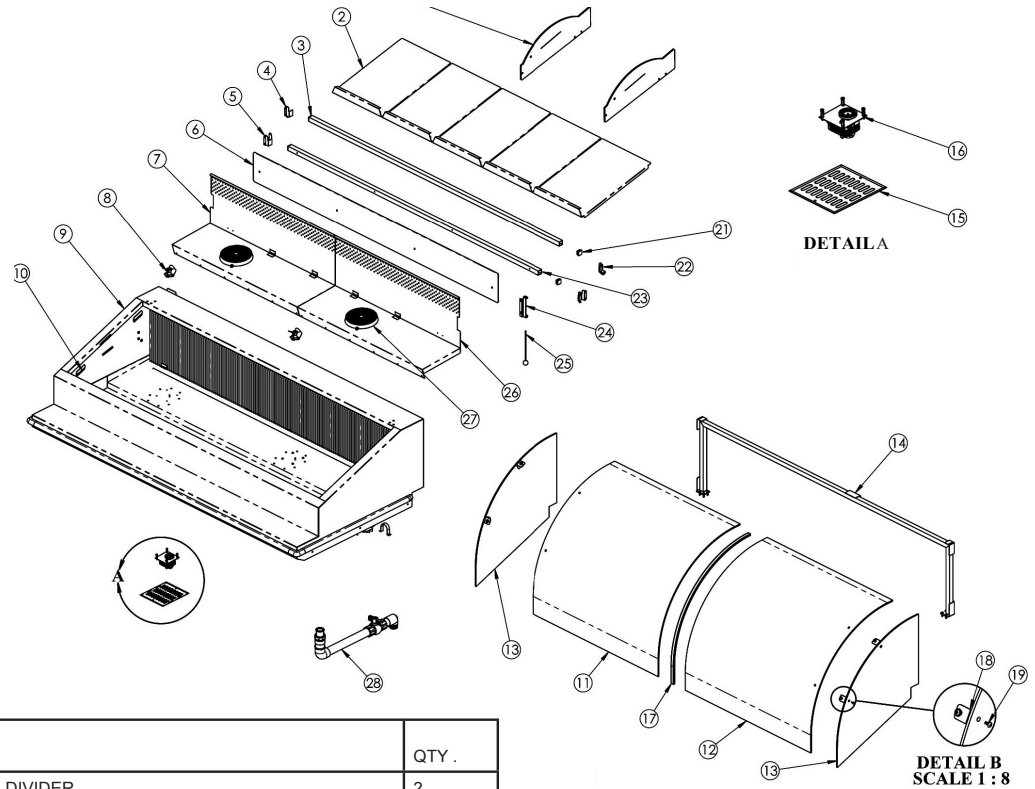

ITEM NO.	PART NUMBER	DESCRIPTION	QTY .
1	<a href="#">377-60060-00</a>	FISH DISPLAY PAN DIVIDER	2
2	<a href="#">701-61366-00</a>	PAN, FLAT 14.5" X 20.8" FOR ICE	5
3	<a href="#">712-60238-00</a>	BAR,PREP TOP PAN SUPPORT	1
4	<a href="#">510-10396-02</a>	BRACKET,PAN SUPPORTS END LT REAR	1
5	<a href="#">510-10396-00</a>	BRACKET,PAN SUPPORTS END FRONT	2
6	<a href="#">701-61332-01</a>	FRONT DISP. AIR BAFFLELARGE	1
7	<a href="#">700-60374-00</a>	PARTITION, FAN ORIFICEASSY . LT	1
8	SER-60552-00	FAN BLADE& HUB ASSBvIBLY	2
9	000-60316-00	FOAIVED TOP,FISH DISP	1
10	<a href="#">510-10451-00</a>	BRACKET SUPPORT, PLASTIC ASSY .	4
11	<a href="#">377-60055-21</a>	PANEL, FRONT LT CANOPY (AS VIE.W FROM CUST. SIDE)	1
12	<a href="#">377-60055-20</a>	PANEL, FRONT RTCANOPY (AS VIE.W FROM CUST. SIDE)	1
13	<a href="#">377-60055-19</a>	PANEL, CANOPY SIDE	2
14	<a href="#">176-28033-00</a>	PHANTOM, SUPPORT BAR FOR CANOPY	1
15	<a href="#">601-61131-00</a>	COVER, IVDTOR ASSBvIBLY	2
16	<a href="#">SER-60540-00</a>	MOTOR, ASSY .	2
17	<a href="#">377-60062-01</a>	DISPLAY CANOPY JOINER	1
18	<a href="#">176-28044-00</a>	BRKT.ASSY .SIDE/TOP CANOPY	4
19	<a href="#">351-12798-06</a>	SCRE.W MACHNE 10-32X 1/2 PHILLIPS TRUSS S/S	8
20	<a href="#">326-60474-00</a>	90 DEG ELBOW,1-1/4" PIC STREET-L	1
21	<a href="#">353-60023-00</a>	PLUG, SQUARE HOLE .875	4
22	<a href="#">510-10396-03</a>	BRACKET,PAN SUPPORTS END RT REAR	1
23	<a href="#">712-60238-01</a>	BAR, PREP TOP PAN SUPPORT	1
24	<a href="#">510-10441-00</a>	BRACKET WATER LEVEL & CANOPY TIXI78	5
25	<a href="#">700-60404-00</a>	FLOAT BALL-RODASSY , FISHDISP.	1
26	<a href="#">700-60375-00</a>	PARTITION, FAN ORIFICEASSY . RT	1
27	<a href="#">325-60102-00</a>	FANGUARD	2
28	<a href="#">SER-60560-00</a>	KIT DRAINWNALVE	1
29	<a href="#">348-10013-00</a>	4" CASTER W/ADJ. CHANNEL (W/O BRAKE)	2
30	<a href="#">348-10013-01</a>	4" CASTER W/ADJ. CHANNEL (WITH BRAKE)	2
31	<a href="#">348-10013-02</a>	4" CASTER W/ADJ. CHANNEL (FIXED)	2

## X. WARRANTY INFORMATION



### STANDARD DOMESTIC WARRANTY

TRAUlsen warrants new equipment to the original purchaser, when installed within the United States against defective material and workmanship for three (3) years from the date of original installation. Under this warranty, TRAUlsen will repair or replace, at its option, including service and labor, all parts found to be defective and subject to this warranty. Warranty term begins upon the date of installation, the date of End User Invoice or the date of Dealer Invoice, whichever is proven to occur latest, not to exceed 18 months from Dealer Invoice date (the "Warranty Period"). Warranty excludes components that are removable without tools.

The compressor part is warranted for an additional two (2) years. During this period TRAUlsen will supply replacement compressor(s) if deemed defective, however all installation, recharging and repair costs will remain the responsibility of the owner.

This warranty does not apply to damage resulting from fire, water, burglary, accident, abuse, misuse, transit, acts of God, terrorism, attempted repairs, improper installation by unauthorized persons, and does not apply to food loss.

For Traulsen units purchased with a remote feature, standard warranty will apply only to those components contained within the unit to the point of connection of the refrigeration lines leading to the remote condenser.

"Defective Part Return" – All claimed defective replacement part(s) must be returned to TRAUlsen for inspection within 30 days from the date of the repair. Failure to return all claimed defective part(s) to TRAUlsen will invalidate the warranty claim, this warranty statement, and forfeit payment for those repairs affected.

### INTERNATIONAL COMMERCIAL WARRANTY

TRAUlsen warrants to the original purchaser the Refrigeration Equipment shall be manufactured free from defects in material and workmanship under normal use and service for a period of one (1) year from date of shipment. Under this warranty, TRAUlsen will reimburse the purchaser for the replacement of any part of said equipment (excluding dryers & refrigerant gas) which then proves to be defective. This warranty does not apply to damage resulting from fire, water, burglary, accident, abuse, misuse, transit, acts of God, terrorism, attempted repairs, improper installation by unauthorized persons, and will not apply to food loss.

TRAUlsen's standard warranty does not apply to Export Sales. Rather, for a period of one (1) year from date of original installation not to exceed Fifteen (15) months from date of shipment from factory, TRAUlsen will, at Traulsen's sole discretion, replace or repair, F.O.B. factory, any defective parts normally subject to warranty and will not cover the cost of packing, freight or labor, such costs being the sole responsibility of the dealer.

THERE ARE NO ORAL, STATUTORY OR IMPLIED WARRANTIES APPLICABLE TO TRAUlsen, INCLUDING BUT NOT LIMITED TO, ANY IMPLIED WARRANTY OF MERCHANTABILITY OR FITNESS FOR ANY PARTICULAR PURPOSE WHICH EXTEND BEYOND THE DESCRIPTION ON THE FACE HEREOF. TRAUlsen SHALL HAVE NO OBLIGATION OR LIABILITY FOR CONSEQUENTIAL OR SPECIAL DAMAGES, INCLUDING, BUT NOT LIMITED TO, INDIRECT, PUNITIVE DAMAGES, LOSS OF USE, LOSS OF PRODUCT, DOWNTIME OR LOST PROFITS, GROWING OUT OF OR WITH RESPECT TO THE EQUIPMENT OR ITS SALE, OPERATION OR USE, AND TRAUlsen NEITHER ASSUMES NOR AUTHORIZES ANYONE ELSE TO ASSUME FOR IT ANY OBLIGATION OR LIABILITY IN CONNECTION WITH THE EQUIPMENT OR ITS SALE, OPERATION OR USE OTHER THAN AS STATED HEREIN.

THIS WARRANTY IS IN LIEU OF ALL OTHER WARRANTIES EITHER EXPRESSED OR IMPLIED AND CONSTITUTES TRAUlsen'S FULL OBLIGATION AND LIABILITY. WARRANTIES NOT AVAILABLE ON REMOTE MODELS.

XI. WIRING DIAGRAM

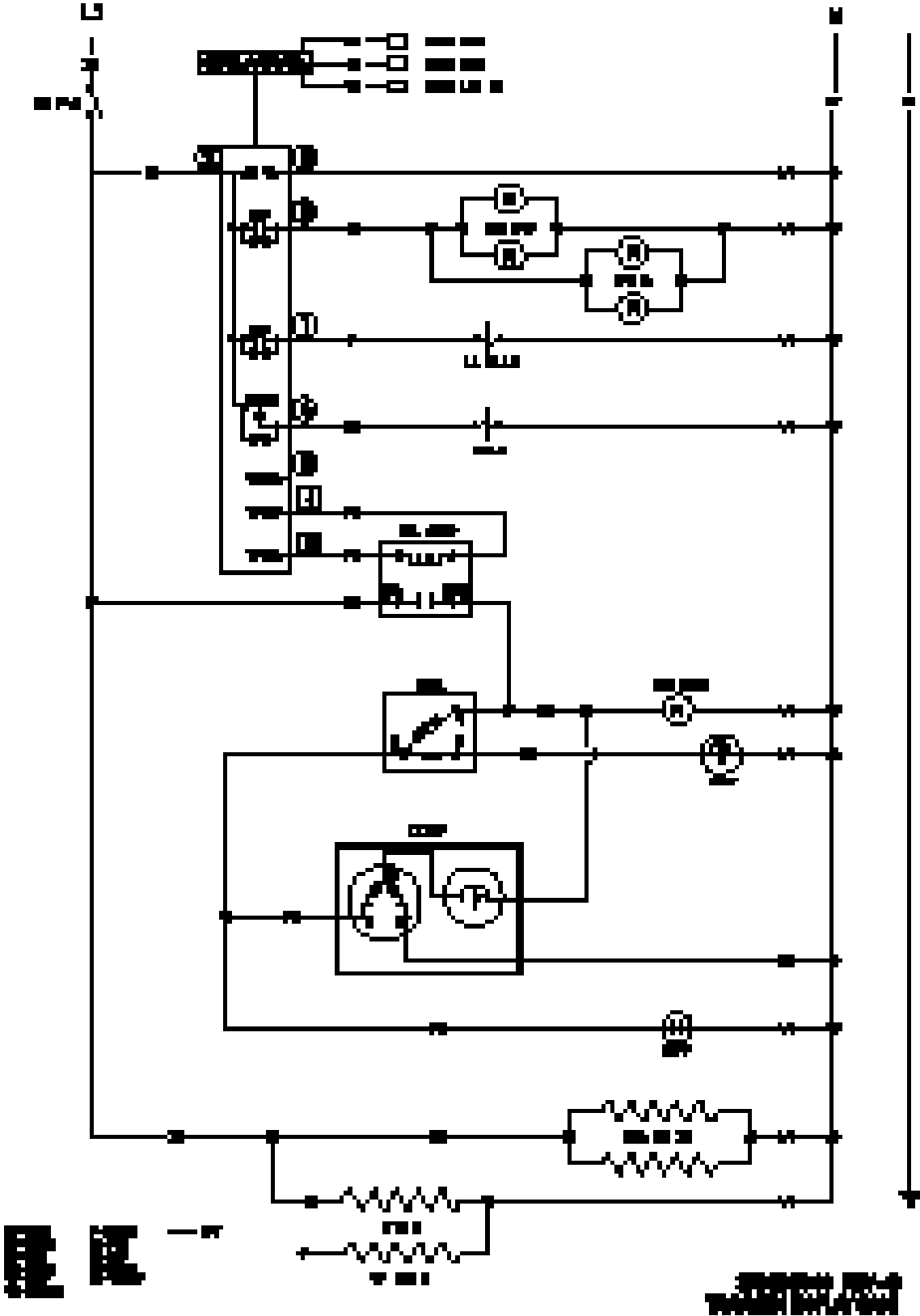

**HOURS OF OPERATION:**

Monday thru Friday 7:30 am - 4:30 pm CST



**Quality Refrigeration**

4401 Blue Mound Road Fort Worth, TX 76106  
Phone: (800) 825-8220 Fax-Svce: (817) 740-6757  
traulsen.com

© 2015 Traulsen - All Rights Reserved