

REFRIGERATOR MANUFACTURER
Turbo air

Turbo Air Speed up the Pace of Innovation

CAUTION!
PLEASE KEEP POWER
SWITCH ON BEFORE
OPERATING THIS EQUIPMENT

Display Cases Deli Cases Installation and Operation Manual

Please read this manual completely before attempting to install or operate this equipment!

REFRIGERATED CASE

TD-4R

TD-5R



CONTENTS

	PAGE
SPECIFICATION	2
INSTALLATION	3
PACKAGING MATERIAL	4
LIGHTS	4
SHELVES	4
ELECTRICAL INFORMATION	5
WIRING DIAGRAM	6-7
OPERATING INSTRUCTIONS	8-9
FRONT CURVED GLASS	10
MAINTENANCE & CLEANING	11-12
TROUBLE SHOOTING	13
WARRANTY	14-16

SPECIFICATIONS

MODEL	COMP H.P	V/Hz	REFRIGERANT	AMPS	WEIGHT
TD-4R	1/2	115V/60Hz	R-134A	17.2	588
TD-5R	1/2	115V/60Hz	R-134A	17.2	697

INSTALLATION

INSPECTION FOR DAMAGE

Customer is responsible for checking for damage. First inspect crate as soon as it arrives. Prior to signing if crate is damaged make sure you note that on bill of lading.

If after uncrating there is concealed damage and crate was in good condition you must call Customer Service at Turbo Air. Concealed damage must be reported within 24 hours of receiving unit. Bill of lading will be requested faxed to claim department. Pictures may be requested of unit and crating.

LOCATION OF DELI CASE

Installation Clearance :

86 inch at the top, 20 inch at the rear and 12 inch at the cash inside.

CAUTION : Damage to case and glass can result if pushed on. Do not push curved glass, end glass, doors or door frames.

Do not place Deli Case in the following locations ; near source of heat, excessive air movement, open doors, and direct sunlight.

Move the Deli Case to the final location before removing shipping skid.

Condenser is in back of Deli Case. Do not block inlet.

LEVELING OF DELI CASE

Four leveling legs are provided for leveling Deli Case.

Use a leveler to make sure unit is leveled on all four corners.

If unit is not leveled drainage of water will not drain properly and doors will not close properly. Leveling legs can be adjusted accordingly.

PACKAGING MATERIAL

Remove all tape that holds life up glass and doors in place. Some residue will be left and this can be removed with glass cleaner.

Remove all plastic ties that hold shelves and brackets for shelves.

LIGHTS

Make sure lights are in their lamp holders. Also make sure plugs for lamp holders are completely plugged in. If they are loose it may cause lamp holder to burn.

SHELVES

To install shelves in desired position front glass must be open and rear doors removed.

Where shelf height is desired install the shelf support in shelf standard slot (see drawing).



Install shelves on rear shelf support as shown. Curved part of shelf must be toward rear of case if not air flow will be blocked. Snap shelf into retainer clip on the shelf support, this keeps shel from moving (see drawing).

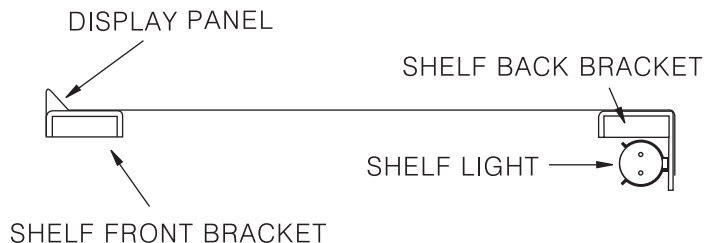

ELECTRICAL INFORMATION

DELI CASE MUST BE GROUNDED

Only a licensed electrician must install all electrical on Deli Case.

All electrical must be done in accordance with applicable electrical standards.

A dedicated breaker is to be used for each Deli Case.

Electrical must be grounded upon installation

An access hole is provided thru base of case for running electrical up through floor. Also a hole is provided in the back of unit to run electrical. Unit is designed to be hardwired by electrician. Electrical data is located next to electrical junction box. (see drawing)

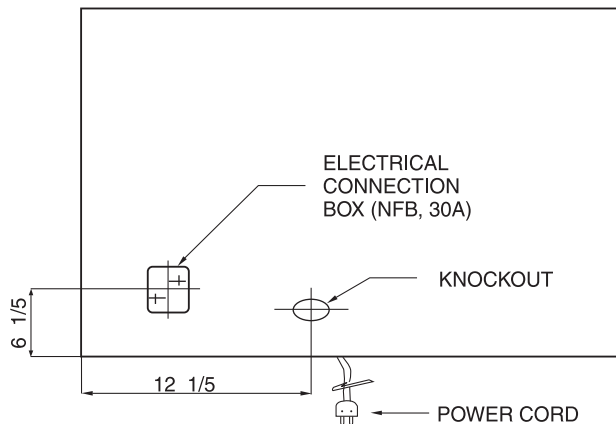

The Deli Case comes with a power cord. Cord is 9.8 feet long. The plug is a _____.

***Improper electrical connections can result in severe injury or death.
Do not operate Deli Case with panels or grill removed.***

There are two back panels.

Right side panel has light switch, power switch, thermostat, and thermometer. Also compressor service ports, electrical condensate drain pan, fuses, and main board are accessible.

Left side panel allows access to electrical connection box, ballast, and also allows condenser unit to be pulled out.

Front panel is removable to have access to fans.

WIRING DIAGRAM (TD-4R, TD-5R)

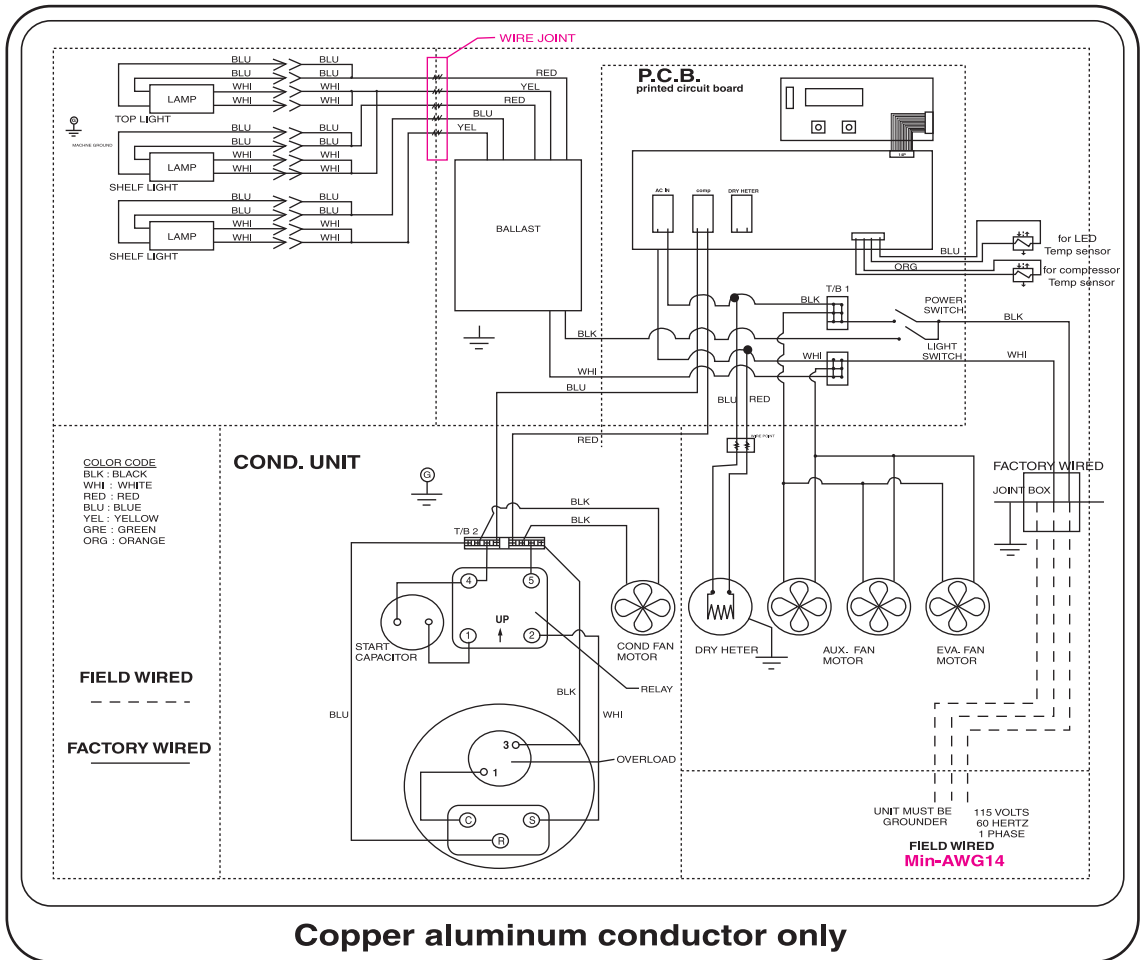

Copper aluminum conductor only

WIRING DIAGRAM (TD-4, TD-5)

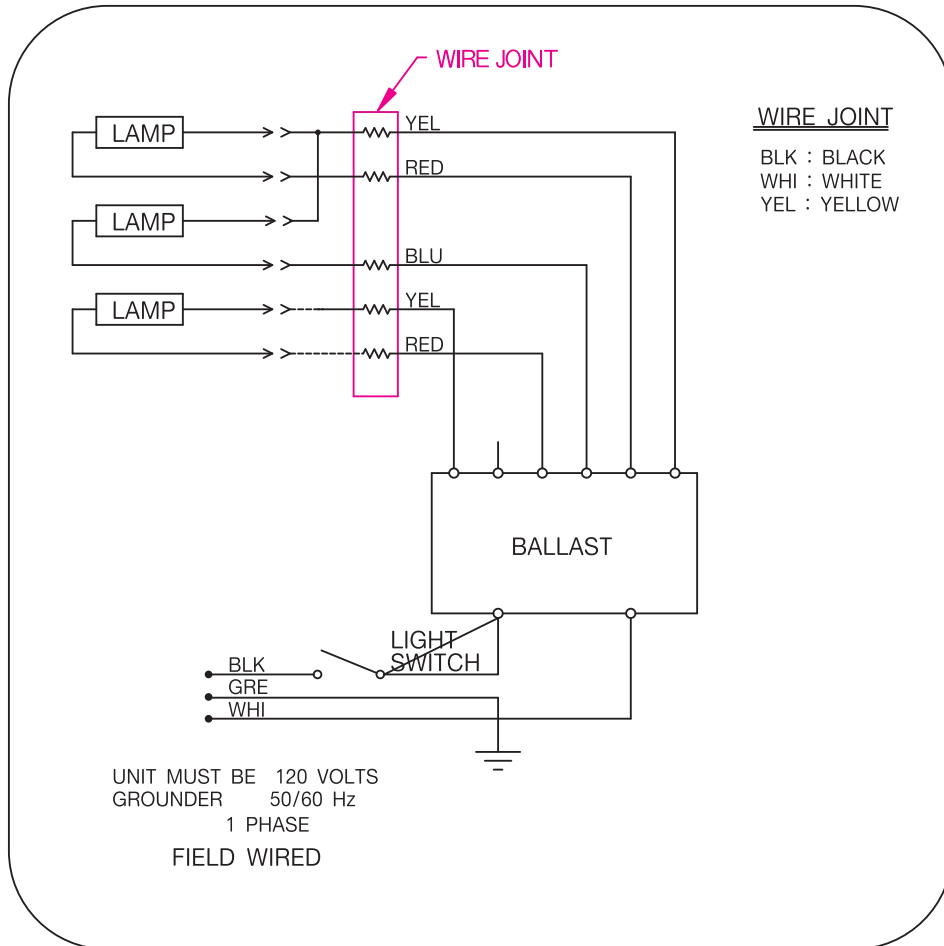

OPERATING INSTRUCTIONS

After installing unit and all electrical to Bakery Case, unit is ready to start up.

CONTROLS

POWER SWITCH : It is labeled with on/off position. It controls power to the entire Bakery Case.

LIGHT SWITCH : The switch controls the power to the lighting circuit. The switch rocker is red in the “on” position, black in the “off” position.

TEMPERATURE CONTROL :

TB-4R

TB-5R

1. The controller(thermostat) is located at the right inside of the unit.
2. The factory setting for the control is Normal.
3. To lower temperature, depress down button to increase temperature, depress up button.
4. This product is for controlling temperature from 38°F to 55°F.

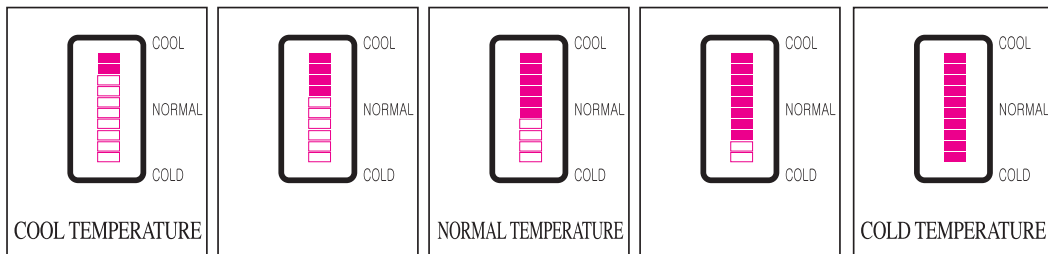

5. The thermostat controls compressor’s on/off by sensing inside temperature.

THERMOMETER : Display changes temperature approximately every two second.

NOTE :

Before placing goods to Bakery Case wait for unit to reach desired temperature.
Product must be cold before placing in Bakery Case.

ANTI MOISTURE FANS : These fans run continuously when power switch is on. Two fans are at the front bottom of unit. The fans blew warm air through vents and prevent front glass from getting moisture. Do not block vents because front glass will get moisture.

HOW TO PLACE PRODUCT : Check that display pans are positioned correctly before placing goods in Bakery Case (see drawing). Do not overstock shelves. Display pans should not hang over shelf. This will cause pan to block air flow and Bakery Case will warm up in temperature. This will cause product to spoil.

OPERATING INSTRUCTIONS

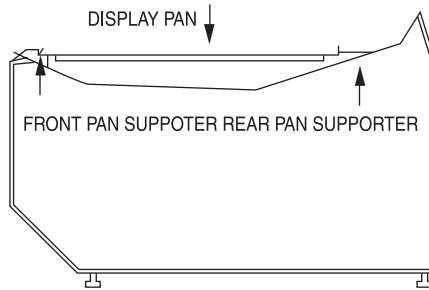

SHELF PLACEMENT :

The shelves can be installed slanted or straight. To make the shelf slanted do the following.

- Shelf needs to be removed from shelf support.
- Shelf support needs to be held at each end.
- Shelf support needs to be lifted at the back till bracket can be inserted into self standard slots.

Refer to drawing of page 4.

ADJUSTING SHELF LEVEL

Shelves can be adjusted up or down. To move shelves do the following ;

- Lights must be turned off.
- Grasp plug for light cord and unplug.
- Shelves must be removed from shelf support.
- Hold onto each end of shelf support.
- Shelf support needs to be moved up until it can be removed from shelf standard.

REPLACEMENT OF LIGHT

When replacing lights use same model of light installed in Bakery Case. Using wrong wattage can cause ballast to burn out or light not work.

To remove light there is two lamp holders one at each end of light. One has a spring in socket. Push light toward spring loaded lamp holder till other end of light pops out of other lamp holder.

Remove light from lamp shield and insert new light into lamp shield. Reinsert into lamp holders. Never install lamp without shield.

FRONT CURVED GLASS

WARNING

The Bakery Case is not intended for self serve. Do not let customers lift front glass. Only trained personnel should lift curved glass.

Under normal use hinges will last many years. If any of the following problems occur, please call Customer Service ;

- a. Front curved glass closed rapidly.
- b. Front curved glass does not open easily.
- c. Front curved glass does not stay open, when in the opened position.

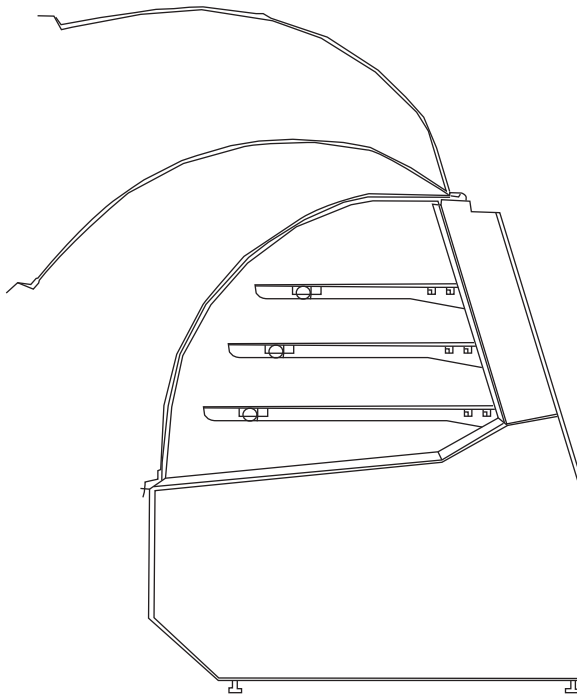

MAINTENANCE & CLEANING

Always before cleaning Bakery Case unit should be turned off at power switch and lights should be turned off. Removed product and allow display to reach room temperature.

Do not wet electrical components.

BAKERY CASE SHOULD BE CLEANED THOROUGHLY BEFORE FIRST USE.

CLEANING DAILY

1. Do not clean with harsh detergents. Use a mild soap.
2. If door track is dirty remove doors. Keeping door track clean allows for doors to slide easily. Food silicone can be sprayed on roller and track.
3. Clean glass with window cleaner.
4. Exterior and interior can be cleaned with water and mild detergent.

CLEANING WEEKLY

This procedure is necessary to keep a sanitized Bakery Case. Procedure may have to be done more than once a week if necessary.

EXTERIOR CLEANING

1. Clean front glass with window cleaner.
2. Clean exterior with warm soapy water. Wipe down with damp cloth.

INTERIOR CLEANING

1. Remove both doors by lifting up and out.
2. Raise front curved glass all the way up.
3. Grasp plug for light cord and unplug.
4. Remove shelves.
5. Remove shelf support from shelf standard slots.
6. Remove both thumb screws holding shelf standard and removed shelf standards.
7. Remove display pans.
8. Wash all parts with warm soapy water and rinse. Allow to dry.
9. Clean inside of unit with warm soapy water.
Wipe down with damp cloth. Allow to dry.
10. Put unit back together in reverse order starting with step.

MAINTENANCE & CLEANING

CONDENSER COIL

1. Turn off unit at power switch. Disconnect power to unit.
2. Remove rear grill.
3. Clean condenser by either brushing off with stiff wire brush or vacuuming with wet/dry vacuum. Condenser is black and looks like a radiator. This should be cleaned every month or as necessary. Keeping clean allows for maximum cooling of unit and long life of compressor.

Load Line

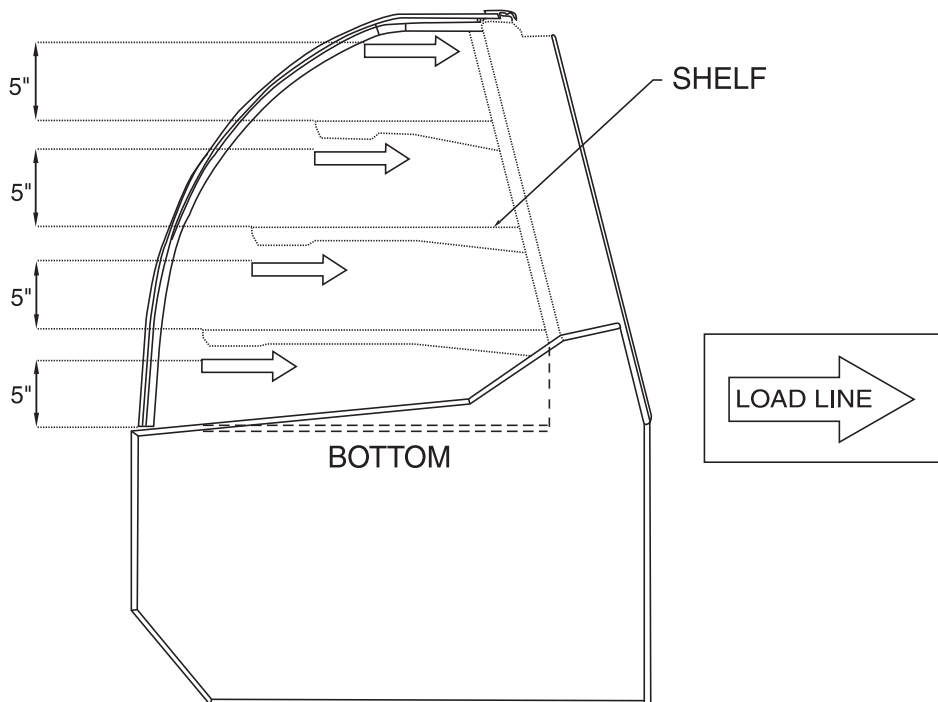

SIDE DRAW

“If food is placed above the load. It will not be adequately refrigerated.
Please do not load food above load line.”

TROUBLE SHOOTING

For any problems with Deli Case please refer to following check list. If still having a problem or need to ask a question please call Customer Service at 1-800-381-7770 or 1-800-627-0032

DELI CASE NOT WORKING

1. Check to see if breaker is not tripped.
2. Check power going to unit.
3. Check thermostat is set at on position.
4. Check power switch is on.

DELI CASE WARM

1. Check condenser to see if clean.
2. Check that doors and curved glass are closed tightly.
3. Check that shelves are installed properly.
4. Check that air flow inside of unit is not blocked with product or pans.

GLASS SWEATING

1. Check that there is nothing on top of curved glass.
2. Check to see that there are no overhead vents, air ducts or fans.
3. Check temperature of room. Deli Case is designed to operate in an ambient temperature of 75 degrees Fahrenheit and 55% relative humidity.
4. Check temperature of Deli Case. Unit should be between 38 and 42 degrees.
5. Check that air is flowing inside front of Deli Case. If there is no air flow or air is felt on only one side this is due to anti moisture fans are not working. Customer Service needs to be called.

LIGHTS NOT WORKING

1. Check that light switch is on.
2. Check that lamp cord is plugged in correctly.
3. Check that light is in lamp holder correctly.

TWO YEAR WARRANTY

Turbo air warrants to the original purchaser of every new Turbo air refrigerated unit, the cabinet and all parts thereof, to be free from defects in material or workmanship, under normal use and service, for a period of two (2) year from the date of original installation or 27 months after shipment date from Turbo air , whichever occurs first.

Any parts covered by this warranty that are examined and determined by Turbo air to have been defective within two (2) year of original installation or twenty seven (27) months after shipment date from manufacturer, whichever occurs first, shall be repaired or replaced as stated below. Turbo air shall be deemed to have fully complied with its obligation under the foregoing warranties by electing either one of the following procedures, at the sole discretion of Turbo air.

1. Furnishing a replacement part, freight collect, in even exchange for the returned part, freight collect.
2. Receiving the defective part, freight collect; repairing it; and returning it, freight collect.

ADDITIONAL THREE YEAR COMPRESSOR WARRANTY

In addition to the (2) two year warranty stated above, Turbo air warrants its hermetically and semi-hermetically sealed compressor to be free from defects in both material and workmanship under normal use and service for a period of three (3) additional years from the date of original installation but not to exceed five (5) years and three (3) months after shipment from manufacturer.

Compressors determined by Turbo air have been defective within this extended time period will, at Turbo air's option, be either repaired or replaced with a compressor or compressor parts of similar design and capacity.

The three (3) year extended compressor warranty applies only to hermetically and semi-hermetically sealed parts of the compressor and does not apply to any other parts or components, including, but not limited to, cabinet, paint finish, temperature control, refrigerant, metering device, driers, motor starting equipment, fan assembly any other electrical component, etcetera.

134A(404A) COMPRESSOR WARRANTY

The five year compressor warranty detailed above will be voided if the following procedure is not carefully adhered to:

1. This system contains R134A refrigerant and polyol ester lubricant. The Polyol ester lubricant has rapid moisture absorbing qualities. If long exposure to the ambient conditions occur, the lubricant must be removed and replaced with new. Listed below are the approved lubricants for the Tecumseh compressors.

- 1 ICI-Emkarate RL 184
- 2 Emery-2927-A
- 3 Mobile Artic 22A

Failure to comply with recommended lubricant specification will void the compressor warranty.

2. Dryer replacement is very important and must be changed when a system is opened for servicing. dryer must be used with XH-9 desiccant.
3. Micron level vacuums must be achieved to insure low moisture levels in the system. 500 microns or lower must obtained.

What is NOT covered by this warranty

Turbo air's sole obligation under this warranty is limited to either repair or replacement of parts, subject to the additional limitations below. This warranty neither assumes nor authorizes any person to assume obligations other than expressly covered by this warranty.

1. **WARRANTY IS NOT TRANSFERABLE.** This warranty is not assignable and applies only in favor of the original purchaser/user to whom delivered. ANY SUCH ASSIGNMENT OR TRANSFER SHALL VOID THE WARRANTIES HEREIN MADE AND SHALL VOID ALL WARRANTIES, EXPRESS OR IMPLIED, INCLUDING ANY WARRANTY OF MERCHANTABILITY OR FITNESS FOR A PARTICULAR PURPOSE.
2. **NO CONSEQUENTIAL DAMAGES.** TURBO AIR IS NOT RESPONSIBLE FOR ECONOMIC LOSS; PROFIT LOSS OR SPECIAL, INDIRECT, OR CONSEQUENTIAL DAMAGES, INCLUDING WITHOUT LIMITATION, LOSSES OR DAMAGES ARISING FROM FOOD OR PRODUCT SPOilage CLAIMS WHETHER OR NOT ON ACCOUNT OF REFRIGERATION FAILURE.
3. **ALTERATION, NEGLIGENCE, ABUSE, MISUSE, ACCIDENT, DAMAGE DURING TRANSIT OR INSTALLATION, FIRE, FLOOD, ACTS OF GOD.** TURBO AIR is not responsible for the repair or replacement of any parts that Turbo Air determines have been subjected after the date of manufacture to alteration, neglect, abuse, misuse, accident, damage during transit or installation, fire, flood, or an Act of God.
4. **NO IMPLIED WARRANTY OF MERCHANTABILITY OR FITNESS FOR A PARTICULAR PURPOSE.** THERE ARE NO OTHER WARRANTIES, EXPRESS, IMPLIED OR STATUTORY, EXCEPT THE TWO(2) YEAR WARRANTY AND THE ADDITIONAL THREE (3) YEAR COMPRESSOR WARRANTY AS DESCRIBED ABOVE. THESE WARRANTIES ARE EXCLUSIVE AND IN LIEU OF ALL OTHER WARRANTIES, INCLUDING IMPLIED WARRANTY AND MERCHANTABILITY OR FITNESS FOR A PARTICULAR PURPOSE. THERE ARE NO WARRANTIES WHICH EXTEND BEYOND THE DESCRIPTION ON THE FACE HEREOF.
5. **TRANSPORTATION COSTS.** Turbo Air will accept parts covered under this warranty freight collect, provided that shipment has received prior approval. Turbo Air is not responsible for any other transportation costs, but will ship freight collect parts either repaired or replaced under these warranties.
6. **WARRANTY CLAIMS.** All claims should include: model number of the cooler, the serial number of the cabinet, proof of purchase, date of installation, and all pertinent information supporting the existence of the alleged defect. Any action or breach of these warranty provisions must be commenced within two (2) year after that cause of action has accrued.

Turbo air REFRIGERATOR MANUFACTURER

4184 E. Conant St.
Long Beach, CA 90808
TEL : 310-900-1000
FAX : 310-900-1077
TOLL FREE : 1-800-627-0032
(U.S.A. & Canada)
Website : www.turboairinc.com

Warranty Claims...

All claims for parts or labor must be made directly through Turbo Air.

All claims should include: model number of the unit, the serial number of the cabinet, proof of purchase, date of installation, and all pertinent information supporting the alleged defect.

In case of compressor replacement under warranty, either compressor or compressor tag must be returned to Turbo Air along with above listed information.

Failure to comply with warranty policies will result in voiding claims.

Two Year Parts & Labor Warranty...

Turbo Air warrants all new refrigerated components, the cabinet and all parts, to be free from defects in materials or workmanship, under normal and proper use and maintenance service as specified by Turbo Air and upon proper installation and start-up in accordance with the instruction packet supplied with each Turbo air unit. Turbo Air's obligation under this warranty is limited to a period of two (2) year from the date of original installation or 27 months after shipment date from Turbo Air, whichever occurs first.

Any part, covered under this warranty, that are by Turbo Air to have been defective within two (2) year of original installation or twenty seven (27) months after shipment date from manufacturer, whichever occurs first, is limited to the repair or replacement, including labor charges, of defective parts or assemblies. The labor warranty shall include standard straight time labor charges only and reasonable travel time, as determined by Turbo Air.

Additional Three Year Compressor Warranty...

In addition to the two (2) year warranty stated above, Turbo Air warrants its hermetically sealed compressor to be free from defects in both material and workmanship under normal and proper use and maintenance service for a period of three (3) additional years from the date of original installation, but not to exceed five (5) years and three(3) months after shipment from the manufacturer.

Compressor determined by Turbo Air to have been defective within this extended period will, at Turbo Air's discretion, be either repaired or replaced with a compressor or compressor parts of similar design and capacity.

The three (3) year extended compressor warranty applies only to hermetically sealed parts of the compressor and does not apply to any other parts or components, including, but not limited to, cabinet, paint finish, temperature control, refrigerant, metering device, driers, motor starting equipment, fan assembly or and other electrical components, etcetera.

404A / 134a Compressor Warranty...

The five-year compressor warranty detailed above will be void if the following procedure is not carefully adhered to:

1. This system contains R404A or R134a refrigerant and polyol ester lubricant. The polyol ester lubricant has rapid moisture absorbing qualities.
2. Drier replacement is very important and must be changed when a system is opened for servicing. A620 copper drier or better is highly recommended.
3. Micron level vacuums must be achieved to insure low moisture levels in the system. 500 microns or lower must be obtained.
4. When compressor is grounded, suction drier and 620 drier or better must be replaced.
5. Compressor must be obtained through Turbo Air, unless otherwise specified in writing, through Turbo Air's warranty department.

404A / 134a Compressor Warranty...

Turbo Air's sole obligation under this warranty is limited to either repair or replacement of parts, subject to the additional limitations below. This warranty neither assumes nor authorizes any person to assume obligations other than those expressly covered by this warranty.

NO CONSEQUENTIAL DAMAGES. TURBO AIR IS NOT RESPONSIBLE FOR ECONOMIC LOSS; PROFIT LOSS; OR SPECIAL, INDIRECT, OR CONSEQUENTIAL DAMAGES, INCLUDING WITHOUT LIMITATION, LOSSES, OR DAMAGES ARISING FROM FOOD OR PRODUCT SPOILAGE REGARDLESS OF WHETHER OR NOT THEY RESULT FROM REFRIGERATION FAILURE.

WARRANTY IS NOT TRANSFERABLE, This warranty is not assignable and applies only in favor of the original purchaser/user to whom delivered. ANY SUCH ASSIGNMENT OR TRANSFER SHALL VOID THE WARRANTIES HEREIN AND SHALL VOID ALL WARRANTIES, EXPRESS OR IMPLIED, INCLUDING ANY WARRANTY OF MERCHANTABILITY OR LABOR COVERAGE FOR COMPONENT FAILURE OR OTHER THE WARRANTY PACKET PROVIDED WITH THE UNIT.

ALTERATION, NEGLIGENCE, ABUSE, MISUSE, ACCIDENT, DAMAGE DURING TRANSIT OR INSTALLATION, FIRE, FLOOD, ACTS OF GOD. Turbo Air is not responsible for the repair or replacement of any parts that Turbo Air determines have been subjected after the date of manufacture to alteration, neglect, abuse, misuse, accident, damage during transit or installation, fire, flood, or act of GOD.

IMPROPER ELECTRICAL CONNECTIONS. TURBO AIR IS NOT RESPONSIBLE FOR THE REPAIR OR REPLACEMENT OF FAILED OR DAMAGED COMPONENTS RESULTING FROM ELECTRICAL POWER FAILURE, THE USE OF EXTENSION CORDS, LOW VOLTAGE, OR VOLTAGE DROPS TO THE UNIT. NO IMPLIED WARRANTY OF MERCHANTABILITY OR FITNESS FOR A PARTICULAR PURPOSE; THERE ARE NO OTHER WARRANTIES, EXPRESSED, IMPLIED OR STATUTORY, EXCEPT THE TWO (2) YEAR PARTS & LABOR WARRANTY AND THE ADDITIONAL THREE (3) YEAR COMPRESSOR WARRANTY AS DESCRIBED ABOVE. THESE WARRANTIES ARE EXCLUSIVE AND IN LIEU OF ALL OTHER WARRANTIES, INCLUDING IMPLIED WARRANTY AND MERCHANTABILITY OR FITNESS FOR A PARTICULAR PURPOSE. THERE ARE NO WARRANTIES, WHICH EXTEND BEYOND THE DESCRIPTION ON THE FACE HEREOF.

Outside U.S. and Canada; This warranty does not apply to, and Turbo Air is not responsible for, any warranty claims made on products sold or used outside the continent of the United States and Canada.