



TOWN

Town Food Service Equipment Co., Inc. logo in Chinese characters: 豐公司

FOOD SERVICE EQUIPMENT CO., INC.

72 Beadel Street Brooklyn, NY 11222

718/ 388-5650 outside New York State 800/ 221-5032 facsimile 718/ 388-5860
www.townfood.com



RiceMaster



Automatic Gas Rice Cooker Owner's Manual

RM-55N-R (NATURAL GAS) | RM-55P-R (PROPANE GAS) NSF AND ETL CERTIFIED

RM-50N-R (NATURAL GAS) | RM-50P-R (PROPANE GAS) NOT CERTIFIED

SECTION 1 INSTALLATION INSTRUCTIONS

FOR COMMERCIAL USE ONLY

Warning

Improper installation, adjustment, alteration, service or maintenance can cause property damage, injury or death.

Read the installation, operating and maintenance instructions thoroughly before installing or servicing this equipment.

For Your Safety

Do not store or use gasoline or other flammable vapors and liquids in the vicinity of this or any other appliance.

Important

Contact your local gas supplier if you smell gas near this equipment.

**DO NOT DISCARD INSTRUCTIONS. THIS MANUAL MUST REMAIN WITH THE UNIT FOR FUTURE REFERENCE.
THIS EMERGENCY INFORMATION MUST BE PROMINENTLY DISPLAYED.**

Congratulations on your purchase of your RiceMaster Automatic Gas Rice Cooker.

With proper installation, care and use, it should provide years of reliable service.

IMPORTANT NOTE

The [RM-50N-R](#) or RM-50-P-R is not NSF or ETL certified. However, its functionality and most of the specifications are identical to the [RM-55N-R](#) and RM55P-R. Most [RM-50N-R](#) and RM-50-P-R parts are interchangeable with [RM-55N-R](#) and [RM-55P-R](#). Except for listings and certification, information in this manual for the [RM-50N-R](#) and RM-50-P-R is the same as the [RM-55N-R](#) and RM-55-P-R.

PARTS IDENTIFICATION

BURNER ASSEMBLY

- 1** shut off stem
- 2** burner base cover
- 3** pilot/warmer
- 4** main burner
- 5** data plate
- 6** no.1 start button/ignition lever
- 7** no.2 main burner/cook button
- 8** main gas valve knob
- 9** pilot ignition button-red

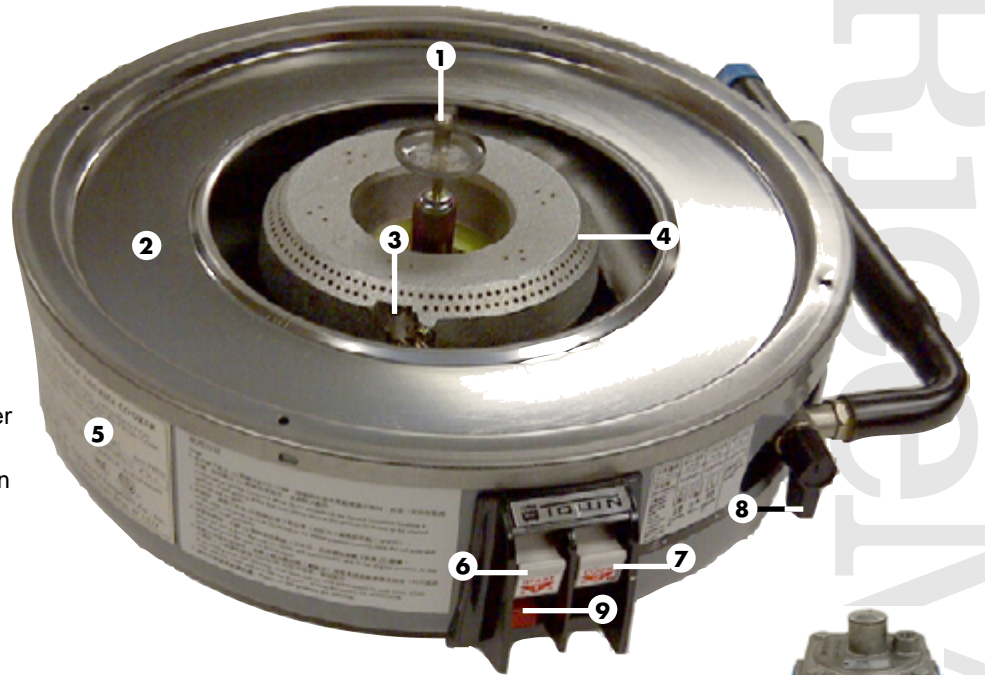

lid



rice pot



pressure regulator



outer jacket



jacket window

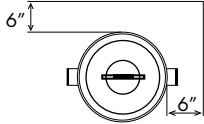

INSTALLATION INSTRUCTIONS

- 1) The gas supply line must be of adequate size to ensure maximum efficiency of the unit.
- 2) The installation must conform with the National Fuel Gas Code, ANSI Z223.1, Natural Gas Installation Code, CAN/CGA-B149.1 or the Propane Installation Code, CAN/CGA-B149.2, as applicable including:
 - a) The appliance and it's individual shut-off valve must be disconnected from the gas supply piping system during any pressure testing of that system at test pressure in excess of ½ psig (3.45 kPa).
 - b) The appliance must be isolated from the gas supply piping system by closing it's individual manual valve during any pressure testing of the gas supply piping system at test pressures equal or less than ½ psig (3.45 kPa).
- 3) Local regulations governing gas appliance installations must be complied with.
- 4) Equipment should be in an area with adequate ventilation.
- 5) Minimum spacing of 6" to combustible construction is required along back and side walls. Clearance for noncombustible construction are the same as combustible clearances. For use only on noncombustible surfaces.
 
- 6) Materials such as wood, compressed paper and plant fibers that will ignite and burn, **must not be exposed near the unit**. Local safety codes should be complied with in respect to fire hazard avoidance.
- 7) **Use of the supplied pressure regulator is mandatory.** Note that the use of 2 regulators may cause insufficient gas flow. Consult with installer but always comply with above codes.
- 8) Keep the appliance area free and clear from combustible materials, gasoline and other flammable vapors and liquids.
- 9) Locate this appliance in a well ventilated area. **Do not block or cover the opening between the shroud and pot. Do not obstruct flow of combustion and ventilation air.**
- 10) The unit must be installed with adequate clearance for servicing and proper operation.
- 11) If the unit is connected to a flexible gas line, the installation must be made with a connector that complies with the Standard Connectors for Movable Gas Appliances, ANSIZ21.69 or Connectors for Movable Gas Appliances, CAN/CGA-06.16, and a Quick Disconnect device that complies with the standard for Quick Disconnect Devices for Use with Gas Fuel ANSIZ21.41, or Quick Disconnect Devices for use with Gas Fuel, CAN1-6.9, and adequate means must be provided to limit the movement of the appliance without depending on connector and the Quick Disconnect device or it's associated piping to limit movement of the appliance.
- 12) Before connecting gas check that gas valve is turned **OFF** (gas valve handle in the vertical position).
- 13) Check for leaks using soapy water or other suitable leak detector. Rinse off the soapy water after testing. **Do not use open flame for testing.**

LIGHTING AND SHUT DOWN INSTRUCTIONS

Always follow these lighting and shut down instructions when lighting rice cooker. A 5 minute complete shutoff period is required before lighting or relighting pilot. Check for gas leaks before relighting unit. Use soapy water or other suitable leak detector. Rinse off the soapy water after testing.

Notice to Installer—the following must be performed to insure proper operation

- 1) Remove pot, outer jacket, and base cover.
- 2) Turn gas valve to **ON** position as shown in figure 2 below.
- 3) Gently push on the **#2 COOK** button. It should stop half way down and not engage. This is a safety feature feature that does not allow accidental start of the main burner unless the pilot button has already been pushed.
- 4) Push the left button marked **#1 START** down until the unit clicks, then release it. This is the ignition lever and should light the pilot. The red button labeled **WARM** button controls the pilot and is hidden by the **#1 START** button when off. Pushing the **#1 START** button also engages the **WARM** button and exposes it. It will stay down until pushed up to extinguish the pilot. If the pilot has not lit, repeat until the pilot lights.
- 5) If pilot fails to remain lit, refer to **TROUBLE SHOOTING** on page 14.
- 6) Replace the pot, outer jacket, and base cover in their proper order. With the pilot lit, push the **#2 COOK** button down to its position without water in the pot. The unit should shut off within 3 to 4 minutes. If it fails to shut off, push the **#2 COOK** button up to the **OFF** position and see **TROUBLE SHOOTING** on page 14. If it shuts off normally, add a gallon of water and wait for the click indicating that the sensor has reset. With the pilot lit, press the **#2 COOK** button again. The rice cooker should boil the pot dry and then shut off. If it fails to shut off normally, press the **#2 COOK** button up to it's **OFF** position and refer to the **TROUBLE SHOOTING** section on page 14 for additional causes and remedies.

WARNING

When igniting the pilot, position the jacket window directly over **#1 START** and **#2 COOK** buttons. Use caution when igniting pilot and maintain a safe distance from jacket window (figure 3).

SHUT DOWN

When removing the pot, make sure to push the red **WARM** button up until it clicks and is hidden by the **#1 START** button—it is then in the **OFF** position. A 5 minute complete shut off period is required before lighting or relighting pilot.

figure 1

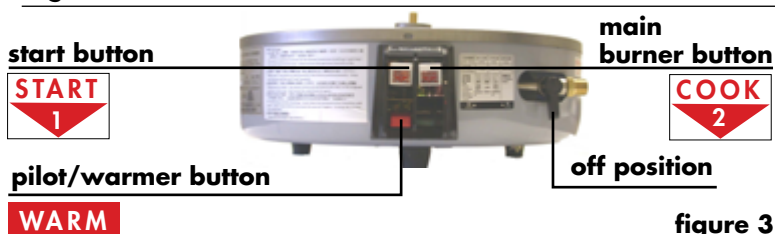

figure 2



figure 3



SPECIFICATIONS, DIMENSIONS, AND GAS INPUT INFORMATION

	RM-50/55N-R	RM-50/55P-R
type of gas	natural	propane
BTU	34,600	27,300
gas connection	3/4" NPT	3/4" NPT
liquid capacity	24 qts.	24 qts.
unit size	22" (depth) x 17" (height)	22" (depth) x 17" (height)
net weight	43 lbs.	43 lbs.
carton size	21" x 21" x 18"	21" x 21" x 18"
master carton	1 unit (4.4 cu. ft.)	1 unit (4.4 cu. ft.)
shipping weight	46 lbs.	46 lbs.
color	RM-50N: red base, RM-55N: gray base	RM-50P: red base RM-55P: gray base
capacity	raw rice: 18 lbs. (55 6 oz. cups*) cooked rice: 43 lbs. (110 6 oz. cups*)	raw rice: 18 lbs. (55 6 oz. cups*) cooked rice: 43 lbs. (110 6 oz. cups*)

*Asian standard measurement of 6 oz., opposed to an 8oz. cup

PARTS LIST

for parts breakdown, see page 6

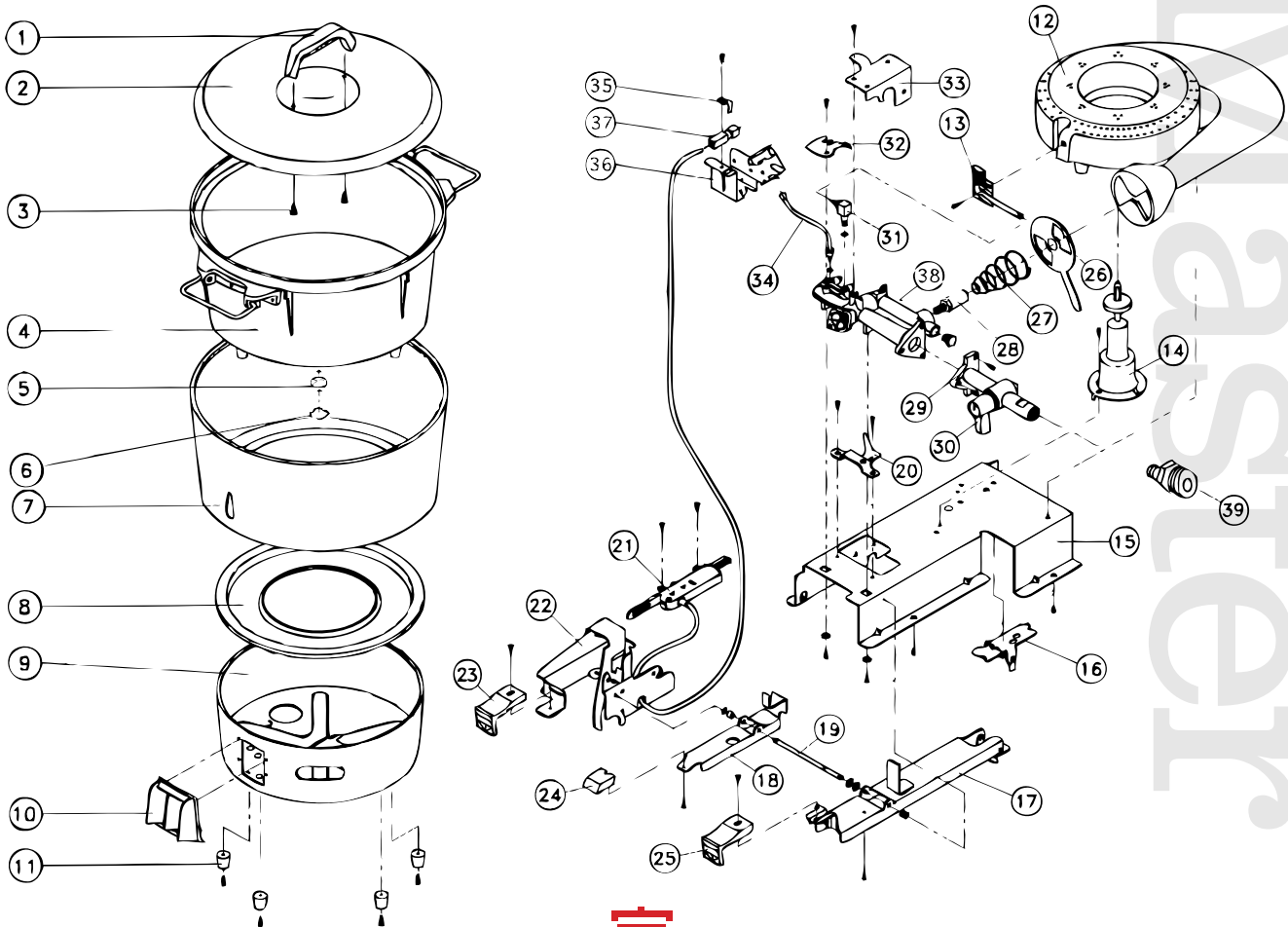

PARTS LIST



NUMBER	PART NUMBER	DESCRIPTION
1	56881	cover handle, heat resistant
2	56882	stainless steel rice pot cover with handle
3	56881-S	cover handle screw
4	56853	cast iron aluminum rice pot
5	56855	encased sensing element, bimetalic
6	56856	sensing element retaining spring
5/6	56854	sensing element kit
7	56884	outer jacket for RM-50
7	56884A	outer jacket for RM-55
8	56885A	RM-55 stainless steel base cover (56885 for RM-50)
9	56852-1	lower body for RM-50 (red)
9	56852-1A	lower body for RM-55 (grey)
10	56866	control panel frame
11	56863	non-mar feet
12	56852-2	cast iron burner
13	56878	pilot with retaining plate
14	56857	shut off stem assembly
15	56852-3	burner assembly base
16	56857-1	burner ignition arm release
17	56867	burner ignition arm
18	56864-1	pilot ignition arm
19	56864-2	ignition arm shaft
20	56862-2	burner ignition arm limiter
21	56870	piezo ignition assembly
22	56870-1	ignition lever assembly
23	56865	no.1 start button
24	56864	red pilot warmer button
25	56862	no.2 main burner button
26	56852-4	air shutter
27	56852-4S	air shutter spring
28	56868	main burner orifice, natural gas (.475mm/#77 drill)
28	56869	main burner orifice, propane gas (.343mm/#80 drill)
29	56860	on/off gas valve
30	56861	gas valve knob
31	56879	pilot orifice, natural gas
31	56880	pilot orifice, propane gas
32	56874-1	ignition line retaining plate
33	56872	pilot orifice retaining plate
34	56874	pilot ignition line, natural gas
34	56873	pilot ignition line, propane gas
35	56871-1	ceramic electrode clamp
36	56870-2	ceramic electrode holder
37	56871	ceramic electrode
38	56875	manifold assembly, natural gas
38	56876	manifold assembly, propane gas
	RM-55N-REG	3/4" pressure regulator, natural gas
	RM-55P-REG	3/4" pressure regulator, propane gas
39	56861-B	brass connecting fitting (older models)

RiceMaster





TOWN

公司
富
隆

FOOD SERVICE EQUIPMENT CO., INC.

72 Beadel Street Brooklyn, NY 11222

718/388-5650 outside New York State 800/221-5032 facsimile 718/388-5860

www.townfood.com



RiceMaster



Automatic Gas Rice Cooker Owner's Manual

RM-55N-R (NATURAL GAS) | RM-55P-R (PROPANE GAS) NSF AND ETL CERTIFIED

RM-50N-R (NATURAL GAS) | RM-50P-R (PROPANE GAS) NOT CERTIFIED

SECTION 2 OPERATING AND MAINTENANCE INSTRUCTIONS

FOR COMMERCIAL USE ONLY

Warning

Improper installation, adjustment, alteration, service or maintenance can cause property damage, injury or death.

Read the installation, operating and maintenance instructions thoroughly before installing or servicing this equipment.

For Your Safety

Do not store or use gasoline or other flammable vapors and liquids in the vicinity of this or any other appliance.

Important

Contact your local gas supplier if you smell gas near this equipment.

**DO NOT DISCARD INSTRUCTIONS. THIS MANUAL MUST REMAIN WITH THE UNIT FOR FUTURE REFERENCE.
THIS EMERGENCY INFORMATION MUST BE PROMINENTLY DISPLAYED.**



Town Food Service Equipment Company, Inc. 718/388-5650 outside New York State 800/221-5032

OPERATING INSTRUCTIONS

- 1) Make sure the unit is properly assembled with burner base, cover, outer jacket, rice pot and cover in the proper positions. The rice in the pot should be prepared by the methods described on page 10. If the components are not properly positioned, the unit will not operate normally.
- 2) Turn gas valve to **ON** position (figure 2). Position the jacket window directly over **#1 START** and **#2 COOK** buttons.
- 3) Push the left button marked **#1 START** down and wait for a click, then release it. This is the ignition lever and the pilot should light. The red button marked **WARM** controls the pilot and is hidden by the **#1 START** button when off. Pushing the **#1 START** button engages and exposes the **WARM** button. It will stay down until pushed up to extinguish the pilot. If the pilot does not lit, repeat. If the pilot continues to light, see **TROUBLE SHOOTING** on page 14.
- 4) After the pilot has lit, push the **#2 COOK** main burner control button to ignite the main burner and start cooking. The cook cycle takes approximately 22 minutes. When the cook button turns to the **OFF** position, allow the rice to remain undisturbed for an additional 10 minutes to cure. The curing time allows the rice to become fluffy and improves taste.

WARNING

When igniting the pilot, position the jacket window directly over **#1 START** and **#2 COOK** buttons. Use caution when igniting pilot and maintain a safe distance from the jacket window (figure 3).

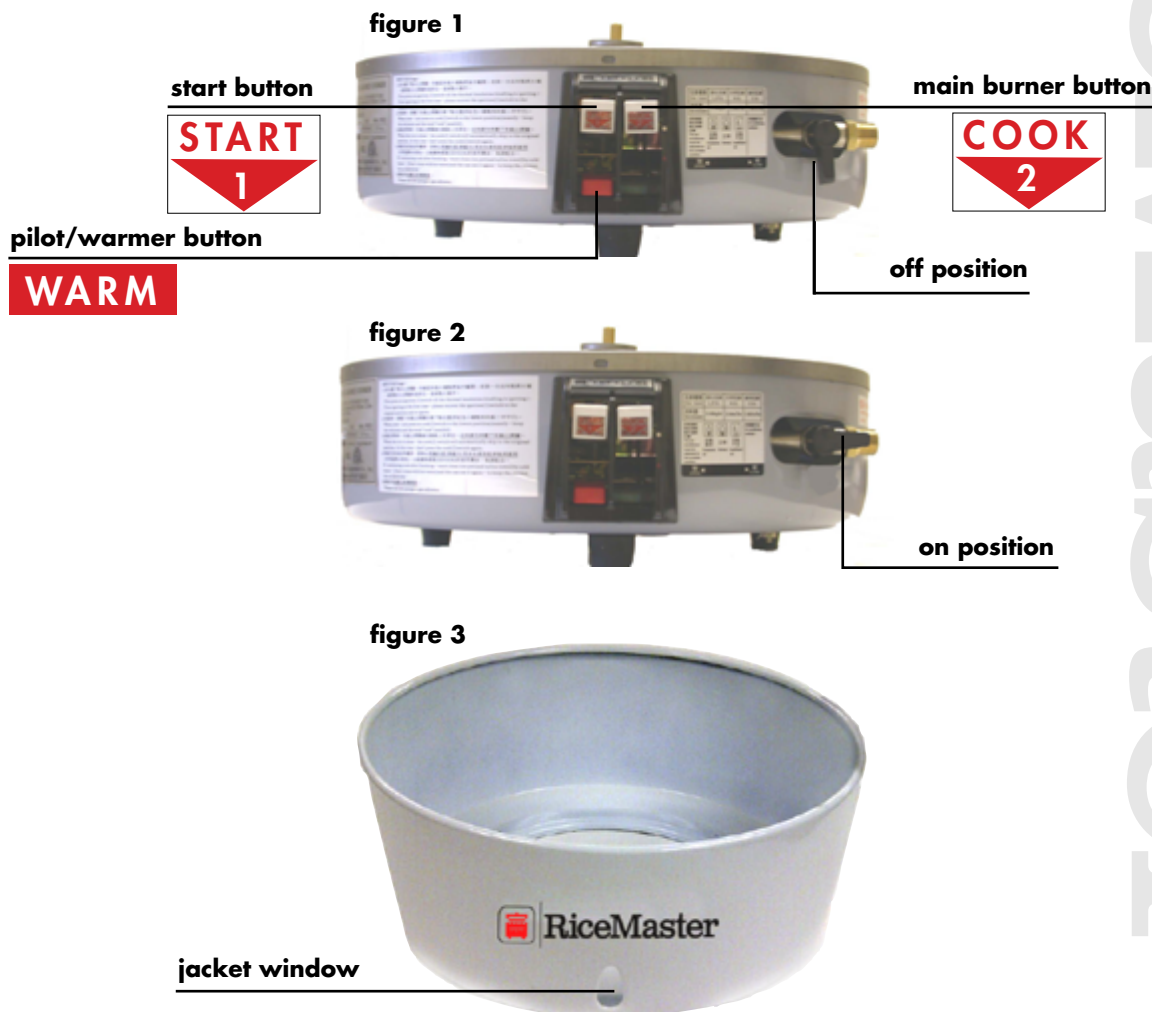

HOW TO USE YOUR RICE COOKER

ASSEMBLY AND COOKING

Step 1

Place the rice pot with rice and water in the outer jacket. The rice pot must be level and sit evenly in the jacket.

Step 2

Place the lid on the rice pot and light the burner. To light the burner, refer to **OPERATING INSTRUCTIONS** on page 8. Do not open the lid while cooking. When cooking is finished, the **#COOK 2** button will pop up and the main burner will automatically shut off. Do not serve the rice yet— refer to **RICE COOKING TIPS** on page 10, for information on curing rice. The pilot keeps cooked rice hot (about 160°F/71°C) for 2 hours.

Step 3

Shut pilot off by pushing up the red **KEEP WARM** button. Refer to the **LIGHTING AND SHUT DOWN INSTRUCTIONS** on page 4 for additional information

See the **SHUT DOWN** portion of the **OPERATING INSTRUCTIONS** on page 4.

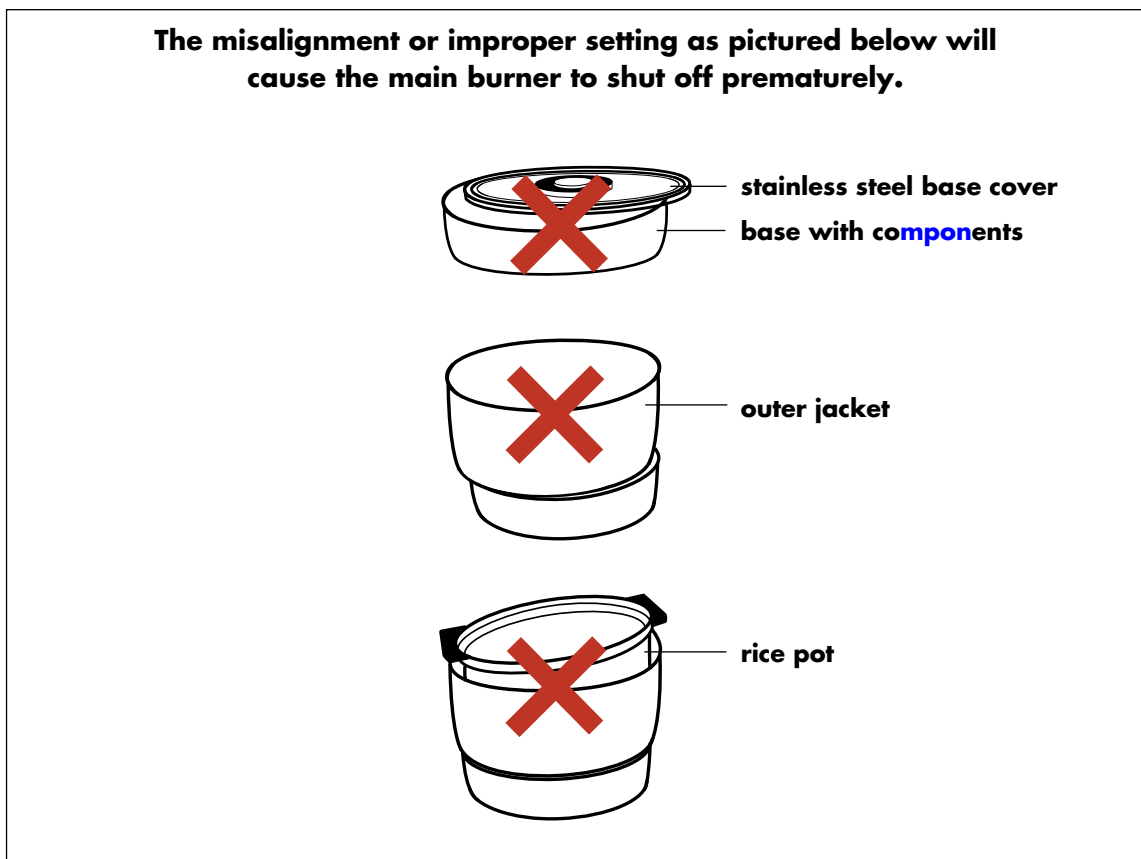

SEASONING THE RICE POT

A new rice pot should be carefully seasoned once before use. Wash rice in the rice pot with tap water. Remove the rice, from milky liquid and replace with fresh water and light the pilot to begin the cooking process. Using tap water to season the pot may cause discoloration but will effect neither the unit nor the cooked rice.

VISUAL BURNER CHECK

When operating, burner flame should be light blue in color and should have no yellow tips or lifting from the burner. The air/gas mixture can be adjusted by moving the air shutter arm under the unit below the main gas valve.



RICE PREPARATION

- Measure rice with the measuring cup*. The unit will cook a minimum of 2-3 full measuring cups* of dry rice. Uncooked rice volume doubles after cooking.
- Determine the quantity of rice to be cooked. The amount of rice should be enough to completely cover the bottom of the pot. The maximum is 10 full measuring cups*. Place the rice in the pot and wash 4 or 5 times with fresh water. When water is almost clear and drain rice.
- Cover the rice with 1" of water. An alternate method is to gently place one's hand on the rice. Add enough water to reach the center of the knuckles where the fingers join the hand.
- Cover rice pot with stainless steel cover*. Check to be sure that the pot is properly positioned on the cooker and that the water level is of uniform depth covering the rice. For tender rice, let it soak in pot for about 10 minutes before igniting main burner.

*supplied with unit

RICE COOKING TIPS

- When cooking a half pot of rice, turn gas valve to the full **ON** position, taking note of flame on burner. Turn gas valve slightly towards **OFF** position until flame is reduced by half.
- Length of cooking time will vary according to type of gas used, gas pressure to burner, and quantity of rice being cooked.
- When main burner automatically shuts off, the rice should be broken up or turned using a utensil that will not damage the pot. Cover the rice and wait 10 to 15 minutes allowing the rice to cure before serving. Rice will remain hot (about 160°F/71°C) for 2 hours.

CARE AND MAINTENANCE

- The rice pot is designed for use in the [RM-55N-R](#), [RM55P-R](#), [RM-50N-R](#) and [RM-50P-R](#) only. Do not put the pot on any other heat source— it will damage the thermostatic element and will not operate properly.
- Keep the Piezo electric ignition clean and dry by wiping with a dry cloth. Do not press the ignition while touching electrode—electric shock will result. If lighter fails to spark, check that it is clean, dry, and that the black neoprene line from the ignition assembly is connected. Call your dealer or gas service for assistance if the unit continues to malfunction.
- Cooker base connected to gas supply may be cleaned with a damp cloth and mild soap or detergent. Never immerse the unit into water. Be careful to not strain gas connection as this will damage the manifold and could be very dangerous, resulting in a gas leak.
- Rice pot, cover, and enamel body may be removed for cleaning. These parts should be cleaned and carefully reassembled to prevent damage to the unprotected cooking sensor. Do not force these parts to fit—they assemble easily if properly positioned. Refer to the illustrations on page 9 of the **ASSEMBLY AND COOKING** section.
- After unit is cleaned and assembled, leave all gas valves in **OFF** position, rice pot centered and resting evenly on enamel outer body of unit.



Vicente's Mexican Rice

30 servings

INGREDIENTS

- 4 ounces peanut oil
- 6 cups long grain rice
- 6 cups water
- 3 cups beef stock
- salt and freshly ground pepper to taste
- crushed chilies to taste
- generous pinch of saffron
- 3 large tomatoes, peeled, seeded and chopped
- 4 garlic cloves
- 1 red bell pepper, diced
- 1 onion, peeled and chopped

DIRECTIONS

Place peanut oil and rice into rice pot.

Press the **ON** button and then the **#1 COOK** button.

Stir rice in peanut oil approximately every minute until **COOK** light goes off.

Pour the 6 cups of water and remaining ingredients into the rice. Stir thoroughly and cover with lid.

Set timer for 30 minutes to soak the rice.

After 30 minutes stir thoroughly. Push the **#1 COOK** button.

When the **COOK** light goes off the **HOLD** light will come on. Allow the seasoned rice to cure for 10 to 15 additional minutes.

Rice is now ready to serve.

Buen provecho!

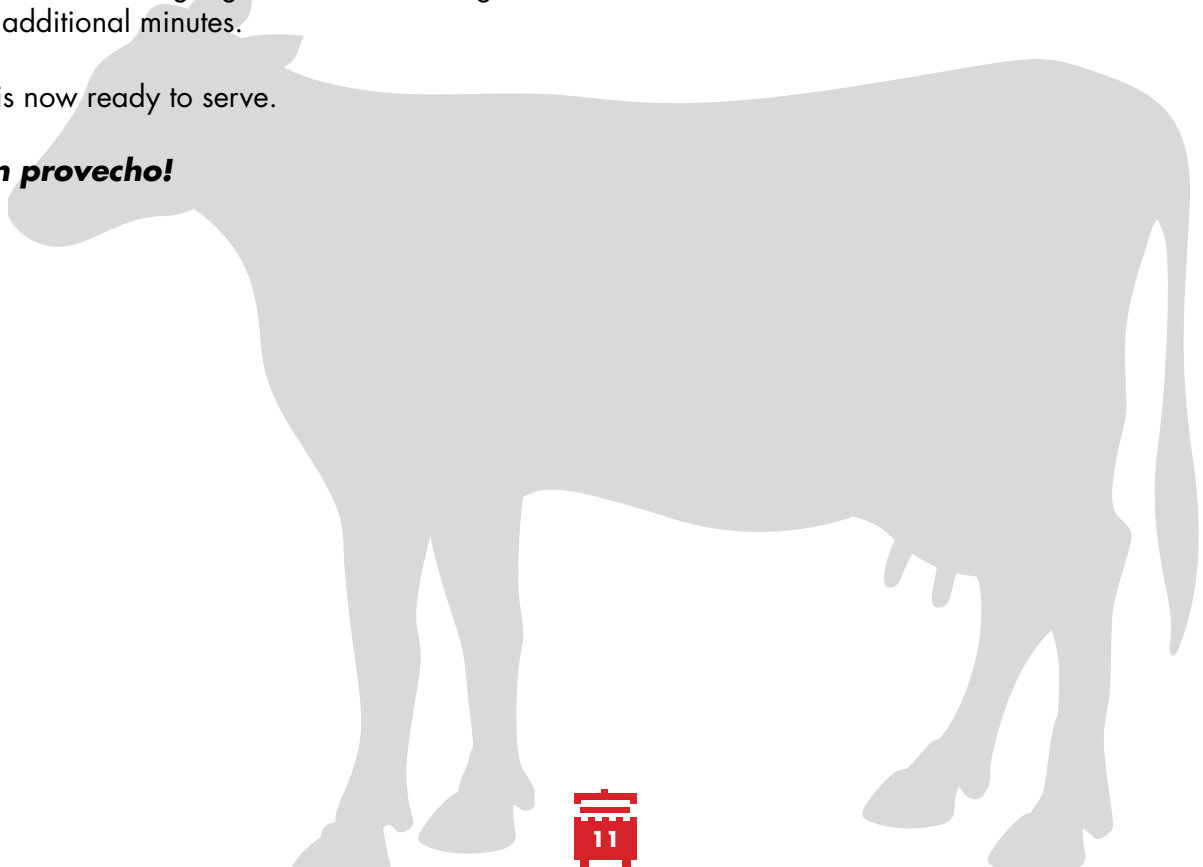

Maria's Mexican Rice*

30 servings

INGREDIENTS

- 8 oz. vegetable or peanut oil
- 4 quarts cooled chicken stock
- 3 lbs. washed rice
- juice of one lemon
- 2-3 sprigs finely chopped cilantro
- 3 boneless chicken breasts, precooked and cubed
- 2 cloves garlic, smashed, finely chopped
- 3 tablespoons salt
- 1 28 oz. can crushed tomatoes
- 2 finely chopped jalapeños

DIRECTIONS

Push the **#1 START** button to light the pilot. Verify ignition of the pilot through the jacket window. Push the **#2 COOK** button and light the main burner. Verify ignition of the main burner through the jacket window. Add a sufficient amount of oil to cover the bottom of the rice pot. Allow the oil to heat.

The sensor in the bottom of the pot is designed to turn the rice cooker off when it senses there is no water remaining in the pot. The oil in the bottom of the pot is being heated by the burner and will exceed the temperature of boiling water. At this point the sensor will make a click sound and pop into its expanded position as the temperature of boiling water has been exceeded. This causes the **#2 COOK** button to jump to the **OFF** position and the burner will shut off.

Mexican Rice is fried before liquids are added. The oil must be at frying temperature, about 375°F. To do this, push the **COOK-2** button once again to continue heating the oil. **BEWARE** the automatic shut off feature of the sensor is now disabled and the unit will not shut off automatically. To turn off the main burner lift the **#2 COOK** button.

Heat the oil to frying temperature. Add grains of rice to test the temperature of the oil. When the test grains of rice sizzle and turn white, add the remaining rice. Fry the rice by allowing it to cook for 30 seconds, and mix thoroughly. Let it fry for an additional 30 seconds and mix again. Repeat this process until the rice begins to 'cashew' or have a light brown color, about 7-10 minutes.

After the rice has started to change color, add the garlic and stir for 1 more minute. At this point wearing a heat resistant mitt is imperative as the pot is very hot and the liquids about to be added will vaporize quickly and can scald the skin. Stir in crushed tomatoes and fry for one more minute. Turn off the burner by raising the **#2 COOK** button to its **OFF** position. Add the remaining of the ingredients and mix. About 4-5 minutes after turning off the main burner, listen for a click indicating that the sensor has reset to its original state restoring the automatic capabilities.

Relight the main burner by pushing down the **#2 COOK** button. Verify ignition through the jacket window. The unit will now cook the rice and automatically shut off when the rice is done—about 15 minutes. When the unit shuts off, allow the rice to cure undisturbed in the rice cooker for 10 minutes. Mix and serve.

NOTES

Consistency of rice will vary depending on amount of chicken stock used. For very spicy rice add additional jalapeños to taste. Be creative— try adding peas, corn, or finely chopped bell peppers.

Use the rice cooker to braise the chicken.

The braised chicken adds flavor to the rice when fried in the same pot. **Buen provecho!**

* Recipe compliments of Maria Asuncion Acuirre de King,
Dim Sum King, Veracruz, Mexico.



TROUBLE SHOOTING

If rice cooker is not working properly, perform the following diagnostic tests:

- 1) With the pilot lit and an empty rice pot in the cooker, start the main burner. Expect to hear a click after 3 minutes and 15 seconds. The click is the sound of the sensor reaching shut off temperature. If the main burner does not shut off, refer to difficulty item below: **main burner does not shut off automatically.**
- 2) If the main burner shuts off, the sensor is working. Pour a gallon of water into the rice pot and listen for the click of the sensor returning to its cooking position. After the pilot is lit, start the main burner and cover the rice pot. If the cooker shuts off within 20 minutes, remove the cover and allow the water to evaporate. If the cooker shuts off after the water has evaporated, the unit is working normally. Contact Town Food with any questions about the operation of the unit.

If the cooker shuts off too soon, never press the cook button a second time. The rice will burn. The sensor has activated and must cool to be reset.

DIFFICULTY	CAUSE	REMEDY
main burner shuts off before rice is done, pilot remains lit	insufficient water to cook rice	cook with proper amounts of water
	base cover and rice pot and/or outer jacket are not correctly positioned	position base cover, rice pot an outer jacket correctly according to diagram on page 9
rice cooker shuts off too soon	overall height of shut off stem assembly is too tall	replace shut off stem assembly or remove any washers from existing shut off stem assembly (see figure 1, page 13)
main burner does not shut off automatically	shut off stem tip is worn	replace tip according to figure 1, page 13
	sensing element fails	replace sensing element according to figure 2, page 13
pilot will not light	spillage on pilot	clean or replace main pilot burner
	ceramic electrode disconnected from Piezo ignition assembly	reconnect Piezo ignition to ceramic electrode
	pilot ignition line will not ignite properly	be sure orifice is clean and positioned in ceramic electrode holder
insufficient pilot burner flame	insufficient gas pressure	check gas pressure ensure all gas valves are open contact gas supplier if problem persists
	main pilot orifice is blocked	clean or replace main orifice

TROUBLE SHOOTING

DIFFICULTY	CAUSE	REMEDY
yellow main burner flame	unit connected to incorrect type of gas	check rating plate to confirm unit is connected to the correct type of gas
black soot collects on bottom of rice pot	air shutter is closed	adjust/open air shutter
flame lifts off main burner	spillage on main burner or blockage inside main burner	clean or replace main burner
	spillage on main burner	clean or replace main burner
	excessive air	adjust/close air shutter
boiling over	too much water	cook with proper amount of water, and refer to RICE PREPARATION on page 10
pot interior turns gray	rice pot hasn't been cleaned for an extended period of time	thoroughly wash and dry pot
	pot is discolored by boiling water	discoloration will not harm rice pot or rice but may turn gray

Units requiring warranty service must be returned to Town Food Service Equipment Co., Inc. for repair. See **GAS COOKER LIMITED WARRANTY** on page 15. Call Town at 718/388-5650 with model and serial number and request authorization to return for warranty repair number (RGA #). Non warranty parts are also available by contacting Town.

If rice cooker shuts off too soon, remove any washers above or below perforated circular metal disc below.

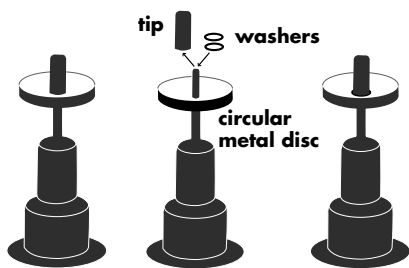

1. Remove rice pot.
2. Locate shut off stem in center of burner.
3. Unscrew stem tip.
4. Remove lightweight washers (about 1/8" thick) under tip.
5. Reinstall tip.
6. Ensure spring returns to the top of its travel.

figure 1
shut off stem assembly

If main burner does not shut off automatically the encased sensor may have to be replaced as pictured below.

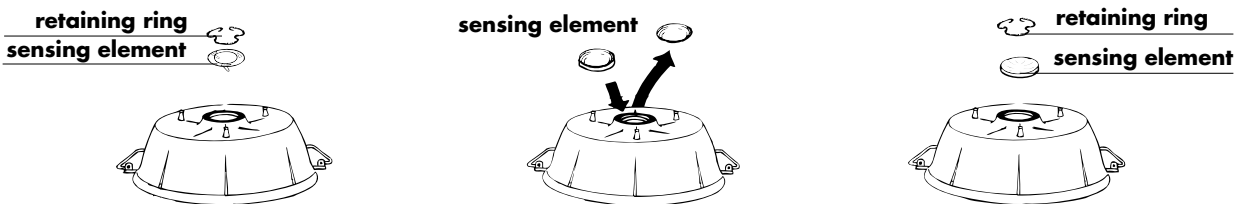

1. Remove and invert rice pot.
2. Remove retaining ring.
3. Replace sensing element. **IMPORTANT** concave side of sensing element must be exposed
4. Reinstall retaining ring.

figure 2
replacing sensing element

GAS RICE COOKER LIMITED WARRANTY

Town Food Service Equipment Co., Inc. (Town) warrants its rice cookers to be free of defects in materials and workmanship, subject to the terms specified below. This warranty is limited to parts replacement and does not include any labor allowance. Any service charges or charges for parts replacement is the customer's responsibility.

Town warrants gas RiceMasters to be free of defects in materials or workmanship for a period of 6 months. The warranty period for all electric and gas rice cookers shall commence at the the time of shipment from Town. The warranty period may be extended, at Town's discretion, if proof of installation (specifying model and serial number) was at a later date, but in no case shall warranty be extended beyond 9 months after date of shipment from Town.

Parts and labor are covered for the warranty period for properly packaged units returned to Town prepaid. Town cannot be responsible for shipping damages to any unit returned with improper packaging. Parts that have failed due to defective materials or workmanship will be replaced at no charge. Units repaired under warranty will be returned freight prepaid. Warranty for the new parts will be for the remainder of the original warranty period. Freight will be added to the invoice for non-warranty repairs. There will be no credit for defective units returned.

Customers are requested to clean units before returning them for service. Units returned in abused or unsanitary condition will not be serviced without the customer's consent to pay an appropriate labor charge for labor to clean and repair the rice cooker. If the customer does not agree, the unit will be returned without cleaning or repair. This warranty does not cover any failures or operating difficulties due to accident, abuse, misuse, alteration, misapplication, improper installation or improper maintenance or service. Town does not authorize any person or company to assume on it's behalf any obligation or liability in connection with this unit in any manner whatsoever. If warranty service becomes necessary, bring the unit to the dealer where the rice cooker was purchased. Request that it be carefully packed. Be sure to insulate the enamel jacket from the rice pot. If the pot is allowed to contact the enamel jacket during shipment it will become chipped. If the base is not properly packed it may become dented. Town will charge for repairs to units returned and damaged due to abuse for any reason. The returning agency is entitled to request from the purchaser the costs of shipping and handling charges to return the unit. Before any unit is returned, call Town at 718/388-5650 and request a Return Goods Authorization (RGA). Be advised this RGA is only authorization to return the unit for evaluation. No credit of any kind may be taken arising from an RGA. Unit will be inspected to verify the difficulty for which it was returned. Once the difficulty is verified, it will be repaired and the unit returned at no charge if due to faulty materials and/or workmanship. If defective for any other reason, the unit will be repaired and the customer will be charged for the cost of the labor and materials for the repair plus return delivery costs.

If unit must be returned to Town, carefully pack (preferably in the original carton), send prepaid, adequately insured, and with the RGA clearly marked on the outside of the package.



RECORD OF OWNERSHIP

For your records, please record the following information. It will be required in the event service is required.

Date of purchase _____ **Model** _____ **Serial Number** _____ **Gas Type** _____

Dealer _____ **Dealer Phone Number** _____



TOWN

發富公司

FOOD SERVICE EQUIPMENT CO., INC.

72 Beadel Street Brooklyn, NY 11222

718/388-5650 outside New York State 800/221-5032 facsimile 718/388-5860

www.townfood.com