

USER GUIDE

SAFETY • INSTALLATION & INTEGRATION • OPERATING INSTRUCTIONS • MAINTENANCE • **SERVICE**

Parts

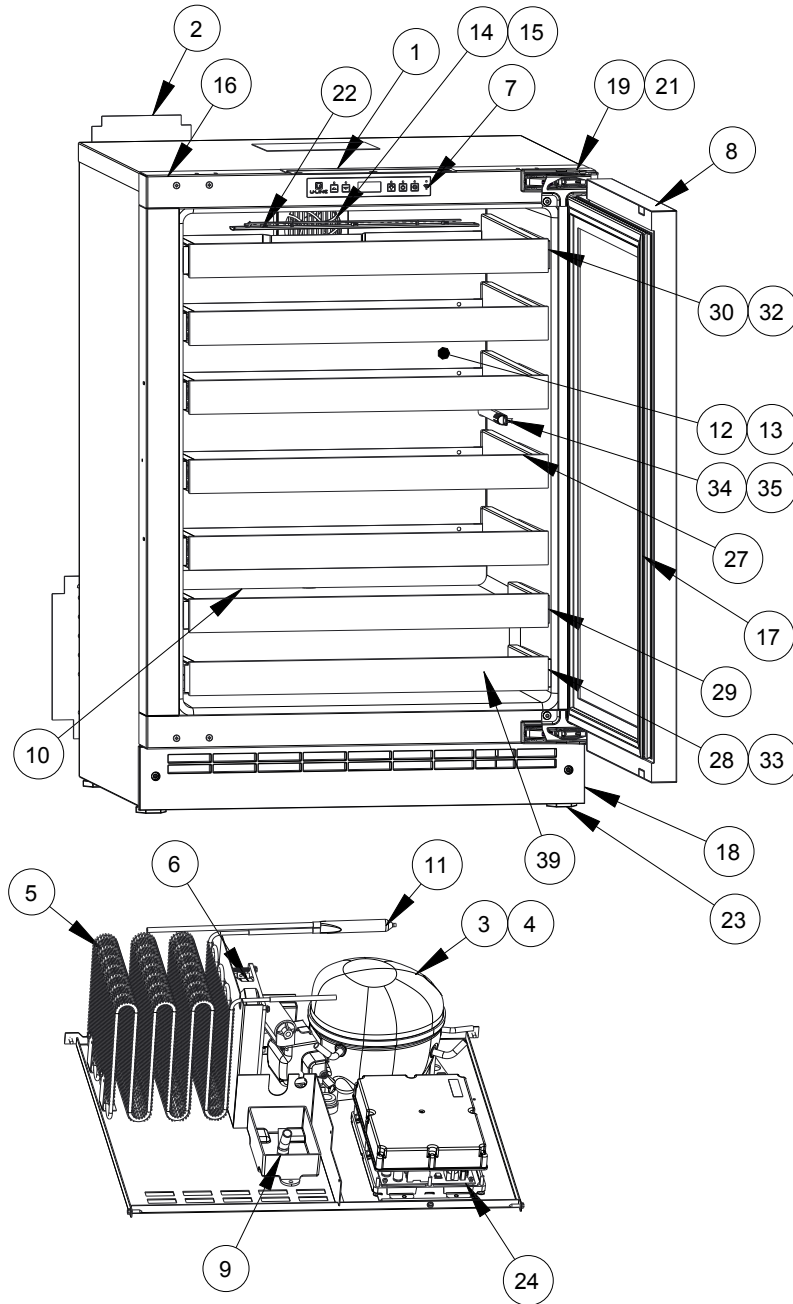

U-2224WCINT-60A

Item	Description	U-Line P/N
1	Anti tip brackets w/screws	80-54012-00
2	Back panel	80-54086-00
3	Compressor electricals only	80-54149-00
4	Compressor w/electricals	80-54193-00
5	Condenser assembly	80-54043-00
6	Condenser fan w/screws	80-54014-00
7	Display module	80-54007-00
8	Door assembly w/o hinges	80-54089-00
9	Drain pan w/double sided tape	80-54217-00
10	Drain trough assembly	80-54399-00
11	Drier	80-54055-00
12	Evaporator assembly	80-54057-00
13	Evaporator cover	80-54042-00
14	Evaporator fan	80-54321-00
15	Evaporator fan w/cover and screws	80-54151-00
16	Frame assembly	80-54820-00
17	Gasket, door, injection molded	80-54039-00
18	Grille w/ screws	80-54040-00
19	Hinge covers (2 pcs)	80-54001-00
20	Hinge mounting hole covers(2)	80-54024-00
21	Hinges (2) w/screws and covers	80-54013-00
22	LED light strip and cover assy	80-54000-00
23	Leg Levelers (4)	80-54019-00
24	Main board (no case or wires)	80-54008-00
25	Packaging	80-54159-00
26	Power cord	80-54171-00
27	Rack assembly	80-54010-00
28	Rack assembly bottom	80-54091-00
29	Rack Assembly, lower	80-54817-00
30	Rack Assembly, middle	80-54818-00
31	Reed switch	80-54134-00
32	Slide assembly, long	80-54047-00
33	Slide assembly, short	80-54048-00
34	Thermistor (1 pc)	80-54006-00
35	Thermistor cover and pin	80-54023-00
36	Tool, leg leveler	80-54794-00
37	WIFI antenna	80-54804-00
38	Wire Harness, board	80-54251-00
39	Wood fronts w/screws	80-54498-00