

QUICK START GUIDE

Register your product
at u-line.com
and receive a free cleaning kit
ULANUGGETCLEANKIT
(Cleaner, Hose and Funnel)
Nugget Ice Machines Produced Sept. 2021 and Later



Nugget Ice Machine

- ADA, 1 & 3 Class

QUICK START GUIDE

WELCOME TO U-LINE

Congratulations on your U-Line purchase. Your product comes from a company with over five decades of premium modular ice making, refrigeration, and wine preservation experience. U-Line continues to be the American leader, delivering versatility and flexibility for multiple applications including residential, light commercial, outdoor and marine use. U-Line's complete product collection includes Wine Captain® Models, Beverage Centers, Clear Ice Machines, Nugget Ice Machines, Crescent Ice Makers, Glass & Solid Door Refrigerators, Drawer Models, Freezers, Combo® Models, and more.

U-Line has captivated those with an appreciation for the finer things with exceptional functionality, style, inspired innovations, and attention to even the smallest details. We are known and respected for our unwavering dedication to product design, quality, and selection. U-Line is headquartered in Milwaukee, Wisconsin, and has shipped product to five continents for over two decades and is proud to have the opportunity to ship to you.

U-LINE — RIGHT PRODUCT. RIGHT PLACE. RIGHT TEMPERATURE®

PRODUCT INFORMATION

IMPORTANT - Before connecting your new Nugget Ice Machine, be sure to carefully follow all manufacturer recommendations throughout this guide regarding water quality. Please see WATER HOOKUP section for more information.

Looking for additional information on your product? User Guides, Spec Sheets, CAD Drawings, Compliance Documentation, and Product Warranty information are all available for reference and download at u-line.com.

PROPERTY DAMAGE / INJURY CONCERNS

In the unlikely event property damage or personal injury is suspected related to a U-Line product, please take the following steps:

1. U-Line Customer Care must be contacted immediately at +1.414.354.0300.
2. Service or repairs performed on the unit without prior written approval from U-Line is not permitted. If the unit has been altered or repaired in the field without prior written approval from U-Line, claims will not be eligible.

GENERAL INQUIRIES

U-Line Corporation
8900 N. 55th Street
Milwaukee, Wisconsin 53223 USA
Monday - Friday 8:00 am to 4:30 pm CST
T: +1.414.354.0300
Email: sales@u-line.com
u-line.com

SERVICE & PARTS ASSISTANCE

Monday - Friday 8:00 am to 4:30 pm CST
T: +1.414.354.0300
Service Email: onlineservice@u-line.com
Parts Email: onlineparts@u-line.com

CONNECT WITH US



Designed, engineered and assembled in WI, USA

QUICK START GUIDE

This Quick Start Guide covers the basics of installation and general use of your product.

CONTENTS

Safety and Warning	4
Environmental Requirements	5
Electrical	5
Water Hookup	6
Measure TDS	6
Drain	8
Door Swing	9
Door Adjustments	10
General Installation	13
Integrated Panel Installation	14
Control Operation	15
First Use	16
Ice	17
Cleaning	17
Warranty	19

For more details, see the complete User Guide & Service Manual on u-line.com.



This product is eligible for an additional one-year warranty at no charge when you register your product on u-line.com. See complete warranty for details.

QUICK START GUIDE

Safety and Warning

NOTICE

Please read all instructions before installing, operating, or servicing the appliance.

Use this appliance for its intended purpose only and follow these general precautions with those listed throughout this guide:

SAFETY ALERT DEFINITIONS

Throughout this guide are safety items labeled with a Danger, Warning, or Caution based on the risk type:



Danger means that failure to follow this safety statement will result in severe personal injury or death.



Warning means that failure to follow this safety statement could result in serious personal injury or death.



Caution means that failure to follow this safety statement may result in minor or moderate personal injury, property, or equipment damage.



This unit contains R600a (Isobutane) which is a flammable hydrocarbon. It is safe for regular use. Do not use sharp objects to expedite defrosting. Do not service without consulting the "R600a specifications" section included in the User Guide. Do not damage the refrigerant circuit.



Service must be done by factory authorized service personnel. Any parts shall be replaced with like components. Failure to comply could increase the risk of possible ignition due to incorrect parts or improper service.

CALIFORNIA PROPOSITION 65

This product contains chemicals known to the state of California to cause cancer and birth defects or other reproductive harm.

www.P65warnings.CA.gov

QUICK START GUIDE

Environmental Requirements

This model is intended for indoor/interior applications only and is not to be used in installations that are open/exposed to natural elements.

This unit is designed to operate between 50°F (10°C) and 100°F (38°C). Higher ambient temperatures may reduce the unit's ability to reach low temperatures and/or reduce ice production on applicable models.

For best performance, keep the unit out of direct sunlight and away from heat generating equipment.

In climates where high humidity and dew points are present, condensation may appear on outside surfaces. This is considered normal. The condensation will evaporate when the humidity drops.



Damages caused by ambient temperatures of 40°F (4°C) or below are not covered by the warranty.

Electrical

SHOCK HAZARD – Electrical Grounding Required. Never attempt to repair or perform maintenance on the unit until the electricity has been disconnected.

Never remove the round grounding prong from the plug and never use a two-prong grounding adapter.

Altering, cutting or removing power cord, removing power plug, or direct wiring can cause serious injury, fire, loss of property and/or life, and will void the warranty.

Never use an extension cord to connect power to the unit.

Always keep your working area dry.

NOTICE

Electrical installation must observe all state and local codes. This unit requires connection to a grounded (three-prong), polarized receptacle that has been placed by a qualified electrician.

The unit requires a grounded and polarized 115 VAC, 60 Hz, 15A power supply (normal household current). An individual, properly grounded branch circuit or circuit breaker is recommended. A GFCI (ground fault circuit interrupter) is usually not required for fixed location appliances and is not recommended for your unit because it could be prone to nuisance tripping. However, be sure to consult your local codes.

QUICK START GUIDE

Water Hookup



TO PREVENT DAMAGE TO YOUR ICE MACHINE AND/OR VOID YOUR WARRANTY, FOLLOW ALL WATER SUPPLY GUIDELINES AS LISTED BELOW.

PREPARE PLUMBING

The water valve uses a standard 1/4" (6.35 mm) compression fitting. U-Line recommends using accessory water hook up kit – part # 80-54674-00. The kit includes a 10' (3 m) braided flexible water supply line and a brass hose fitting.



Plumbing installation must observe all state and local codes. All water and drain connections MUST BE made by a licensed/qualified plumbing contractor. Failure to follow recommendations and instructions may result in damage and/or harm.

Water Supply

When connecting the water supply, please note the following:

- Water Mineral Content must meet the following:
 - TDS: less than 200 ppm (mg/l)
 - Hardness: Less than 200 mg/l (12 gpg)
- **Water supply MUST NOT be from a water softener.**
- A TDS meter is included with your unit
- Water Treatment Options
 - TDS level of 200 ppm or higher and/or a hardness of 12-19 gpg can be treated by U-Line's in-line water filter accessories available at u-line.com or your local dealer:
 - ULALINEFILTER — Standard
 - ULALINEFILTERL — Large
 - ULALINEFILTERHEAD — 3/8" NPT, initial setup requires head & filter
 - Use bypass level 6

Measure Water TDS

Every Nugget Ice Machine comes with a TDS meter similar to the one below. The TDS meter measures the **Total Dissolved Solids** level that exists in the water supply; this is measured in ppm (parts per million).

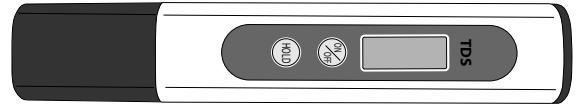

The TDS meter does not test the toxicity of the water and is not to be used to determine potability. A TDS METER CANNOT DETECT THE TOXINS THAT MAKE WATER UNSAFE TO DRINK.

1. Turn on sink faucet and let run for 30 seconds.
2. Fill a clean glass (2 inches of water is sufficient).
3. Remove cap from meter.
4. Turn on meter and immerse meter into the water.

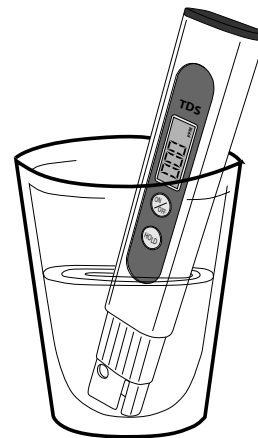

5. Leave meter immersed for 30 seconds.
6. Remove meter and check the readout for the TDS level in ppm - to save the reading, press the hold button.

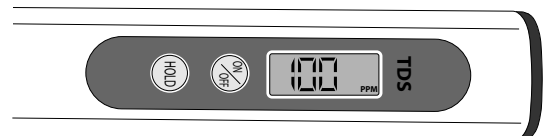

7. Turn off meter, dry off, and replace cap.

QUICK START GUIDE

Based upon the TDS measurement, see the below table to determine the correct filter required to protect the ice machine.

Water Quality	1-3 Users	4+ Users
200 TDS and/or 12 gpg hardness or less	Required Standard Filter Change 1x per year	Required Large Filter Change 1x per year
201-400 TDS and/or 12-19 gpg hardness	Required Large Filter Change 1x per year	Required Large Filter Change 2x per year
400+ TDS, and/or 20+ gpg hardness	Contact your local water professional	

- The water pressure should be between 20 and 120 psi (138 and 827 kPa).
- The water line MUST have a shut-off valve in the supply line.
- The water line should be looped into 2 coils. This will allow the unit to be removed for cleaning and servicing. Make certain that the tubing is not pinched or damaged during installation.

CAUTION

Do not use any plastic water supply line. The line is under pressure at all times. Plastic may crack or rupture with age and cause damage to your home.

Do not use tape or joint compound when attaching a braided flexible water supply line that includes a rubber gasket. The gasket provides an adequate seal – other materials could cause blockage of the valve.

Failure to follow recommendations and instructions may result in damage and/or harm, flooding or void the product warranty.

Use new hose set. Do not reuse old hose set.

CAUTION

Turn off water supply and disconnect electrical supply to unit prior to installation.

Use caution when handling back panel. The edges could be sharp.

HOOKUP WATER

1. Turn off water supply and disconnect electrical supply to product prior to attempting installation.
2. Remove the back panel.
3. Thread water line through back panel hole (with bushing).
4. Locate water valve inlet and connect to valve.

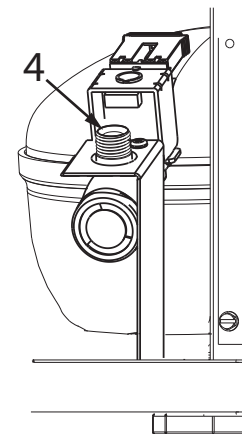
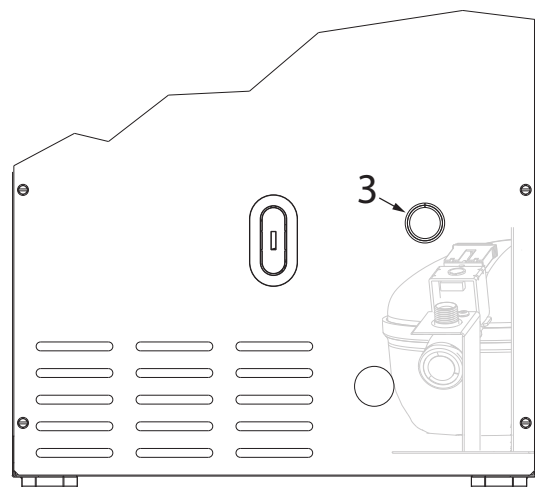

5. Turn on water supply and check for leaks.
6. Reinstall back panel.

QUICK START GUIDE

Drain

Model numbers including "CL" or "NB" do not include a factory installed drain pump.

Model numbers including "CP" or "NP" include a factory installed drain pump.

DRAIN CONNECTION



If your U-Line unit did not come with a factory installed drain pump you must use a gravity style drain connection. For assistance in determining if your unit has a pump please contact U-Line. The floor drain must be large enough to accommodate drainage from all attached drains. Follow these guidelines when installing drain lines to prevent water from flowing back into the ice maker storage bin and/or potentially flowing onto the floor, which may result in personal injury or property damage.

Drain can NOT be located directly below the unit. Unit has a solid base that will not allow the unit to drain below itself.

There is a possibility that hose connections may have loosened during shipment.

Verify all connections and fittings are free from leaks.

GRAVITY DRAIN

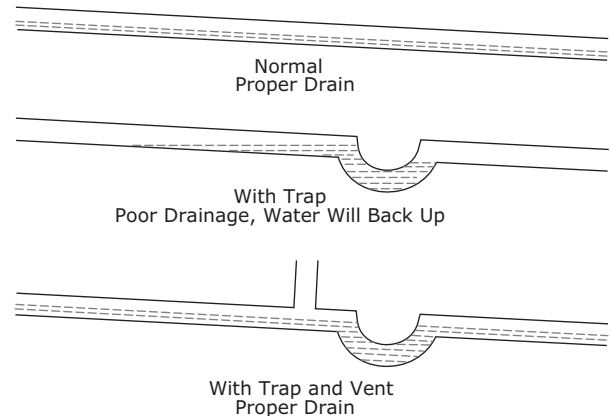

A gravity drain may be used if:

Drain line has at least a 1" drop per 48" (approximately 2 cm drop per 100 cm) of run.

Drain line does not create traps and is vented per local code.

1. Cut the pre-installed drain tube to length.
2. Connect to your local plumbing per the local code.
3. If necessary, insulate drain line to prevent condensation.



Failure to connect water supply or drain line connections properly can result in personal injury and property damage. Gravity drain connections must be routed downward from the rest of the unit at the rate of 1/4" per foot (1 cm per 50 cm).

QUICK START GUIDE

FACTORY INSTALLED DRAIN PUMP

If your drain line will run up to a stand pipe, disposal or spigot assembly, or does not otherwise meet the requirements for a gravity drain, you may have ordered a pre-installed U-Line P60 drain pump.

If you need to install a P60 drain pump into your unit, see DRAIN PUMP section in the User Manual.

See below for typical installations requiring a drain pump.

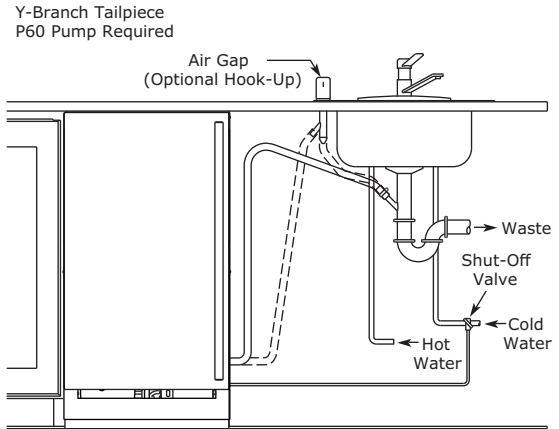

The maximum lift for the P60 drain pump is 10 feet. This must be done as close to the rear of the unit as possible.

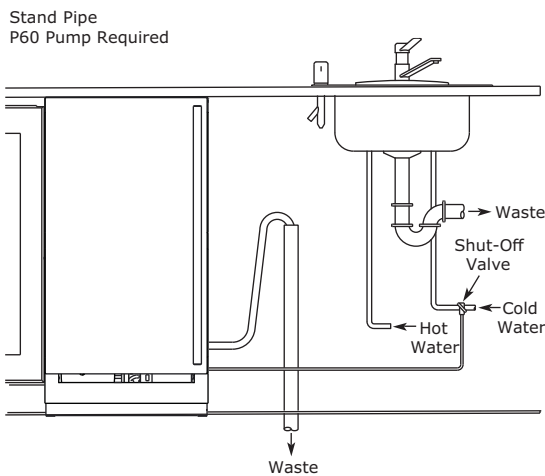

Door Swing

1/2" (13 mm) clearance is recommended from wall on hinge side to allow the door to open 90°. Allow for additional space for any knobs or pulls installed on the integrated panel/frame.

Stainless Steel models that are installed adjacent to a wall require 2-1/4" (57 mm) door clearance on hinge side to allow for door handle.

Units have a zero clearance when installed adjacent to cabinets.

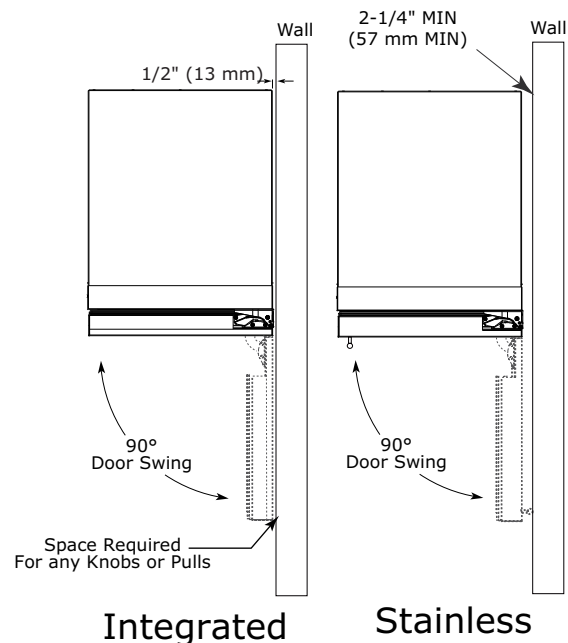
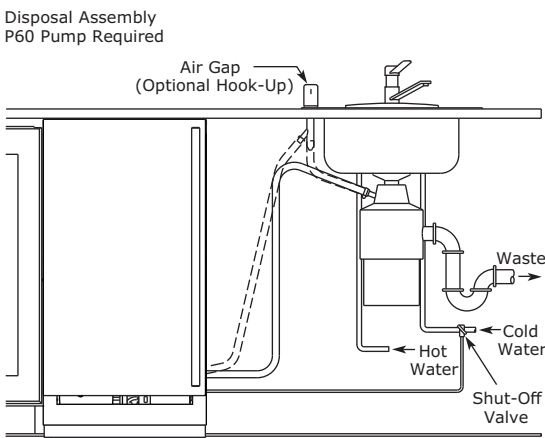

QUICK START GUIDE

Door Adjustments

1 CLASS AND 3 CLASS

DOOR ALIGNMENT AND ADJUSTMENT

Align and adjust the door if it is not level or is not sealing properly. If the door is not sealed, the unit may not cool properly, or excessive frost or condensation may form in the interior.

Properly aligned, the door's gasket should be firmly in contact with the cabinet all the way around the door (no gaps). Carefully examine the door's gasket to ensure that it is firmly in contact with the cabinet. Also make sure the door gasket is not pinched on the hinge side of the door.



Do not attempt to use the door to raise or pivot your unit. This would put excessive stress on the hinge system.

Alignment and Adjustment Procedure

1. Open door and remove gasket near the hinges.
2. Using a T-25 Torx Bit, loosen each pair of Torx head screws on both the upper and lower hinge plates.
3. Square and align door as necessary.
4. Tighten Torx head screws on hinge.
5. Reinstall gasket into the channel starting at the corner.

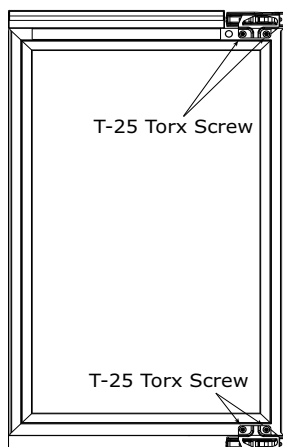

REVERSING THE DOOR

1. Open door.
2. Using T-25 Torx bit loosen screw #1 and remove screw #2 on top and bottom hinge. Slide and remove the door from unit. Completely remove screw #1 on top and bottom.

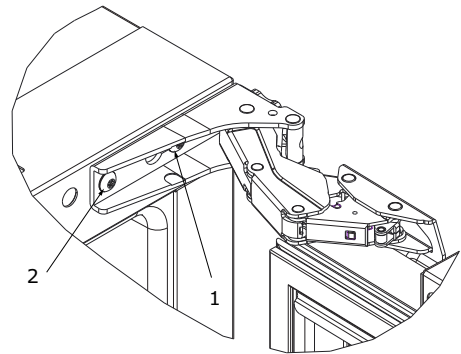

3. Remove caps from screw heads on opposite side (2 on top and 2 on bottom). Using #2 Phillips bit remove the 4 underlying screws. Reinstall the screws and caps on the opposite side.

Note: One hinge includes a metal spacer. Spacer must be used with that hinge when reversing the door.

4. Partially install screw #1 in the outer most holes on top and bottom. Rotate door 180°, align hinge over screw #1 and slide/seat into position. Reinstall screw #2 on top and bottom. Tighten both screws and install hinge cover.

Align and adjust the door:

Align and adjust the door (see DOOR ALIGNMENT AND ADJUSTMENT).

QUICK START GUIDE

Door Adjustments (ADA Model)

HINGE COVER

Hinge cover included with the literature bag is optional.

To install hinge cover:

1. Press hinge cover squarely over hinge.

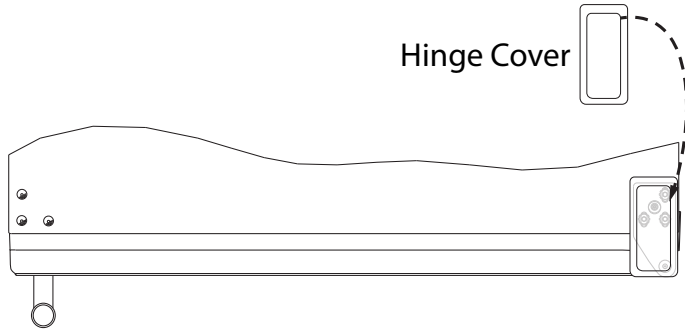

DOOR ALIGNMENT AND ADJUSTMENT

Align and adjust the door if it is not level or is not sealing properly. If the door is not sealed, the unit may not cool properly, or excessive frost may form in the interior.

NOTICE

Properly aligned, the door's gasket should be firmly in contact with the cabinet all the way around the door (no gaps). Carefully examine the door's gasket to ensure that it is firmly in contact with the cabinet. Also make sure the door gasket is not pinched on the hinge side of the door.

To align and adjust the door:

1. Gently pry off hinge cover from top of unit.
2. Loosen (do not remove) top and bottom hinge screws using a Torx T-25 screwdriver on the top and a 1/4" socket on the bottom.
3. Align door squarely with cabinet.
4. Make sure gasket is firmly in contact with cabinet all the way around the door (no gaps).
5. Tighten bottom hinge screws.
6. Tighten top hinge screws and replace hinge cover.

REVERSING THE DOOR

Location of the unit may make it desirable to mount the door on the opposite side of the cabinet.

The hinge hardware will be removed and reinstalled on the opposite side of the cabinet.

TO REVERSE THE DOOR

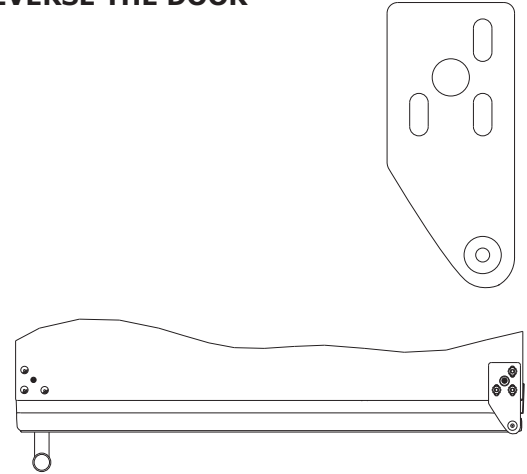

Remove arrow clips:

1. With a pudgy knife or other flat tool, gently pry each arrow clip from hinge mounting holes.
2. Set aside arrow clips to be reused on the opposite side.

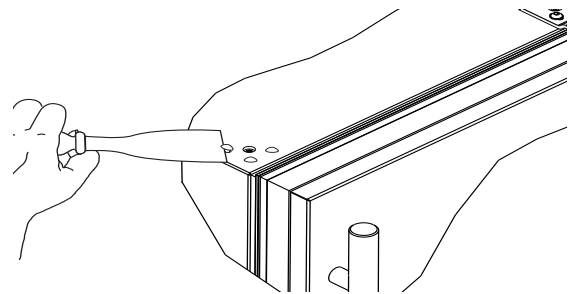

Remove top hinge and door:

1. Remove hinge cover from top of unit
2. Hold door to keep it from falling.
3. Remove top hinge from cabinet using a Torx T-25 screwdriver to remove three screws.

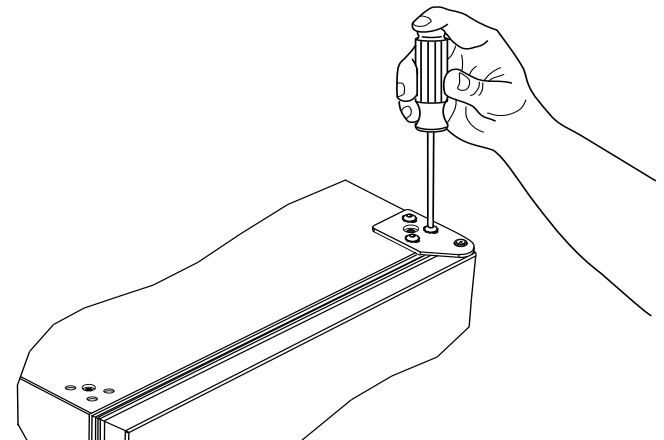

QUICK START GUIDE

- Remove door by tilting forward and lifting door off bottom hinge. Retain shoulder washers; they will be reused.
- Insert arrow clips into holes

Remove bottom hinge:

- Remove bottom hinge from cabinet using a T-25 TORX screw driver to remove three screws.
- Remove corresponding screws on opposite side of cabinet. On some models there may be a nut behind one or both screws on either side.

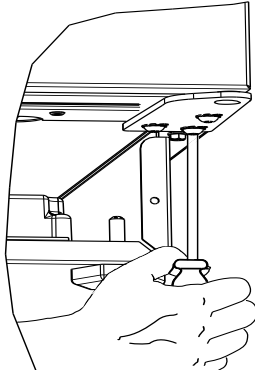

Install bottom hinge:

Install three screws. Replace nuts if used.

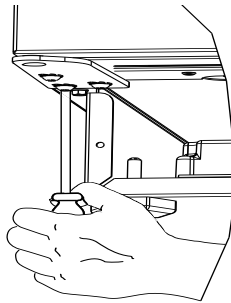

PREPARE DOOR FOR RE-INSTALLATION

Rotate gasket

- With a flat tool, such as a putty knife, gently pry up beneath the gasket and spacer until it is completely free from the door surface.
- Remove the rest of the gasket, by grabbing hold and gently pulling gasket from gasket channel.

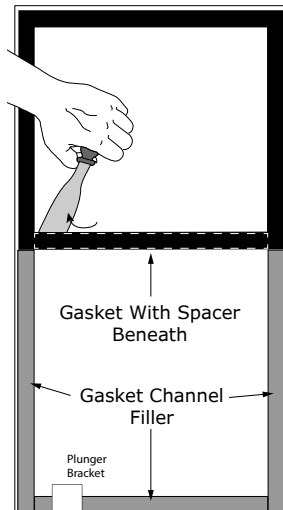

- Remove the 3 pieces of gasket channel filler and set aside to be used on the opposite end.
- Remove 2 screws holding plunger bracket. Reinstall plunger bracket in the gasket channel on opposite corner of door. Fasten bracket using same 2 screws in the pre-drilled holes.

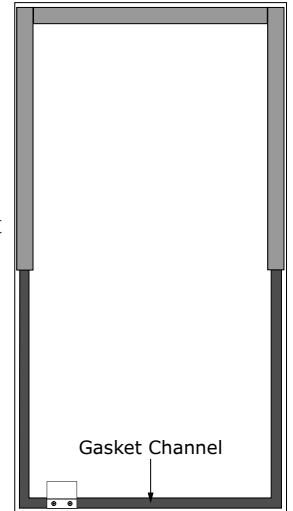
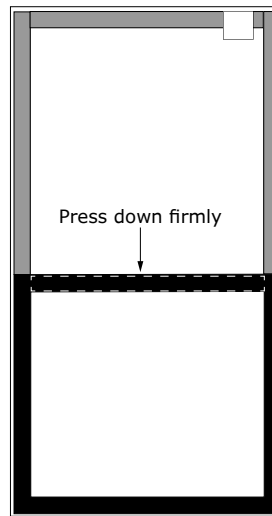

- Install 3 pieces of gasket channel filler into the gasket channel, pressing in firmly.
- Install gasket into channel, beginning at one corner and pressing in firmly.

Note: It may be necessary to apply a strip of two-sided tape for a firm adhesion.

- Press down on middle horizontal portion of gasket until it adheres to the door surface.

Install top hinge and door:

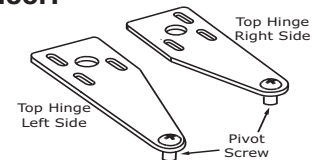

- Remove pivot screw from hinge, flip hinge over, and install the pivot screw in the same hole from the opposite surface.
- Lift the door onto the bottom hinge.
- Align edge of the hinge with the outer edge of the unit.
- Tighten three screws and replace hinge cover.
- Replace hinge cover.

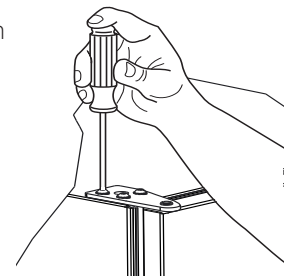

Align and adjust the door:

Align and adjust the door (see DOOR ALIGNMENT AND ADJUSTMENT)

QUICK START GUIDE

General Installation

LEVELING INFORMATION

1. Use a level to confirm the unit is level. Level should be placed along top edge and side edge as shown.

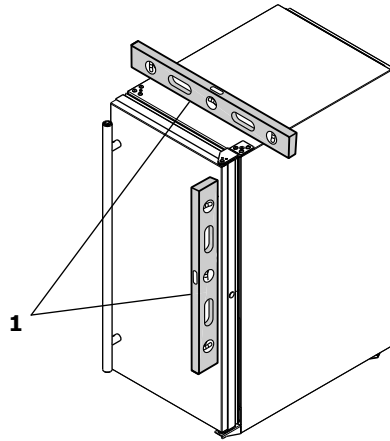

2. If the unit is not level, adjust the legs on the corners of the unit as necessary.

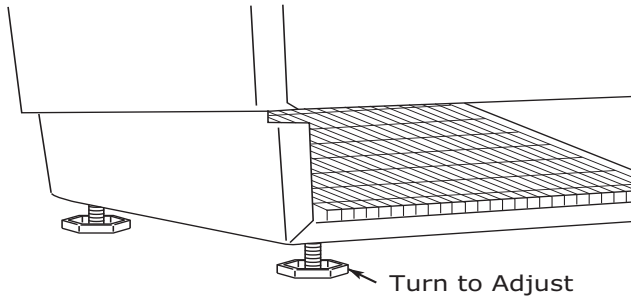

3. Confirm the unit is level after each adjustment and repeat the previous steps until the unit is level.

INSTALLATION TIP

If the room floor is higher than the floor in the cutout opening, adjust the rear legs to achieve a total unit rear height of 1/8" (3 mm) less than the opening's rear height. Shorten the unit height in the front by adjusting the front legs. This allows the unit to be gently tipped into the opening. Readjust the front legs to level the unit after it is correctly positioned in the opening.

INSTALLATION

1. Plug in the power/electrical cord.
2. Gently push the unit into position. Be careful not to entangle the cord or water and drain lines, if applicable.
3. Re-check the leveling, from front to back and side to side. Make any necessary adjustments. The unit's top surface should be approximately 1/8" (3 mm) below the countertop.
4. Install the anti-tip bracket.
5. Remove interior packing material and wipe out the inside of the unit with a clean, water-dampened cloth.

QUICK START GUIDE

Integrated Panel Installation

INTEGRATED MODELS ONLY

1. Fully open door.

2. Starting at corner, pull gasket away from door.

3. Continue to pull gasket free from gasket channel.

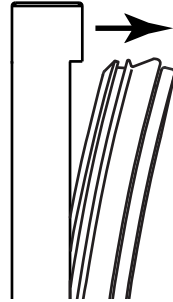

4. Upon removal, lay gasket down on a flat surface.

5. Align top of panel with top edge of door. Center panel on door.

Due to differences in floor construction or surrounding cabinetry, the panel may not sit flush with the top of the door.

6. Secure integrated panel to door using clamps. A robust tape may also be used. U-Line recommends the use of bar clamps to secure the panel to the door. If using tape, be certain the tape will not damage panel finish upon removal.

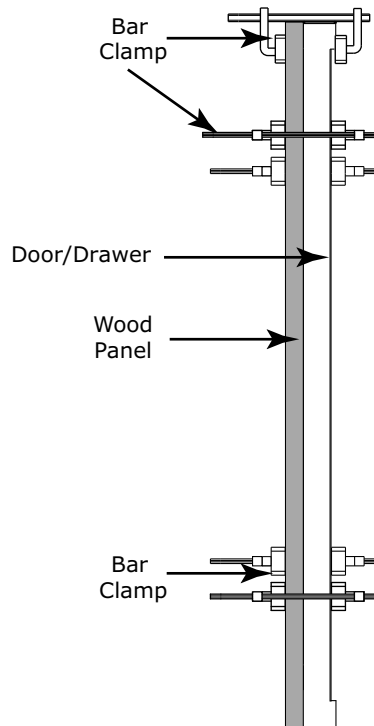

7. Using a 7/64" (3 mm) drill bit, drill 6 pilot holes into the wood panel 1/2" (12 mm) deep using the holes in the door frame as a guide.

It is important to ensure that all drilled holes are drilled to the correct depth in order to avoid splits in the wood when hardwood is installed.

8. Locate 6 of the #6x 1-1/2" (38 mm) screws provided with your unit.

9. Using a Phillips screwdriver, place one screw into each of the 6 pilot holes and screw down. Do not overtighten screws.

10. Ensure the screws sit flush against the bottom of the channel.

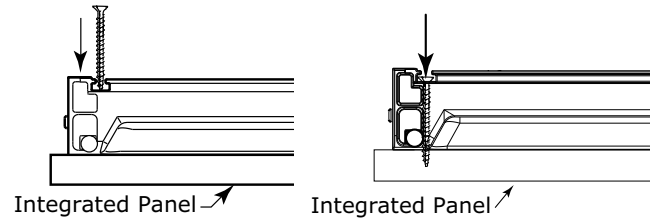

11. Remove clamps from door.

If panel requires additional adjustment after removing clamps, slightly loosen each screw and adjust panel as necessary. Tighten screws upon completion.

12. Starting at the corners, re-install the gasket into the gasket channel in the frame. Make sure the gasket is fully seated.

QUICK START GUIDE

Control Operation

3 CLASS

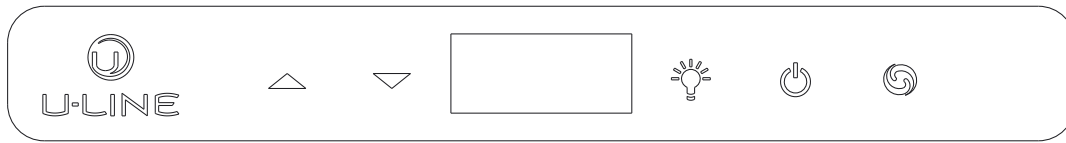

CONTROL FUNCTION GUIDE

FUNCTION	COMMAND	NOTES								
ON/OFF	Press and release	Unit will immediately turn On or OFF								
Adjust ice density	See "Ice" section									
Adjust light color	While holding press and release to scroll through lighting options	<table border="0"> <tr> <td>Option</td> <td>Open Door</td> </tr> <tr> <td>00</td> <td>White</td> </tr> <tr> <td>01</td> <td>Blue</td> </tr> <tr> <td>02</td> <td>White</td> </tr> </table>	Option	Open Door	00	White	01	Blue	02	White
Option	Open Door									
00	White									
01	Blue									
02	White									
Enable Sabbath Mode	Press and hold for 5 seconds and release	The °F / °C symbol will flash briefly after 5 seconds. Interior light and display will go dark and remain so until user resets mode - unit continues to operate								
Disable Sabbath Mode	Press and release	Display and interior light return to normal operation								
Clean Mode	See "Cleaning" section									
Showroom Mode	Hold and for 5 seconds	The °F / °C symbol will flash. Display will be lit and interior light will function. Unit will not cool. Repeat command to return to normal operation								

This unit is Star-K certified. See www.star-k.org for more details.

DOOR ALERT NOTIFICATION

When the door is left open for more than 30 minutes:

- Ice production will cease
- A tone will sound for several seconds every minute
- will appear in display



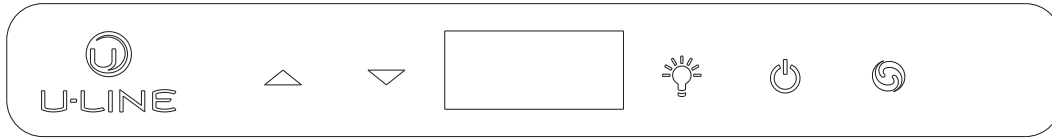

Close door to silence alert and reset (Ice production will resume if bin sensor is not satisfied)

QUICK START GUIDE

1 CLASS & ADA COLLECTION



CONTROL FUNCTION GUIDE

FUNCTION	COMMAND	NOTES
ON/OFF	Press  and release	Unit will immediately turn On or OFF
Adjust ice density	See "Ice" section	
Enable Sabbath Mode	Press  and hold for 5 seconds and release	The °F / °C symbol will flash briefly after 5 seconds. Interior light and display will go dark and remain so until user resets mode - unit continues to operate
Disable Sabbath Mode	Press  and release	Display and interior light return to normal operation
Clean Mode	See "Cleaning" section	
Showroom Mode	Hold  and  for 5 seconds	The °F / °C symbol will flash. Display will be lit and interior light will function. Unit will not cool. Repeat command to return to normal operation

This unit is Star-K certified. See www.star-k.org for more details.

DOOR ALERT NOTIFICATION

When the door is left open for more than 30 minutes:



- Ice production will cease
- A tone will sound for several seconds every minute
-  will appear in display

Close door to silence alert and reset (Ice production will resume if bin sensor is not satisfied)

First Use

Initial startup requires no adjustments. See CONTROL OPERATION section for more details.

U-Line recommends discarding the ice produced during the first two to three hours of operation to avoid possible dirt or scale that may dislodge from the water line.

When plugged in, the unit will begin operating under the factory default settings. If the unit was turned off during installation, simply press  and the unit will immediately switch on. To turn the unit off, press  and release.

QUICK START GUIDE





Ice

The Nugget Ice Machine produces cylindrical bits of compressed ice approximately 3/4" x 1/2".

Ice is produced until the machine senses the bin is full. As ice slowly melts in the bin, the level of ice drops and ice production resumes. This ensures a constant supply of fresh ice is always available.



The factory default ice setting is 0, which produces a firm and compact ice nugget. U-Line's exclusive U-Choose™ ice adjustability feature allows you five levels of adjustment from 0 to -5. At -5 the ice is soft and chewable.

To adjust the ice density:

1. Hold  for 5 seconds - display will flash current ice setting
2. Adjust using  or 
3. Confirm setting by pressing 

Cleaning

NUGGET ICE MACHINE CLEANING CYCLE



This ice machine has an automatic clean alert function. The control will indicate  in the display, reminding you to clean your unit. When  is displayed, ice production will continue. Depending on water conditions, more frequent cleaning may be necessary: see chart below. Cleaning removes lime scale, other mineral deposits, and sanitizes the machine. Poor ice quality and reduced ice output are signs that cleaning is necessary.





BEFORE RUNNING THE CLEANING CYCLE, MEASURE THE TDS (TOTAL DISSOLVED SOLIDS) LEVEL OF YOUR WATER SUPPLY.

(See WATER HOOKUP section in this guide to find instructions for using the TDS meter that was included with this ice machine.)

TDS (Total Dissolved Solids) (ppm)	Cleaning Interval
5 - 150 ppm	6 months
150 - 200 ppm	4 months

Under normal conditions cleaning should be done when the display shows . You may initiate a cleaning cycle at any time by pressing and holding the clean button for 10 seconds.  will appear in the display indicating the start of the cleaning process.

Failure to clean may reduce the quality and quantity of ice produced. Once the clean cycle begins, it can be canceled by pressing  three times. Press  once more to start making ice. The clean cycle will automatically cancel if user fails to activate control at steps 2, 3b, and 5b within 2 hours.

Required for cleaning:

- Clean potable water
- Bucket and cleaning sponge
- Internal water filter (if applicable) — [ULANUGGETFILTER**](#)
- SafeCLEAN Plus™ Cleaner — [ULANUGGETCLEAN**](#)
- Hose (7/16" ID x 9/16" OD) and funnel
 - Register your product at u-line.com and receive a free cleaning kit - [ULANUGGETCLEANKIT**](#) (cleaner, hose, & funnel)

** available for purchase at u-line.com or your local dealer

Need more cleaner? Visit u-line.com



Use only SafeCLEAN Plus™ Cleaner. Use of any other cleaner may damage the finish of the evaporator and will void the warranty.



Follow safety and handling instructions printed on the SafeCLEAN Plus™ bottle.

Notice:





Select models include a water filter. The filter must remain in place when using and cleaning the machine. The filter is designed to filter out scale, sediment, particles and cloudiness as well as reduce chlorine and other off tastes and odors. U-Line recommends replacing the filter (Part No. [ULANUGGETFILTER](#)) when you clean your machine. The filter is available at u-line.com.

QUICK START GUIDE

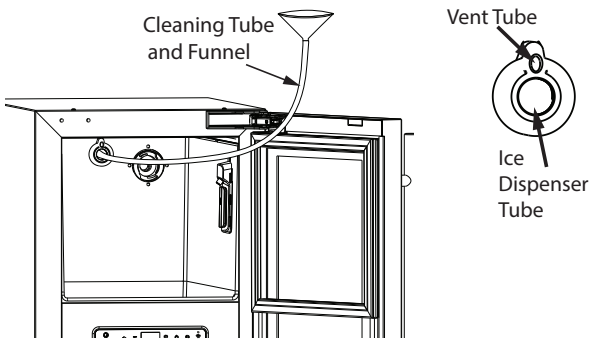



1. Press and Hold  for 10 seconds
 - a.  will appear in the display
 - b. Remove access shield
 - c. Remove all ice in bin
 - d. Remove any ice protruding from the ice dispenser tube.
2. Insert the end of the cleaning tube into the ice dispenser; slowly pour in approximately 1 quart of hot (min. 100° F) potable water. This will melt ice inside the dispenser tube. It is normal for some water to flow from the ice dispenser tube and exit from the vent tube while pouring. Omit this step if no ice is in the ice dispenser tube.

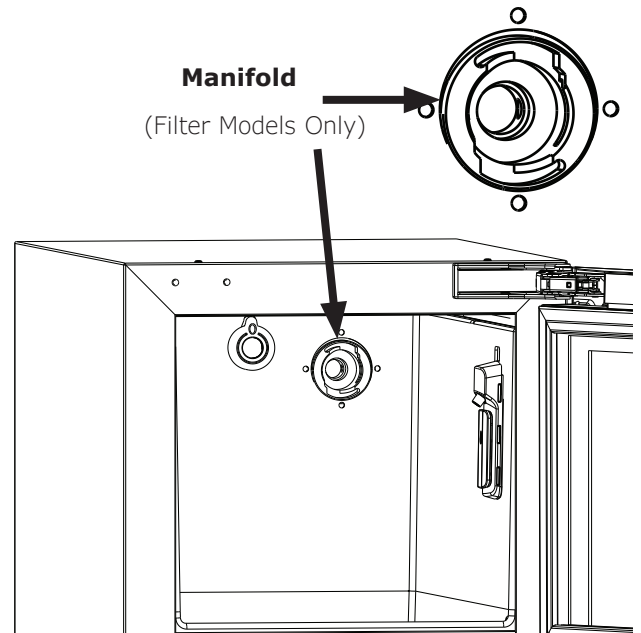

3. Press and release 
 - a.  will appear in the display
 - b. Mix 4 ounces of SafeCLEAN Plus™ with 2 quarts of potable water.
4. Wait until  appears in the display
 - a. Using the funnel and cleaning tube, slowly pour $\frac{3}{4}$ of the cleaning solution into the dispenser tube. Air and some water will exit the vent tube. Remove cleaning tube.
 - b. Press and release 
5.  will appear in the display
 - a. The machine will circulate the solution, cleaning and sanitizing the internal components, for approximately 20 minutes.
 - b. While the machine is circulating the cleaning solution, use $\frac{1}{2}$ of the remaining cleaning solution and a sponge to wipe down the inside of the ice bin and scoop. Rinse with clean potable water.

6. When  appears in the display, 3 soft tones will sound, indicating the cleaning phase is complete
 - a. Remove and discard water filter if applicable by rotating $\frac{1}{4}$ turn counterclockwise.
 - b. Use the remaining cleaning solution to wipe the manifold and surrounding area. Rinse with clean potable water.



7.  will appear in the display
 - a. Reinstall shield and close door.
 - b. The machine will circulate water and perform a series of final rinses for approximately 15 minutes.
 - c. The unit will resume making ice - indicated by 3 soft tones and **ICE** scrolling in the display.
 - d. Discard first 10 minutes of ice production.

U-Line Corporation (U-Line) Limited Warranty

One Year Limited Warranty

For one year from the date of original purchase, this warranty covers all parts and labor to repair or replace any part of the product that proves to be defective in materials or workmanship. For products installed and used for normal residential use, material cosmetic defects are included in this warranty, with coverage limited to 60 days from the date of original purchase. All service provided by U-Line under the above warranty must be performed by a U-Line factory authorized servicer, unless otherwise specified by U-Line. Service provided during normal business hours.

Two Year Limited Warranty (5 Class Product)

For two years from the date of original purchase, this warranty covers all parts and labor to repair or replace any part of the product that proves to be defective in materials or workmanship. For products installed and used for normal residential use, material cosmetic defects are included in this warranty, with coverage limited to 60 days from the date of original purchase. All service provided by U-Line under the above warranty must be performed by a U-Line factory authorized servicer, unless otherwise specified by U-Line. Service provided during normal business hours.

Available Second & Third Year Limited Warranty

In addition to the standard one and two year warranties outlined above, U-Line offers a one year extension of the warranties from the date of purchase, free of charge. To take advantage of this extension, you must register your product with U-Line within 60 days from the date of purchase at u-line.com and provide proof of purchase. Nugget Ice Machine proof of purchase must include the purchase of an in-line water filter and filter head to qualify for this additional limited warranty.

Five Year Sealed System Limited Warranty

For five years from the date of original purchase, U-Line will repair or replace the following parts, labor not included, that prove to be defective in materials or workmanship: compressor, condenser, evaporator, drier, and all connecting tubing. All service provided by U-Line under the above warranty must be performed by a U-Line factory authorized servicer, unless otherwise specified by U-Line. Service provided during normal business hours.

Terms

These warranties apply only to products installed in any one of the fifty states of the United States, the District of Columbia, or the ten provinces of Canada. The warranties do not cover any parts or labor to correct any defect caused by negligence, accident or improper use, maintenance, installation, service, repair, acts of God, fire, flood or other natural disasters. The product must be installed, operated, and maintained in accordance with your product's User Guide.

The remedies described above for each warranty are the only ones that U-Line will provide, either under these warranties or under any warranty arising by operation of law. U-Line will not be responsible for any consequential or incidental damages arising from the breach of these warranties or any other warranty, whether express, implied, or statutory. Some states do not allow the exclusion or limitation of incidental or consequential damages, so the above limitation or exclusion may not apply to you. These warranties give you specific legal rights, and you may also have other rights which vary from state to state.

Any warranty that may be implied in connection with your purchase or use of the product, including any warranty of *merchantability* or any warranty *fit for a particular purpose* is limited to the duration of these warranties, and only extends to five years in duration for the parts described in the section related to the five year limited warranty above. Some states do not allow limitations on how long an implied warranty lasts, so the above limitations may not apply to you.

- The warranties only apply to the original purchaser and are non-transferable.
- The second, third, and five year warranties cover products installed and used for normal residential or designated marine use only.
- The warranties apply to units operated outside only if designed for outdoor use by model and serial number.
- U-Line Commercial products are covered by the one year and 5 year limited warranties and are not eligible for the second and third year limited warranties.
- Replacement water filters, light bulbs, and other consumable parts are not covered by these warranties.
- The start of U-Line's obligation is limited to four years after the shipment date from U-Line.
- In-home instruction on how to use your product is not covered by these warranties.
- Food, beverage, and medicine loss are not covered by these warranties.
- If the product is located in an area where U-Line factory authorized service is not available, you may be responsible for a trip charge or you may be required to bring the product to a U-Line factory authorized service location at your own cost and expense.
- Units purchased after use as floor displays, and/or certified reconditioned units, are covered by the limited one year warranty only and no coverage is provided for cosmetic defects.
- Signal issues related to Wi-Fi connectivity are not covered by these warranties.

For parts and service assistance, or to find U-Line factory authorized service near you, contact U-Line:
8900 N. 55th Street, Milwaukee, WI 53223 • u-line.com • onlineservice@u-line.com • +1.414.354.0300