



KODIAK

—
Operating Instructions



KODIAK10



Varimixer

Varimixer USA
2215 East River Road P: (800) 222-1138
Moraine, Ohio 45439 varimixerusa.com

EN

DRN: 20010-1636
2022 01 12

Limited Mixer Warranty - 10 qt to 150 qt

VARIMIXER warrants to the original purchaser of new equipment that said equipment, when installed in accordance with our instructions within North America and subjected to normal use, is free from defects in material or workmanship for a period of 4 years. Wear parts, such as belts, are excluded. Hub attachments, such as shredders, slicers and grinders have a 1 year warranty that only covers parts. Warranty begins on date of factory shipment to an end user, or up to 6 months after factory shipment to a dealer or distributor. Payment by VARIMIXER for service under this warranty requires that service be authorized in advance. Contact VARIMIXER Technical Support to arrange for service.

THIS WARRANTY IS IN LIEU OF ALL OTHER WARRANTIES, WHETHER EXPRESSED OR IMPLIED. VARIMIXER EXPRESSLY DISCLAIMS ANY IMPLIED WARRANTY OF MERCHANTABILITY OR EXPRESSED OR IMPLIED WARRANTY OF FITNESS FOR A PARTICULAR PURPOSE.

VARIMIXER'S OBLIGATION AND LIABILITY UNDER THIS WARRANTY IS EXPRESSLY LIMITED TO REPAIRING AND REPLACING EQUIPMENT WHICH PROVES TO BE DEFECTIVE IN MATERIAL OR WORKMANSHIP WITHIN THE APPLICABLE WARRANTY PERIOD. All repairs pursuant to this Warranty will be performed by an Authorized Designated VARIMIXER Service Location during normal working hours. IN NO EVENT SHALL VARIMIXER BE LIABLE FOR INCIDENTAL OR CONSEQUENTIAL DAMAGES TO BUYER OR ANY THIRD PARTY, INCLUDING, WITHOUT LIMITATION, LOSS OF PROPERTY, PERSONAL INJURY, LOSS OF BUSINESS OR PROFITS OR OTHER ECONOMIC LOSSES, OR STATUTORY OR EXEMPLARY DAMAGES, WHETHER IN NEGLIGENCE, WARRANTY, STRICT LIABILITY, OR OTHERWISE.

This warranty is given only to the first purchaser from a retail dealer. No warranty is given to subsequent transferees.

This warranty does not cover product failures caused by: failure to maintain, neglect, abuse, damage due to excess water, fire, normal wear, improper set up and use. Periodic maintenance is not covered.

Example of items not covered under warranty, but not limited to just these items:

1. Acts of God, fire, water damage, vandalism, accident, theft.
2. Freight damage.
3. Improper installation or alteration of equipment.
4. Use of generic or after market parts.
5. Repairs made by anyone other than a VARIMIXER designated servicer.
6. Lubrication.
7. Expendable wear parts. (This includes the bowl, flat beater, wire whip, spiral dough hook, and the pastry knife.)
8. Cleaning of equipment.
9. Misuse or abuse.

This warranty is not in force until such time as a properly completed, digitally signed Installation/Warranty Registration has been received by VARIMIXER within 30 days from the date of installation. Register online at www.varimixerusa.com/support/warranty-registration-form.

THE FOREGOING WARRANTY PROVISIONS ARE A COMPLETE AND EXCLUSIVE STATEMENT BETWEEN THE BUYER AND SELLER. VARIMIXER NEITHER ASSUMES NOR AUTHORIZES ANY PERSONS TO ASSUME FOR IT ANY OTHER OBLIGATION OR LIABILITY IN CONNECTION WITH SAID EQUIPMENT.

WARRANTY REGISTRATION
GO TO VARIMIXERUSA.COM
TO FILL OUT AND SUBMIT YOUR WARRANTY REGISTRATION.
VARIMIXERUSA.COM/SUPPORT/WARRANTY-REGISTRATION-FORM

Caution -READ BEFORE OPERATING- Caution

Varimixer recommends that mixer operators must be at least 18 years of age and be thoroughly trained on the use, cleaning and lubrication of the mixer.

This manual should be seen as an integral part of the mixer and should be kept by the machine throughout its working life.

Before the machine is commissioned, it is important to read these instructions thoroughly.

The manufacturer may update the product manual without updating this copy of the manual.

Varimixer recommends that the following precautions be adopted to help make the mixer operation safer and more efficient.

- All operators must be at least 18 years of age.
- All operators must be thoroughly trained before being allowed to operate the mixer.
- NEVER reach into the bowl when the mixer is running.
- Do not wear loose clothing or rings while operating the mixer.
- Stop the mixer and lower the bowl before adding ingredients, scraping the bowl, removing the agitator, or removing the product.
- Stop the mixer before removing or installing attachments into the drive hub.
- Do not attempt to assemble or disassemble attachments while mounted into the drive hub.
- Always use the pusher plate with the slicer/meat grinder attachments.
- NEVER bypass the safety mechanisms supplied on the mixer. Doing so can cause injury and is the responsibility of the user to ensure these safety mechanisms are operating properly.

CONTENTS:

GENERAL:

UNPACKING:	4
TRANSPORT:	5
INSTALLATION AND ADJUSTMENTS:	5
ELECTRICAL CONNECTION:	5
SAFETY:	6
MAGNETS	6
COMMISSIONING:	7
USE OF THE MACHINE:	7
TECHNICAL DATA:	7
COMPONENTS OF THE MACHINE:	8
KODIAK USER-FRIENDLINESS:	9
MAX. CAPACITY OF THE MACHINE:	10
CORRECT USE OF TOOLS:	10
ATTACHMENT DRIVE:	10
OPERATING THE MIXER:	11
CLEANING:	12
REPAIR AND MAINTENANCE	12
SYSTEMATIC MAINTENANCE:	13
OVERLOADING:	14
READING THE MACHINES DATA:	14
READING THE ERROR LOG:	14
ERROR CODES AND POSSIBLE SOLUTIONS:	15
CIRCUIT DIAGRAM:	16

GENERAL:

This manual should be seen as an integral part of the machine and should be kept by the machine throughout its working life.

Before the machine is commissioned, it is important to read these instructions thoroughly, particularly the section on user safety.

The manufacturer may update the product manual without updating this copy of the manual.

The manufacturer will not be liable for faults caused by:

- Careless, improper or incorrect use of the machine
- Non-standard use (not for the purposes described in the manual)
- Incorrect installation
- Incorrect power supply to the machine
- Failure to comply with maintenance instructions
- Modifications to the machine
- Spare parts and accessories that are not original or specified for this model
- Failure to comply with instructions in this manual

In case of faults with the machine, please contact the supplier.

The guarantee does not cover damage caused by misuse, overloading or the user's failure to comply with the maintenance instructions.

UNPACKING:

The machine should be unpacked and the packaging disposed of according to regulations applicable in the country concerned.

Before the machine is removed from the pallet, check that all parts are present with the machine:

- Safety guard
- 1.26" fixed spanner for legs.
- Bowl, whip, beater, dough hook and scraper with blade.

The machine can be released from the pallet by cutting the strips.

TRANSPORT:

Lifting equipment should always be used to move the machine.

The machine must not be pulled or lifted by the bowl lift handle.

When the machine is moved, it should be in a vertical position at all times.

INSTALLATION AND ADJUSTMENTS:

The ambient temperature around the machine must not exceed 45°C.

Level the machine by adjusting the feet, using the supplied 32 mm fixed spanner.

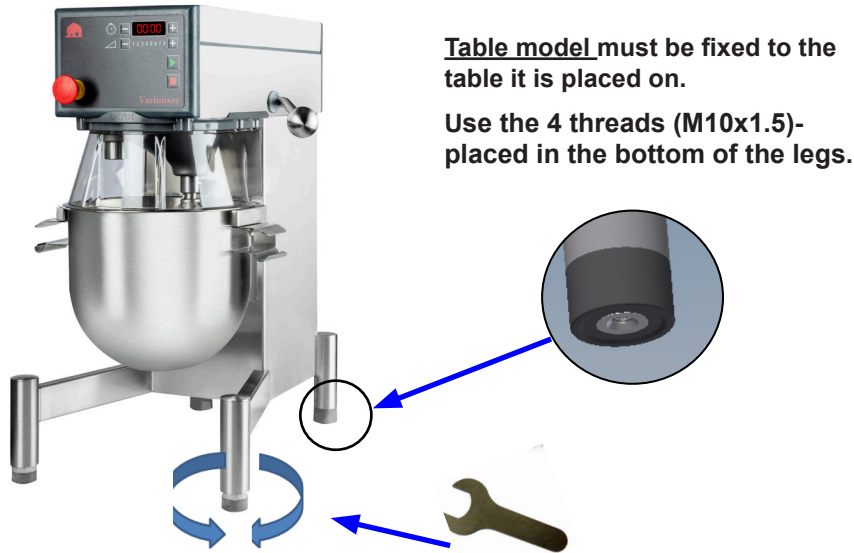
**ELECTRICAL CONNECTION:**

Before the machine is connected to the mains, control that the voltage and frequency printed on the name plate correspond with the installation location.

The name plate is positioned uppermost on the back of the machine.

The electrical installation circuit must be secured by a Residual Current Device:

RCD type A-SI

The mixer must be earthed. Failure to do so may cause -

Risk of electrical shock.

Damage to the machine.

Excessive electromagnetic noise, causing malfunction to the machine and interference to other devices.

User can connect machine if -

Cable with plug is delivered with the machine

Only certified electrician must connect the machine, if fixed cable without a plug is delivered with the machine

For the benefit of service staff, it should be clear to see when the mains plug to the mixer has been removed from the socket in the wall.

SAFETY:

User safety is assured as follows:

The mixer is designed for commercial use in kitchens, catering outlets and bakeries.

The machine is designed for the manufacture of products that do not trigger any reactions or release substances that may be harmful to the user when in use.

The machine must not be used in an explosive atmosphere.

The machine may only be used by trained personnel.

Always comply with local laws and regulations with special attention to operators age, physical and mental condition. Operator must be over 14 years of age.

The constant noise level of the workplace of the operator is lower than 70 dB (A)

Tools can only rotate when the safety guard is in place and the bowl is lifted (bowl detection).

The safety guard is made of plastic.

It is not possible to attach the guard incorrectly.

No access to rotating tools.

The spread of flour dust is inhibited.

Equipped with emergency stop - The tool stops rotating in less than 4 seconds (also for normal shut-down and stop via safety guard).

Clearance between guard/stand and lifting handle at least 2".

Machine remains stable even if tilted of up to 10°.

The machine is protected against overvoltage.

Non-ionising radiation is not produced intentionally, but rather technically conditioned by electrical equipment (e.g. electric motors, live power lines or solenoids). The machine is equipped with strong permanent magnets. By maintaining a safe distance (between the field source and implant) of 12" any impact on active implants (e.g. pacemakers, defibrillators) can likely be prevented.

**MAGNETS:**

**Warning for users with implants (e.g. pacemakers, defibrillators).
machine and safety guard equipped with strong magnets**

Area on safety guard with magnets



Area on machine with magnets - for safety guard switch

Areas on machine and bowl with magnets - for bowl detection

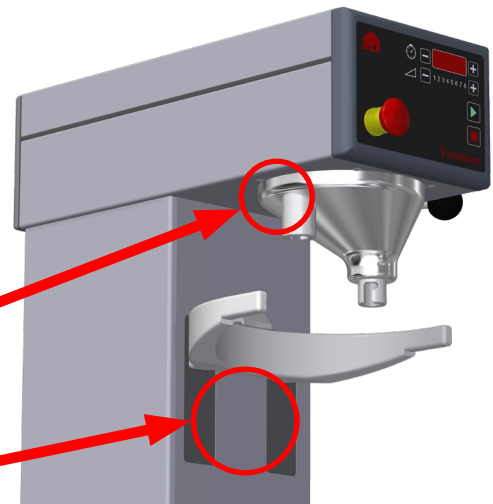

COMMISSIONING:

Bowl, tools and safety guard should be cleaned before use – see section on **Cleaning, page 10**.

The machine should be positioned to allow space for normal use and maintenance..

USE OF THE MACHINE:

The machine may only be used as specified in this manual.

Only bowls designed for Kodiak may be used.

Keep hands out of the bowl while the machine is running, can cause severe injury.

Unless the change is recommended by the manufacturer, modifying the machine is prohibited.

The following recommendations apply to work with powdery ingredients:

- Powdery ingredients should not be poured into the bowl from a great height.
- Bags of e.g. flour should be opened at the bottom and down in the bowl.

TECHNICAL DATA:

Kodiak 10	Gross weight	Net weight	Power	Variable speed, tool
Model	lbs	lbs	hp	rpm
Floor model	304	264	1	72 - 451
Table model	138	110		

Floor model:

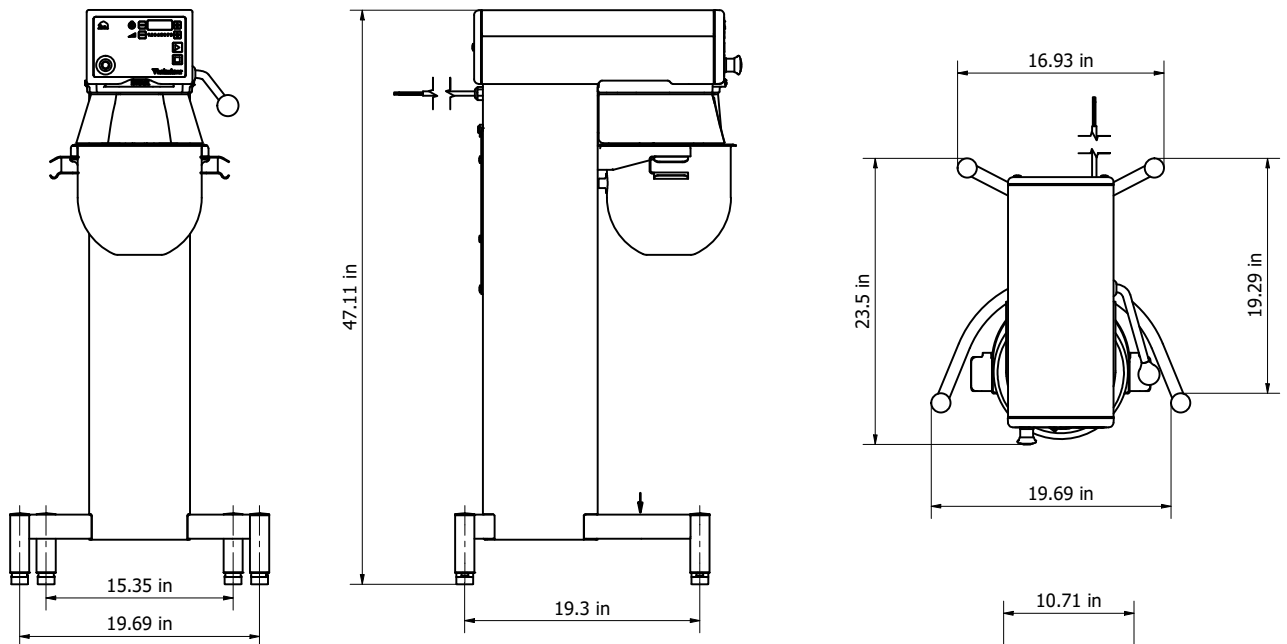
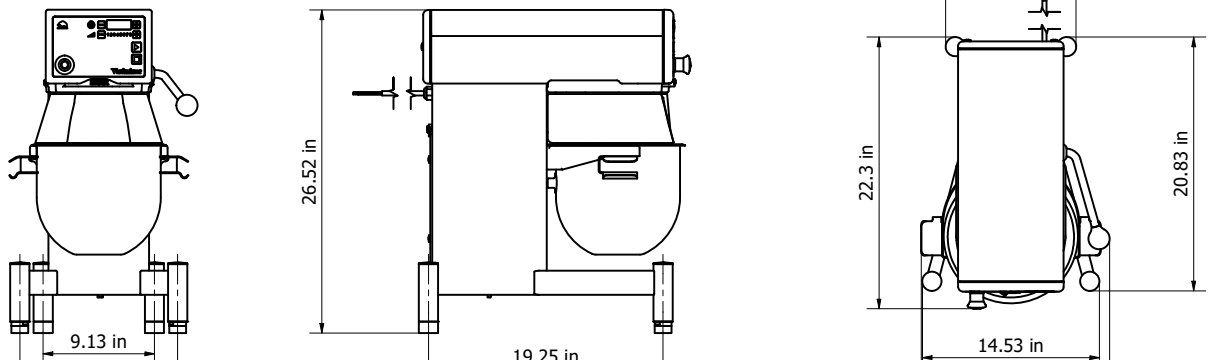

Table model:



COMPONENTS OF THE MACHINE:



The bowl must be pushed all the way into the bowl arms.

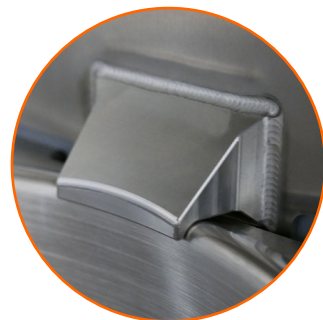

When lifted, the bowl should be fixed underneath the bowl fitting

KODIAK USER-FRIENDLINESS:

KODIAK has been designed in partnership with kitchen and bakery staff, which has resulted in a number of user benefits:

The machine itself

Can be connected to the mains by the user (standard voltage)

Is made of stainless steel

Has height-adjustable feet to ensure stability even on sloped area

Is easy to clean, with large surfaces and a removable safety guard which can be machine-washed

The control panel combined with the large bowl diameter provides a good view of the contents of the bowl.

Control panel:

The control panel is simple and intuitive, with large push buttons.

The panel is easy to clean with a damp cloth.

There is a built-in timer function with a display, which can also be used to show the number of operating hours.

Bowl.

The bowl is not very deep but has a large diameter, which makes it easier to see the contents while working.

Safety guard:

The one-piece safety guard is made of transparent plastic. The guard is easy to remove and clean.

The guard can be machine washed at up to 140° F and can withstand up to 194°F for short periods.

The guard is made of a special impact resistant material which can withstand daily use in a commercial kitchen.

The safety guard is held in place by magnets.

It is not possible to attach the guard incorrectly.

The arrows indicate the force required to remove the screen:



MAX. CAPACITY OF THE MACHINE:

Capacities per mix	Tool	
Egg white	Whip	0.5 qt
Whipped cream	Whip	2.5 qt
Mayonnaise *	Whip	8 qt
Mashed potatoes *	Beater/Whip	8.8 lbs
Bread dough (50%AR) **	Hook	11 lbs
Bread dough (60%AR)	Hook	11 lbs
Muffins *	Beater	11 lbs
Meatball mix *	Beater	13 lbs

AR = Absorption Ratio

(Liquid in % of solids)

Calculation AR

1 lbs of solids and 0,6 lbs of liquid:

$$AR = \frac{0,6 \times 100}{1} = 60\%$$

Calculation Solids and Liquid11 lbs Dough, 60% AR
(table, maximum capacity)

$$Solid = \frac{Max. capacity \times 100}{AR + 100}$$

$$= \frac{11 lbs \times 100}{60 + 100} = 6.875 lbs$$

$$Liquid = 11 lbs - 6,75 lbs = 4,125 lbs$$

EQUIPMENT:**Standard equipment, as follows:**

Bowl

Hook, whip, beater, scraper with standard blade

Optional accessories:Scraper blade for high temperature products
(PTFE)

Tool rack

**CORRECT USE OF TOOLS:**

Recommended uses of tool:

Whip	Beater	Hook
Cream	Cake mix	Bread dough
Egg whites	Buttercream	Rye bread
Mayonnaise	Waffle mix	etc.
etc.	Forcemeat	
	etc.	



The whip should not be struck against hard objects such as the edge of the bowl. This will shorten the life of the tool because of increasing deformation.

To make mashed potato, use the beater and then the standard whip.

ATTACHMENT DRIVE:

The machine may be fitted with an attachment drive into which optional accessories, such as meat mincers and vegetable cutters, can be attached.

For further information on the assembly and use of optional accessories, please refer to the manual that comes with the accessory.

The machine must be shut down when the accessory is fitted to the attachment drive.

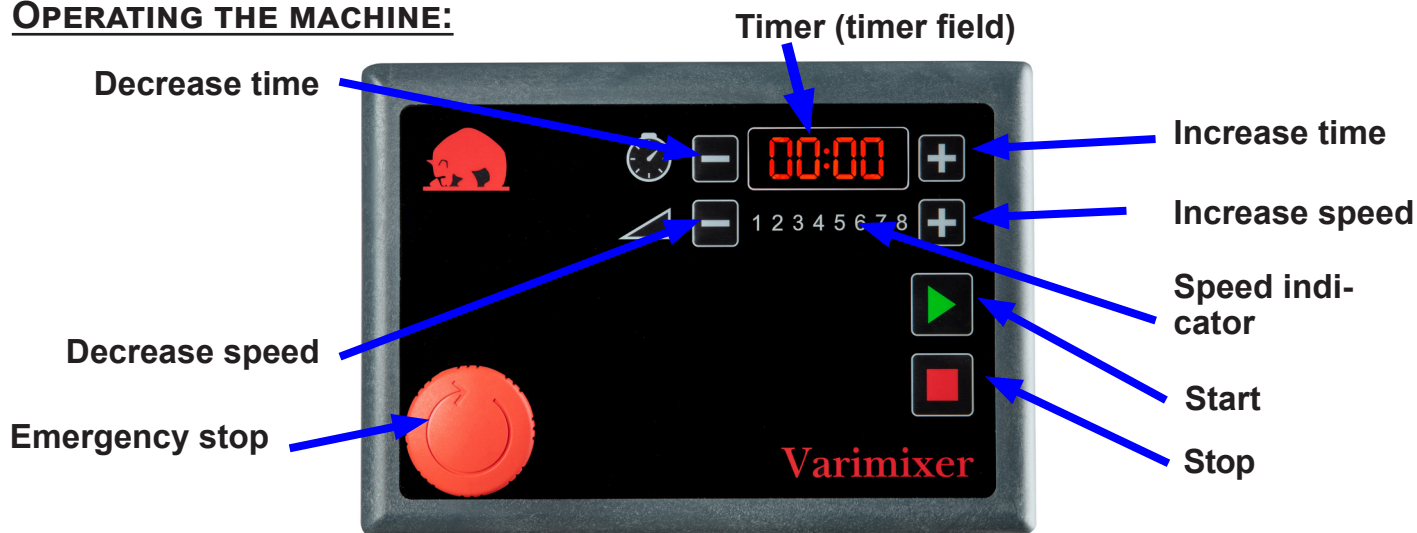
OPERATING THE MACHINE:**Before starting the machine:**

Put the desired tool into the bowl and place the bowl in the bowl arms.

Turn the tool to lock it into the bayonet fitting.

Fit the safety guard.

Lift the bowl with the aid of the lifting handle.

The mixer is now ready to start.

It is possible to set both the running time and speed before starting the machine; see next section:

Start the machine:

Press to start the mixer.

Press next to to increase the speed.

Press next to to reduce the speed.

The speed is shown as a number on the scale 12345678.

The display **12345678** represents the lowest speed, approx. 72 rpm.

The display **12345678** represents the highest speed, approx. 450 rpm.

If a specific start speed is wanted, you set the speed and then start the mixer by pressing .

Display of running time – Timer function:

Select a running time for the mixer by pressing next to . The running time is shown in minutes and seconds in the timer field between and .

Running times of up to 90 minutes are available.

When the mixer is running, the running time will not be reset if is pressed once; press once more and it will be reset.

If no running time is selected, the display will show the time elapsed since the mixer was started.

If the time set on the timer runs out while the mixer is running, the mixer stops and you hear a bib.

Inspection of ingredients while in use:

If the mixer needs to be stopped temporarily without affecting the running time, press . The mixer will slow down and then stop and the running time will stop too.

The bowl can now be lowered and the ingredients checked.

Lift the bowl and press , and the mixer will start and the running time will resume.

Stop the machine:

To stop the machine:

- Press . Running time not reset.
- Press twice. Running time reset.

Restart by pressing .

It will start at the lowest speed.



The emergency stop - only to be used in emergency situations and for powering off the mixer

CLEANING:

The machine may only be cleaned by trained staff and must be over 14 years of age.

Before any cleaning unplug the machine to prevent electrical hazards and accidental start of the machine.

The machine should be cleaned daily after use.

Remove tools, bowl and front and rear guards.



It should be wiped with a soft brush and clean water. Sulphonated soaps should be used with care, as they destroy the lubricants in the machine.

The machine should never be rinsed with a hose.

Bowl, tools and guards are dishwasher-safe.

Plastic safety guard may be damaged if exposed to high temperatures for a prolonged period.
(General maximum temperature 140°F, flush maximum 194°F, for maximum 30 seconds).

REPAIR AND MAINTENANCE

Only to be carried out by qualified and trained staff.

The lid of the mixer may only be removed when the cable to the mains supply has been removed.

LUBRICATION

Lubrication is only needed during repair



Mixer head: gear wheel, needle bearings and internal gear lubricated with **Molykote G-1502 FM**.

Attachment drive (if supplied): gear wheel lubricated with **Renolit GreaseWay LiCa 80**.

Do not use any other grease types than specified.

The moving parts that belong to the bowl's lifting mechanism all run in maintenance-free bearings and should therefore not be lubricated.

SYSTEMATIC MAINTENANCE:

Part	Action	Frequency	Note
Safety guard	Check the safety of the safety guard: Does the tool stop rotating, when the safety guard is not positioned correctly?	Regularly	<p> If the tool does not immediately stop rotating when the safety guard is not positioned correctly, the machine must not be used.</p> <p>Call the engineer</p>
Emergency stop	Test the emergency stop: Does the tool stop rotating when the emergency stop is activated	Regularly	<p> If the tool does not immediately stop rotating on activation of the emergency stop, the machine must not be used.</p> <p>Call the engineer</p>
Attachment drive	The rubber plug for covering the opening of the attachment drive should be on the machine and be intact.	Daily	<p> The rubber plug must cover the opening on the attachment drive when the latter is not in use.</p>
Cleaning	Follow the instructions in the section “Cleaning”	Follow the instructions in the section “Cleaning”	

OVERLOADING:

Always avoid overloading the machine.

Overloading will cause the frequency converter to stop the machine.

OL:1, **OL:2** or **OL:3**

will be displayed in the timer field.

PROCEDURE IN CASE OF OVERLOADING:

Check error code below and follow the suggestion for solution.

When done, remove the error code by pressing .

The machine can now be restarted by pressing .







READING THE MACHINES DATA:

Press the stop button for 5 sec. The machine's data will then be displayed as alternating text in the display. There are five readings corresponding to the five data sets described below:

- **Data set 1:** States firmware version, displayed as "F" followed by three figures, e.g. **F003** = firmware version 3.
- **Data set 2:** States the machine's running time, displayed as "t" followed by three figures, which indicate the number of 9.999-minute cycles, e.g. **t002** = 2 x 9.999 min., or 19.998 min.
- **Data set 3:** Displays four figures, which indicate the number of minutes the current cycle has been running, e.g. **1234** = 1.234 min. I.e., if **t002** is displayed followed by **1234**, the machine has been running for 19.998 min. + 1.234 min., or a total running time of 21.232 min.
- **Data set 4:** States the number of times the machine has been disconnected from the power supply (plug pulled out of the machine/powercut/switched off) and restarted, displayed as "r" followed by three figures, which indicate the number of restarts, e.g. **r002** = 2 x 9,999 restarts, or 19,998 restarts.
- **Data set 5:** Displays four figures, which indicate the number of restarts which have happened in the current cycle, e.g. **1234** = 1234 times. In other words, if **r002** is displayed followed by **1234**, the machine has restarted a total of 19,998 + 1,234 times, or 21,232 times.

READING THE ERROR LOG:

It is possible to display a log of the errors that have occurred:

- Hit emergency stop and press  next to .
- The display shows the latest error first.
- To scroll back through the errors, press  next to ; to scroll forward, press  next to .
- The last eight errors can be displayed.
- Deactivate emergency stop to cancel the display

ERROR CODES AND POSSIBLE SOLUTIONS:

For some errors, the control system will show an error code in the display:

EE: 1 User pressed  without raising the bowl to working height.

Solution: Raise bowl to working height.

EE: 2 User pressed  without fitting the safety guard.

Solution: Fit the safety guard.

EE: 4 The Thermal sensor in the motor has overheated.

Solution: The error will disappear when the temperature has dropped to an acceptable level.

Stop the machine and reduce the quantity of ingredients in the bowl. When it starts again, select a lower speed.

EE: 6 There is an error in communication between the control panel and the frequency converter.

Solution: Call the engineer.

EE: 7 Error in frequency converter.

Solution: Call the engineer.

EE: 8 Thermal sensor in the frequency converter has cut out.

Solution: The error will disappear when the temperature has dropped to an acceptable level.

EE: 9 Intermittent low voltage in the power supply.

Solution: The power supply to the machine should be checked by an expert.

EE: 10 Intermittent high voltage in the power supply.

Solution: The power supply to the machine should be checked by an expert.

EE:14 [EE:14] Wrong parameter in frequency converter

Solution: Call the engineer, reference - Varimixer instruction 23020-1602

OL:1 The machine is overloaded - continuously for 50 seconds.

Solution: Reduce the quantity in the bowl; alternatively, the product may need to be divided into smaller parts or diluted before the machine is restarted. When restarted, select a lower speed, if speed was the problem.

The error code is removed by pressing 

OL:2 The machine is overloaded - momentarily (overloaded 8 times within 20 seconds).

Solution: Reduce the quantity in the bowl; alternatively, the product may need to be divided into smaller parts or diluted before the machine is restarted. When restarted, select a lower speed, if speed was the problem.

The error code is removed by pressing 

OL:3 Blockage.

Solution: Remove the object that caused the blockage.

The error code is removed by pressing 

OL:1, **OL:2** and **OL:3** can also occur when using the attachment drive.

CIRCUIT DIAGRAM: 110-230V

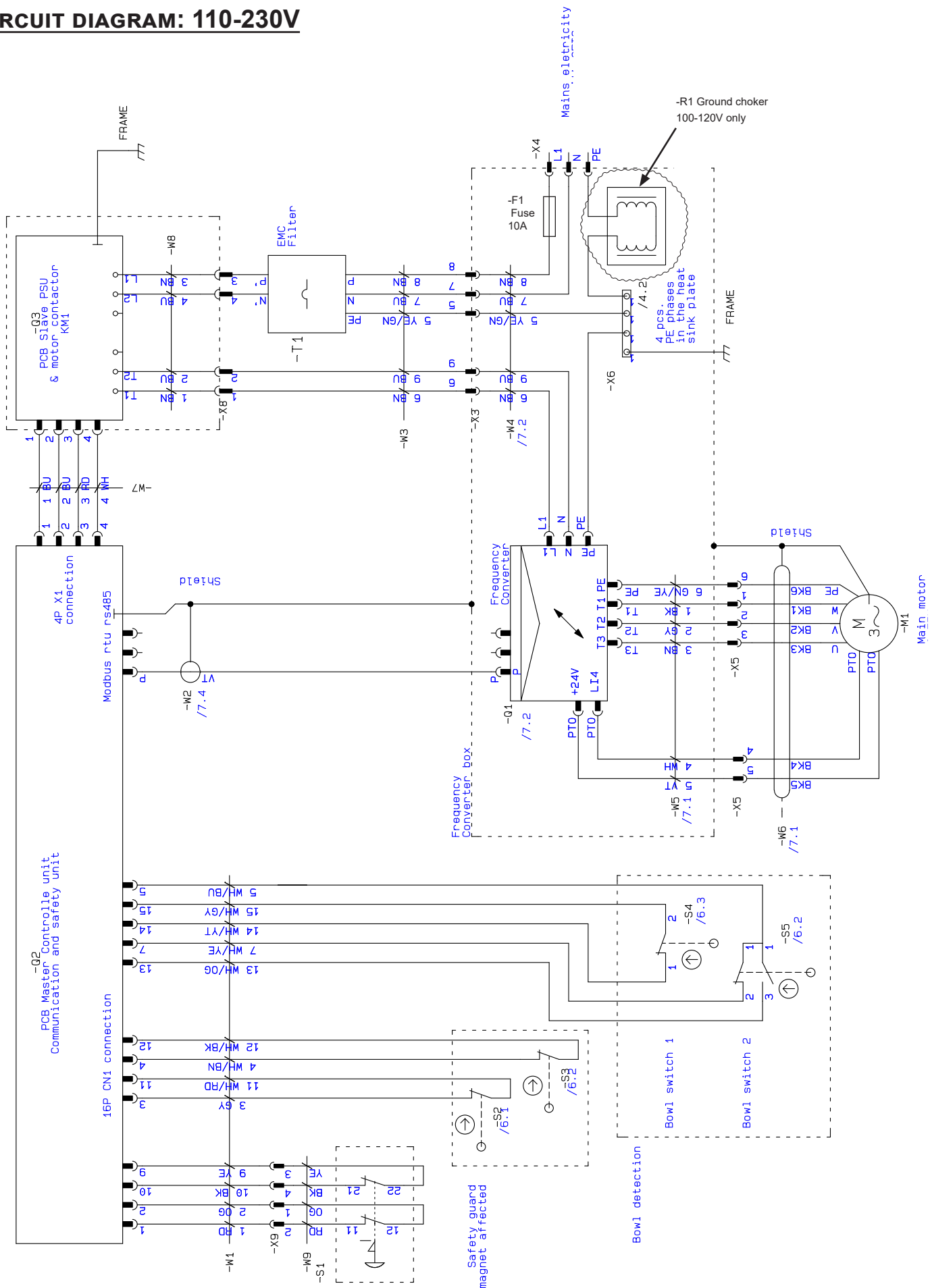

This page intentionally left blank

This page intentionally left blank

This page intentionally left blank



Varimixer

Varimixer USA
2215 East River Road
Moraine, Ohio 45439
P: (800) 222-1138
varimixerusa.com