

FIELD DISCONNECT
(SUPPLIED BY CUSTOMER)

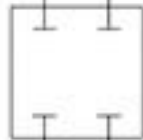

FIELD DISCONNECT
(SUPPLIED BY CUSTOMER)

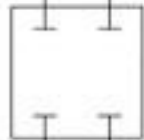

CONDENSER CONTROL PANEL

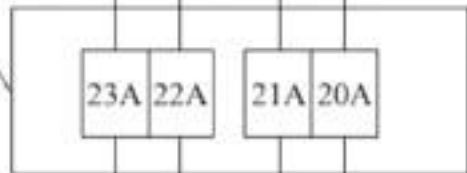

1-phase Motors

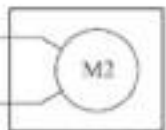

CONDENSER FAN MOTOR #2

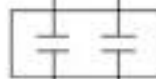

CONDENSER FAN MOTOR #1

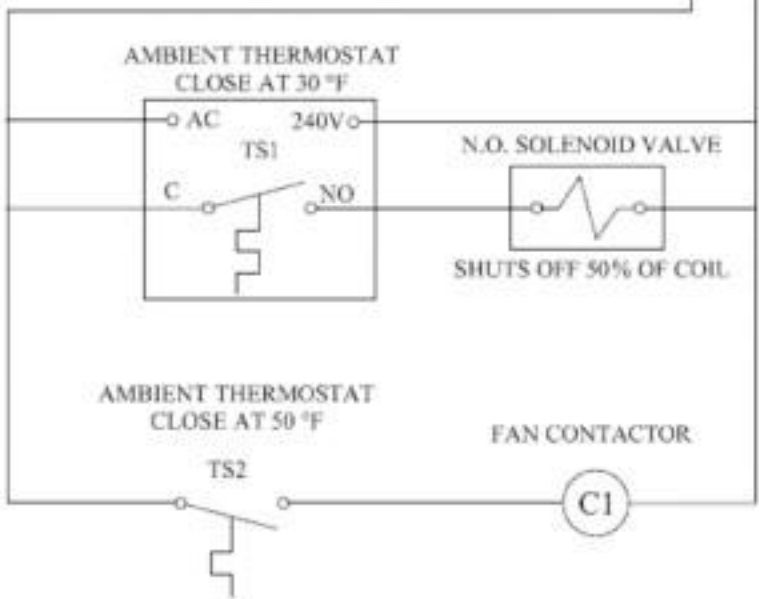

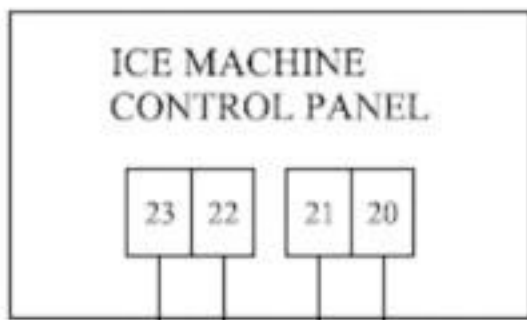

FIELD DISCONNECT
(SUPPLIED BY CUSTOMER)

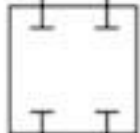

FIELD DISCONNECT
(SUPPLIED BY CUSTOMER)

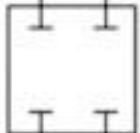

CONDENSER CONTROL PANEL

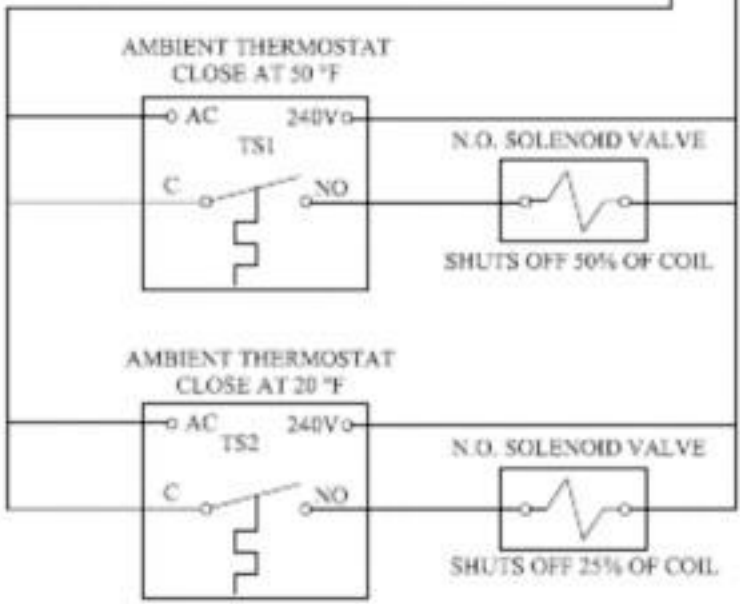

1-phase Motor

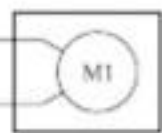

CONDENSER FAN MOTOR #1

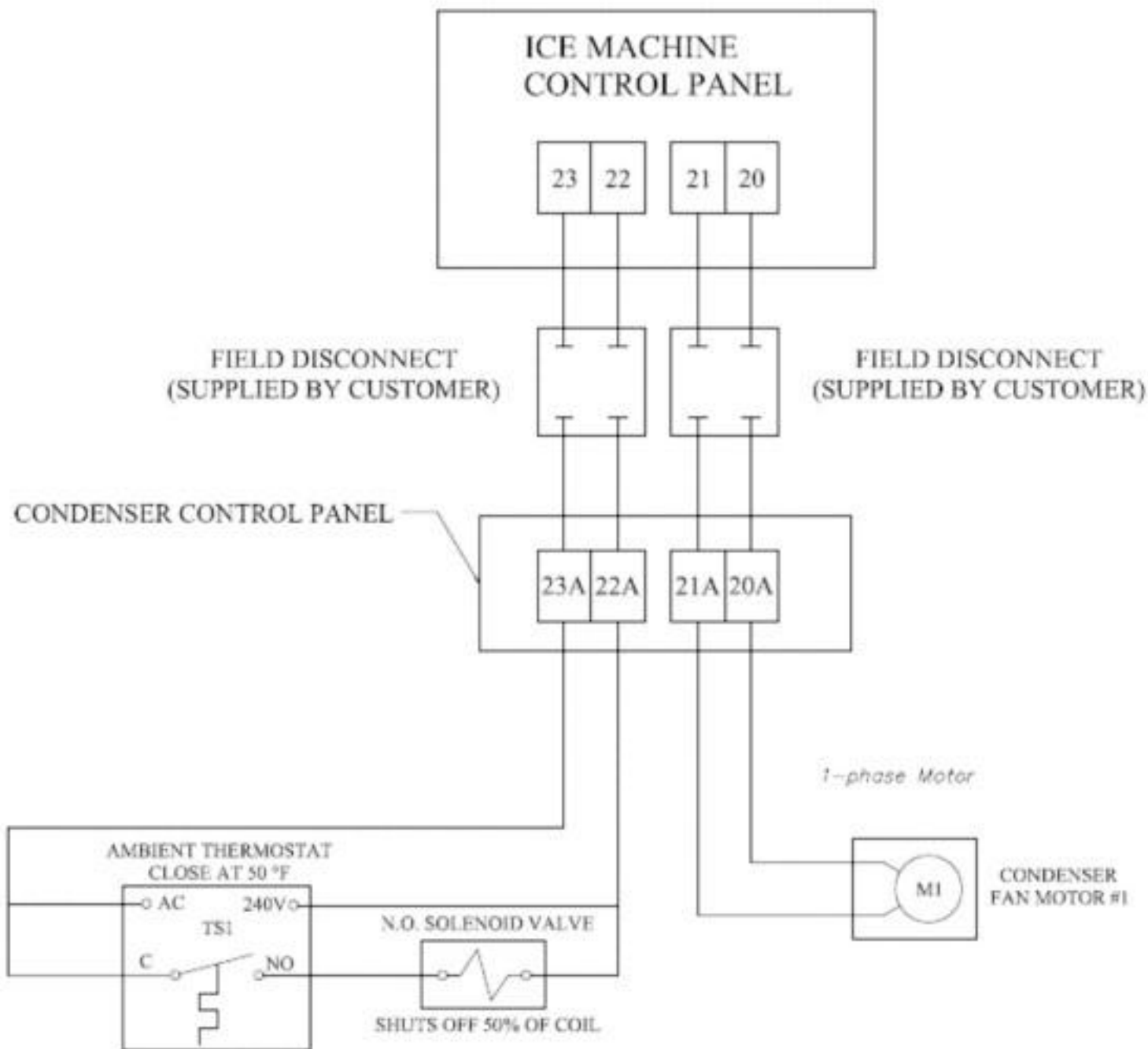

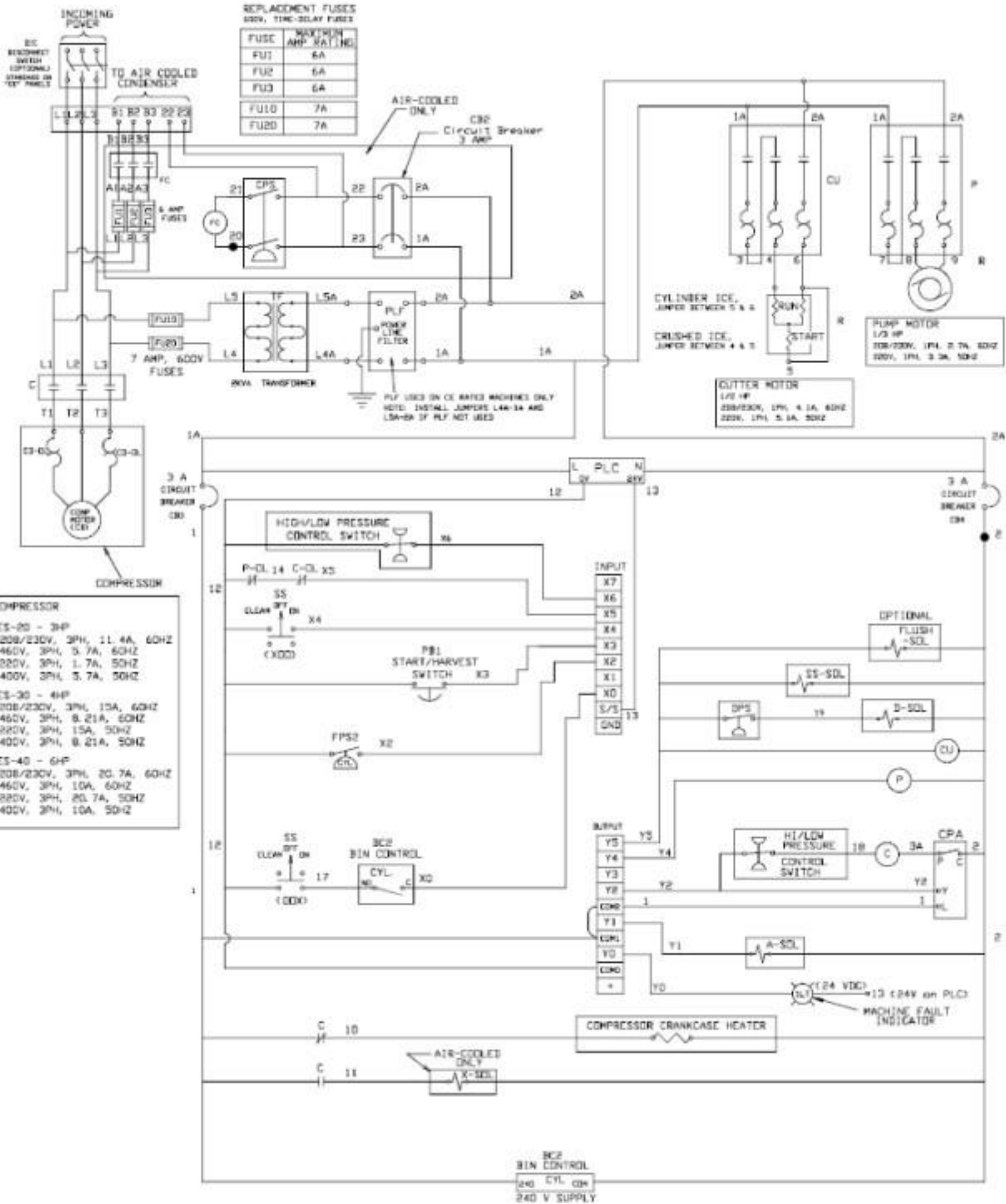

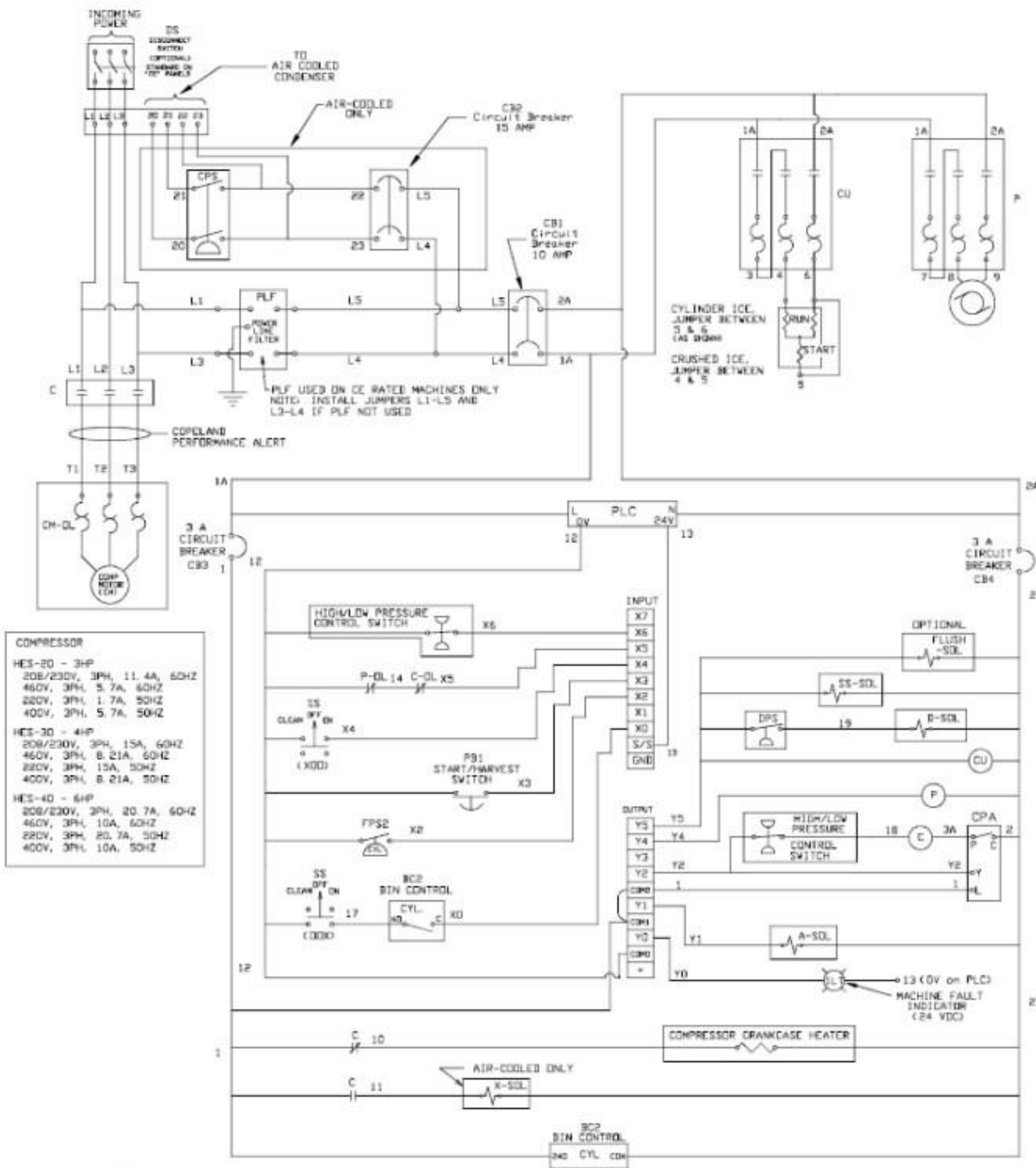

NOTE:

