

SERVICE CONNECTION
L2
L1

1FU = 2FU = 4A (SLOW BLOW)

MAIN TRANSFORMER CONNECTIONS

H1 COM
H2 208V
H3 240V
H4 480V

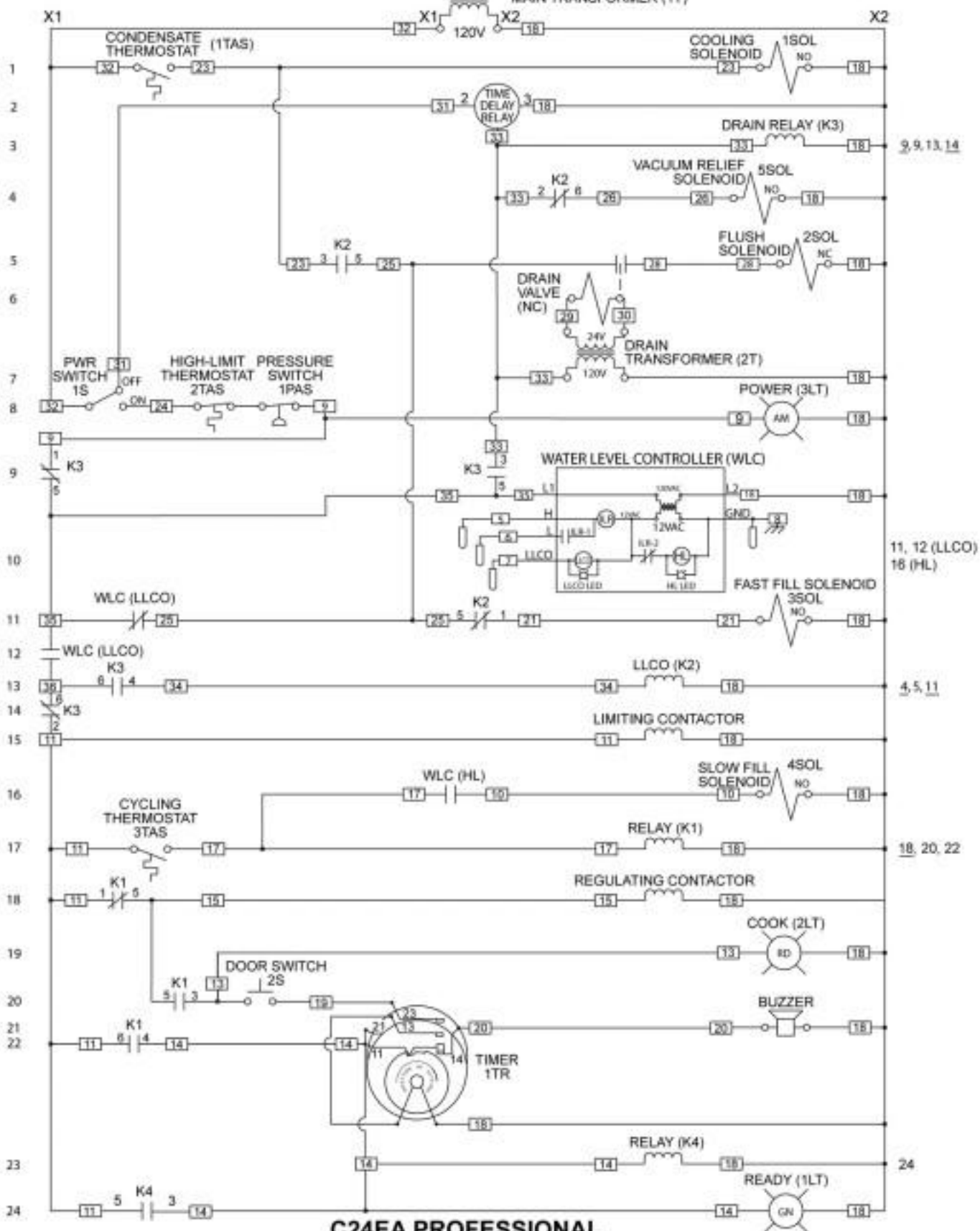

C24EA PROFESSIONAL

SERVICE CONNECTION
L1
L2

MAIN TRANSFORMER CONNECTIONS	
H1	COM
H2	208V
H3	240V
H4	480V

1FU = 2FU = 4A (SLOW BLOW)

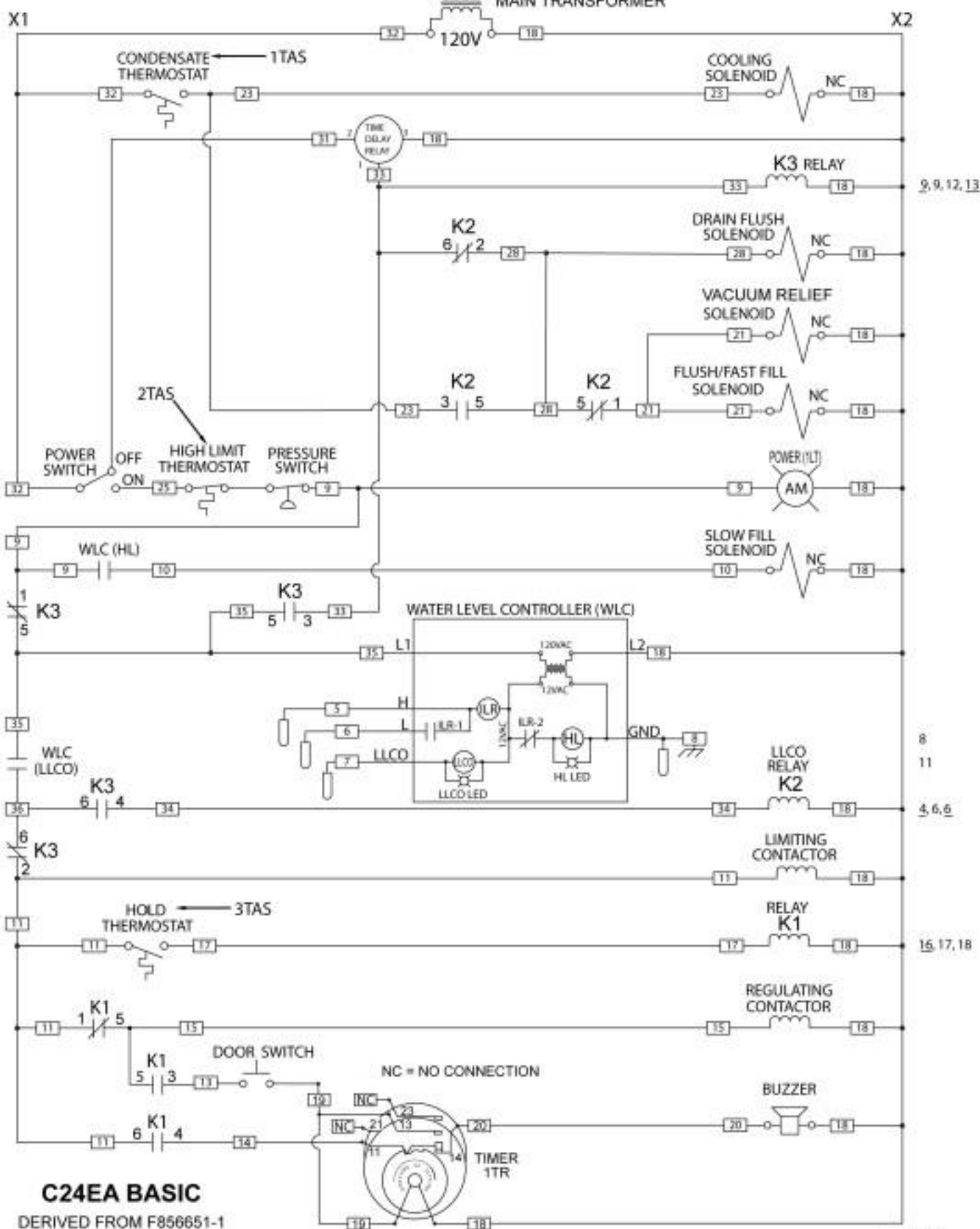

C24EA BASIC

DERIVED FROM F856851-1

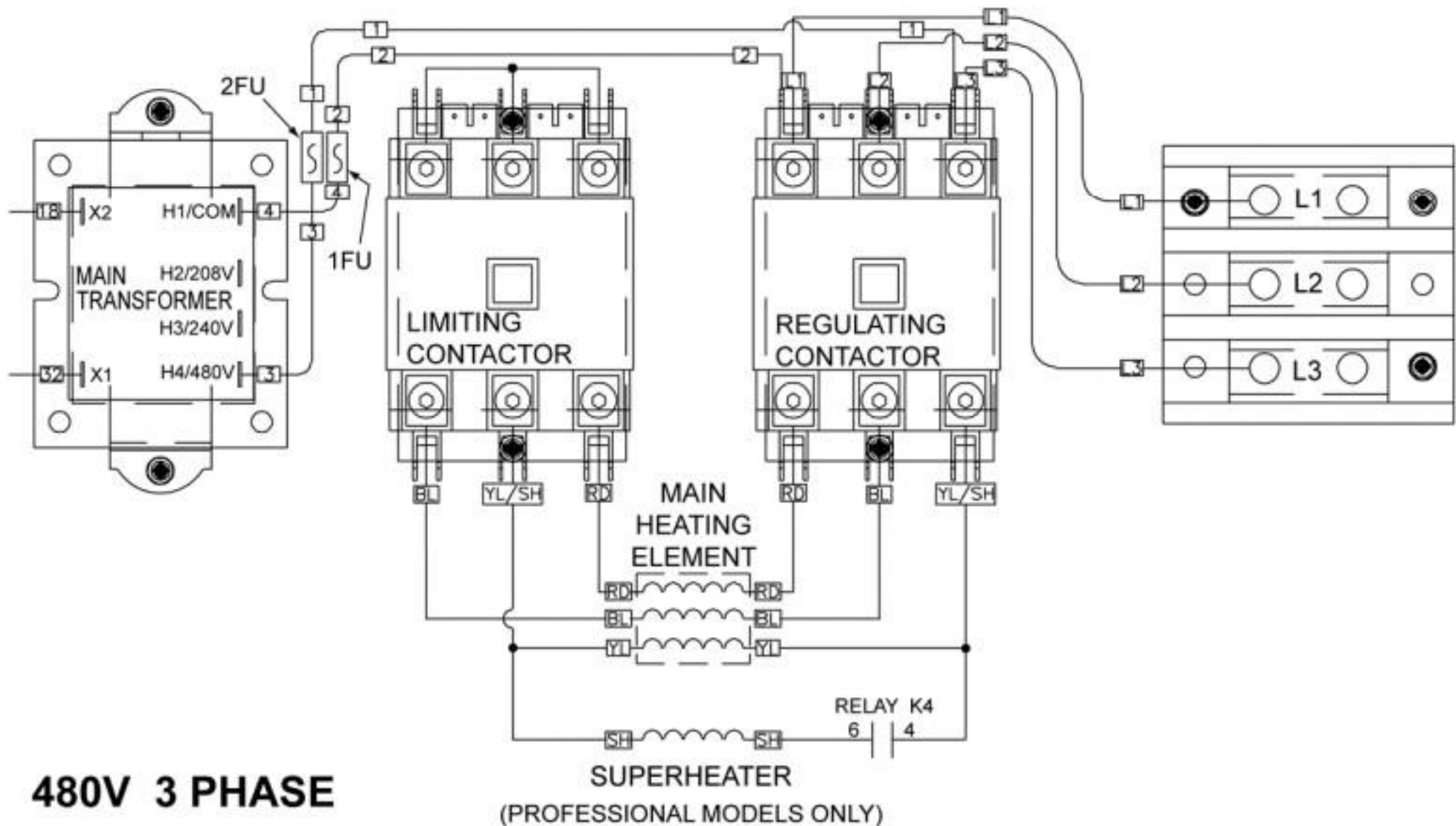

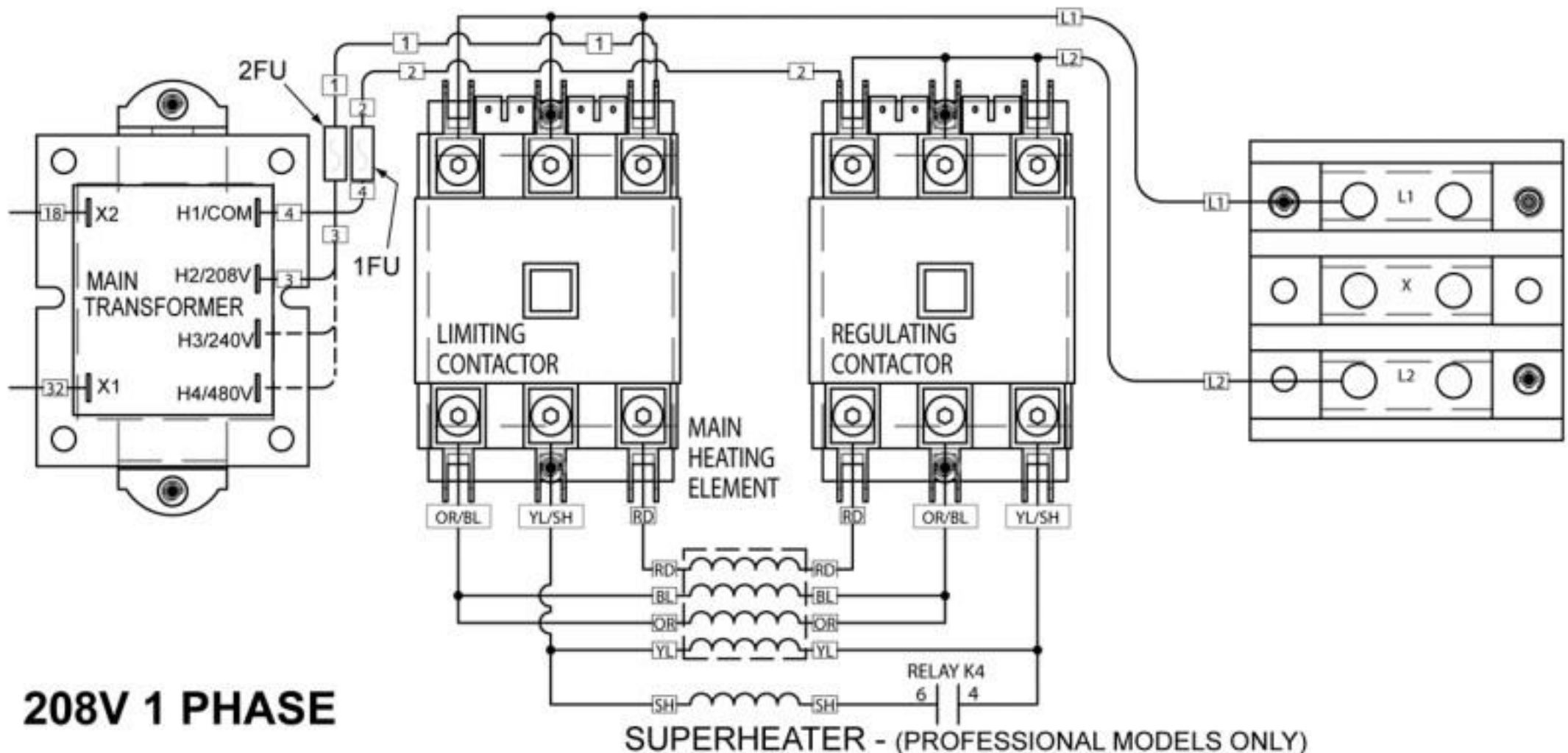

208V 1 PHASE

SUPERHEATER - (PROFESSIONAL MODELS ONLY)

