

GTS12 HEAVY DUTY ELECTRIC GRIDDLE TOP

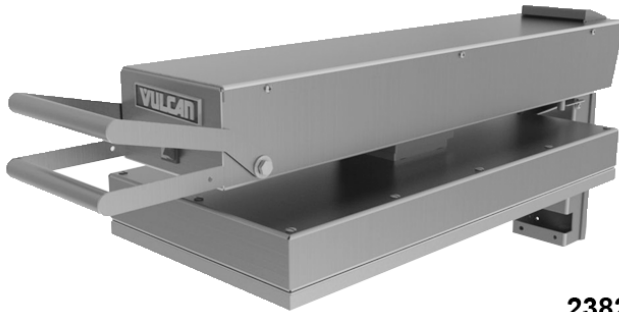

23823

GTS12

This Manual is prepared for the use of trained Vulcan Service Technicians and should not be used by those not properly qualified.

This manual is not intended to be all encompassing. If you have not attended a Vulcan Service School for this product, you should read, in its entirety, the repair procedure you wish to perform to determine if you have the necessary tools, instruments and skills required to perform the procedure. Procedures for which you do not have the necessary tools, instruments and skills should be performed by a trained Vulcan Service Technician.

The reproduction, transfer, sale or other use of this Manual, without the express written consent of Vulcan, is prohibited.

This manual has been provided to you by ITW Food Equipment Group LLC ("ITW FEG") without charge and remains the property of ITW FEG, and by accepting this manual you agree that you will return it to ITW FEG promptly upon its request for such return at any time in the future.

TABLE OF CONTENTS

GENERAL	3
Introduction	3
Installation, Operation & Cleaning	3
Tools	3
Specifications	3
REMOVAL AND REPLACEMENT OF PARTS	4
Removing Griddle Top from Frame	4
Covers and Panels	5
Lighted Switch Assembly	5
Power Cord	5
High Limit Cutoff Switch	6
Control Thermostat	7
Heating Element	9
Arm Mechanism	11
SERVICE PROCEDURES AND ADJUSTMENTS	13
Down Force Adjustment	13
Control Thermostat Test	13
Heating Element Test	14
ELECTRICAL OPERATION	15
Component Function	15
Wiring Diagram	15
TROUBLESHOOTING	16

© Vulcan 2012

GENERAL

INTRODUCTION

This manual is for the GTS12 Heavy Duty Electric Griddle Top. Procedures in this manual will apply to all models unless specified. Pictures and illustrations will be of model GTS12-1 unless otherwise noted.

All of the information, illustrations and specifications contained in this manual are based on the latest product information available at the time of printing.

MODELS	
GTS12-1	208V, Front Grease Trough
GTS12-2	240V, Front Grease Trough
GTS12-3R	208V, Rear Grease Trough
GTS12-4R	240V, Rear Grease Trough

INSTALLATION, OPERATION & CLEANING

Refer to the Operation and Field Installation Manual F38300 for specific installation, operation and cleaning instructions.

TOOLS

Standard

- Standard set of hand tools.
- Metric set of hand tools.
- VOM with A/C current tester (any quality VOM with a sensitivity of at least 20,000 ohms per volt can be used).

Special

- Temperature tester (thermocouple type).
- Torque wrench (in.-lb.).
- Clamp on type amp meter.

SPECIFICATIONS

ELECTRICAL SPECIFICATIONS			
Model No.	Voltage	Power	1 Phase Draw
GTS12-1	208 V	3.6 kW	17.3 A
GTS12-2	240 V	3.6 kW	15 A
GTS12-3R	208 V	3.6 kW	17.3 A
GTS12-4R	240 V	3.6 kW	15 A

REMOVAL AND REPLACEMENT OF PARTS

REMOVING GRIDDLE TOP FROM FRAME



WARNING Disconnect the electrical power to the machine and follow lockout / tagout procedures.

NOTE: Make sure that griddle top and griddle are cool before servicing.

1. Place cardboard or other protective covering on griddle surface to prevent scratching.

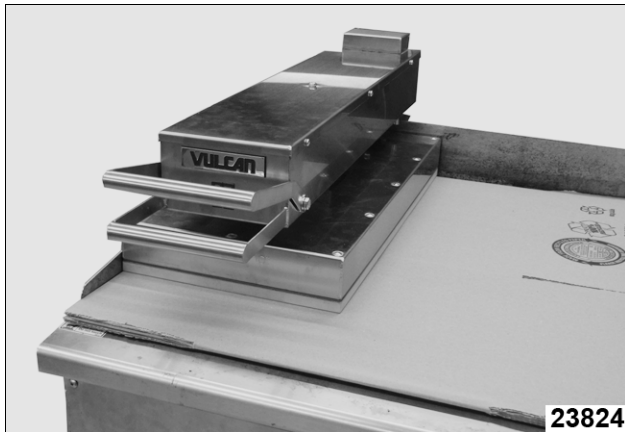

2. Remove 6 screws and move back cover out of the way.

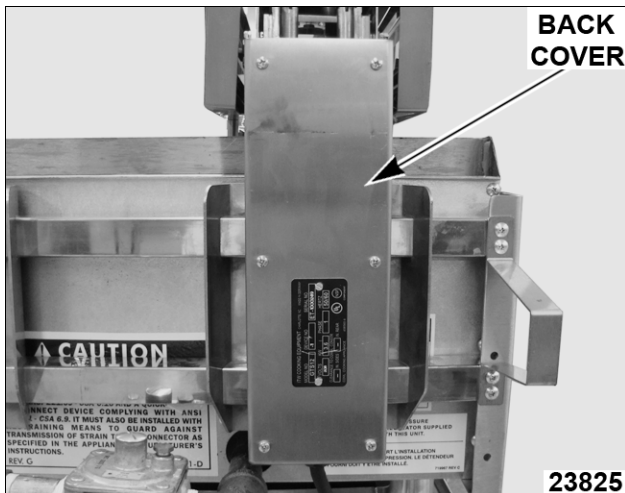

3. Put griddle top in complete vertical position.
4. Remove 2 nuts, spring guide bracket and 2 springs.

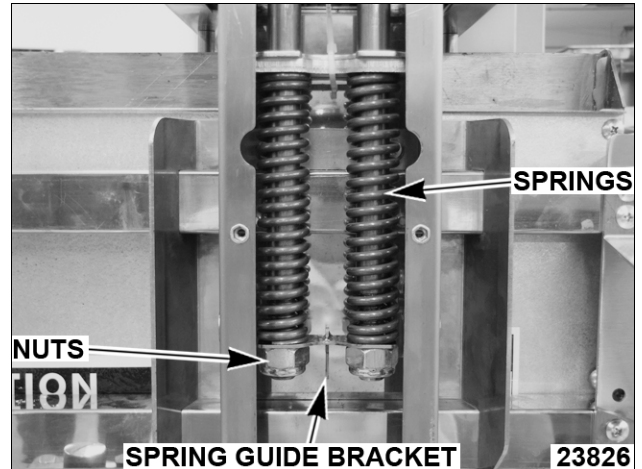

5. Remove 2 lower bolts.

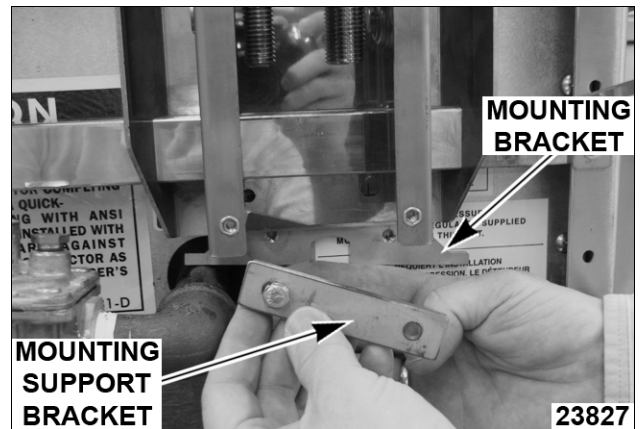

- A. Remove mounting support bracket and mounting bracket.
6. Remove 2 upper bolts.
 - A. Remove mounting support bracket and mounting bracket.
 7. Remove griddle top from frame.
 8. Reverse procedure to install.
 9. Check for proper operation.

COVERS AND PANELS



⚠ WARNING Disconnect the electrical power to the machine and follow lockout / tagout procedures.

Top Cover

1. Remove 7 screws and top cover.

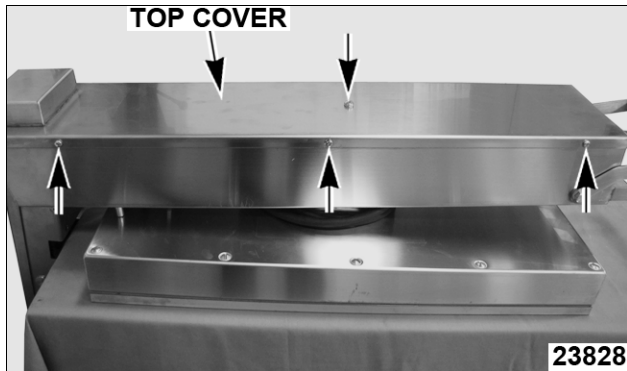

2. Reverse procedure to install.

Inner Liner

1. Remove TOP COVER.
2. Remove 4 screws securing inner liner.

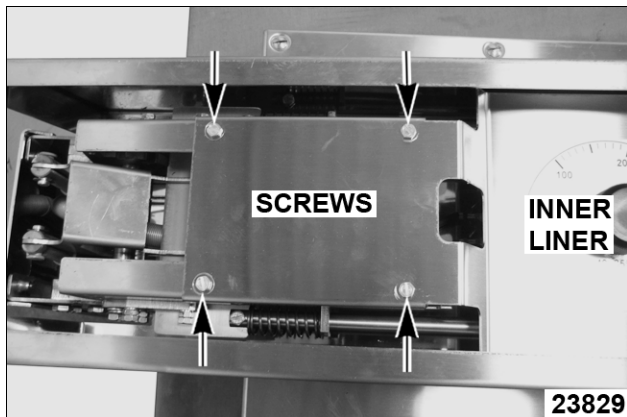

3. Reverse procedure to install.

LIGHTED SWITCH ASSEMBLY



⚠ WARNING Disconnect the electrical power to the machine and follow lockout / tagout procedures.

1. Remove TOP COVER.

2. Remove 4 screws and move INNER LINER out of the way.
3. Remove electrical connections, noting their locations.

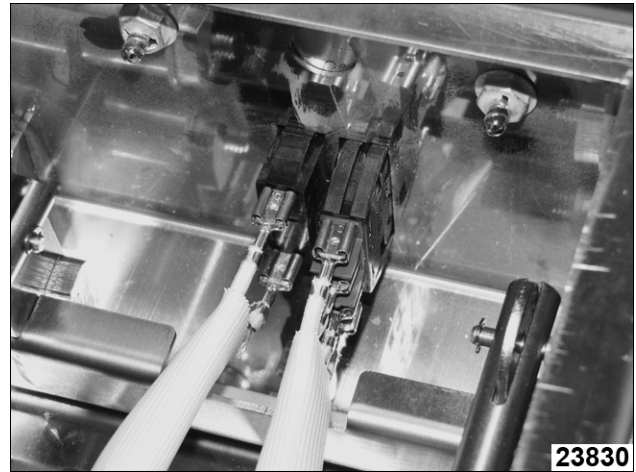

4. Pinch clips and push lighted switch assembly through.

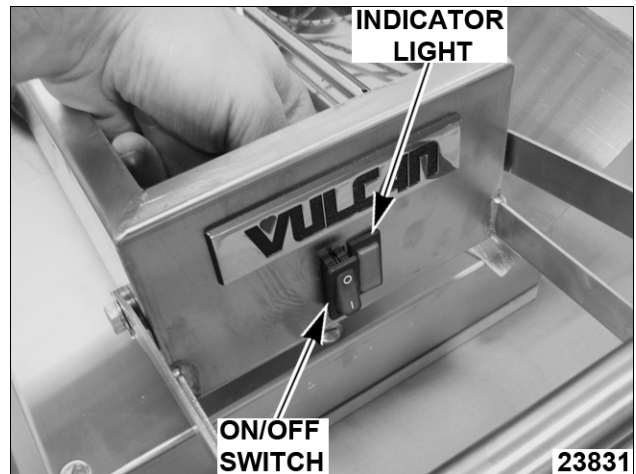

5. Reverse procedure to install.

NOTE: Ensure that terminal connections are completely seated and tight.

6. Check for proper operation.

POWER CORD



⚠ WARNING Disconnect the electrical power to the machine and follow lockout / tagout procedures.

1. Remove TOP COVER.
2. Remove 4 screws and move INNER LINER out of the way.

3. Disconnect power cord from terminal block.

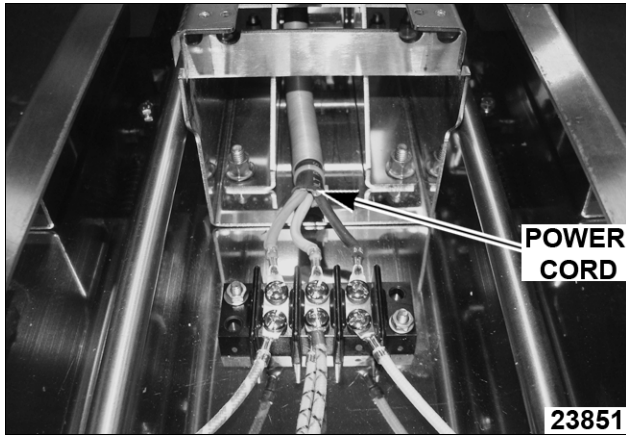

4. Remove back cover.
5. Transfer spring to replacement power cord.
6. Install retaining grommet onto new power cord 19" from tip of ring terminals.

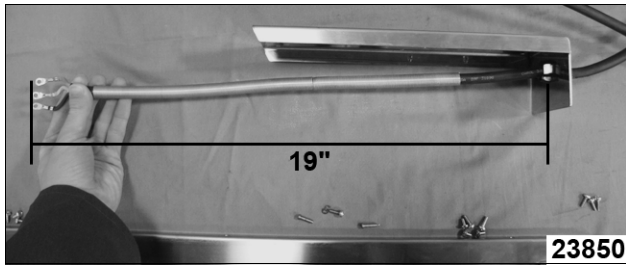

7. Install power cord.
8. Check for proper operation.

HIGH LIMIT CUTOFF SWITCH



WARNING Disconnect the electrical power to the machine and follow lockout / tagout procedures.

1. REMOVE GRIDDLE TOP FROM FRAME.
2. Remove TOP COVER.
3. Remove 4 screws and move INNER LINER out of the way.
4. Remove electrical connections from control thermostat and high limit, noting their location.
5. Disconnect heating element wires from terminal block.

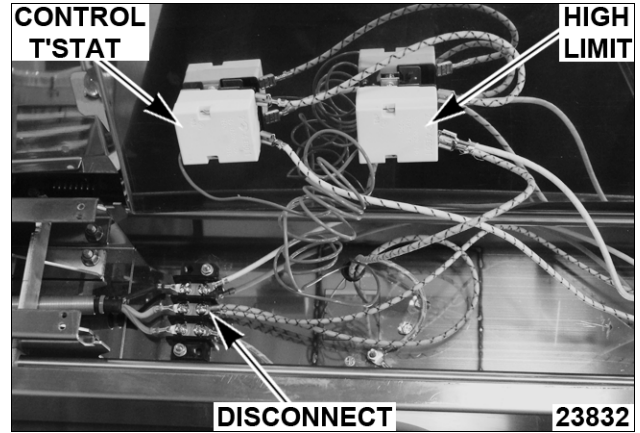

6. Pull off thermostat knob and remove 2 screws. Remove control thermostat body from inner liner.

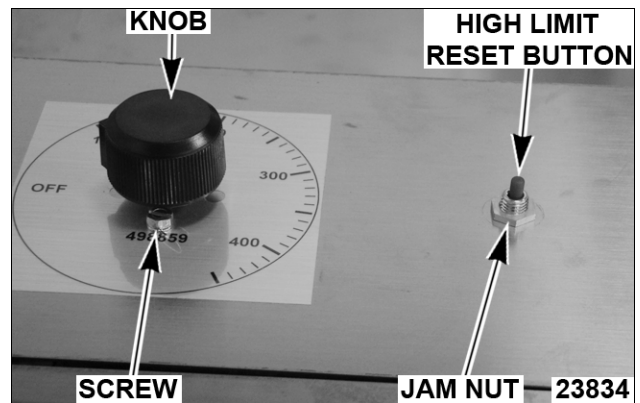

7. Remove jam nut from around high limit reset button. Remove high limit switch body from inner liner.
8. Disconnect cooking head assembly ground wires and remove 2 hex screws securing universal joint to upper arm body.

NOTE: Bend down edges of locking washer.

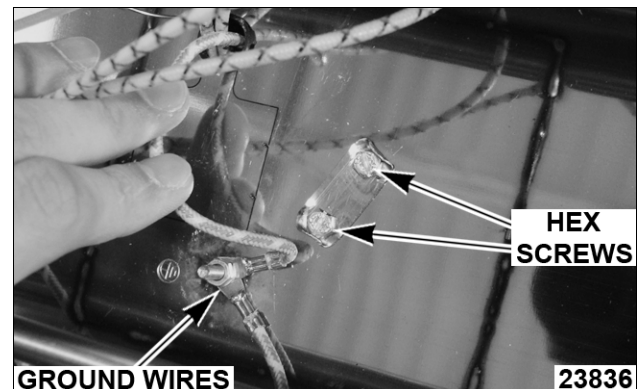

9. Carefully separate upper arm assembly from cooking head assembly.

NOTE: Be careful not to damage or pull the thermostat and high limit probes that are still attached in the cooking head.

10. For ease in servicing, remove knockout in upper arm assembly. Pass high limit and control thermostat through.

NOTE: Plastic ring must be used during reassembly.

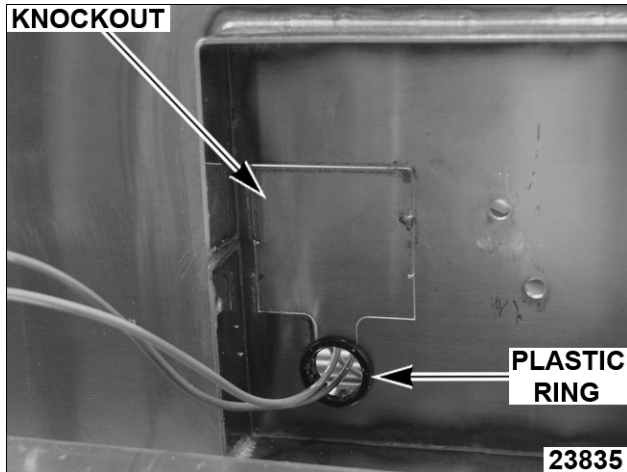

11. Remove all 12 screws around perimeter of cooking head assembly cover and 4 screws in the center around the universal joint. Separate cover from cooking head assembly.

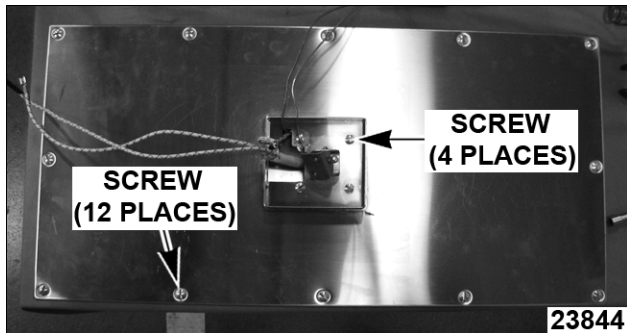

12. Remove nuts and washers holding high limit probe to insulation panel frame.

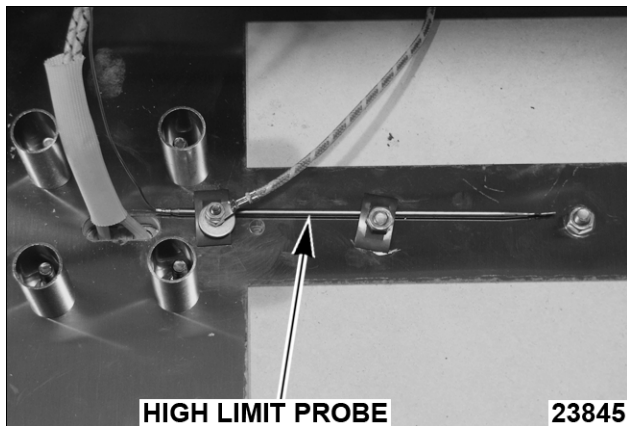

13. Remove high limit switch from griddle top.
14. Reverse procedure to install.
 - A. Bend up edges of locking washer to prevent universal joint hex screws from

backing out.

15. Check for proper operation.

CONTROL THERMOSTAT



WARNING Disconnect the electrical power to the machine and follow lockout / tagout procedures.

1. REMOVE GRIDDLE TOP FROM FRAME.
2. Remove TOP COVER.
3. Remove 4 screws and move INNER LINER out of the way.
4. Remove electrical connections from control thermostat and high limit, noting their location.
 - A. Disconnect heating element wires from terminal block.

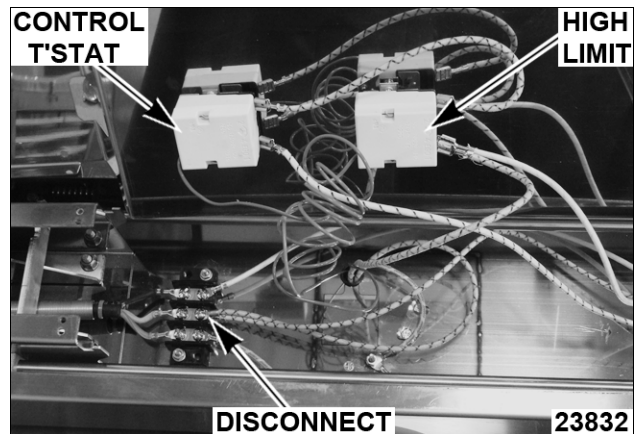

5. Pull off thermostat knob and remove 2 screws. Remove control thermostat body from inner liner.

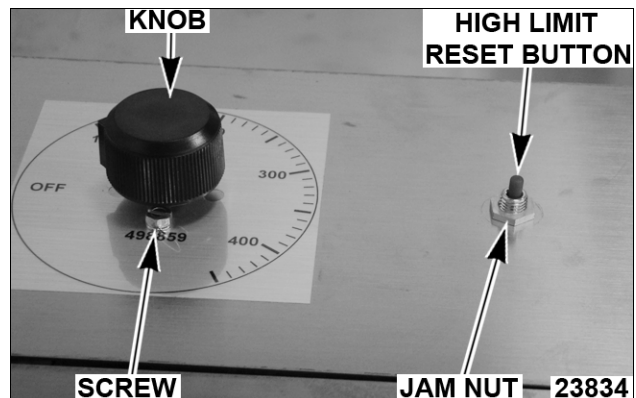

6. Remove jam nut from around high limit reset button. Remove high limit switch body from inner liner.

- Disconnect cooking head assembly ground wires and remove 2 hex screws securing universal joint to upper arm body.

NOTE: Bend down edges of locking washer.

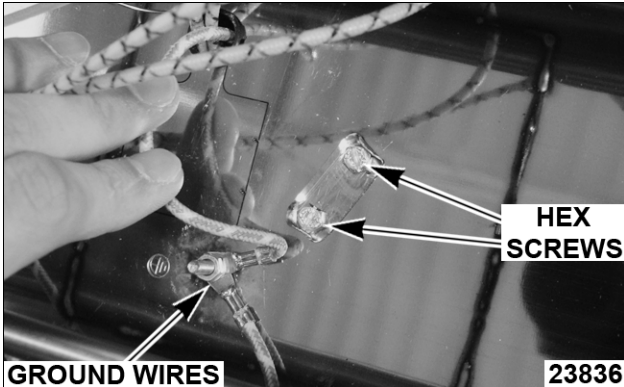

- Carefully separate upper arm assembly from cooking head assembly.

NOTE: Be careful not to damage or pull the thermostat and high limit probes that are still attached in the cooking head.

- For ease in servicing, remove knockout in upper arm assembly. Pass high limit and control thermostat through.

NOTE: Plastic ring must be used during reassembly.

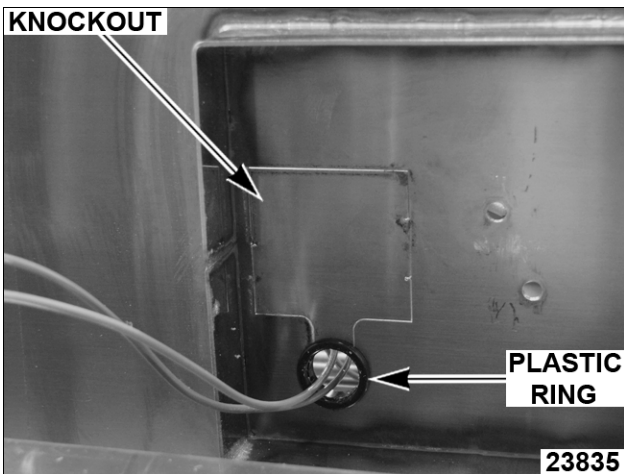

- Remove all 12 screws around perimeter of cooking head assembly cover and 4 screws in the center around the universal joint. Separate cover from cooking head assembly.

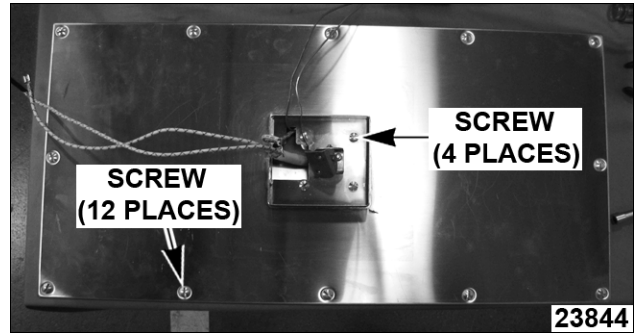

- Remove high limit probe and ground wire from insulation panel frame.

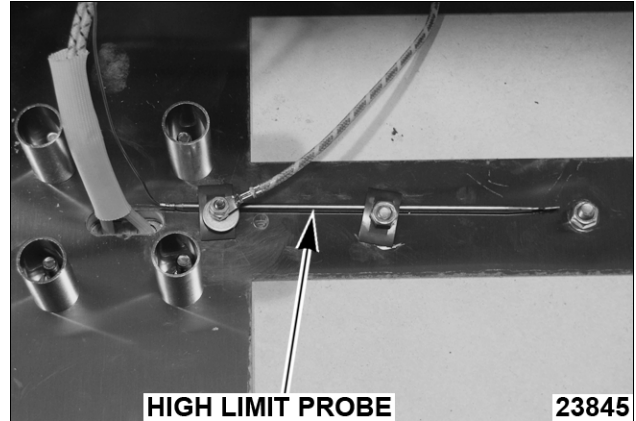

- Remove 4 center spacers and 12 nuts securing insulation panel frame to heating element.

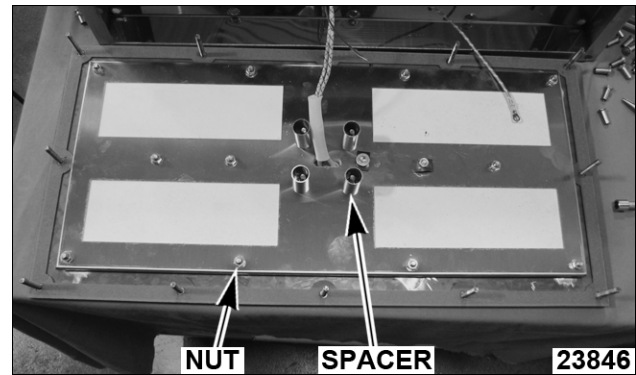

- Remove insulation panel frame and insulation panel.
- Remove 16 jam nut, flange nut, lock washer stacks securing pressure plate to heating element.

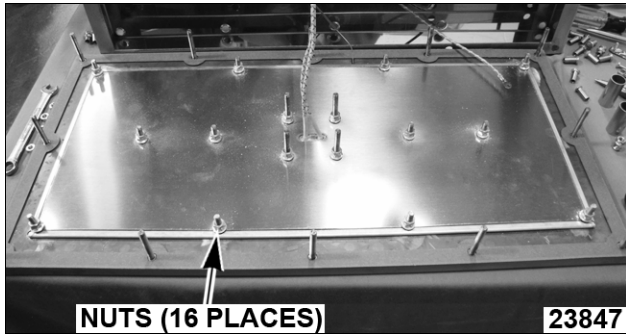

15. Remove pressure plate and heating element.
16. Remove thermostat probe from ceramic insulation strip in plate groove.

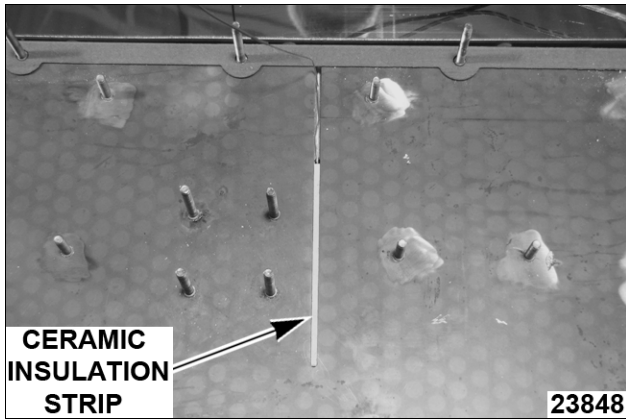

17. Remove control thermostat from griddle top.
18. Reverse procedure to install.
 - A. Bend up edges of locking washer to prevent universal joint hex screws from backing out.
19. Check for proper operation.

HEATING ELEMENT



WARNING Disconnect the electrical power to the machine and follow lockout / tagout procedures.

Removal

1. REMOVE GRIDDLE TOP FROM FRAME.
2. Remove TOP COVER.
3. Remove 4 screws and move INNER LINER out of the way.
4. Remove electrical connections from control thermostat and high limit, noting their location.
 - A. Disconnect heating element wires from terminal block.

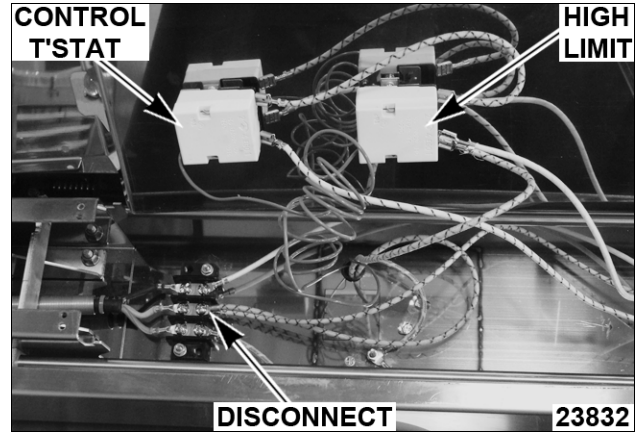

5. Pull off thermostat knob and remove 2 screws. Remove control thermostat body from inner liner.

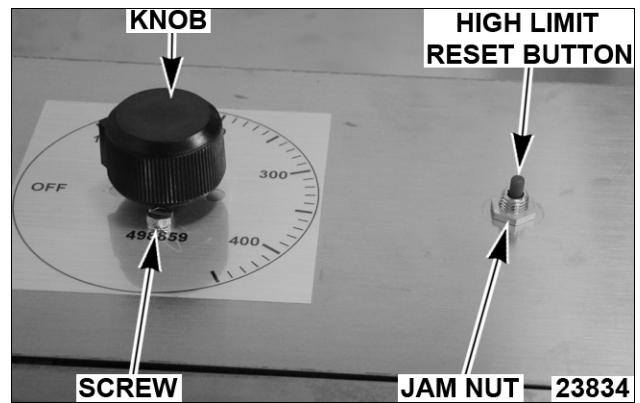

6. Remove jam nut from around high limit reset button. Remove high limit switch body from inner liner.
7. Disconnect cooking head assembly ground wires and remove 2 hex screws securing universal joint to upper arm body.

NOTE: Bend down edges of locking washer.

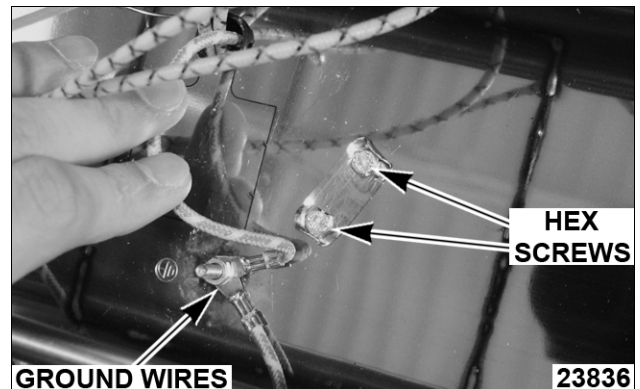

8. Carefully separate upper arm assembly from cooking head assembly.

NOTE: Be careful not to damage or pull the thermostat and high limit probes that are still attached in the cooking head.

- For ease in servicing, remove knockout in upper arm assembly. Pass high limit and control thermostat through.

NOTE: Plastic ring must be used during reassembly.

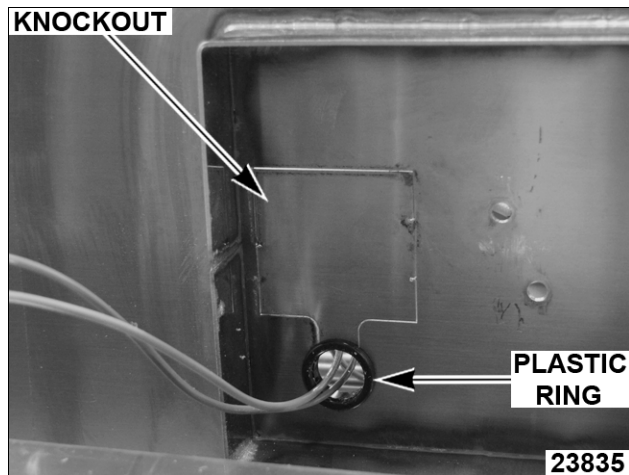

- Remove all 12 screws around perimeter of cooking head assembly cover and 4 screws in the center around the universal joint. Separate cover from cooking head assembly.

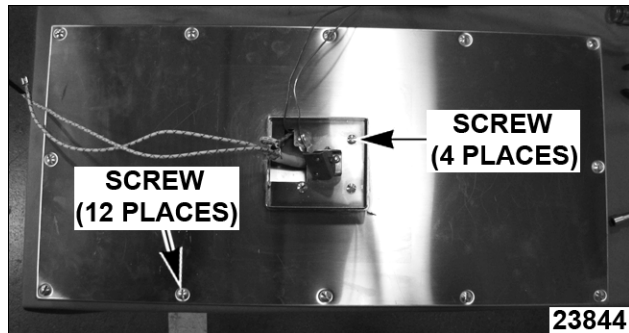

- Remove high limit probe and ground wire from insulation panel frame.

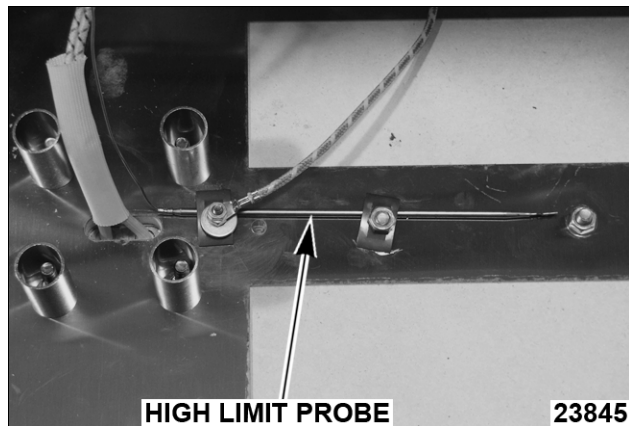

- Remove 4 center spacers and 12 nuts securing insulation panel frame to heating element.

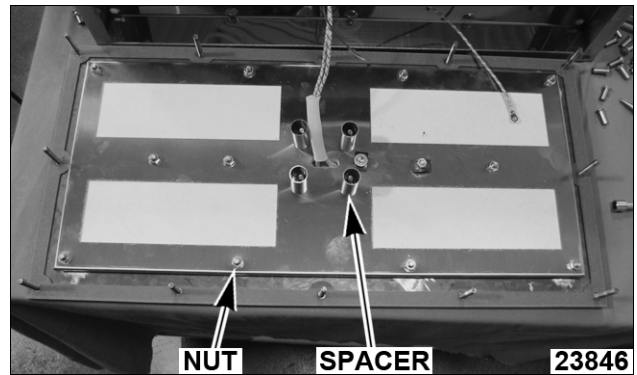

- Remove insulation panel frame and insulation panel.
- Remove 16 jam nut, flange nut, lock washer stacks securing pressure plate to heating element.

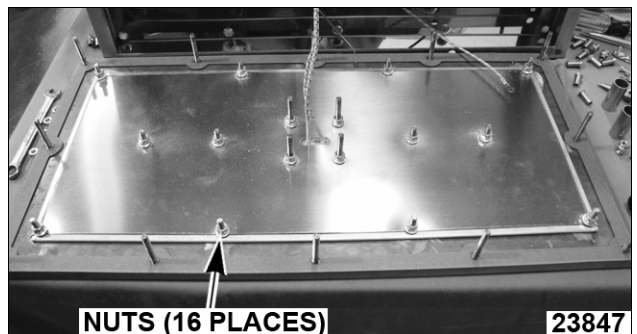

- Remove pressure plate and heating element.
- Remove the old cover gasket.
- Remove thermostat probe from ceramic insulation strip in plate groove.

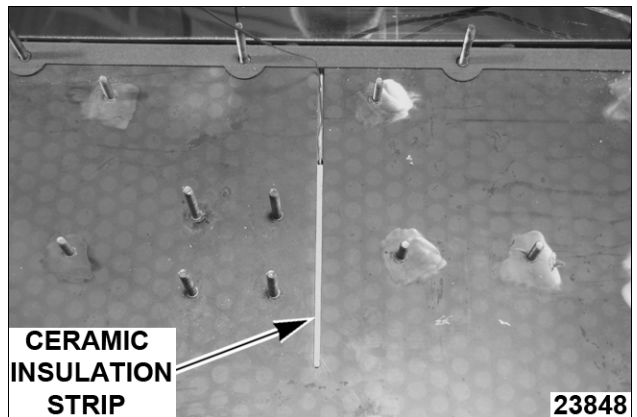

Replacement

- Ensure plate surface is clean and free of any particles or defects that may prevent contact between the heating element and plate.
- Install control thermostat probe into groove of plate with the ceramic insulation strip in place above it.

3. Install new cover gasket.
4. Seat new heating element in place.
 - A. Transfer protective sleeve to new element wires.

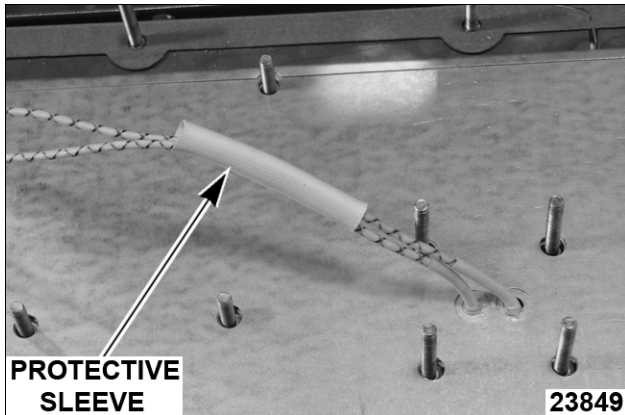

5. Install pressure plate and place a lock washer on each element stud, then finger tighten a flange nut on each lock washer.
6. Starting in the center of the element, tighten each row of flange nuts to 20 in.-lbs. in the following order.

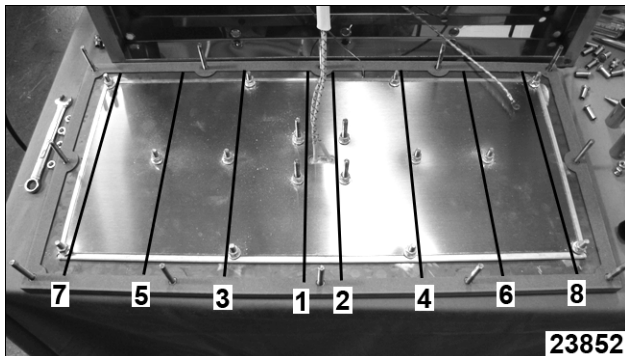

7. Install a top nut on each flange nut and torque to 20 in.-lbs.
8. Reinstall insulation panel, insulation frame and high limit probe.

NOTE: Only tighten nuts to 1/2 turn past finger tight. Over tightening can fracture the insulation panel.

9. Reverse removal procedure to install.
 - A. Bend up edges of locking washer to prevent universal joint hex screws from backing out.

10. Check for proper operation.

ARM MECHANISM



⚠ WARNING Disconnect the electrical power to the machine and follow lockout / tagout procedures.

Trigger Removal

1. Remove TOP COVER and move INNER LINER out of the way.
2. Remove bolts, washers and plate nuts.

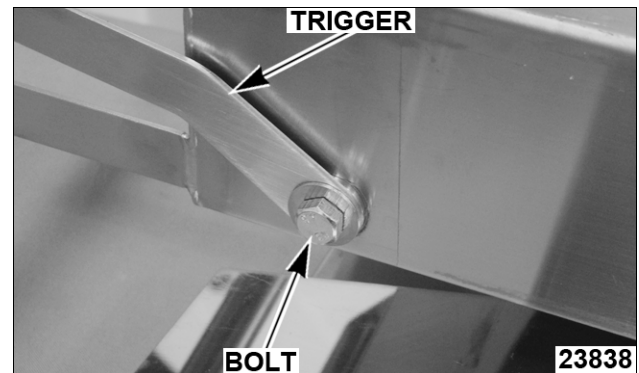

3. Remove trigger from pins.
4. Reverse procedure to install.
 - A. Orient plate nuts so that groove is on top, and rounded corner is towards handle.

Trigger Mechanism Removal

1. Remove trigger.
2. Remove e-clips and pins.

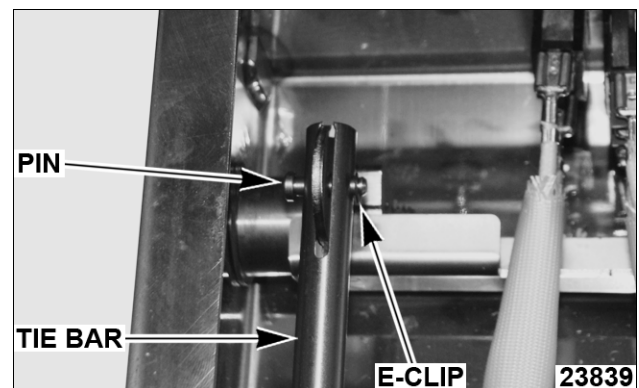

3. Disengage tie bars.
4. Unseat snap ring on one end, then push in other end of mechanism to remove.

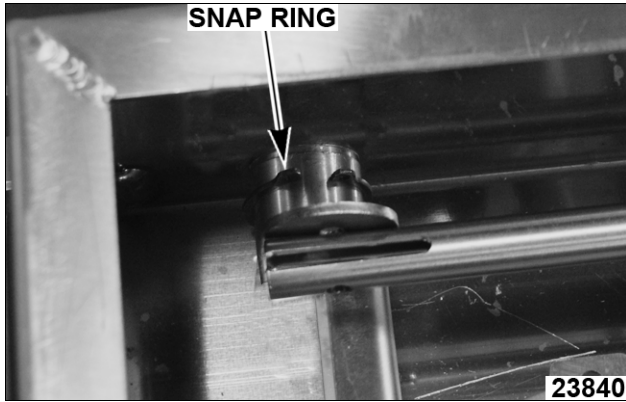

5. Reverse procedure to install.

Removing Mechanism From Arm Body

1. REMOVE GRIDDLE TOP FROM FRAME.
2. Remove TOP COVER and INNER LINER.
3. Remove e-clips and pins. Disengage tie bars.

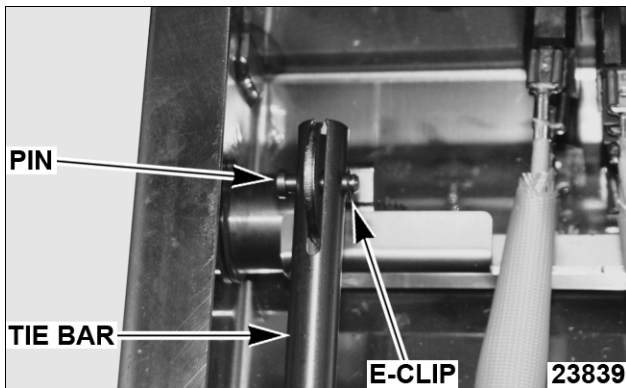

4. Remove power cord from terminal block and remove back cover.
 - A. Remove 4 bolts from weld nuts.

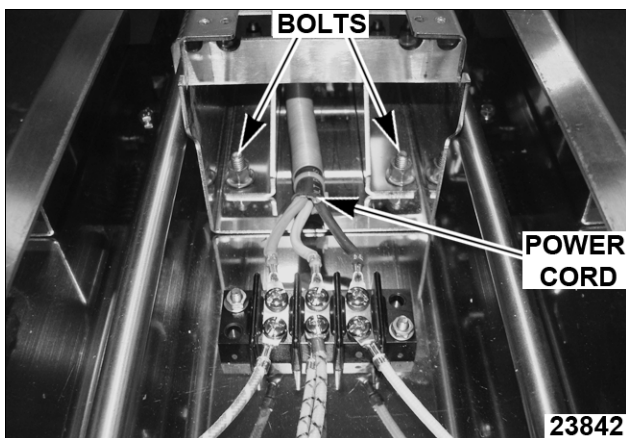

5. Remove mechanism from arm body.
6. Reverse procedure to install.

Locking Plate Replacement

1. REMOVE GRIDDLE TOP FROM FRAME.

2. Remove mechanism from arm body.
3. Remove slotted bolts from both sides.

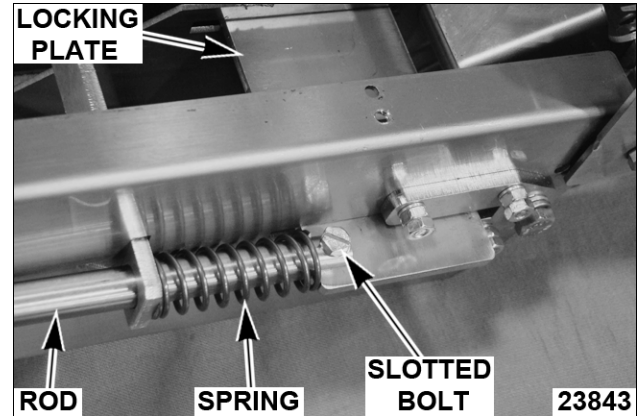

4. Pull rods and remove springs.
5. Slide out locking plate.
6. Reverse procedure to install.

SERVICE PROCEDURES AND ADJUSTMENTS



WARNING Certain procedures in this section require electrical test or measurements while power is applied to the machine. Exercise extreme caution at all times. If test points are not easily accessible, disconnect power and follow lockout / tagout procedures, attach test equipment and reapply power to test.

DOWN FORCE ADJUSTMENT

1. Remove 6 screws and back cover.

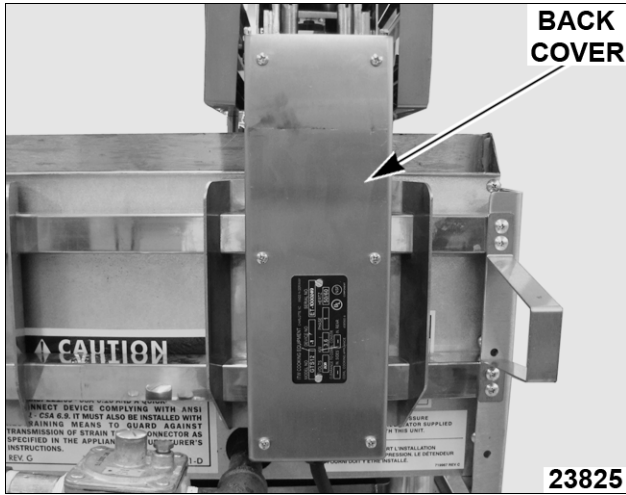

2. Tighten (decreases down force) or loosen (increases down force) both nuts evenly.

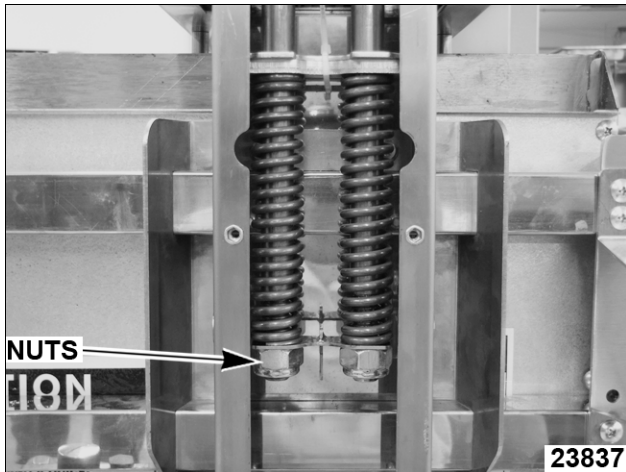

3. Reinstall back cover once desired down force is achieved.

CONTROL THERMOSTAT TEST

1. Mount temperature tester probe in center of griddle top plate, 8" down from the top edge.
2. Turn griddle top on and set to 350°F. Allow thermostat to cycle 3 times to preheat.
3. Record temperature when indicator light turns ON and OFF. Repeat for 3 cycles.
4. Calculate the temperature differential.

Differential = Indicator Light OFF - Indicator Light ON

Example: 365 - 340 = 25°F differential

- A. Differential should be less than 50°F.
- B. If differential is greater than 50°F, replace control thermostat.

5. Calculate the average temperature.

Average Temperature =

$$\frac{\text{Indicator Light OFF} + \text{Indicator Light ON}}{2}$$

2

Example: $365 + 345 = 710 \div 2 = 355^\circ\text{F}$

6. If average temperature differs more than 50°F from the dial setting, replace control thermostat.

HEATING ELEMENT TEST

1. Measure voltage at heating element leads and verify against data plate voltage.
 - A. If voltage is incorrect, find the source of the problem.
 - B. If voltage is correct, check current draw (amps) through the heating element lead wires.

NOTE: This method is preferred over a resistance check when a clamp on type amp meter is available.

2. If current draw is correct then heating element is functioning properly. **See table below for proper values.**
3. If current draw is not correct, turn griddle top OFF and disconnect the electrical supply.
 - A. Replace heating element then proceed to step 5.
4. If unable to check current draw, a resistance check may indicate a malfunctioning element.
 - A. Disconnect electrical supply and remove lead wires from heating element. Check resistance (ohms). **See table below for proper values.**
5. Check for proper operation.

VOLTS	POWER	AMPS	OHMS
208	3.6 kW	17.3	12
240	3.6 kW	15	16
NOTES:	1. Values in table are nominal. Tolerance is +5/-10%. 2. Resistance values (ohms) are @ 77°F room temperature.		

ELECTRICAL OPERATION

COMPONENT FUNCTION

- Lighted Switch Assembly** On/Off switch turns griddle top ON and OFF. Indicator light signals when power is being cycled to heating element.
- Control Thermostat** Monitors thermostat probe and cycles power to heating element.
- High Limit Thermostat** Protects griddle top by cutting power to heating element if temperature goes above 624°F.
- Heating Element** Heat source for griddle top.

WIRING DIAGRAM

208/240V SINGLE PHASE

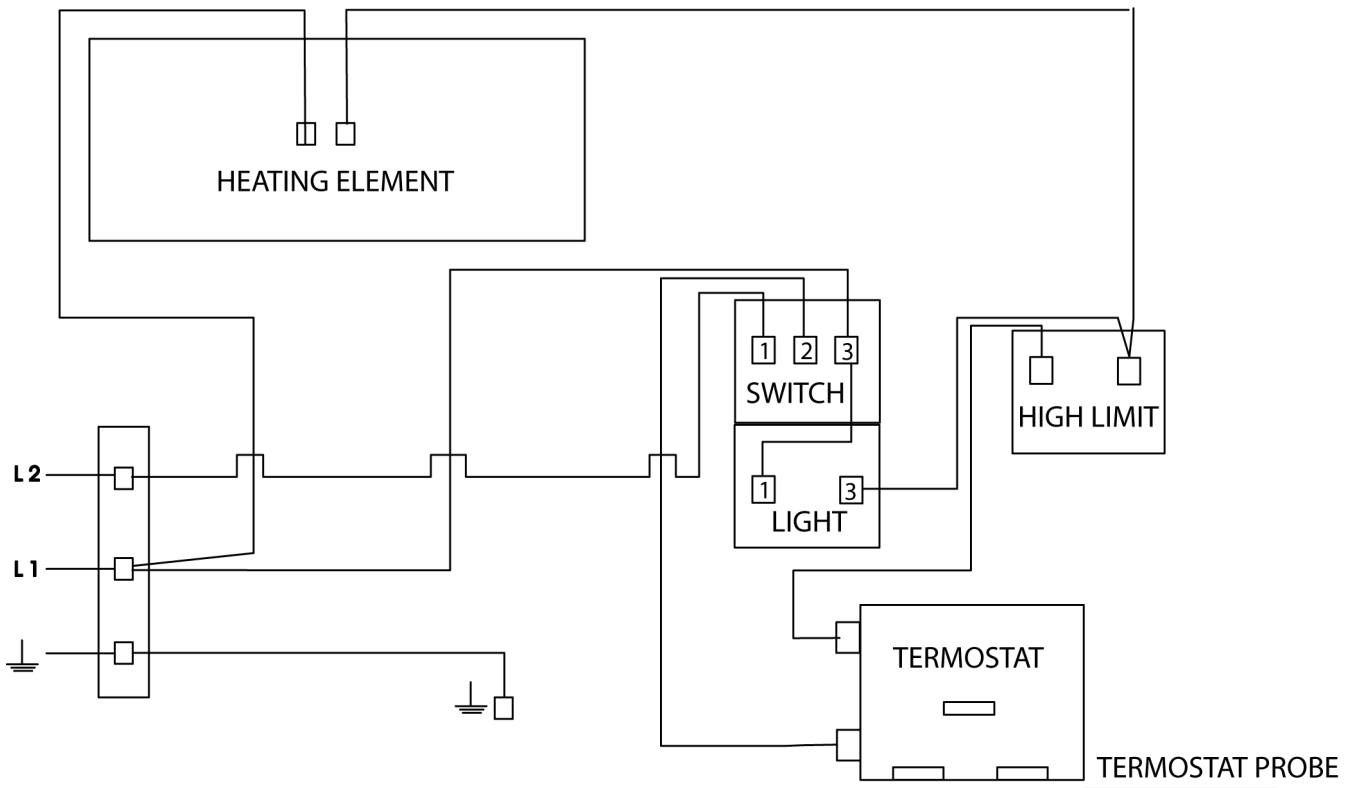

AI 3336

TROUBLESHOOTING

SYMPTOM	POSSIBLE CAUSE
Heat does not come on when power switch is turned ON.	<ol style="list-style-type: none"> 1. If power switch is not illuminated, check breaker panel and main power supply. 2. High limit cutoff switch is tripped - depress reset button. 3. Thermostat set too low. 4. High limit is opened. 5. Power switch malfunction. 6. Thermostat malfunction. 7. Heating element malfunction.
Heat does not come on when thermostat is turned ON.	<ol style="list-style-type: none"> 1. Power switch not in the ON position. 2. High limit cutoff switch is tripped - depress reset button. 3. Power not supplied to unit. 4. Power switch malfunction. 5. Thermostat malfunction. 6. Heating element malfunction.
Unit will not lock or remain in the raised position.	<ol style="list-style-type: none"> 1. Lift by lower handle only. Do not squeeze upper and lower handles together when raising. 2. Not raising high enough. Unit will only lock at the 47° and 90° position. 3. Problem with locking mechanism or handles.
Unit will not lower from the raised or locked position.	<ol style="list-style-type: none"> 1. Lift slightly (to take weight off) then squeeze the upper and lower handles together while lowering the unit. 2. Problem with locking mechanism.
Unit will not raise from the cooking or lowered position.	<ol style="list-style-type: none"> 1. Problem with locking mechanism. 2. Check that power cord is not binding.
Food under-cooked.	<ol style="list-style-type: none"> 1. Temperature set too low. 2. Food issue, see operator manual. 3. Cooking surface not touching or partially touching food when in the lowered position. Tension springs need to be adjusted.
Food over-cooked.	<ol style="list-style-type: none"> 1. Temperature set too high. 2. Food cooked for too long of a time. 3. Cooking surface pressing down too hard when in the lowered position. Tension springs need to be adjusted.
Food is being crushed.	<ol style="list-style-type: none"> 1. Cooking surface pressing down too hard when in the lowered position. Tension springs need to be adjusted.
Food sticks to cooking surface.	<ol style="list-style-type: none"> 1. Temperature set too high or too low. 2. Cooking surface needs to be cleaned. 3. Cooking surface not covered with enough cooking oil.