

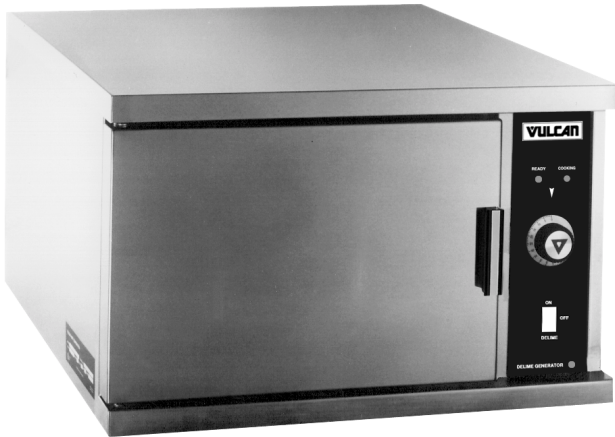

# SERVICE MANUAL



MODEL VSX3E SHOWN

## VSX SERIES CONVECTION STEAMERS (ELECTRIC AND GAS)

VSX3E	ML-52396	VSX10EC	ML-114824
VSX3E	ML-52397	VSX10EO	ML-114823
VSX4E	ML-52398	VSX5G	ML-114946
VSX5E	ML-52399	VSX5GC	ML-114947
VSX7EC	ML-114822	VSX7GC	ML-114949
VSX7EO	ML-114821	VSX10GC	ML-114949

### - NOTICE -

This Manual is prepared for the use of trained Vulcan Service Technicians and should not be used by those not properly qualified. If you have attended a Vulcan Service School for this product, you may be qualified to perform all the procedures described in this manual.

This manual is not intended to be all encompassing. If you have not attended a Vulcan Service School for this product, you should read, in its entirety, the repair procedure you wish to perform to determine if you have the necessary tools, instruments and skills required to perform the procedure. Procedures for which you do not have the necessary tools, instruments and skills should be performed by a trained Vulcan Service Technician.

Reproduction or other use of this Manual, without the express written consent of Vulcan, is prohibited.

# TABLE OF CONTENTS

GENERAL .....	3
Introduction .....	3
Specifications .....	4
Electric Steamers .....	4
Gas Steamers .....	4
Tools .....	5
Control Location .....	5
Water Conditioning .....	5
REMOVAL AND REPLACEMENT OF PARTS .....	6
Covers and Panels .....	6
Thermostats .....	7
Timer .....	9
Heating Elements (Electric) .....	9
Gas Solenoid Valve .....	9
Gas Pressure Regulator .....	11
Flame Sense Probe (Gas) .....	11
Water Level Control Board .....	11
Hot Surface Ignitor (Gas) .....	12
Gas Burner .....	12
Gas Ignition Module .....	13
Steam Generator Tank .....	13
Water Level Probes .....	14
Fill and Cold Water Solenoid Valves .....	15
Drain Valve .....	16
Door .....	18
SERVICE PROCEDURES AND ADJUSTMENTS .....	20
Steam Generator Cleaning .....	20
Delime Board Operation and Adjustment .....	20
Control Thermostat Adjustment .....	20
Drain Tank Manually .....	21
Door Sealing Adjustment .....	22
Door Latch Adjustment .....	22
Manifold Pressure Adjustment .....	23
Flame Sense Probe (Gas) .....	24
Hot Surface Ignitor (Gas) .....	25
Heating Element (Electric) .....	25
ELECTRICAL OPERATION .....	26
Component Function .....	26
Component Location .....	28
Electric Models .....	28
Gas Models .....	29
Water Level Control Operation .....	30
Sequence of Operation .....	30
Electric Models .....	30
Gas Models .....	32
Schematic Electric Steamers .....	34
Wiring Diagram Electric Steamers .....	35
Schematic Gas Steamers .....	36
Wiring Diagram Gas Steamers .....	37
TROUBLESHOOTING .....	38
All Models .....	38
Gas Models Only .....	40

# GENERAL

## INTRODUCTION

### General

This manual is applicable for all models listed on the cover page. Several models are pictured below for reference.

### Serial Number Break

Listed below, are the beginning serial numbers for each model when the solid state water level control (three probe design) was added.

MODEL	SERIAL
VSX-3	AP100704-9Q-4565
VSX-4	AP1007141-9Q-4615
VSX-5	AP1007555-11Q-5522

### Steam Cooking

Pressure-less steamers offer an efficient way to produce many foods in small portions or larger batches. Pressure-less, convection steam cooking will steam cook fresh foods or will steam defrost and cook frozen foods providing the maximum color, flavor and nutritional value with the least expenditure of energy and labor. The pressure-less steaming compartment allows the operator to open and close the door, anytime during a cooking cycle. The steam supply will shut off when the door is opened, then re-start when the door is closed.



**SPECIFICATIONS**

**Model Designations** (based on 2.5 inch pan depth)

- VSX3 - 3 pan unit.
- VSX4 - 4 pan unit.
- VSX5 - 5 pan unit.
- VSX7 - Combination VSX3 and VSX4 unit.
- VSX10 - Combination of two VSX5 units.

**Electric Steamers**

		AMPERAGE				
		3 PHASE			1 PHASE	
MODEL	TOTAL KW	208V	240V	480V	208V	240V
VSX3E	7.5 std.	20.9	18.1	9.0	36.1	31.3
	10.0 opt.	27.8	24.1	12.1	48.1	41.7
VSX4E	10.0	27.8	24.1	12.1	48.1	41.7
VSX5E	15.0	41.6	36.2	18.1	72.2	62.5
VSX7E	17.5	48.7	42.2	21.1		
VSX10E	30	83.2	72.4	36.2		

**Gas Steamers**

MODEL	INPUT BTU/HR		MANIFOLD PRESSURE (INCHES W.C.)		LINE PRESSURE (INCHES W.C.)					LOAD (WATTS)	AMPS (MAX)
	NAT.	PROP.	NAT.	PROP.	NATURAL		PROPANE		MAX		120V 60HZ
					RECOMMEND	MIN	RECOMMEND	MIN			
VSX5G	45,000	45,000	3.5	5.0	7.0	5.0	11.0	7.0	14.0	180	1.5
VSX5GC	45,000	45,000	3.5	5.0	7.0	5.0	11.0	7.0		180	1.5
VSX7GC	90,000	90,000	3.5	5.0	7.0	5.0	11.0	7.0		360	3.0
VSX10GC	90,000	90,000	3.5	5.0	7.0	5.0	11.0	7.0		360	3.0

**Water Supply**

- Supply pressure should be ..... 20-80 psig
  - In line strainer for supply line (Supplied)
  - Total dissolved solids (TDS)\* ..... less than 60 ppm
  - Total alkalinity ..... less than 20 ppm
  - Silica ..... less than 13 ppm
  - Chloride ..... less than 30 ppm
  - PH factor ..... 7 to 8
- (\*17.1 ppm = 1 grain of hardness)

## TOOLS

### Standard

- Standard set of hand tools.
- VOM with an AC current tester (any quality VOM with a sensitivity of at least 20,000 ohms per volt can be used).
- Gas leak checking equipment.

### Special

- CLR Treatment Kit (p/n 817634) - Used to remove Calcium/Lime/Rust from a steam generator tank.

## CONTROL LOCATION



(Gas Model Shown)

## WATER CONDITIONING

Furnishing the steam generator with soft water to reduce scale formation is important. Scale formation will reduce steam output, cause premature component failure, and shorten equipment life. Most water supplies contain scale producing minerals such as Calcium and Magnesium. As steam is generated, the minerals remain and dissolve into the water. As the concentration of these minerals increases past a certain point, they precipitate from the water and coat the inside of the tank, heating elements, thermostat bulbs and water level probes. Because of the high temperature of these surfaces, the precipitated minerals bake onto them and become very difficult to remove.

This phenomenon causes several problems:

1. Reduce the heat transfer efficiency of the heaters.
2. Cause premature failure of the heaters.
3. Water level probes will give false readings.
4. Thermostat bulbs will sense temperature incorrectly.

These problems are common to any manufacturer's steamer regardless of design, but they can all be prevented by furnishing the steam generator tank with soft water. Vulcan recommends the water contain less than 60ppm of "total dissolved solids" (TDS) and have a PH factor between 7 to 8. These water properties can be achieved by using a properly maintained water softener.

Other chemical properties in water supplies can also affect good steam generation and vary from within each state and locality.

The water level probes in the steam generator tank use ions in the water to detect the water level. **Do not use** fully demineralized or de-ionized water since it is "non conductive" and the water level can not be detected.

**NOTE:** The use of strainers, or fibers will not remove minerals from the water.

Therefore, it is recommended that a local water treatment specialist be consulted before the installation of any steam generating equipment.

Steamers that operate over a long period of time without the benefit of a water softener, which have developed a heavy scale build up, should be cleaned before using a water softener.

# REMOVAL AND REPLACEMENT OF PARTS

## COVERS AND PANELS

**WARNING:** DISCONNECT THE ELECTRICAL POWER TO THE MACHINE AT THE MAIN CIRCUIT BOX. PLACE A TAG ON THE CIRCUIT BOX INDICATING THE CIRCUIT IS BEING SERVICED.

### Right Side Panel

1. Remove screws from the bottom of the panel.
2. Slide panel down to clear the top cover.
3. Reverse procedure to install.

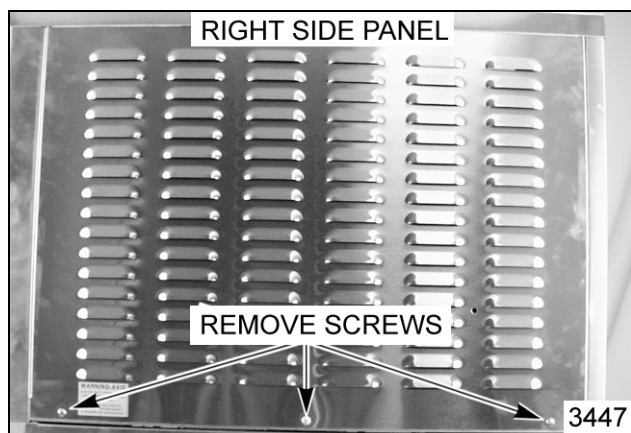

(Gas Model Shown)

### Top Cover

1. Remove screws from the top rear of cover. If steamer is a gas model, follow steps 1A and 1B.
  - A. Remove the screws at the base of the exterior flue housing and lift off.

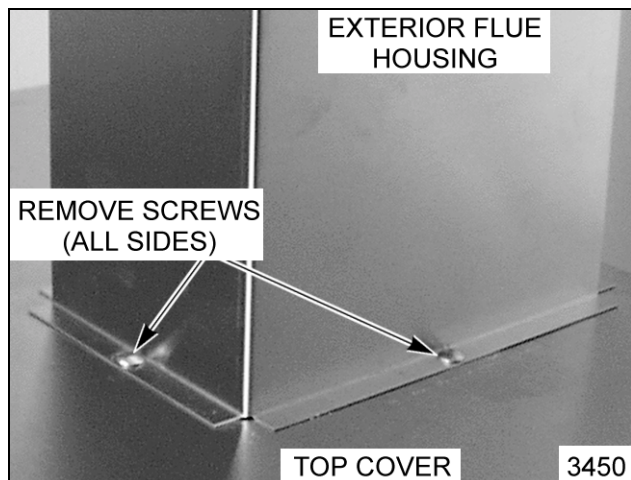

- B. Remove the screws that secure the flue to the tank and lift it off.

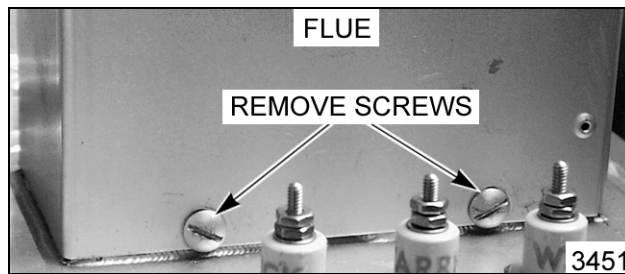

2. Push up on the rear of the cover and slide the top cover forward to clear the front edge.
3. Lift the cover off the cabinet.
4. Reverse procedure to install.

### Left Side and Rear Panel

1. Remove the top cover screws and disconnect the utilities.

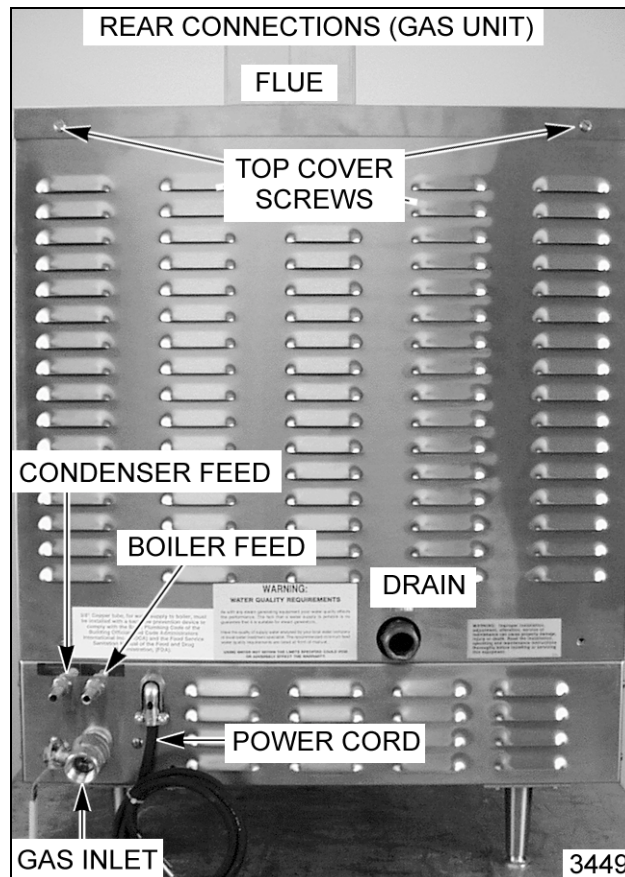

- Remove the screws at the bottom of panel.



- Remove the lower access panels on the right and left side of the unit to gain access to the lower compartment.

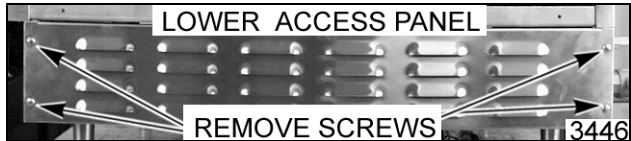

- Remove the screws inside the lower compartment that run along the top rear of the base frame that secure the lip of the rear panel.

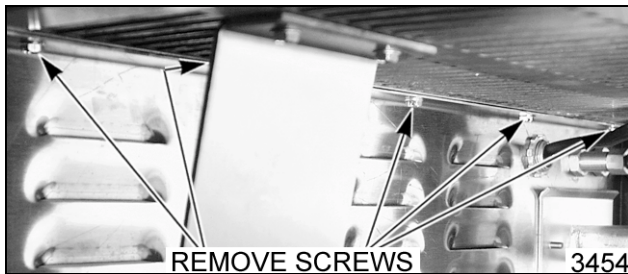

**NOTE:** Rear panel lip is “sandwiched” between the base frame and the top lip of the small rear access panel.

- Pull the combination left side and rear panel off.
- Reverse procedure to install.

## THERMOSTATS

**WARNING:** DISCONNECT THE ELECTRICAL POWER TO THE MACHINE AT THE MAIN CIRCUIT BOX. PLACE A TAG ON THE CIRCUIT BOX INDICATING THE CIRCUIT IS BEING SERVICED.

- Turn “off” the water supply and allow hot parts to cool down if necessary.
- Remove the right side panel as outlined under “COVERS AND PANELS”.
- Manually drain the steam generator tank if necessary, as outlined in “DRAIN TANK MANUALLY”.
- Disconnect the lead wires from thermostat being

replaced.

- Remove screws that secure the thermostat.

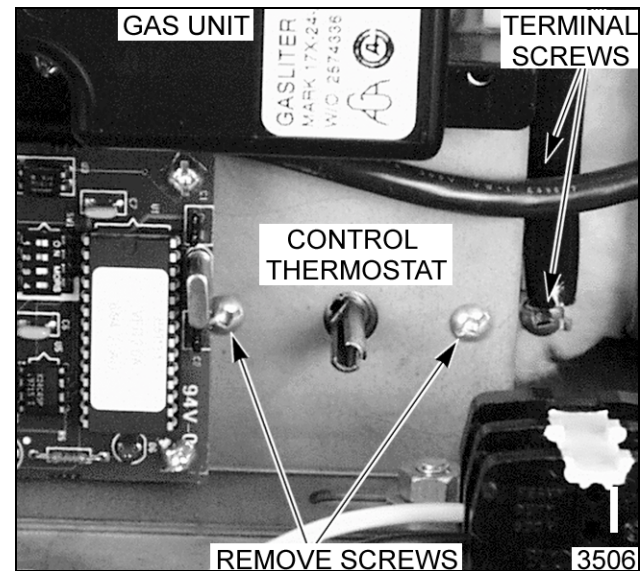
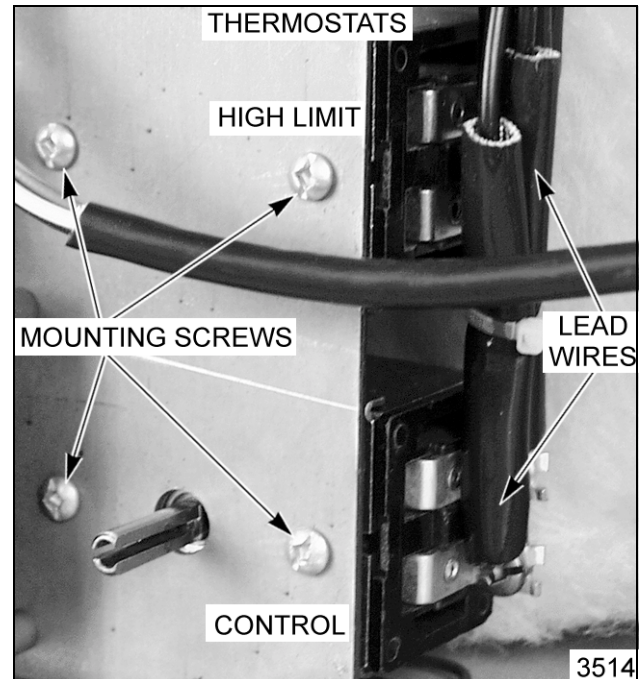

- If replacing the control thermostat, fully loosen the compression nut, sliding it away from tank, then remove the bulb.

**NOTE:** When installing, do not over tighten as thermostat calibration and/or damage to thermostat may occur.

7. If replacing the high limit thermostat:

**A. Electric Models**

- 1) Remove nut on capillary tube hold down clamp.
- 2) Fully loosen the small capillary tube compression nut and slide it away from heater.
- 3) Remove large capillary nut from heater base plate and slide it away from heater.

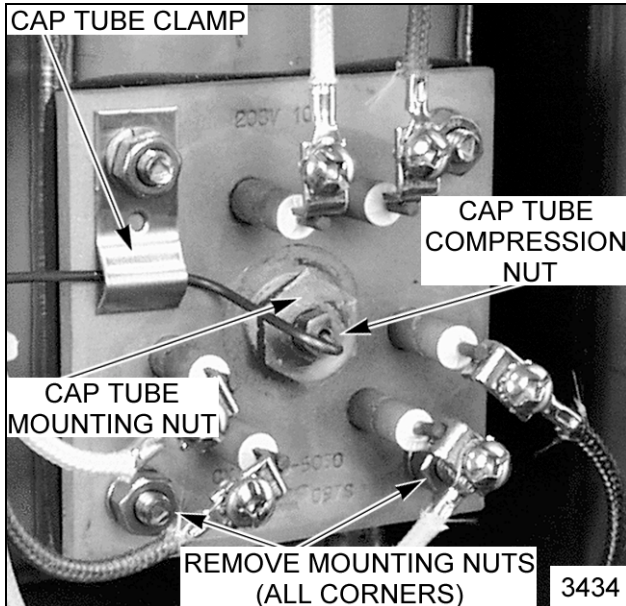

- 4) Remove the remaining nuts that secure heater to the tank and pull heater out just enough to expose the holding sleeve on the element and the bulb.

**NOTE:** Cut the wire ties holding the heater lead wires together so the heating element can be pulled out without disconnecting the lead wires.

- 5) Pull the bulb from its holding sleeve and remove from the heater.

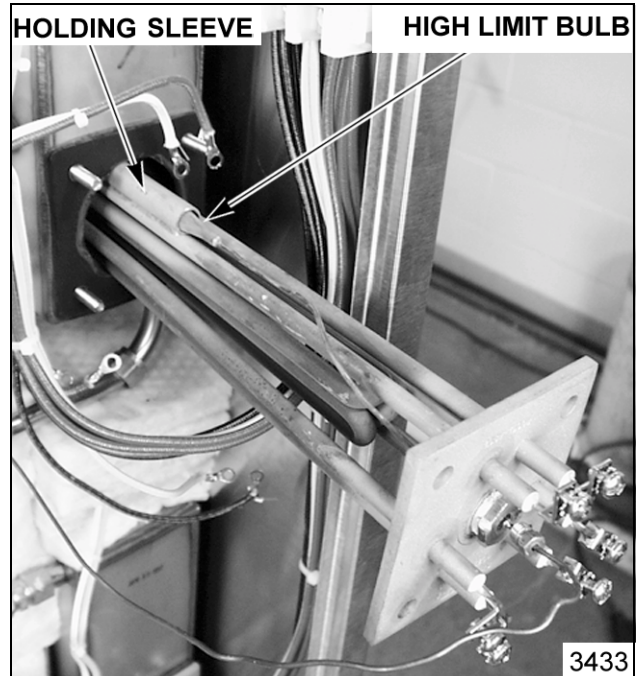

**B. Gas Models**

- 1) Remove the nuts securing the thermostat to the tank surface plate and lift it off.

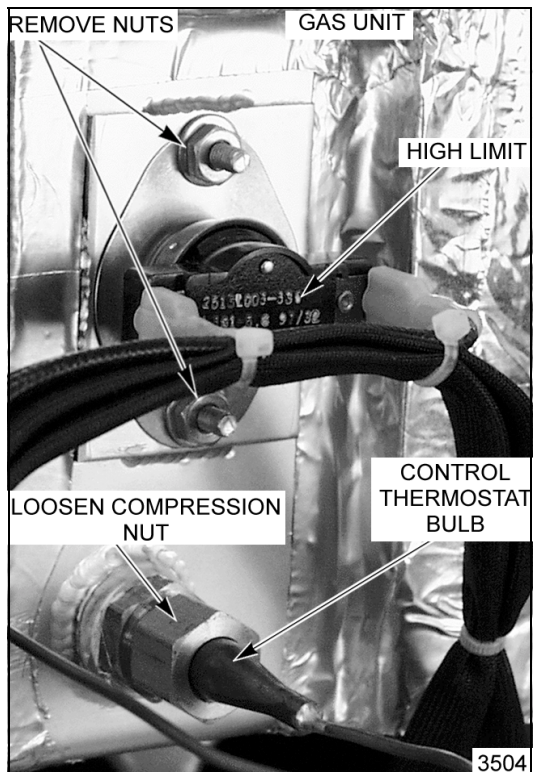

8. Reverse the procedure to install the new thermostat and check for proper operation as outlined under "CONTROL THERMOSTAT ADJUSTMENT".

## TIMER

**WARNING:** DISCONNECT THE ELECTRICAL POWER TO THE MACHINE AT THE MAIN CIRCUIT BOX. PLACE A TAG ON THE CIRCUIT BOX INDICATING THE CIRCUIT IS BEING SERVICED.

1. Remove the right side panel as outlined under "COVERS AND PANELS".
2. Pull timer knob from shaft.
3. Disconnect lead wires to timer.
4. Remove nut from timer shaft and remove timer from the unit.

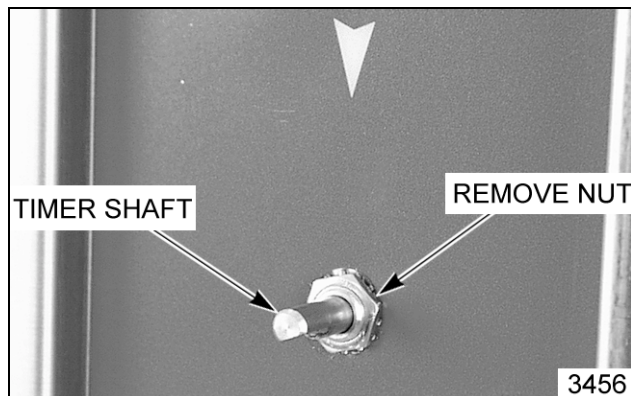

5. Reverse the procedure to install.

## HEATING ELEMENTS (ELECTRIC)

**WARNING:** DISCONNECT THE ELECTRICAL POWER TO THE MACHINE AT THE MAIN CIRCUIT BOX. PLACE A TAG ON THE CIRCUIT BOX INDICATING THE CIRCUIT IS BEING SERVICED.

1. Turn "off" the water supply and allow hot parts to cool down if necessary.
2. Remove the right side panel as outlined under "COVERS AND PANELS".
3. Manually drain steam generator tank if necessary, as outlined under "DRAIN TANK MANUALLY".
4. Disconnect the heater lead wires and remove the high limit thermostat bulb from heater as outlined under "THERMOSTATS".

5. Remove the nuts that secure the heater to the tank and remove the heater from the unit.

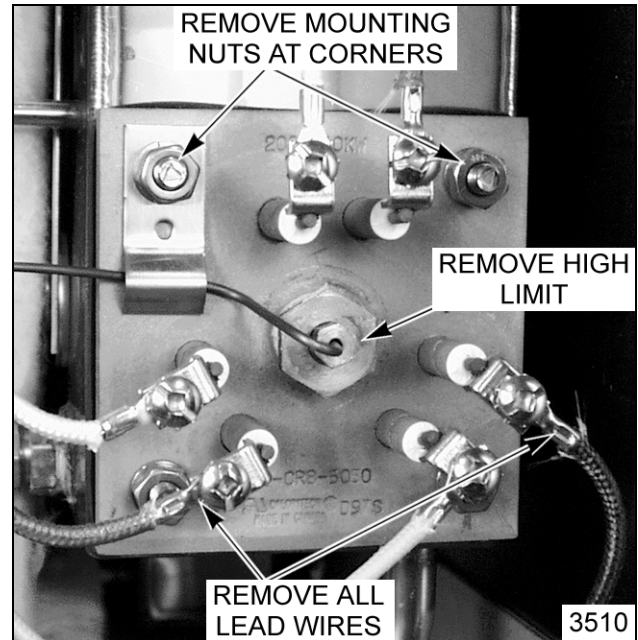

6. Reverse procedure to install.

## GAS SOLENOID VALVE

**WARNING:** DISCONNECT THE ELECTRICAL POWER TO THE MACHINE AT THE MAIN CIRCUIT BOX. PLACE A TAG ON THE CIRCUIT BOX INDICATING THE CIRCUIT IS BEING SERVICED.

**WARNING:** SHUT OFF THE GAS SUPPLY BEFORE SERVICING THE UNIT.

**WARNING:** ALL GAS JOINTS DISTURBED DURING SERVICING MUST BE CHECKED FOR LEAKS. CHECK USING A SOAP AND WATER SOLUTION (BUBBLES). DO NOT USE AN OPEN FLAME.

- A. BEFORE LIGHTING UNIT, CHECK ALL JOINTS PRIOR TO THE GAS VALVE (SOLENOID).
  - B. CHECK ALL JOINTS BEYOND GAS VALVE (SOLENOID) AFTER THE UNIT HAS LIT.
1. Remove the right side panel as outlined under "COVERS AND PANELS".
  2. Cut the wire ties around "wire bundle" and trace the solenoid wires to there terminations and remove.

3. Loosen the compression nuts on the flexible gas line then remove line from the gas solenoid valve and manifold.

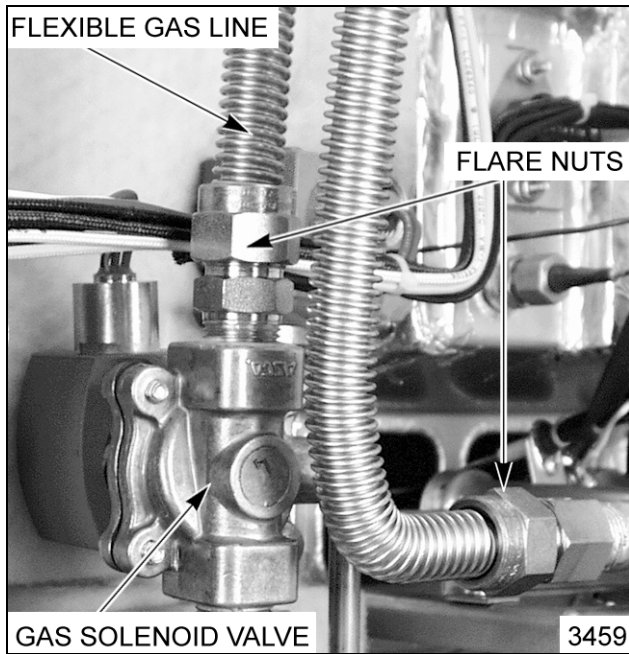

(VSX5G SHOWN)

4. If removing gas valve from a single unit, proceed to step 5. If removing gas solenoid valve from a double unit, proceed to step 6.
5. Turn "off" the water supply to the "tank fill" and "cold water condenser" solenoids and disconnect the fittings (bulkhead union) on the **opposite end** of the incoming water connections.
  - A. To access the compression fittings for the incoming water connection, remove the small access panel to the lower compartment.

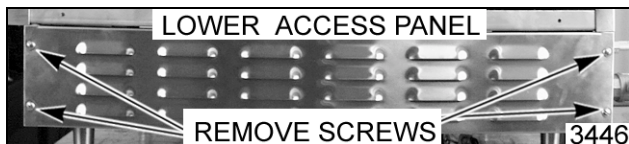

- B. Loosen the compression nuts on the "condenser feed" and "tank feed" water lines and place the lines to the side.

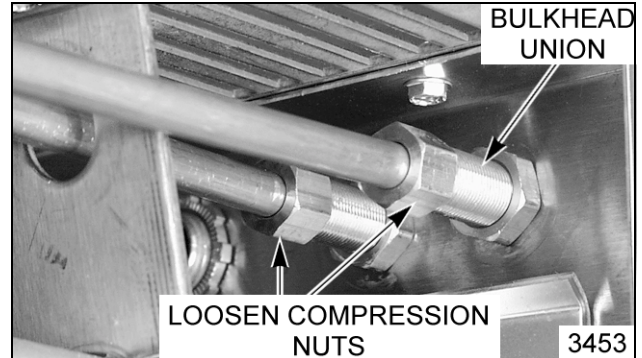

**NOTE:** If necessary, loosen the remaining compression nut on the "cold water condenser" solenoid and rotate it out of the way.

6. Open the lower cabinet base door to gain access the gas solenoid valves.

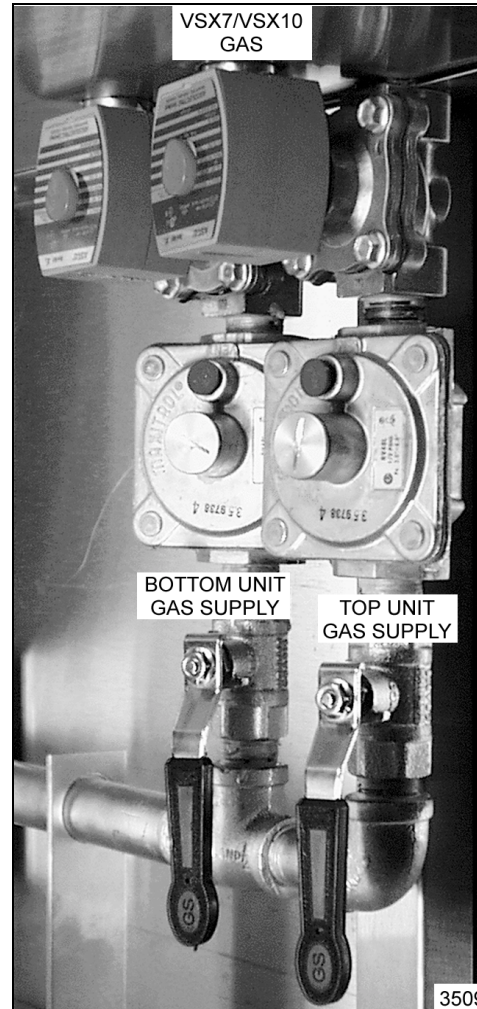

7. Remove the gas solenoid valve from the pipe nipple below it.
8. Reverse procedure to install and check unit for proper operation.

## GAS PRESSURE REGULATOR

**WARNING:** DISCONNECT THE ELECTRICAL POWER TO THE MACHINE AT THE MAIN CIRCUIT BOX. PLACE A TAG ON THE CIRCUIT BOX INDICATING THE CIRCUIT IS BEING SERVICED.

**WARNING:** SHUT OFF THE GAS SUPPLY BEFORE SERVICING THE UNIT.

**WARNING:** ALL GAS JOINTS DISTURBED DURING SERVICING MUST BE CHECKED FOR LEAKS. CHECK USING A SOAP AND WATER SOLUTION (BUBBLES). DO NOT USE AN OPEN FLAME.

- A. BEFORE LIGHTING UNIT, CHECK ALL JOINTS PRIOR TO THE GAS VALVE (SOLENOID).
  - B. CHECK ALL JOINTS BEYOND GAS VALVE (SOLENOID) AFTER THE UNIT HAS LIT.
1. Remove the right side panel as outlined under "COVERS AND PANELS".
  2. Remove the gas solenoid valve as outline under "GAS SOLENOID VALVE".
  3. Remove the gas pressure regulator from the pipe nipple below it.

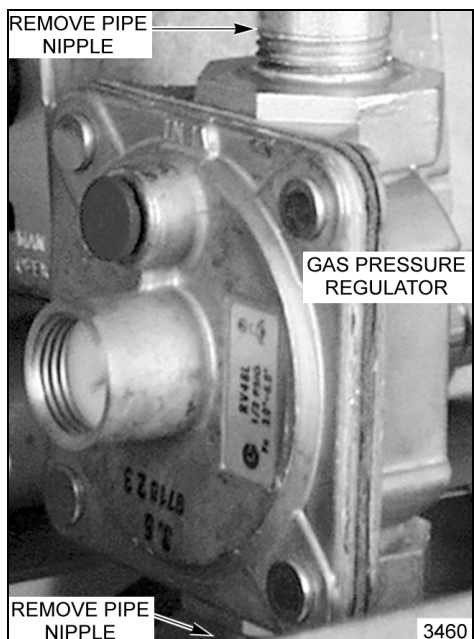

4. Reverse the procedure to install.
5. Adjust the gas regulator pressure as outlined under "MANIFOLD PRESSURE ADJUSTMENT".
6. Check unit for proper operation.

## FLAME SENSE PROBE (GAS)

**WARNING:** DISCONNECT THE ELECTRICAL POWER TO THE MACHINE AT THE MAIN CIRCUIT BOX. PLACE A TAG ON THE CIRCUIT BOX INDICATING THE CIRCUIT IS BEING SERVICED.

**WARNING:** SHUT OFF THE GAS SUPPLY BEFORE SERVICING THE UNIT.

1. Cut the wire ties around "wire bundle" and trace the Flame Sense Probe (FSP) wire to an in-line splice (butt connector) and cut the wire close to the connector.
2. Remove the screw holding the flame sense probe onto the mounting bracket and lift out.
3. Reverse the procedure to install a new probe then check FSP for proper operation as outlined under "FLAME SENSE PROBE".

**NOTE:** The opposite end of the in-line splice will have to be cut close to the connector and the wire insulation stripped back approximately 0.250 inch to install a new connector.

## WATER LEVEL CONTROL BOARD

**WARNING:** DISCONNECT THE ELECTRICAL POWER TO THE MACHINE AT THE MAIN CIRCUIT BOX. PLACE A TAG ON THE CIRCUIT BOX INDICATING THE CIRCUIT IS BEING SERVICED.

1. Remove the right side panel as outlined under "COVERS AND PANELS".
2. Disconnect the lead wires from the water level control board (WLC).
3. Remove mounting screws.
4. Move board to the left and rotate outwards when removing, to clear wire bundle.
5. Reverse the procedure to install, then check unit for proper operation.

## HOT SURFACE IGNITOR (GAS)

**WARNING:** DISCONNECT THE ELECTRICAL POWER TO THE MACHINE AT THE MAIN CIRCUIT BOX. PLACE A TAG ON THE CIRCUIT BOX INDICATING THE CIRCUIT IS BEING SERVICED.

**WARNING:** SHUT OFF THE GAS SUPPLY BEFORE SERVICING THE UNIT.

1. Remove the right side panel as outlined under "COVERS AND PANELS".
2. Cut the wire ties around "wire bundle" and trace the wire for the Hot Surface Ignitor (HSI) to an in-line splice (butt connector) and cut the wire off close to the connector.
3. Remove the screw that holds the flame sense probe and ground terminal wire onto the mounting bracket and lift out.
4. Reverse the procedure to install then check HSI for proper operation as outlined under "HOT SURFACE IGNITOR".

**NOTE:** The opposite end of the in-line splice will have to be cut, close to the connector and the wire insulation stripped back approximately 0.250 inch to install a new connector.

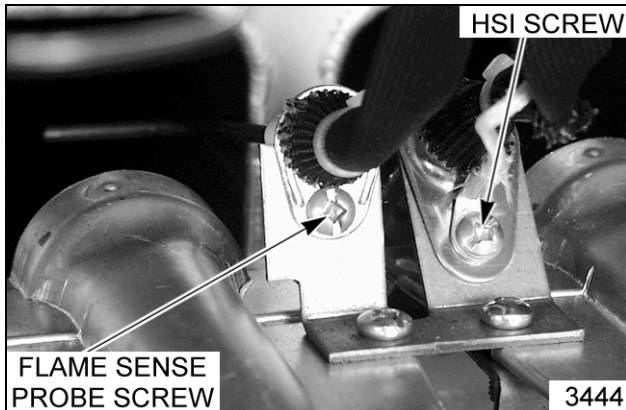

## GAS BURNER

**WARNING:** DISCONNECT THE ELECTRICAL POWER TO THE MACHINE AT THE MAIN CIRCUIT BOX. PLACE A TAG ON THE CIRCUIT BOX INDICATING THE CIRCUIT IS BEING SERVICED.

1. Remove the right side panel as outlined under "COVERS AND PANELS".
2. Remove the screws securing the burner mounting bracket to the burner box frame.
3. Slide the burner forward enough to clear the gas nozzles and lift it out.



4. Remove the screws securing the burners to the mounting bracket and lift the burners off.
5. Reverse procedure to install then check for proper operation.

**NOTE:** When checking for proper operation, make sure burner flame is not impinging on the opening of the burner box.

## GAS IGNITION MODULE

**WARNING:** DISCONNECT THE ELECTRICAL POWER TO THE MACHINE AT THE MAIN CIRCUIT BOX. PLACE A TAG ON THE CIRCUIT BOX INDICATING THE CIRCUIT IS BEING SERVICED.

1. Remove the right side panel as outlined under "COVERS AND PANELS".
2. Disconnect the control wires by pulling off wire harness connector located on the right side of module.
3. Remove screws that secure the module to the control board and lift off.



4. Reverse the procedure to install the new gas ignition module then check for proper operation.

## STEAM GENERATOR TANK

**WARNING:** DISCONNECT THE ELECTRICAL POWER TO THE MACHINE AT THE MAIN CIRCUIT BOX. PLACE A TAG ON THE CIRCUIT BOX INDICATING THE CIRCUIT IS BEING SERVICED.

1. Turn "off" the water supply and allow hot parts to cool down if necessary. On gas models, shut the gas supply "off" to the unit.
2. Remove the right side panel and top cover as outlined under "COVERS AND PANELS".

3. Manually drain steam generator tank if necessary, as outlined under "DRAIN TANK MANUALLY".
4. Disconnect the lead wire from each water level probe and then remove probes from tank. Mark probes accordingly for replacement.

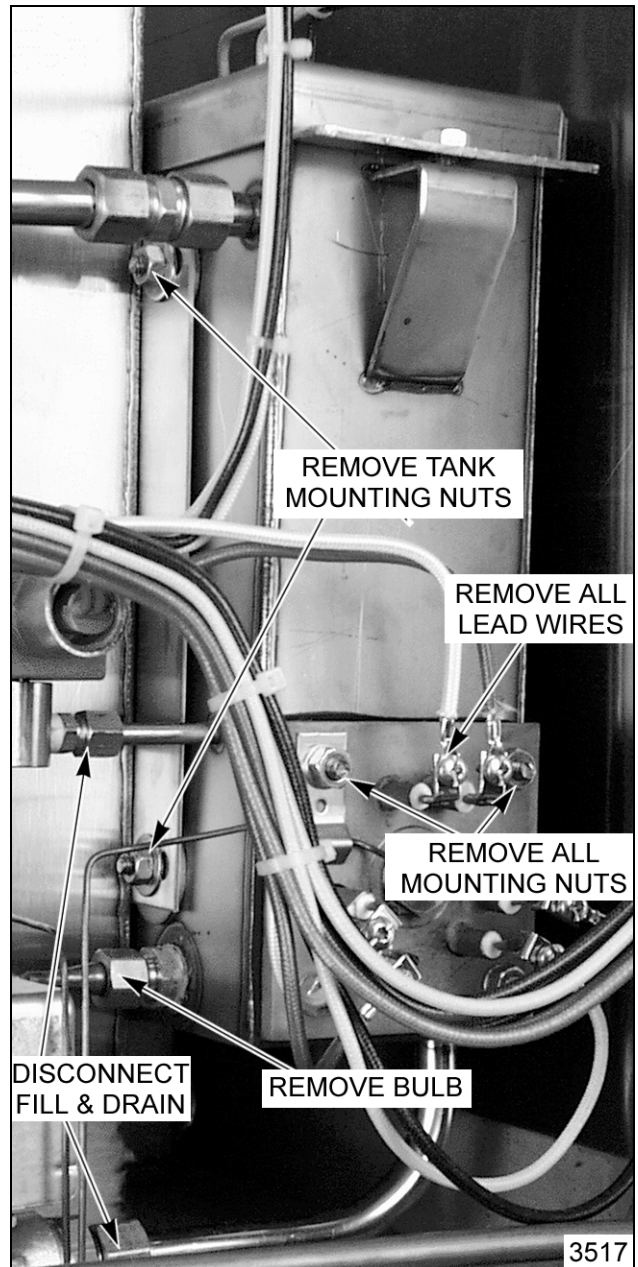

(Electric Model Shown)

5. Disconnect the steam lines on the top right and left side of the tank, the water fill tube, the drain line, then the delime line at the bottom left corner.

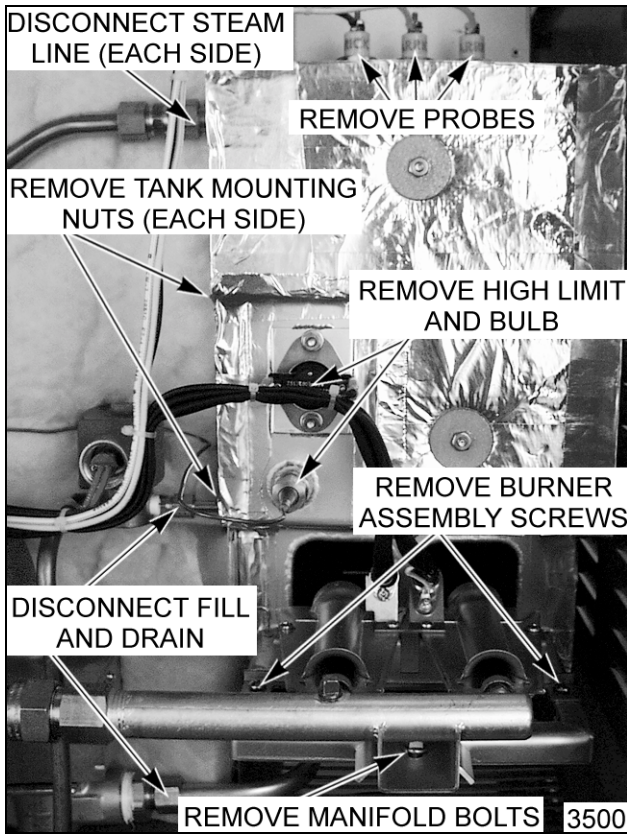

(Gas Model Shown)

6. Electric Models Only - For gas models proceed to step 7.
  - A. Remove the heater lead wires, control and high limit thermostat bulbs, then remove the heater from the tank.
  - B. To remove tank, loosen the nut on the left side mounting stud of the tank and remove the two nuts from the mounting studs on the right side of the tank.

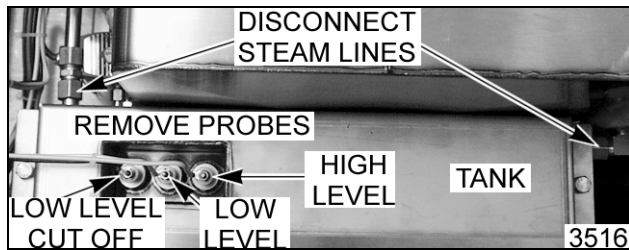

(Electric Model Shown)

- C. Push the right side of the tank toward the rear of the unit enough to clear the studs from the mounting bracket then, pull tank toward the right to remove.
- D. Reverse the procedure to install and check unit for proper operation.

7. Gas Model Only

- A. Remove the burner assembly and place to the side.
- B. Remove the bolts that secure the manifold to the burner box frame and place to the side.

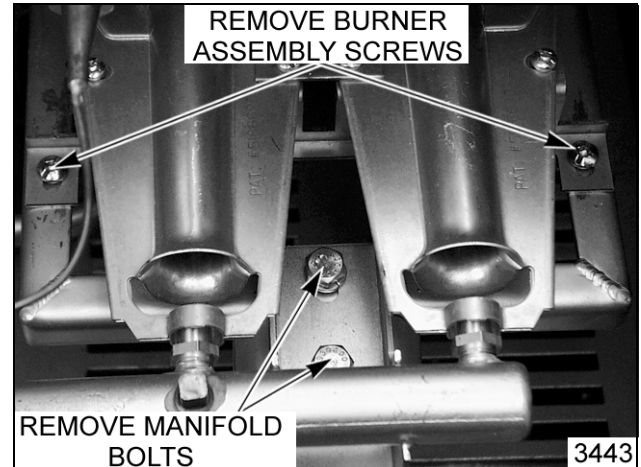

- C. Remove the surface high limit and the control thermostat bulb from the tank.
  - D. Remove the combination Left side and Rear panel as outlined under "COVERS AND PANELS".
8. Remove the nuts and washers from studs on each side of the tank that secure it to the steam cavity and lift the steam generator tank out.
  9. Reverse procedure to install and check unit for proper operation.

## WATER LEVEL PROBES

**WARNING:** DISCONNECT THE ELECTRICAL POWER TO THE MACHINE AT THE MAIN CIRCUIT BOX. PLACE A TAG ON THE CIRCUIT BOX INDICATING THE CIRCUIT IS BEING SERVICED.

1. Remove the top cover as outlined under "COVERS AND PANELS".
2. Disconnect the lead wire to water level probes.

3. Unscrew probes from steam generator tank.

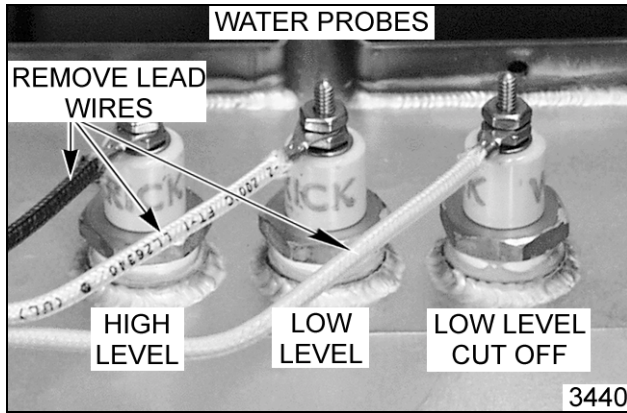

(Gas Model Shown)

**NOTE:** Probe should be cleaned thoroughly. Remove all accumulated deposits from the insulator using a soft cloth.

**NOTE:** Do not use anything abrasive on the insulators.

**NOTE:** If the probes are dirty, delime the unit after assembling.

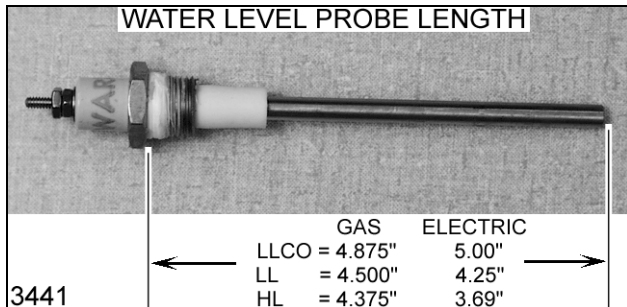

4. Reverse procedure to install.

**NOTE:** Perform a steam generator tank cleaning as outlined under "STEAM GENERATOR TANK CLEANING".

## FILL AND COLD WATER SOLENOID VALVES

**WARNING:** DISCONNECT THE ELECTRICAL POWER TO THE MACHINE AT THE MAIN CIRCUIT BOX. PLACE A TAG ON THE CIRCUIT BOX INDICATING THE CIRCUIT IS BEING SERVICED.

### Removal

1. Turn "off" the water supply to the steamer.
2. Remove the right side panel as outlined under "COVERS AND PANELS".

3. Cut the wire ties around "wire bundle" and trace the power wires for the solenoid valve being serviced back to there terminations and remove.
4. Disconnect the fittings on each side of the valve and remove the valve from the unit.
5. Reverse procedure to install.

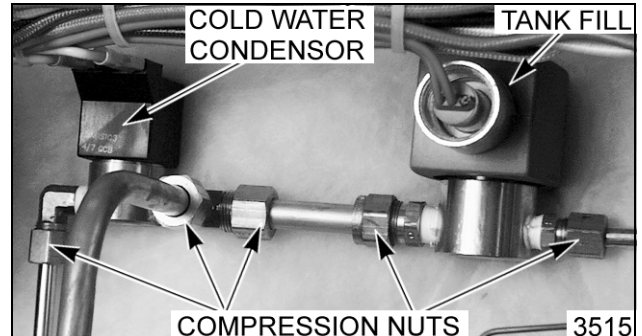

(Electric Model)

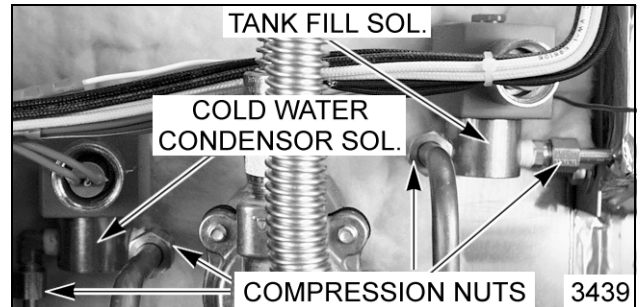

(Gas Model)

### Disassembly

**NOTE:** It is recommended that the valve be removed from the unit for cleaning to prevent damage to the lines and fittings when the stem is removed from the body.

1. Remove the coil assembly from the valve stem.
2. Disconnect the fittings on each side of the valve and remove it from the unit. Read note before removing.

**NOTE:** If a standard or adjustable spanner wrench that fits these solenoids is available, the body of the valve might be held with vise grips and then, remove the stem with your spanner wrench. If this can be done without damaging the line or fittings, proceed to step 5.

3. Clamp the body of the valve in a vise.
4. Mark a scribe line on the stem nut to the valve body for proper retightening.

5. Use a hammer and punch to turn the stem counterclockwise to remove the stem from the body.

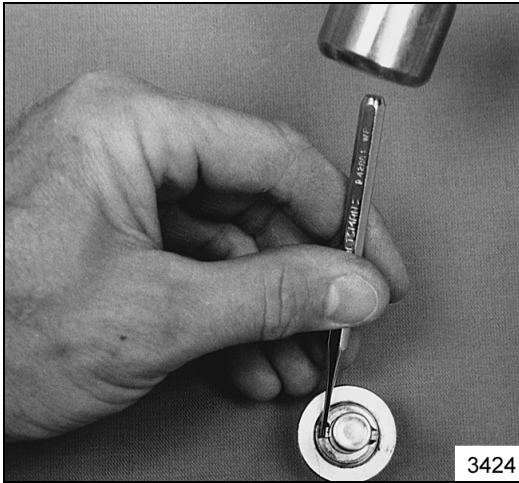

6. All parts are now accessible for inspection and cleaning.
  - A. Check rubber seal on bottom of plunger.
  - B. Check plunger spring.
  - C. Check "O"ring in valve body.
  - D. Check ports in valve body.

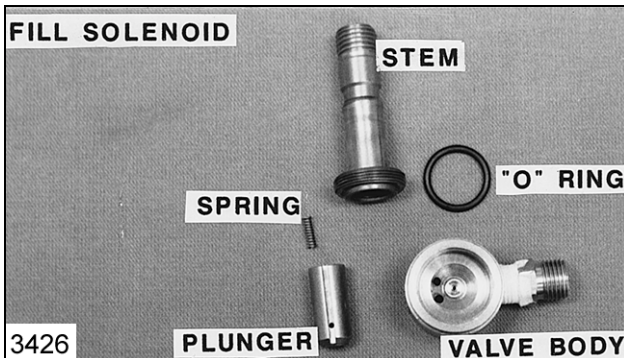
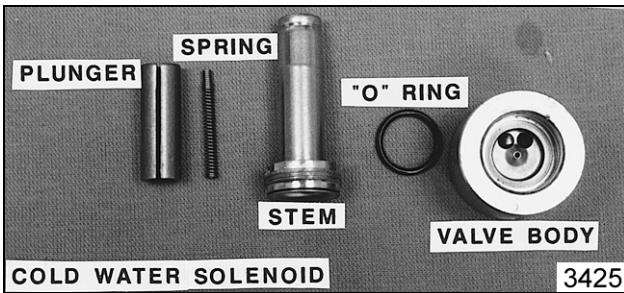

7. Reverse procedure to install.

## DRAIN VALVE

**WARNING:** DISCONNECT THE ELECTRICAL POWER TO THE MACHINE AT THE MAIN CIRCUIT BOX. PLACE A TAG ON THE CIRCUIT BOX INDICATING THE CIRCUIT IS BEING SERVICED.

### Removal

1. Turn "off" the water supply to the steamer.
2. Remove the right side panel and top cover as outlined under "COVERS AND PANELS".
3. Manually drain the steam generator tank if necessary, as outlined under "DRAIN TANK MANUALLY".
4. Disconnect the lead wires from the water level control and the ground wire from the control panel if necessary, to access the drain valve connections.
5. Disconnect the fittings on each side of the valve and remove the valve from the unit.

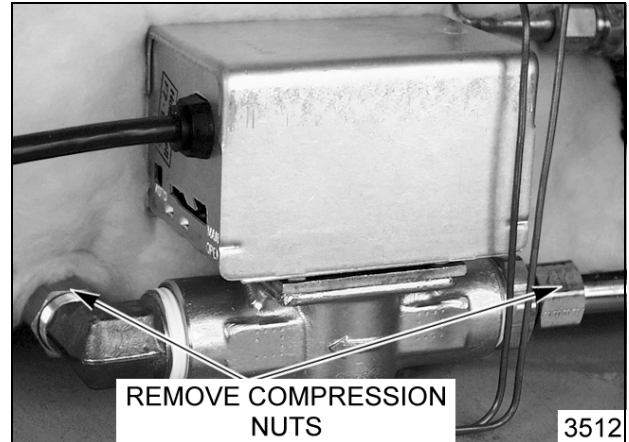

6. Reverse procedure to install.

### Disassembly

1. Turn "off" the water supply to the steamer.
2. Remove the right side panel as outlined under "COVERS AND PANELS".
3. Manually drain the steam generator tank if necessary, as outlined under "DRAIN TANK MANUALLY".
4. Remove the cover from the drain valve motor.

- Loosen the screws from the motor assembly and lift up on the motor to remove it from the valve body.

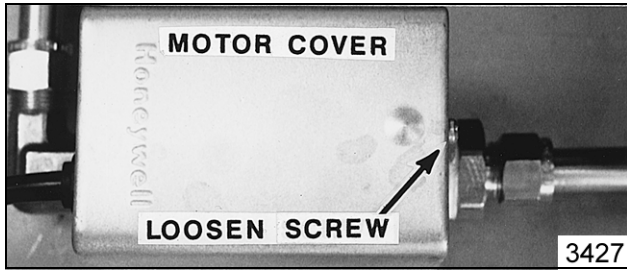

**NOTE:** When re-installing, place flat sides of ball stem perpendicular to the inlet and outlet of the drain valve. The valve will be in the open position whenever power is removed from the motor.

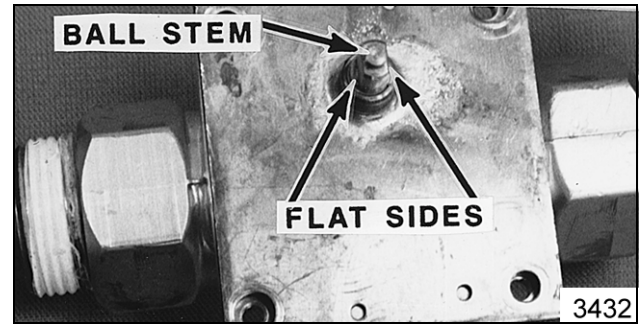
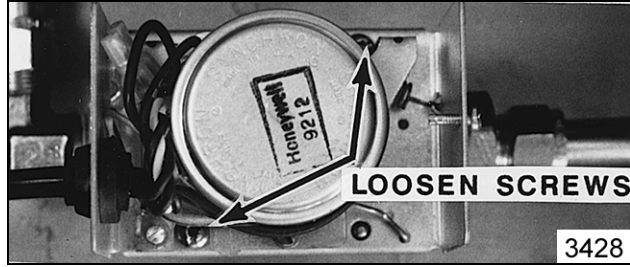
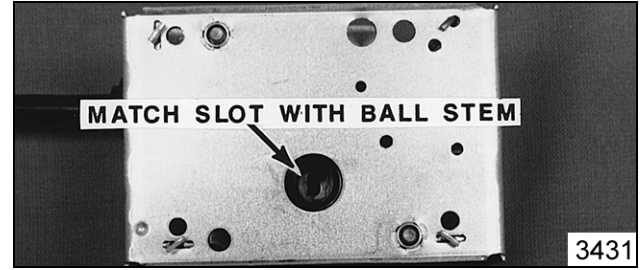

- Remove the screws from the cover plate and remove the cover plate and ball assembly from the valve body.

- Reverse procedure to install.

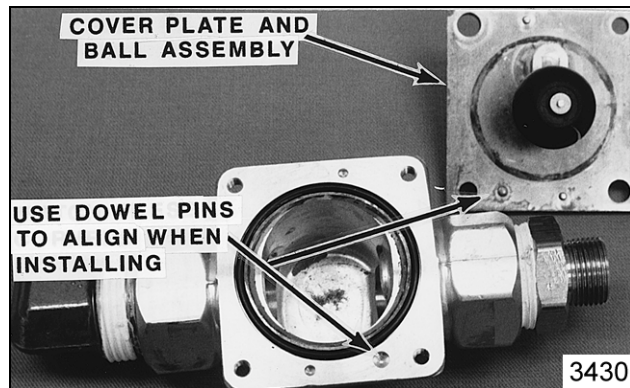
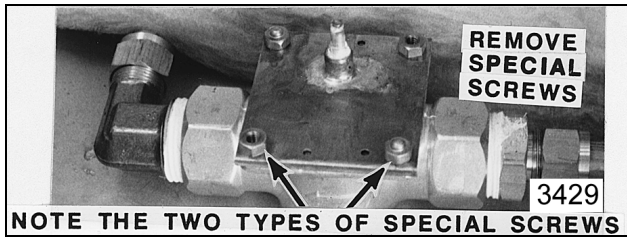

## DOOR

**WARNING:** DISCONNECT THE ELECTRICAL POWER TO THE MACHINE AT THE MAIN CIRCUIT BOX. PLACE A TAG ON THE CIRCUIT BOX INDICATING THE CIRCUIT IS BEING SERVICED.

### Removal

1. Remove top cover as outlined under "COVERS AND PANELS".
2. Open the door.
3. Pull hinge rod up.
4. Reverse the procedure to install, making sure the door bushings are in place.



### Gasket

1. Open the door.
2. Remove screws from the gasket plate.
3. Pull the gasket plate out from the door housing and remove the gasket.
4. Position the new gasket on the gasket plate and reverse the procedure to install. Adjust the door as outlined under "DOOR SEALING ADJUSTMENT".

**NOTE:** Do not over tighten gasket plate screws as this will compress the gasket excessively and interfere with proper door sealing.

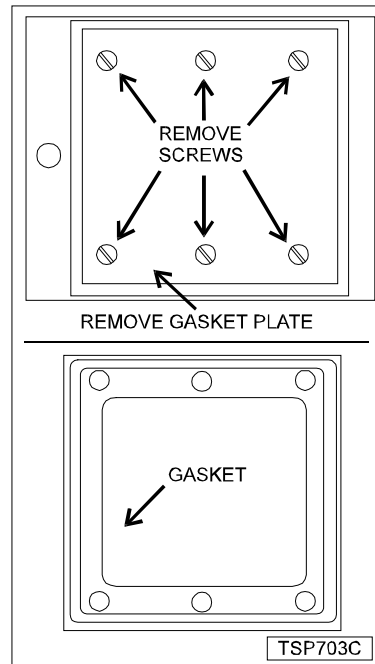

**Handle**

1. Open the door.
2. Remove screws from the top and bottom of the door.
3. Pull the "inner" door panel out from the door housing with the gasket plate and gasket still attached.



4. Remove the nuts and spacers from the handle screws and remove the handle from the door.

**NOTE:** When installing the spacers, the smaller diameter fits into the slot in the door and the latch lever must rest on top of the handle latch screw.

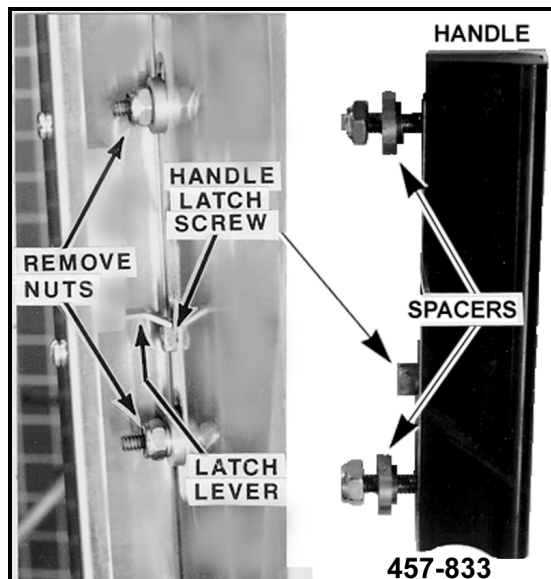

5. Reverse procedure to install.

**Latch Assembly**

1. Open the door.
2. Remove screws from the top and bottom of the door.
3. Pull the "inner" door panel out from the door housing with the gasket plate and gasket still attached.
4. Remove the screws from the side edge of the door that secure the latch mechanism and remove the latch from the door.



**NOTE:** When installing, the latch lever must rest on top of the handle latch screw.

5. Reverse procedure to install.

# SERVICE PROCEDURES AND ADJUSTMENTS

**WARNING:** CERTAIN PROCEDURES IN THIS SECTION REQUIRE ELECTRICAL TEST OR MEASUREMENTS WHILE POWER IS APPLIED TO THE MACHINE. EXERCISE EXTREME CAUTION AT ALL TIMES. IF TEST POINTS ARE NOT EASILY ACCESSIBLE, DISCONNECT POWER, ATTACH TEST EQUIPMENT AND REAPPLY POWER TO TEST.

## STEAM GENERATOR CLEANING

Follow the procedure as outlined in the "CLR TREATMENT KIT" to remove the Calcium/Lime/Rust build-up inside the tank, water level probes, electric elements and drain system.

The CLR Kit contains, C.L.R. cleaner, funnel, measuring cup, and 3/8" tubing.

In addition but not furnished in kit, rubber gloves should be used.

## DELIME BOARD OPERATION AND ADJUSTMENT

The delime timer board tracks the cumulative cooking hours and lights the delime light on the control panel when the delime timer board reaches a preset number of cooking hours. An LED on the delime timer board lights indicating cook time hours are accumulating.

After the delime timer board has accumulated the preset number of cooking hours, the delime light will light. It will stay lit until the power switch is moved to the delime position or off. If the power switch is turned "off" and then turned "on" without going to the delime position, the delime light will relight.

1. To adjust the length of cooking hours before the delime light will come on:
2. Access the delime timer board.

Position the switches in the "on" or "off" position to obtain the desired hours. The number of switches that are positioned "on" or "off" set the total hours. It does not matter which individual switch is "on" or "off".

		HRS	30	50	100	150	200
SWITCH POSITION	ON	0	1	2	3	ALL	
	OFF	ALL	3	2	1	0	

**NOTE:** Factory default time set on the board is 100 hrs.

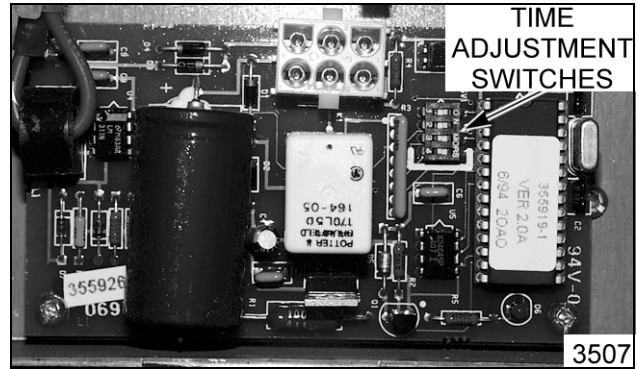

## CONTROL THERMOSTAT ADJUSTMENT

The procedure outlined below is to adjust the thermostat temperature setting to a "ready" state which is slightly below a continuous boil, (212°F) to achieve the best "cooking" and steamer performance.

When a cooking time is set on the timer, the delay time for the steam generator to deliver a high quality and volume of steam into the cooking compartment will be minimal.

Correctly identifying the amount of steam coming out of the ports is subjective. To help determine this, does the steam coming out of the ports exhibit the following:

1. Appear to be coming out under pressure.
2. Create a distinctive "whistling" sound during steaming.
3. Produce a good "cloud" of steam in the cooking compartment.

If the steaming meets the above criteria, the thermostat is set correctly.

1. Remove the right side panel as outlined under "COVERS AND PANELS."

2. Turn the thermostat adjustment stem fully clockwise for a starting position.

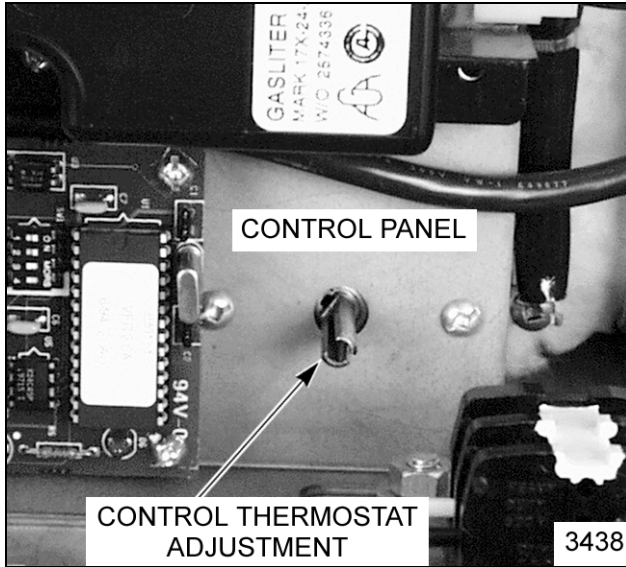

3. Open the water valve and turn the power switch "on."
4. Open the steam compartment door while the steam generator tank is heating up, and wait for "drift steam" to begin coming out of the steam ports. Approximate time 10 minutes.

**NOTE:** The door switch has no effect during preheat until thermostat temperature is satisfied and the "ready" light comes on.

5. Once "drift" steam is seen coming out of the steam ports, slowly turn the thermostat adjustment CCW until the thermostat "opens" and the ready light comes on.

**NOTE:** If water begins to drip "heavily" out of steam ports along with "drift" steam, then the tank water has reached too high of a temperature and is boiling. The thermostat setting must be adjusted down as indicated above.

6. With the door still open, set a time on the cook timer and depress the door switch button. Immediately after depressing the door switch button, begin counting the seconds until steam is "seen" coming out of the ports.
  - A. If it takes longer than time listed in the chart below, the thermostat setting is too low and must be increased. Proceed to step B.
  - B. Adjust the setting 1/8 of a turn CW to increase the set point temperature and repeat step 6 until steam exits the ports in the time listed.

MODEL	APPROXIMATE TIME FOR STEAM TO ENTER COMPARTMENT
ELECTRIC	5 sec.
GAS	13 sec.

**NOTE:** If after increasing the thermostat setting, the ready light stays "on" (heat not on) then the thermostat is still satisfied. To shorten the wait time until the heat comes on again, turn the power switch "off" for several seconds to drain some hot water out of the tank, then turn the switch back "on". At this point, the tank should begin filling with cold water, bringing the temperature down and causing the thermostat to call for heat. Repeat if necessary.

- C. If steam comes out of the ports like the steamer was in a "cooking mode" and the ready light never comes on, the set point temperature is too high. Proceed to step D.
- D. Adjust the setting 1/8 of a turn CCW to decrease temperature set point and repeat step 6 until steam exits the ports in the time listed.
- E. If steam comes out of the ports in the time listed above, then thermostat is set correctly.
- F. After adjusting the thermostat to its highest setting and steam does not come out of the ports as described, then replace the thermostat.

## DRAIN TANK MANUALLY

**WARNING:** DISCONNECT THE ELECTRICAL POWER TO THE MACHINE AT THE MAIN CIRCUIT BOX. PLACE A TAG ON THE CIRCUIT BOX INDICATING THE CIRCUIT IS BEING SERVICED.

1. Turn "off" the water supply to the steamer.
2. Remove the right side panel as outlined under "COVERS AND PANELS".
3. Remove the cover from the drain valve motor as outlined under "DRAIN VALVE".
4. Loosen the screws from the motor assembly and lift up on the motor to remove it from the valve body.
5. Turn the stem of the drain valve so that it is perpendicular to the inlet and outlet lines. This should drain the tank unless the drain line is clogged.

## DOOR SEALING ADJUSTMENT

1. Check the door gasket quality. If damaged or worn, replace as outlined under "DOOR".
2. Loosen screws until the screw heads no longer touch the gasket plate.
3. Tighten screws until screw head touches gasket plate and at that point begin counting turns.
4. Tighten all screws approximately two turns.
5. Close the door and check unit for proper operation.
6. If necessary, tighten all screws an additional ½ turn and repeat step 5.
7. Repeat step 6 until the door closes properly and no steam "leaks" are seen around the gasket seal.

## DOOR LATCH ADJUSTMENT

Should the cooker door jam and can not be opened, **DO NOT FORCE OR PRY** the door as damage will occur.

First, try lifting up on the bottom of the door at the handle end, to disengage the latch.

If that does not work, remove the right side panel. The striker that catches on the "door latch" is located behind the front face of the cooking cavity. Remove the nut from the striker and this will release it from the panel.

Once the nut and washer have been removed, door will open freely. Remove any burrs on the striker that may cause the latch to stick. Reinstall the striker and adjust, so door will not jam.

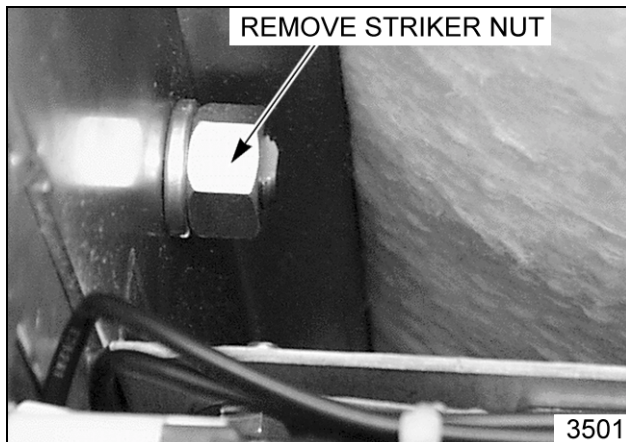

### To adjust:

1. Reinstall the striker with the slot pointing upwards and "hand tighten" nut only.
2. Close the door to center the striker in the oval mounting hole.
3. Open the door and check the strikers' slot for horizontal alignment. The slot on the striker must be kept horizontal in order for the door latch to catch it properly and latch.

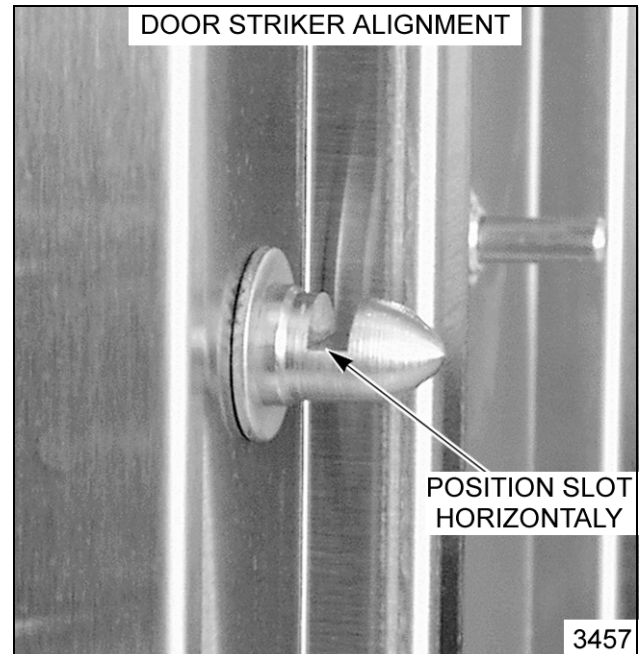

4. Once the proper slot alignment has been set, hold the striker close to its base using a rag and vise grips, then tighten the striker nut. Be careful not to damage the striker "slot" when tightening or door may not latch properly.

**NOTE:** Do not over tighten as the striker will begin to turn and change alignment.

## MANIFOLD PRESSURE ADJUSTMENT

**WARNING:** DISCONNECT THE ELECTRICAL POWER TO THE MACHINE AT THE MAIN CIRCUIT BOX. PLACE A TAG ON THE CIRCUIT BOX INDICATING THE CIRCUIT IS BEING SERVICED.

**WARNING:** SHUT OFF THE GAS SUPPLY BEFORE SERVICING THE UNIT.

1. Remove right side panel as outlined under "COVERS AND PANELS".
2. Remove the 1/4" NPT pipe plug from the manifold and attach a manometer.
3. Remove the adjustment screw cap to access the pressure adjustment screw.
  - A. To increase pressure, turn the screw clockwise
  - B. To decrease pressure, turn the screw counterclockwise

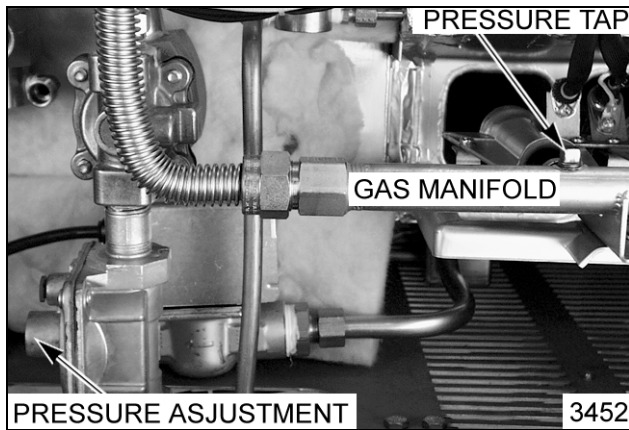

4. Plug in the unit, turn "on" the gas and set the power switch to "on". If adjusting pressure on a double unit, both must be "on" before a pressure adjustment is made.

**NOTE:** Accurate gas pressure adjustments can only be made with the gas "ON" and the burner lit.

5. After the burner lights, set the pressure as outline below:

PRESSURE READINGS (INCHES W.C.)				
GAS TYPE	MANIFOLD	LINE		
		RECOMMENDED	MIN	MAX
NATURAL	3.5	7.0	5.0	14
PROPANE	5.0	11.0	7.0	

\* If the incoming line pressure is **less than** the

minimum stated, then the manifold pressure can not be set correctly.

6. Once the correct pressure has been set, turn the power switch "off", replace the adjustment screw cap and manifold pipe plug.
7. Check unit for proper operation.

## FLAME SENSE PROBE (GAS)

**WARNING:** THE FOLLOWING STEPS REQUIRE POWER TO BE APPLIED TO THE UNIT DURING THE TEST. USE EXTREME CAUTION AT ALL TIMES.

1. Assure that the unit has a proper ground, correct polarity and that the value of incoming voltage is correct.
  - A. Check the flame sense voltage (burner on) between the flame sense lead wire termination in the ignition module edge connector and ground with a VOM set on DC volts. The voltage measurement will fluctuate but should be no less than 20 VDC.

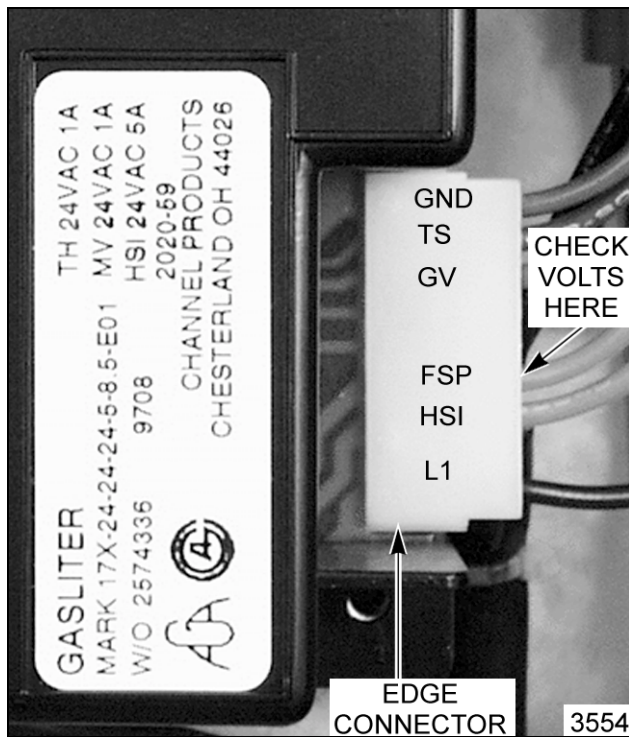

- B. If voltage is less than indicated, replace flame sense probe and check unit for proper operation.

2. Perform a visual check to determine if the flame sense probe is in the upper portion of flame. If the probe is bent or not in the upper portion of the flame then check for alignment and adjust as necessary.
  - A. The center line of the probe should be approximately  $1 \frac{15}{16}$  inches from the face of the burner and  $\frac{5}{16}$  inches up from the center line of the burner.

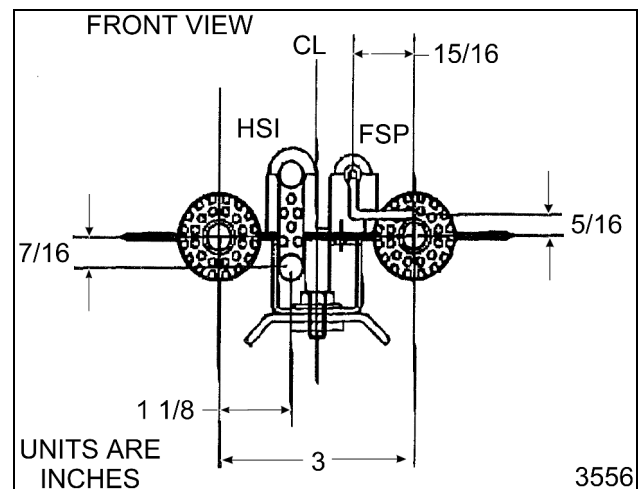
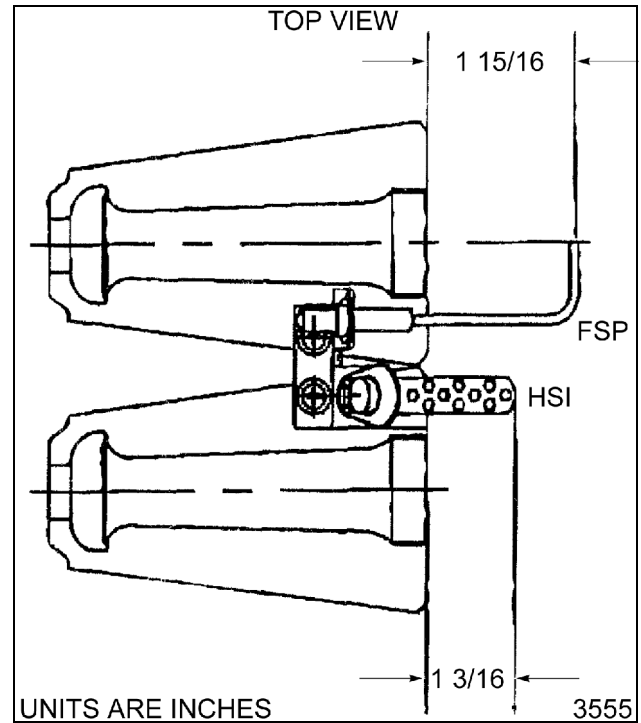

3. If no adjustments can be made to the probe to correct its alignment then replace and check unit for proper operation.

## HOT SURFACE IGNITOR (GAS)

1. Check to see if hot surface ignitor is operating during **ignition trial** by:
  - A. Visual verification - HSI should be heating up "glowing brightly" to ignite gas.
  - B. Voltage verification - check for 24VAC to HSI termination on the edge connector to ground.



**WARNING:** DISCONNECT THE ELECTRICAL POWER TO THE MACHINE AT THE MAIN CIRCUIT BOX. PLACE A TAG ON THE CIRCUIT BOX INDICATING THE CIRCUIT IS BEING SERVICED.

2. Unplug the edge connector from the ignition module and check resistance between HSI lead wire and ground.

HSI CONDITION	RESISTANCE (approx. Ohms)
COLD	1 - 4
HOT	8 - 10

## HEATING ELEMENT (ELECTRIC)

**WARNING:** THE FOLLOWING STEPS REQUIRE POWER TO BE APPLIED TO THE UNIT DURING THE TEST. USE EXTREME CAUTION AT ALL TIMES.

1. Check voltage at the heating element terminals.
  - A. If voltage is correct then proceed to step 2.
  - B. If voltage is not correct, check the following:
    - 1) Voltage supply to the unit.
      - a. Fuses or breaker blown.
      - b. Power to contactor coils.
      - c. Contactors not pulling in. (Mechanical)
2. Check current draw (amps) through the heating element lead wires using an amp clamp meter.
  - A. If current draw is correct then heating element is ok.
  - B. If current draw is not correct then proceed to step 3.
3. Remove the lead wires from the heating element and check the element resistance using a VOM.
  - A. If resistance readings are not correct, replace heating element.
4. Check unit for proper operation.

VOLTAGE	TOTAL KW	AMPERAGE PER LINE		RESISTANCE PER LINE (OHMS)
		1 PH	3 PH	
208	7.5	36.1	20.9	17.4
240	7.5	31.3	18.1	23.1
480	7.5		9.0	30.6
208	10	48.1	27.8	12.96
240	10	41.7	24.1	17.28
480	10		12.1	23.01
208	15	72.2	41.6	8.64
240	15	62.5	36.2	11.52
480	15		18.1	15.36

**NOTE:** Values in the table are nominal. Tolerance is +5/-10 %.

# ELECTRICAL OPERATION

## COMPONENT FUNCTION

- 1A Delime Timer Board** . . . Tracks the cumulative cooking hours by using a current sensor to monitor current flow through the cold water condenser solenoid lead, then signal's operator to perform delime procedure after the steamer has operated in cook mode for a preset number of hours.
- Buzzer** . . . . . Signals end of cook cycle, must be turned "off" manually.
- 1CON & 2CON**
- Heater Contactor** . . . . . Controls power to tank heaters. (electric models only)
- 1-3HTR Heaters** . . . . . Heat water in Steam Generator tank. (electric models only)
- 1K Relay** . . . . . Supplies power to control circuit when steam is being generated and the tank water level drops below the low level probe.
- 2K Relay** . . . . . Prevents operation of the cook timer until initial fill and heat is complete.
- 3K Relay** . . . . . Operates drain motor and resets delime timer board when the power switch is moved to the delime position.
- 1T** . . . . . Provides 12VAC power to the delime board.
- 2T** . . . . . Provides 24VAC power to ignition control module and HSI. (gas models only)
- Ignition Module** . . . . . Controls and monitors gas heating. Applies power to HSI for burner ignition, monitors flame presence through FSP, controls 5 second purge time and 8.5 second ignition trial time and powers gas solenoid valve. (gas models only)
- 1LT Ready Light** . . . . . Indicates steam generator tank is up to temperature and cooking can begin.
- 2LT Delime Light** . . . . . Indicates preset number of cook time hours have accumulated and the tank should be delimited.
- 3LT Cook Light** . . . . . Indicates cook timer has been set and a cook cycle is in process.
- 4LT Ignition Light** . . . . . Indicates gas burner is on. (gas models only)
- High Level Probe** . . . . . Monitors tank water level and signals the WLC when tank is full.
- Low Level Probe** . . . . . Keeps the WLC relay coil HL energized when the water level drops below the high level probe.
- Low Level Cut Off Probe** . . . Monitors tank water level and removes electrical power to the LLCO relay when the water level drops below the low level cut off probe.
- FSP (Flame Sense Probe)** . . Supplies a current signal back to the ignition module indicating the presence of a flame. (gas models only)
- HSI (Hot Surface Igniter)** . . When Ignition module applies power, the element heats up to very high temperatures causing gas ignition. (gas models only)
- 1M Drain Motor** . . . . . Controls the tank drain. (normally open valve, water flows when de-energized)

- 1S Power Switch** . . . . . Controls electrical power to the control circuit and delime circuit.
- 2S Door Switch** . . . . . Removes electrical power to the timer when the door is opened and the control thermostat is open.
- 1SOL Fill Solenoid** . . . . . Controls tank water supply. (normally closed valve, water flows when energized)
- 2SOL Cold Water Solenoid** . Controls cold water supply going into drain to mix and condense exhaust steam. (normally closed valve, water flows when energized)
- GAS Valve Solenoid** . . . . . Allows gas flow to burner when solenoid is energized. A normally closed valve. (gas models only)
  
- 1TAS High Limit Thermostat** . . . . . Will not allow heater contactor (on electric models) or ignition module (on gas models) to energize if the tank temperature goes beyond 125°C (257°F).
- 2TAS Control Thermostat** . . On electric models it cycles power to heater contactors. On gas models it cycles power to the ignition control module. On either model, this will maintain the steam generator tank set point temperature, when no time is on cook timer.
- 1TR Timer** . . . . . On electric models it controls the cold water solenoid and power to the heater contactors. On gas models it controls the cold water solenoid and power to the ignition control module. This occurs on either model after the tank reaches its set point temperature and time is dialed into the timer. Also, energizes the buzzer when time expires.
  
- WLC (Water Level Control Board)** . . . . . Monitors water level probes to control the tank water level and heater contactors. Individual LED's on board light up when water level reaches LLCO and then HL probes. When water level drops below one of these probes, LED goes out.

**COMPONENT LOCATION**

**Electric Models**

**VSX3E, 4E & 5E**

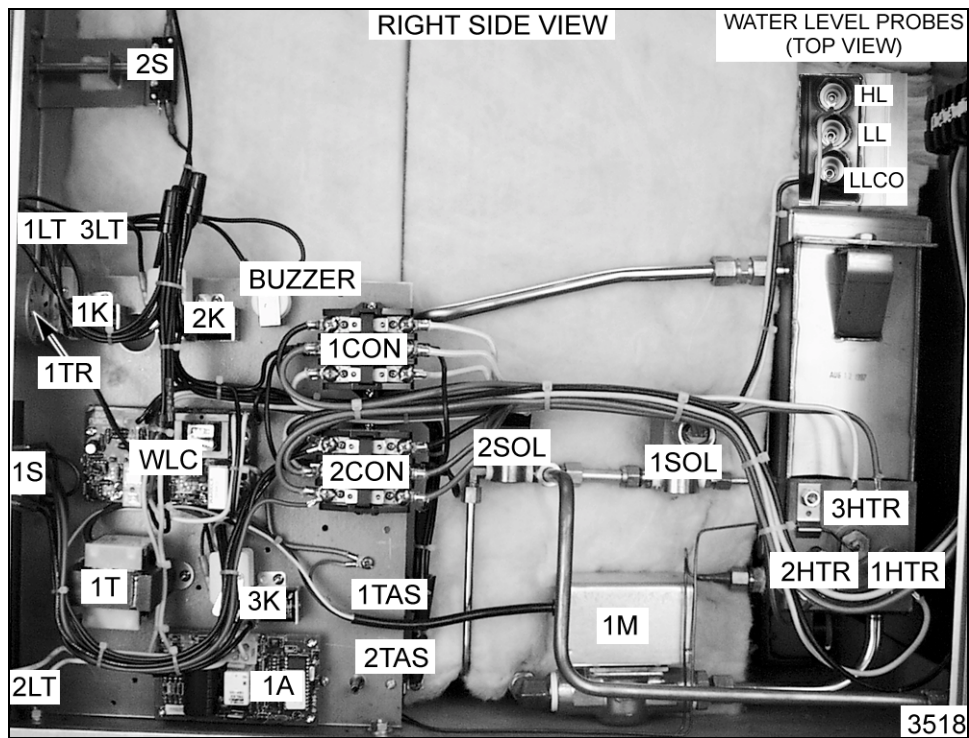

**VSX7E & 10E**

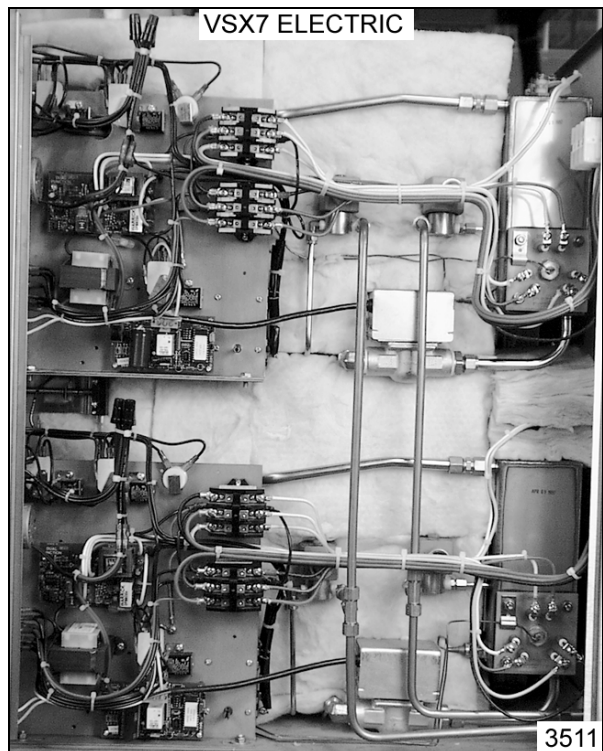

Gas Models

VSX5G

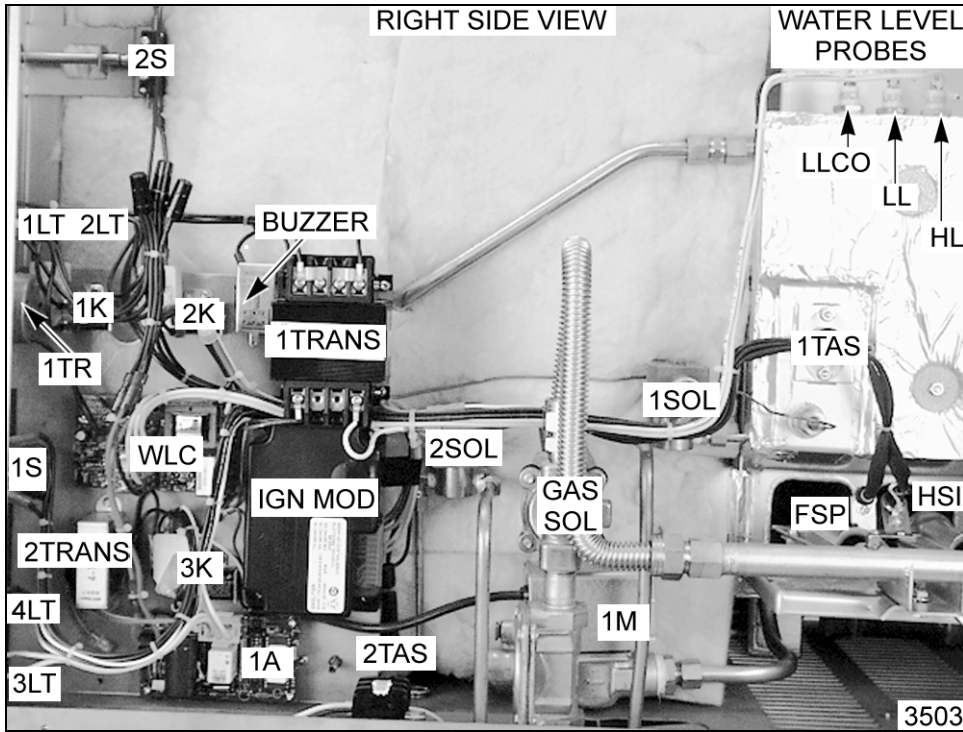

VSX 7G & 10G

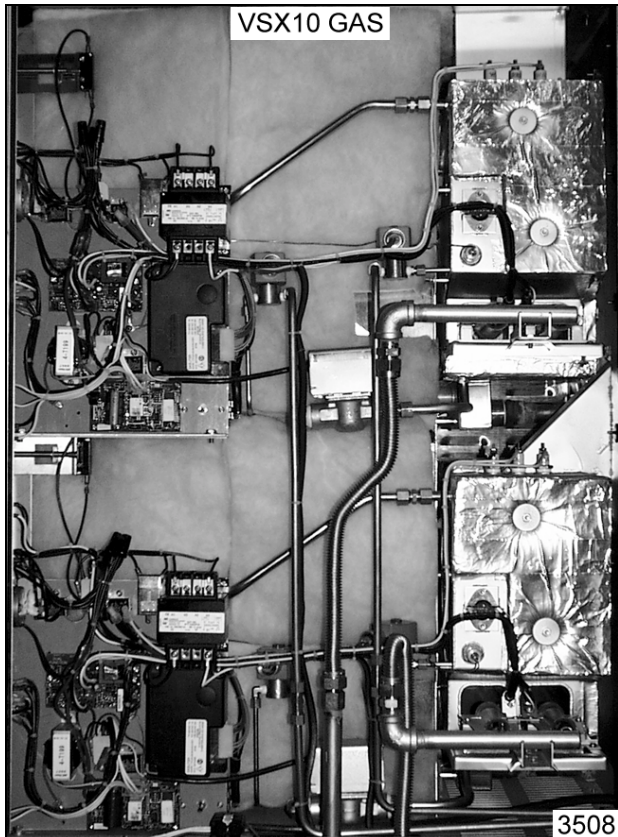

## WATER LEVEL CONTROL OPERATION

The water level control (WLC) has line voltage across terminals 11 and 12 which powers the primary side of the transformer. The secondary side of the transformer provides power to the control by a series path through chassis ground; through the water in the steam generator tank; through the water level probes; to the internal relay coils on the control. The other side of the secondary winding is attached to the control that directs the power to the other side of the internal relay coils. As water enters the tank, the water becomes part of the circuit. As the water level reaches the probes, the circuit with that particular probe is completed to the water level control, thus energizing the internal relay coil. LED's on the board for LLCO and HL relays will illuminate as the water level reaches each of these probes. When the water level drops below the LL probe, the HL relay LED will go out until the water level reaches the HL probe again. This LED will go on and off during a cook cycle as the tank water level raises and lowers. The LLCO LED will only go out if the water level drops below the low level probe.

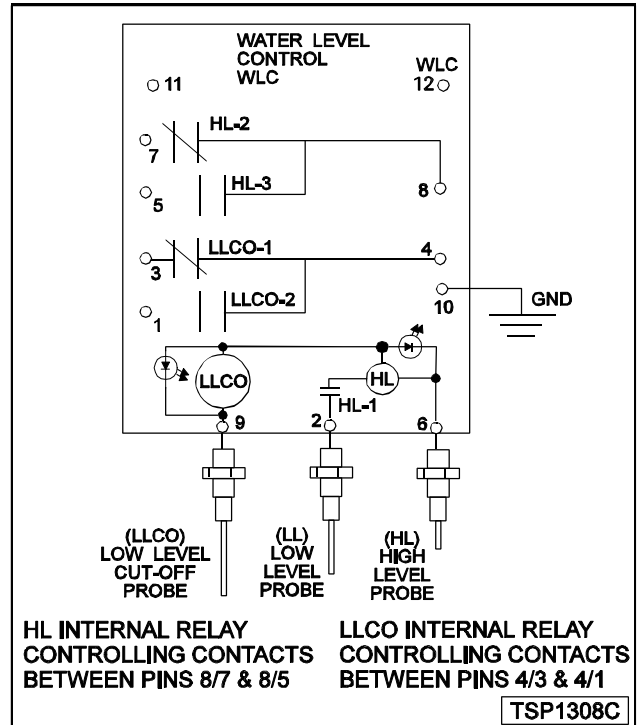
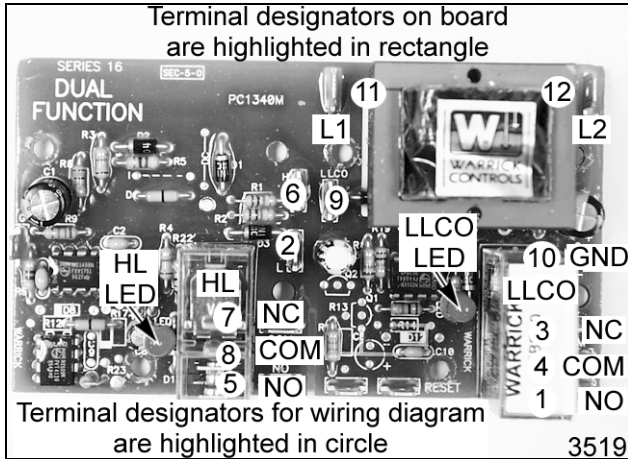

## SEQUENCE OF OPERATION

### ELECTRIC MODELS

#### INITIAL FILL & PREHEAT

1. Conditions.
  - A. Unit connected to correct voltage.
  - B. Supply water valve "on".
  - C. Power switch "off".
  - D. High limit thermostat closed.
  - E. Control Thermostat closed.
  - F. Drain open and steam generator tank (referred to as tank) empty.
  - G. Door closed.
2. Power switch turned "on".
  - A. L1 voltage to one side of 1M; Pin 11, WLC; 1SOL, 1K; 2K; 1CON; 2CON; 2LT; 2SOL; BUZZER; TM.
  - B. L3 voltage to one side of 1M, drain motor; pins 4,8 & 12 of water level control.
    - 1) 1M drain motor energized; drain valve closed.
    - 2) 1SOL energized thru HL-2; Water flows to tank.
3. Water reaches LLCO probe.
  - H. Timer "off".
  - I. Tank and WLC properly grounded. (share common ground)

- A. LLCO energizes.
  - 1) Contacts LLCO-1 open; LLCO-2 close.
  - 2) LLCO LED lights.
- 4. Water reaches LL (Low Level) probe.
- 5. Water reaches HL (High Level) probe.
  - A. Internal relay HL energizes.
  - B. HL LED lights.
  - C. Internal relay coil HL locks through HL-1.
- 6. 1SOL de-energized; water flow off.
  - A. After the initial fill, the water level is maintained by 1SOL being energized when the water level drops below the LL probe and being de-energized when the water level reaches the HL probe. This will not affect operation of either the preheat or cook cycle due to 1K being energized and locked during the initial fill.
  - B. 1K energized and locks 1K coil when 1K NO/C close.
  - C. 2K energized thru 2TAS, 1K-NO/C, WLC-LLCO-2.
  - D. 1CON and 2CON energized thru 2K-2 NO/C, 2TAS, 1K-NO/C, WLC-LLCO-2.
- 7. Heaters are energized.
- 8. Tank temperature reaches set point.
  - A. 2TAS opens.
- 9. 2K de-energized.
  - A. 1CON & 2CON de-energized.
  - B. Heaters de-energized.
  - C. 1LT ready light energized thru 1CON & 2CON coils to indicate tank is at hold temperature. 1LT uses bleed through voltage.
- 10. Tank temperature drops below set point.
  - A. Tank temperature is maintained by the heaters cycling with control thermostat 2TAS until time is dialed on the timer, water level drops below the low level cut-off probe or the power switch is turned "off".
  - B. 1LT ready light goes out.
- 11. Water level drops below LL probe.
  - A. Internal relay HL de-energized, contacts HL-1 open; HL-2 close; HL-3 open.
    - 1) Power is removed from the heating and cooking circuits.

**COOK CYCLE**

- 1. Cook cycle can not start until the initial fill and preheat is completed and the door is closed.
  - A. 2K-1 (NC/C) contacts are open during preheat and will prevent operation of the timer, buzzer, 2SOL and 2LT.
- 2. Ready light lit.

- A. Product is inserted into steamer.
- B. Door is closed.
- C. Time is dialed on the timer.
- 3. Contacts 1/3 of timer close.
  - A. 1CON and 2CON are energized by the closing of 1TR 1/3 contacts and thru 2K-2 NC/C contacts.
 

**NOTE:** Heaters are not controlled by 2TAS and are on continuously during the cook cycle.

    - B. Ready light goes out.
    - C. Cook light lights.
    - D. 2SOL energized and water flows to drain to condense steam.
    - E. Timer motor energized.
    - F. Delime timer board begins to monitor cooking hours.
- 4. Time expires on timer.
  - A. Timer contacts 1/3 open, 2LT de-energized.
  - B. Timer contacts 4/1 close and energize buzzer until manually turned "off".
  - C. Timer motor de-energized.
  - D. 2SOL de-energized and water is shut off from drain.
  - E. 1CON and 2CON de-energized and are controlled by 2TAS.
- 5. Steamer reverts to preheat cycle until time is dialed into timer and the door is shut, water level drops below low level cut-off probe or the power switch is turned "off".

**WATER REFILL (AFTER INITIAL FILL)**

**NOTE:** This water refill cycle will not affect operation of either the preheat or cook cycle due to 1K being energized and locked during the initial fill.

- 1. Water level drops below low level probe (LL).
  - A. WLC internal coil HL de-energized.
    - 1) WLC contacts HL-3 open.
    - 2) WLC contacts HL-2 close.
- 2. 1SOL energized, water flows.
- 3. Water reaches LL (Low Level) probe.
  - A. Power to pin 2 of water level control.
- 4. Water reaches high level probe.
  - A. Internal coil HL of water level control is energized.
    - 1) WLC HL-2 opens.
    - 2) WLC HL-3 closes.
    - 3) WLC HL-1 close.
- 5. 1SOL de-energized.
- 6. The water refill cycle will occur whenever the water level is below the low level probe.

## DELIME CYCLE

1. Steamer is in a cook cycle where the delime board monitors the cook time.
2. Delime light comes on.
  - A. Cook cycle ends and product removed.
3. Power switch turned to delime position.
4. 3K energized.
  - A. Contacts 3K-1 NO close.
  - B. 1M energized and drain closes.
  - C. Delime board transformer energized.
  - D. Contacts 3K-1 NC open.
  - E. Contacts 3K-2 NO close.
    - 1) Delime time is reset to "0".
5. Turn steamer off and perform delime procedure.

## GAS MODELS

### INITIAL FILL & PREHEAT

1. Conditions.
  - A. Unit connected to correct voltage.
  - B. Supply water valve "on".
  - C. Gas supply valve "on".
  - D. Power switch "off".
  - E. High limit thermostat closed.
  - F. Control Thermostat closed.
  - G. Drain open and tank empty.
  - H. Door closed.
  - I. Timer "off".
  - J. Tank and WLC properly grounded (share common ground).
2. Power switch turned "on".
  - A. L1 (120VAC) to one side of 1M; Pin 11, WLC; 1SOL, 1K; 2K; 2LT; 2SOL; BUZZER; TM; 1T which in turn supplies 24VAC to one side of Ignition Module, TH, 4LT and Gas Valve.
  - B. NEUTRAL (120VAC) to one side of 1M, drain motor; pins 4,8 & 12 of water level control.
    - 1) 1M drain motor energized; drain valve closed.
    - 2) 1SOL energized thru HL-2; Water flows to tank.
3. Water reaches LLCO probe.
  - A. LLCO energizes.
    - 1) Contacts LLCO-1 open; LLCO-2 close.
    - 2) LLCO LED lights.
4. Water reaches LL (Low Level) probe.
5. Water reaches HL (High Level) probe.

- A. Internal relay HL energize.
- B. HL LED lights.
- C. Internal relay coil HL locks through HL-1.
6. 1SOL de-energized; water flow off.
  - A. After the initial fill, the water level is maintained by 1SOL being energized when the water level drops below the LL probe and being de-energized when the water level reaches the HL probe. This will not affect operation of either the preheat or cook cycle due to 1K being energized and locked during the initial fill.
  - B. 1K energized and locks 1K coil when 1K NO/C close.
  - C. 2K energized thru 2TAS, 1K-NO/C, WLC-LLCO-2.
  - D. Ignition Module energized thru 2K-2 NO/C, 2TAS, 1K-NO/C, WLC-LLCO-2.
7. After the ignition module is energized, ignition trial cycle begins.
  - A. Module purges for 5 seconds to allow time for any residual gas to dissipate. After purge time elapses, HSI begins a 3 second heat up time.
  - B. When HSI heat up time elapses, the gas solenoid valve opens to supply gas to the hot ignitor.
  - C. Burner will light, flame sense probe detects flame, HSI de-energizes after an 8.5 second ignition trial time, gas valve stays open and heating begins.
8. Tank temperature reaches set point.
  - A. 2TAS opens.
9. 2K de-energized.
  - A. Ignition Module de-energized.
    - 1) Burners off.
  - B. 1LT ready light energized, indicating tank is at hold temperature. 1LT uses bleed through voltage.
10. Tank temperature drops below set point.
  - A. Tank temperature is maintained by the burners cycling with control thermostat 2TAS until time is dialed on the timer, water level drops below the low level cut-off probe or the power switch is turned "off".
  - B. 1LT ready light goes out.
11. Water level drops below LL probe.
  - A. Internal relay HL de-energized, contacts HL-1 open; HL-2 close; HL-3 open.
    - 1) Power is removed from the heating and cooking circuits.

**COOK CYCLE**

1. Cook cycle can not start until the initial fill and preheat is completed and the door is closed.
  - A. 2K-1 (NC/C) contacts are open during preheat and will prevent operation of the timer, buzzer, 2SOL and 2LT.
2. Ready light lit.
  - A. Product is inserted into steamer.
  - B. Door is closed.
  - C. Time is dialed on the timer.
3. Contacts 1/3 of timer close.
  - A. Ignition module is energized by the closing of 1TR 1/3 contacts and thru 2K-2 NC/C contacts. The ignition trial cycle begins, burners come on.
 

**NOTE:** Ignition module power is not controlled by 2TAS during a cook cycle therefore the burners will stay on continuously during cooking.
  - B. Ready light goes out.
  - C. Cook light lights.
  - D. 2SOL energized and water flows to drain to condense steam.
  - E. Timer motor energized.
  - F. Delime timer board starts monitoring cooking hours.
4. Time expires on timer.
  - A. Timer contacts 1/3 open, 2LT de-energized.
  - B. Timer contacts 4/1 close and energize buzzer until manually turned "off".
  - C. Timer motor de-energized.
  - D. 2SOL de-energized and water is shut off from drain.
  - E. Ignition Module de-energized and is controlled by 2TAS.
  - F. Delime timer board stops monitoring cooking hours.
5. Steamer reverts to preheat cycle until time is dialed into timer and the door is shut, water level drops below low level cut-off probe or the power switch is turned "off".

**WATER REFILL (AFTER INITIAL FILL)**

**NOTE:** This water refill cycle will not affect operation of either the preheat or cook cycle due to 1K being energized and locked during the initial fill.

1. Water level drops below low level probe (LL).
  - A. WLC internal coil HL de-energized.
    - 1) WLC contacts HL-3 open.
    - 2) WLC contacts HL-2 close.
2. 1SOL energized, water flows.
3. Water reaches LL (Low Level) probe.

- A. Power to pin 2 of water level control.
4. Water reaches high level probe.
  - A. Internal coil HL of water level control is energized.
    - 1) WLC HL-2 opens.
    - 2) WLC HL-3 closes.
    - 3) WLC HL-1 close.
5. 1SOL de-energized.
6. The water refill cycle will occur whenever the water level is below the low level probe.

**DELIME CYCLE**

1. Steamer is in a cook cycle where the delime board monitors the cook time.
2. Delime light comes on.
  - A. Cook cycle ends and product removed.
3. Power switch turned to delime position.
4. 3K energized.
  - A. Contacts 3K-1 NO close.
  - B. 1M energized and drain closes.
  - C. Delime board transformer energized.
  - D. Contacts 3K-1 NC open.
  - E. Contacts 3K-2 NO close.
    - 1) Delime time is reset to "0".
5. Turn steamer off and perform delime procedure.

**SCHEMATIC ELECTRIC STEAMERS**

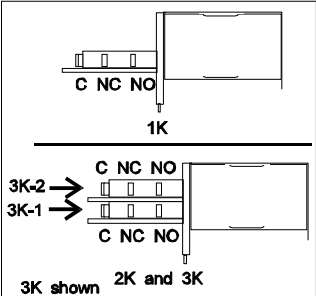
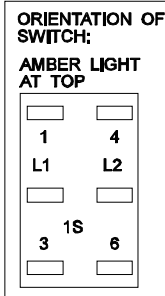
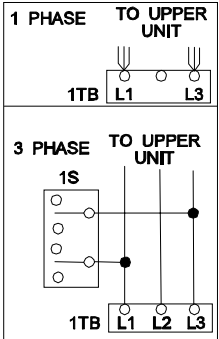
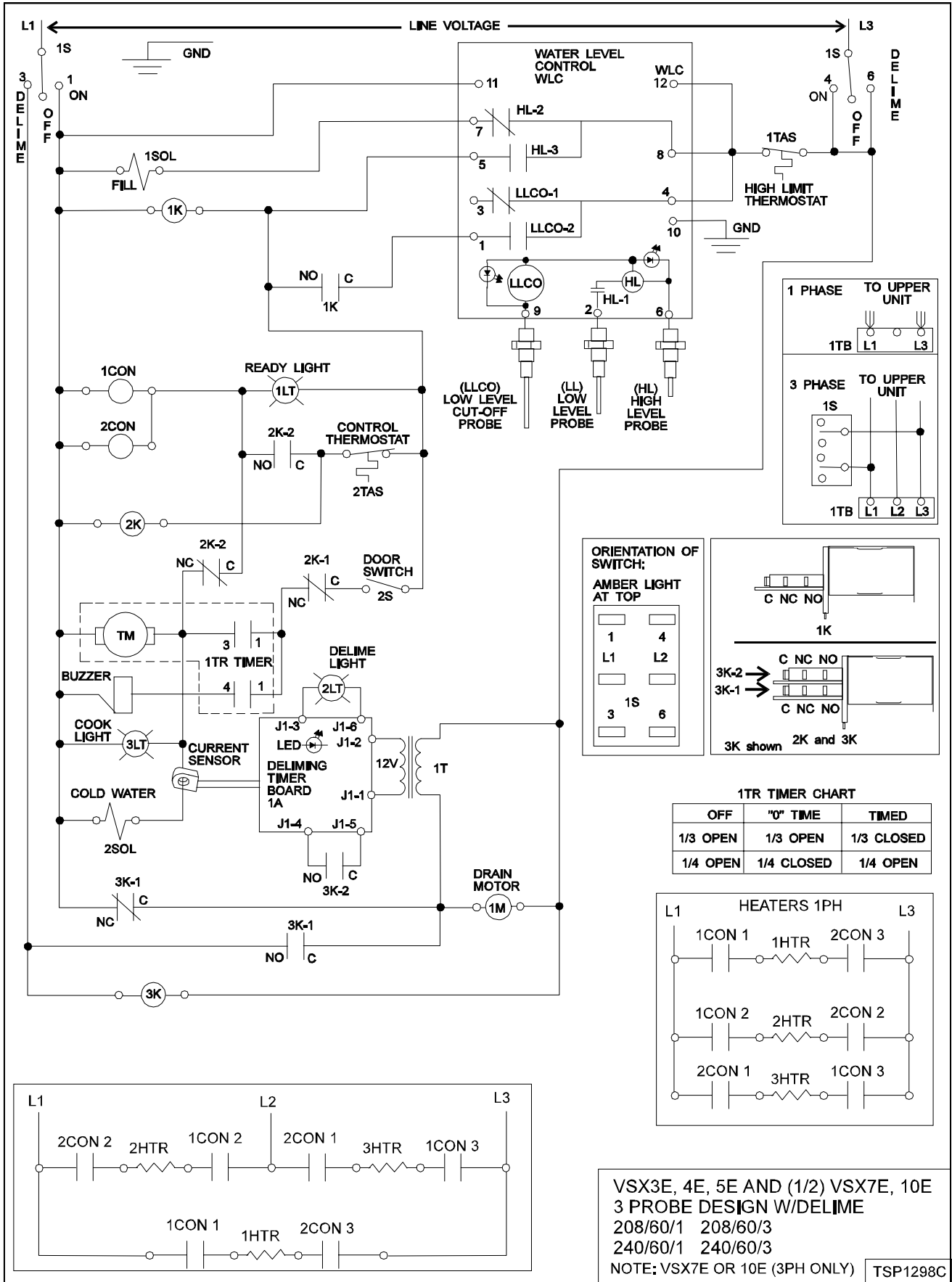

**1TR TIMER CHART**

OFF	"0" TIME	TIMED
1/3 OPEN	1/3 OPEN	1/3 CLOSED
1/4 OPEN	1/4 CLOSED	1/4 OPEN

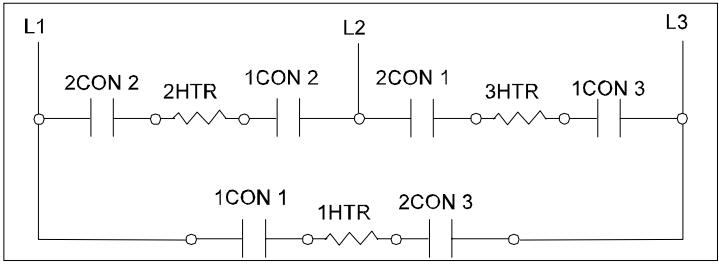
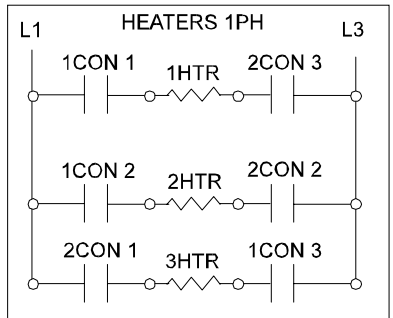

VSX3E, 4E, 5E AND (1/2) VSX7E, 10E  
 3 PROBE DESIGN W/DELIME  
 208/60/1 208/60/3  
 240/60/1 240/60/3  
 NOTE: VSX7E OR 10E (3PH ONLY) TSP1298C





**WIRING DIAGRAM GAS STEAMERS**

**VSX5G, OR (1/2) VSX7G, 10G**

TO UPPER UNIT ↑

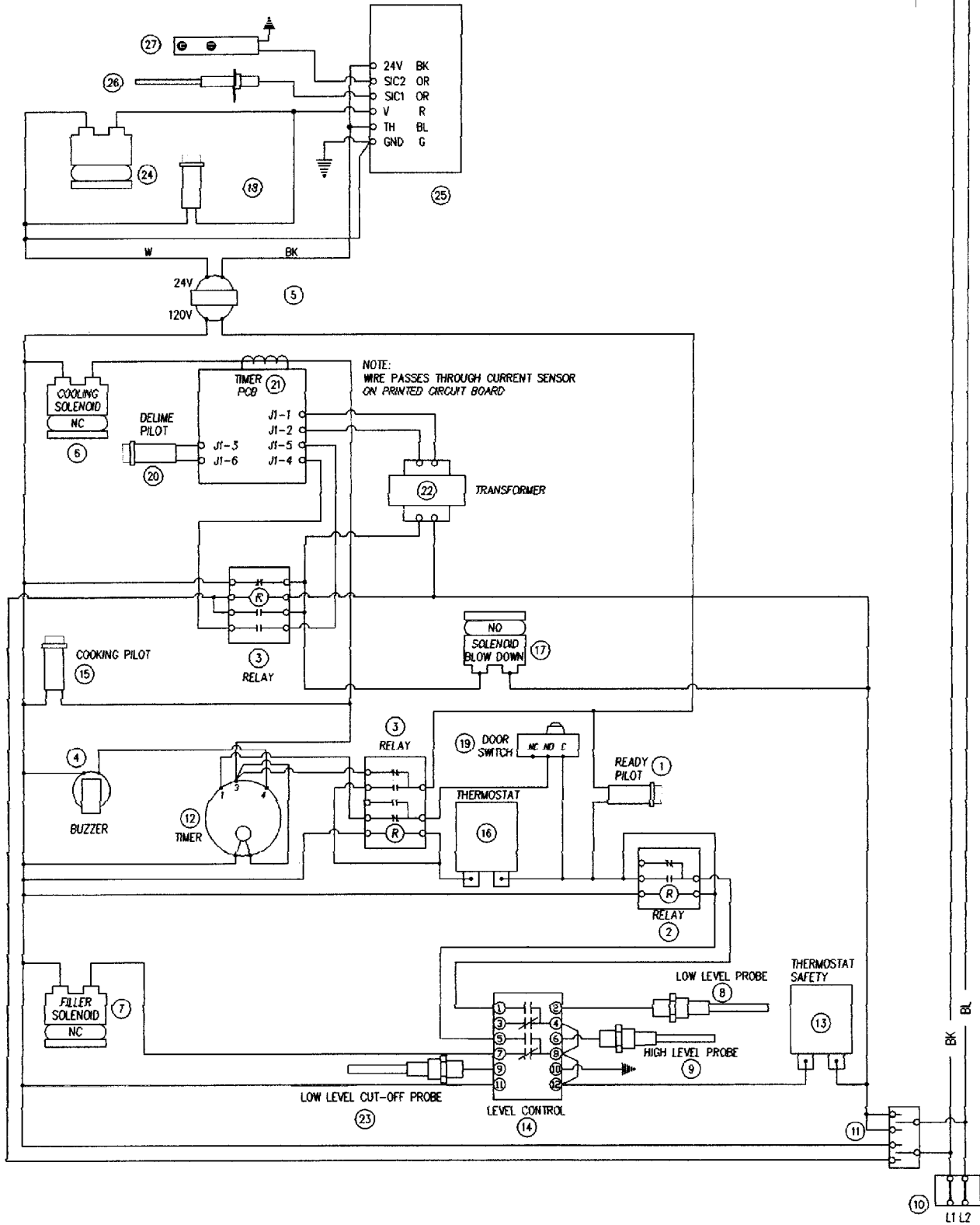

3547

# TROUBLESHOOTING

## ALL MODELS

**WARNING:** CERTAIN PROCEDURES IN THIS SECTION REQUIRE ELECTRICAL TESTS OR MEASUREMENTS WHILE POWER IS APPLIED TO THE MACHINE. EXERCISE EXTREME CAUTION AT ALL TIMES. IF TEST POINTS ARE NOT EASILY ACCESSIBLE, DISCONNECT POWER, ATTACH TEST EQUIPMENT AND REAPPLY POWER TO TEST.

SYMPTOM	POSSIBLE CAUSES
Compartment leaks water around door.	<ol style="list-style-type: none"> <li>1. Unit not level.</li> <li>2. Drain line obstructed or not to an open gap drain.</li> </ol>
Cold water condenser not operating properly.	<ol style="list-style-type: none"> <li>1. 2SOL inoperative or plugged.</li> <li>2. Lack of water supply.</li> </ol>
Steam leaks around door.	<ol style="list-style-type: none"> <li>1. Worn gasket - See "DOOR" in "SERVICE PROCEDURES AND ADJUSTMENTS".</li> <li>2. Damaged gasket.</li> <li>3. Drain line obstructed or not to an open drain.</li> </ol>
Steam generated inside compartment when timer is off.	<ol style="list-style-type: none"> <li>1. 2TAS control thermostat malfunction or not adjusted.</li> </ol>
Steam leaking inside shell.	<ol style="list-style-type: none"> <li>1. Tank gasket not sealing.</li> <li>2. Loose steam line.</li> </ol>
Heat coming on without water in tank.	<ol style="list-style-type: none"> <li>1. Dirty high level probe (shorted to ground).</li> <li>2. Retention of water in probe guard.</li> <li>3. 1K stuck closed.</li> <li>4. WLC-5/8 stuck closed.</li> </ol>
Unit will not heat (Ready light off).	<ol style="list-style-type: none"> <li>1. Check incoming voltage.</li> <li>2. Tank not filled.</li> <li>3. Power switch malfunction.</li> <li>4. Water Level Control malfunction.</li> <li>5. 1K inoperative.</li> <li>6. High limit thermostat open (1TAS).</li> <li>7. Heating element inoperative (electric only).</li> <li>8. 1CON or 2CON malfunction.</li> <li>9. Control thermostat open (2TAS).</li> <li>10. Relay 2K malfunction.</li> <li>11. Water too "pure" for probes to properly conduct electricity.</li> </ol>
Unit leaks water.	<ol style="list-style-type: none"> <li>1. Loose water, steam or drain line connections.</li> </ol>
Tank water level too high.	<ol style="list-style-type: none"> <li>1. Fill solenoid 1SOL does not shut off.</li> <li>2. High level probe malfunction (open circuit).</li> <li>3. Water level control inoperative (WLC).</li> </ol>

<b>SYMPTOM</b>	<b>POSSIBLE CAUSES</b>
Tank does not fill.	<ol style="list-style-type: none"> <li>1. Water supply not on.</li> <li>2. Fill solenoid 1SOL not opening or plugged.</li> <li>3. Water level control malfunction (WLC).</li> <li>4. Water level probes shorted to ground.</li> </ol>
Timer motor does not run.	<ol style="list-style-type: none"> <li>1. Door open or door switch 2S inoperative.</li> <li>2. 2K-1 NC/C contacts not closing.</li> <li>3. Timer inoperative.</li> </ol>
Water running out of drain during fill or when the power switch 1S is off.	<ol style="list-style-type: none"> <li>1. 1SOL stuck open.</li> <li>2. 2SOL stuck open.</li> </ol>
Delime light does not reset after power switch has been moved to de-lime position.	<ol style="list-style-type: none"> <li>1. Relay 3K-2 open.</li> <li>2. Delime timer board malfunction.</li> </ol>
Delime timer board LED is not lit when time is dialed into cook timer.	<ol style="list-style-type: none"> <li>1. NC contacts of 3K-1 open.</li> <li>2. Transformer inoperative.</li> <li>3. Current sensor malfunction.</li> <li>4. Delime timer board malfunction.</li> </ol>
Delime light does not light after pre-set time. (Delime timer board LED lights.)	<ol style="list-style-type: none"> <li>1. Delime light open.</li> <li>2. Delime timer board malfunction.</li> </ol>
Door not closing properly.	<ol style="list-style-type: none"> <li>1. Door latch assembly.</li> <li>2. Striker adjustment.</li> </ol>
Door won't open.	<ol style="list-style-type: none"> <li>1. Latch won't release see "DOOR LATCH ADJUSTMENT" in "SERVICE PROCEDURES AND ADJUSTMENTS".</li> </ol>
Buzzer not operating.	<ol style="list-style-type: none"> <li>1. Timer malfunction.</li> <li>2. Buzzer malfunction.</li> </ol>

**GAS MODELS ONLY**

<b>SYMPTOM</b>	<b>POSSIBLE CAUSES</b>
Burner won't light.	<ol style="list-style-type: none"> <li>1. Gas not "on".</li> <li>2. Low incoming gas pressure.</li> <li>3. HSI not operating see "HOT SURFACE IGNITOR" in "SERVICE PROCEDURES AND ADJUSTMENTS".</li> <li>4. Unit not properly grounded and/or polarity of incoming power is incorrect.</li> <li>5. Ignition module not receiving power. Check 2T for 24VAC output to module.</li> <li>6. Ignition module malfunctioning.</li> </ol>
Burner won't stay lit.	<ol style="list-style-type: none"> <li>1. Gas pressure low see "GAS PRESSURE ADJUSTMENT" in "SERVICE PROCEDURES AND ADJUSTMENTS".</li> <li>2. Check position of flame sense probe see "FLAME SENSE PROBE" in SERVICE PROCEDURES AND ADJUSTMENTS".</li> <li>3. Flame sense probe malfunction.</li> <li>4. Ignition module malfunction.</li> <li>5. Check gas orifice for obstruction.</li> </ol>
HSI heats up but gas will not light.	<ol style="list-style-type: none"> <li>1. Gas supply is off.</li> <li>2. Gas valve (solenoid) malfunction.</li> <li>3. Ignition module not receiving power. Check 2T for 24VAC output to module.</li> <li>4. Ignition module malfunction.</li> </ol>