



REPLACEMENT PARTS

ITEM NO.	PART NUMBER	DESCRIPTION	69507 QTY.	69522 QTY.
1	352360-2	Top Glass Assembly	1	1
2	250805-1	Foot	6	6
3	352357-2	Coil Tray Subassembly	1	1
4	250457-1	Large DC Fan Guard	2	2
5	352367-2	DC Fan Kit - Extended Wires	1	1
6	250455-1	AC Blower	1	1
7	250854-1	69507 Mylar	1	0
	250858-1	69522 Mylar	0	1
8	354537-2	EMI & Power Board Kit 69507	1	0
	352359-1	EMI & Power Board Kit 69522	0	1
9	250312-1	VOLLRATH LED UNITS	2	2
10	250557-1	RIBBON CABLE	2	2
11	250944-1	50 AMP POWER CORD	1	0
	250551-1	30 AMP POWER CORD	0	1
12	352555-1	3/4" STRAIN RELIEF AND LOCK NUT KIT	1	1

ITEM 10 NOT SHOWN

FASTENERS (GENERAL SPECIFICATION)

ITEM NO.	DESCRIPTION
13	SCREW - MACHINE, M5X12MM, W/ LOCK WASHER
14	SCREW - SHEET METAL, M4X12MM, SELF-TAPPING
15	SCREW - MACHINE, M4X35MM
16	NUT-HEX, M4, NYLON INSERT
17	SCREW, M4X10MM
18	SCREW, 10-32 X 1/2"
19	SCREW, 6-32 X 1/4"
20	SCREW, M4X8MM

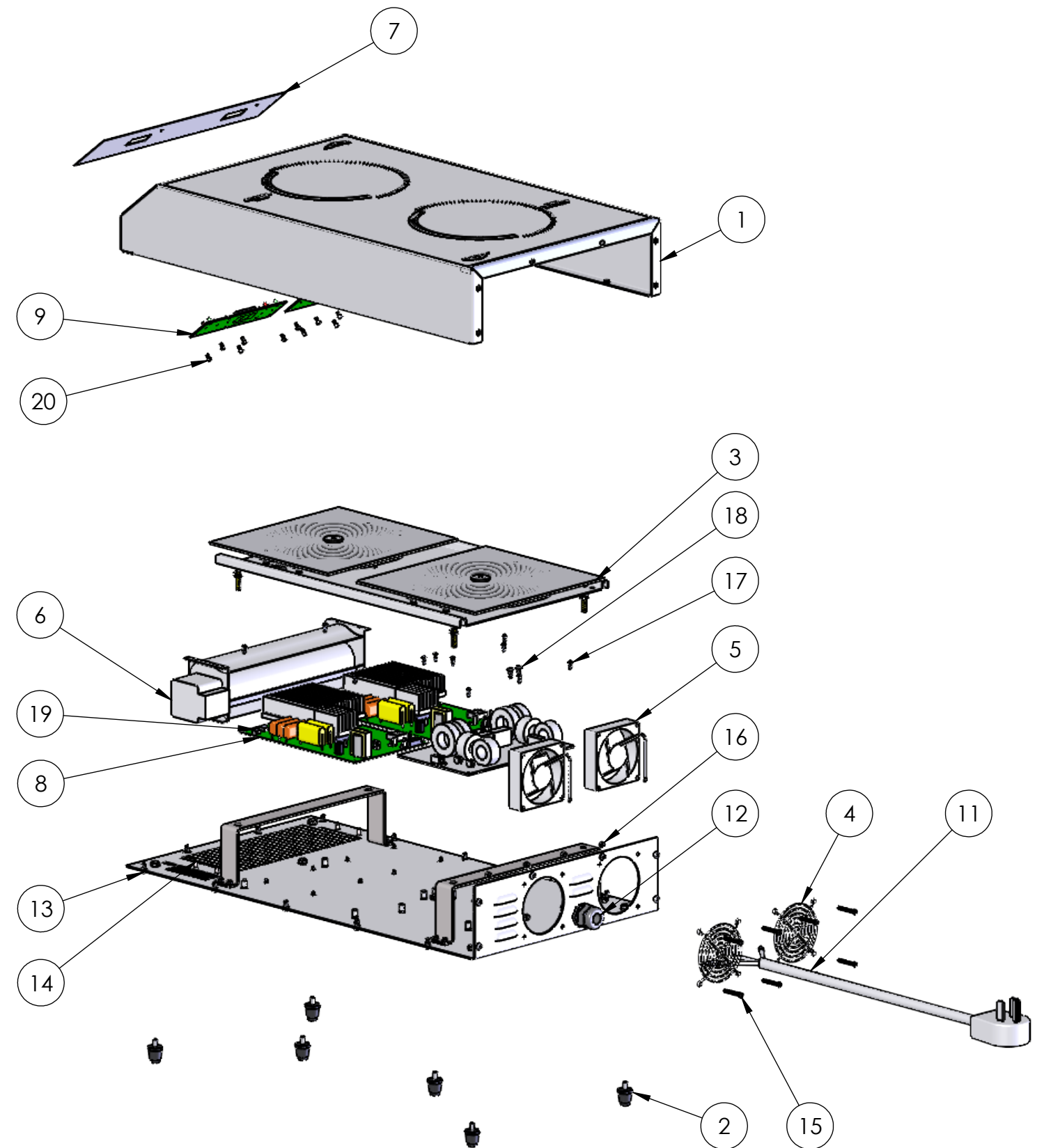

OPENING THE UNIT VOIDS WARRANTY