

032218
2mm - 5/64"
Fine Grating Disc

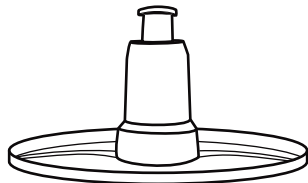

032583
Sealed
Whipping Disc

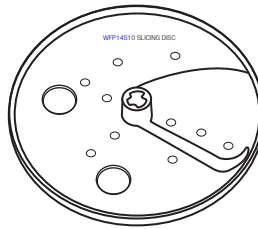

032523
Adjustable Slicing Disc

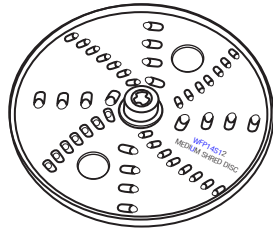

032527
Reversible Shredding Disc

WARING COMMERCIAL

3.5 Qt. Food Processors

WFP14S
sealed batch bowl

WFP14SC
sealed batch bowl and continuous feed

Unit Information

6 Amps MAX
3.5 Quart Bowl
1 HP Motor
5 Yr Motor - 2 Yr
Parts & Labor Warranty

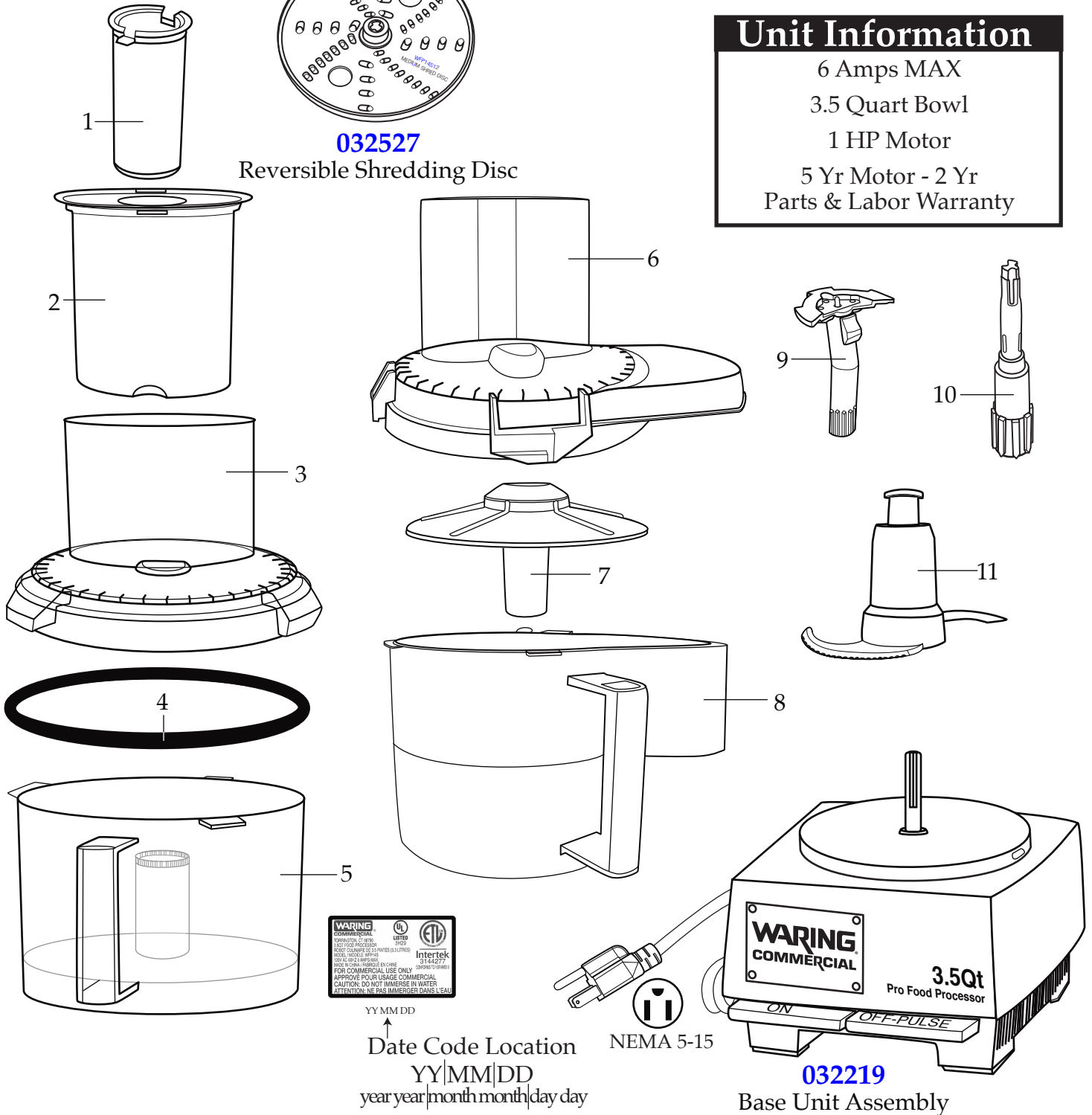

YY MM DD
↑
Date Code Location
YY|MM|DD
year|year|month|month|day|day



032219
Base Unit Assembly

Catalog/Model

WFP14S
WFP14SC

WARING COMMERCIAL

314 Ella T. Grasso Ave.
Torrington, CT 06790
Tele. 1-800-269-6640
Fax 860-496-9017

www.waringcommercialproducts.com

Illustration #	Part #	Description
1	032221	Small Pusher
2	032220	Large Pusher
3	032222	Bowl Cover
4	030562	Cover Seal
5	030563	Bowl
6	032223	Continuous Feed Cover
7	030566	Slinger
8	030565	Continuous Feed Bowl
9	030567	Disc Stem
10	032521	Adjustable Disc Stem
11	030568	Serrated S Blade

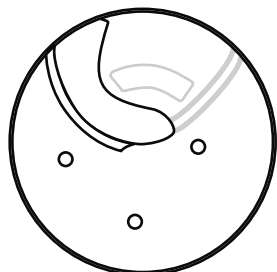

Slicing Disc

032238

5/64" (2mm)

032216

5/32" (4mm)

032529

1/4" (6mm)

032530

5/16" (8mm)

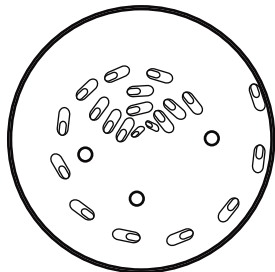

Shredding Disc

032217

5/32" (4mm)

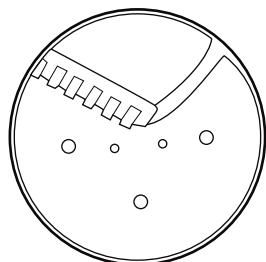

French-Fry Disc

032531

1/4" x 1/4" (6 x 6mm)

Internal Components

