

Unit Information

60Hz - 1440 Watts - 120 Volts
Temperature range from 150°F - 205°F
(66°C - 96°C)
Fold down shelf for small cups

WARING COMMERCIAL

5 Gallon Hot Water Dispenser WWB5G

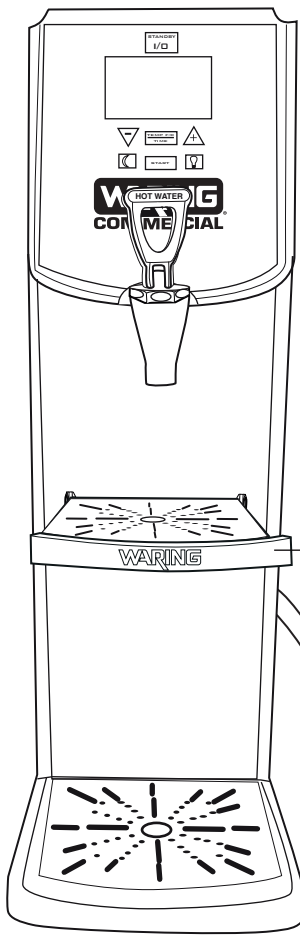

037735
WWB5G Unit

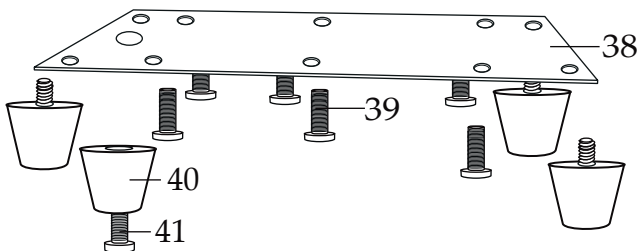
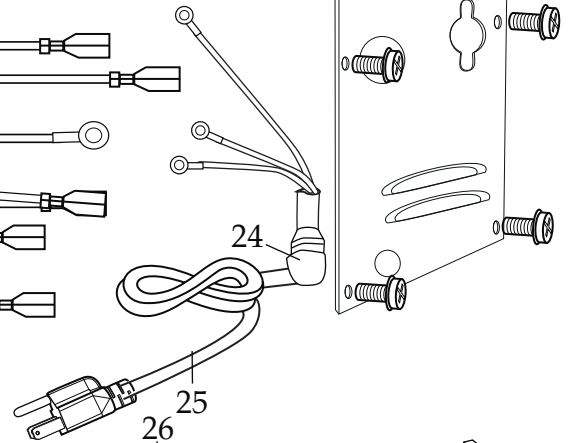
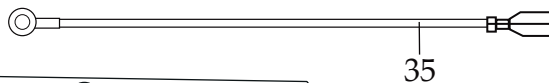
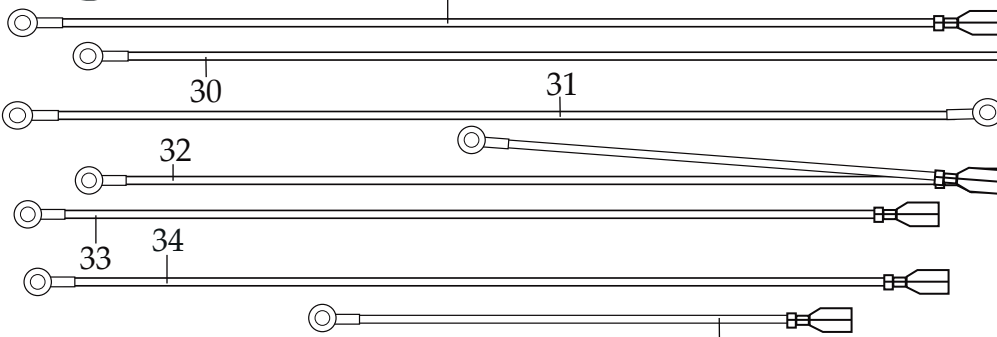
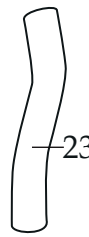
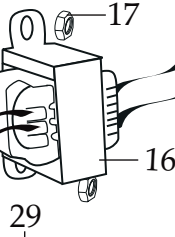
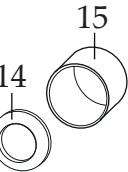
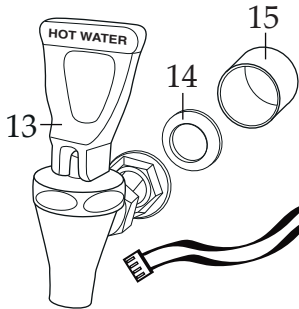
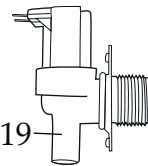
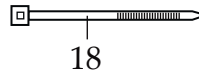
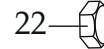
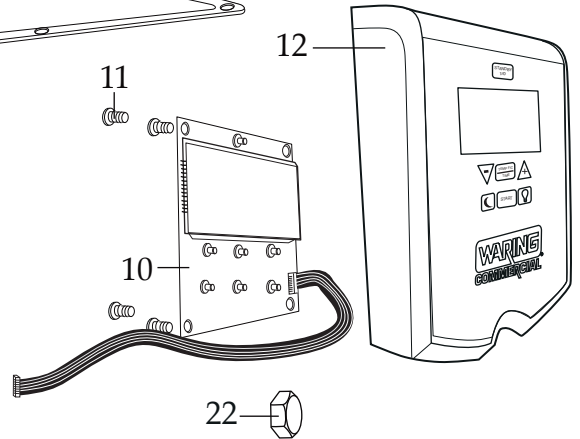
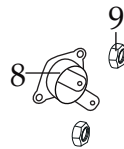
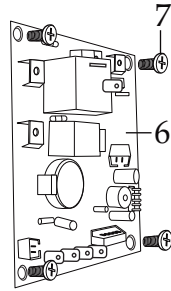
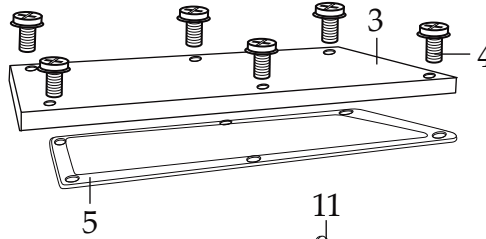
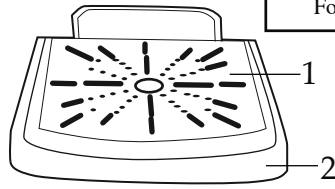

Illustration#	Part#	Description
1	037696	Overflow Tray (metal)
2	037697	Overflow Tray (plastic)
3	037698	Tank Top Cover
4	037717	Screw (6 required)
5	037699	Tank Top Cover Gasket
6	037704	PCB Board
7	037163	Screw (4 required)
8	037153	Thermal Cut Off
9	037154	Hex Nut (2 required)
10	037700	Control Board
11	037701	Screw (4 required)
12	037702	Control Panel
13	037149	Tap (spigot)
14	037728	Tap Seal
15	037703	Tap Ring
16	037708	Transformer
17	037709	Hex Nut (2 required)
18	013731	Wire Ties (5 required)
19	037165	Solenoid Valve
20	037717	Screw (2 required)
21	037705	Yellow Valve Cover
22	037707	Pipe Cover
23	037771	Valve Tube
24	037172	Strain Relief
25	037173	Cord Set (NEMA 5-15P)
26	037715	Heating Element
27	037169	Element Seal (2 required)
28	037170	Element Hex Nut (2 required)
29	037731	16.5" Black Lead (2 required 1 ring and 1 regular terminal)
30	037733	16.5" Burgundy Lead (1 ring and 1 regular terminal)
31	037732	16 .5" Burgundy Lead (2 ring terminals)
32	037730	Double Blue Lead (2 ring and 1 regular terminal)
33	037729	16.75" Yellow / Green Lead (1 ring and 1 regular terminal)
34	037710	12.5" Black Lead (1 ring and 1 regular terminal)

PCB Board

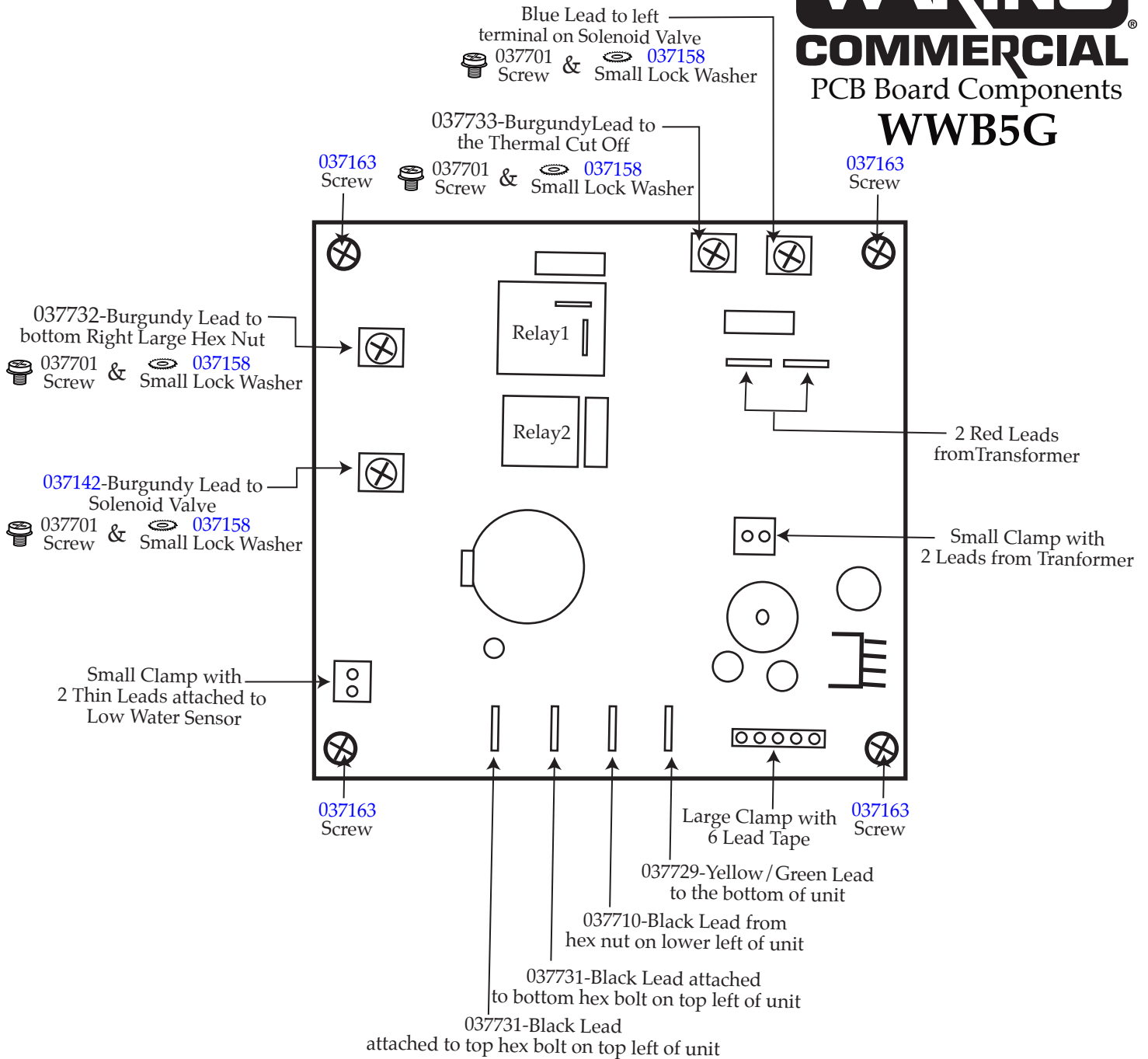

Illustration#	Part#	Description
35	037142	8.75" Burgundy Lead (1 ring and 1 regular terminal)
36	037734	Back Plate
37	037717	Screw (8 required)
38	037718	Bottom Plate
39	037719	Screw (6 required)
40	037720	Rubber Feet (4 required)
41	037721	Feet Screw (4 required)
42	037772	Small Overflow Tray (plastic)