



WELLS BLOOMFIELD, LLC
10 Sunnen Dr., St. Louis, MO 63143
telephone: 314-678-6314
fax: 314-781-2714
www.wellsbloomfield.com

011B

OWNERS MANUAL

**BUILT-IN
BOTTOM-MOUNT
AUTOFILL
WARMER**

**MODELS
BMW206ULRTD/AF
BMW206ULSTD/AF**



BMW206ULRTD/AF

**Includes
INSTALLATION
USE & CARE
EXPLODED VIEW
PARTS LIST
WIRING DIAGRAM**

IMPORTANT: DO NOT DISCARD THIS MANUAL

This manual is considered to be part of the appliance and is to be given to the OWNER or MANAGER of the restaurant, or to the person responsible for TRAINING OPERATORS of this appliance. Additional manuals are available from your WELLS DEALER.

THIS MANUAL MUST BE READ AND UNDERSTOOD BY ALL PERSONS USING OR INSTALLING THIS APPLIANCE. Contact your WELLS DEALER if you have any questions concerning installation, operation or maintenance of this equipment.

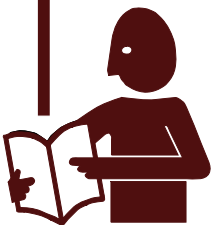

LIMITED WARRANTY STATEMENT

Unless otherwise specified, all commercial cooking equipment manufactured by WELLS BLOOMFIELD, LLC is warranted against defects in materials and workmanship for a period of one year from the date of original installation or 18 months from the date of shipment from our factory, whichever comes first, and is for the benefit of the original purchaser only.

THIS WARRANTY IS THE COMPLETE AND ONLY WARRANTY, EXPRESSED OR IMPLIED IN LAW OR IN FACT, INCLUDING BUT NOT LIMITED TO, WARRANTIES OF MERCHANTABILITY OR FITNESS FOR ANY PARTICULAR PURPOSE, AND/OR FOR DIRECT, INDIRECT OR CONSEQUENTIAL DAMAGES IN CONNECTION WITH WELLS BLOOMFIELD PRODUCTS.

This warranty is void if it is determined that, upon inspection by an authorized service agency, the equipment has been modified, misused, misapplied, improperly installed, or damaged in transit or by fire, flood or act of God. It also does not apply if the serial nameplate has been removed, or if service is performed by unauthorized personnel.

The prices charged by Wells Bloomfield for its products are based upon the limitations in this warranty. Seller's obligation under this warranty is limited to the repair of defects without charge by a Wells Bloomfield factory authorized service agency or one of its sub-service agencies. This service will be provided on customer's premises for non-portable models. Portable models (a device with a cord and plug) must be taken or shipped to the closest authorized service agency, transportation charges prepaid, for service. In addition to restrictions contained in this warranty, specific limitations are shown in the Service Policy and Procedure Guide. Wells Bloomfield authorized service agencies are located in principal cities. This warranty is valid in the United States and Canada and void elsewhere. Please consult your classified telephone directory, your foodservice equipment dealer or contact:

Wells Bloomfield, LLC

10 Sunnen Dr., St. Louis MO 63143 USA

phone (314) 678-6314 or fax (314) 781-2714

for information and other details concerning warranty.

SERVICE POLICY AND PROCEDURE GUIDE and ADDITIONAL WARRANTY EXCLUSIONS

1. Resetting of safety thermostats, circuit breakers, over load protectors, and/or fuse replacements are not covered by this warranty unless warranted conditions are the cause.
2. All problems due to operation at voltages or phase other than specified on equipment nameplates are not covered by this warranty. Conversion to correct voltage and/or phase must be the customer's responsibility.
3. All problems due to electrical connections not made in accordance with electrical code requirements and wiring diagrams supplied with the equipment are not covered by this warranty.
4. Replacement of items subject to normal wear, to include such items as knobs, light bulbs; and, normal maintenance functions including adjustments of thermostats, adjustment of micro switches and replacement of fuses and indicating lights are not covered by warranty.
5. Damage to electrical cords and/or plug due to exposure to excessive heat are not covered by this warranty.
6. Full use, care, and maintenance instructions supplied with each machine. Noted maintenance and preventative maintenance items, such as servicing and cleaning schedules, are customer responsibility. Those miscellaneous adjustments noted are customer responsibility. Proper attention to preventative maintenance and scheduled maintenance procedures will prolong the life of the appliance.
7. Travel mileage is limited to sixty (60) miles from an Authorized Service Agency or one of its sub-service agencies.
8. All labor shall be performed during regular working hours. Overtime premium will be charged to the buyer.
9. All genuine Wells replacement parts are warranted for ninety (90) days from date of purchase on non-warranty equipment. This parts warranty is limited only to replacement of the defective part(s). Any use of non-genuine Wells parts completely voids any warranty.
10. Installation, labor, and job check-outs are not considered warranty and are thus not covered by this warranty.
11. Charges incurred by delays, waiting time or operating restrictions that hinder the service technician's ability to perform service are not covered by warranty. This includes institutional and correctional facilities.

SHIPPING DAMAGE CLAIM PROCEDURE

NOTE: For your protection, please note that equipment in this shipment was carefully inspected and packaged by skilled personnel before leaving the factory. Upon acceptance of this shipment, the transportation company assumes full responsibility for its safe delivery.

IF SHIPMENT ARRIVES DAMAGED:

1. **VISIBLE LOSS OR DAMAGE:** Be certain that any visible loss or damage is noted on the freight bill or express receipt, and that the note of loss or damage is signed by the delivery person.
2. **FILE CLAIM FOR DAMAGE IMMEDIATELY:** Regardless of the extent of the damage.

3. **CONCEALED LOSS OR DAMAGE:** if damage is unnoticed until the merchandise is unpacked, notify the transportation company or carrier immediately, and file "CONCEALED DAMAGE" claim with them. This should be done within fifteen (15) days from the date the delivery was made to you. Be sure to retain the container for inspection.

Wells Bloomfield cannot assume liability for damage or loss incurred in transit. We will, however, at your request, supply you with the necessary documents to support your claim.

TABLE OF CONTENTS

WARRANTY	xi
FEATURES & OPERATING CONTROLS	2
PRECAUTIONS & GENERAL INFORMATION	3
AGENCY LISTING INFORMATION	3
INSTALLATION	4
OPERATION	6
MAINTENANCE INSTRUCTIONS	7
CLEANING INSTRUCTIONS	8
TROUBLESHOOTING SUGGESTIONS	10
EXPLODED VIEW & PARTS LIST	11
WIRING DIAGRAM	12
PARTS & SERVICE	13
CUSTOMER SERVICE DATA	13

INTRODUCTION

Thank You for purchasing this Wells Bloomfield appliance.

Proper installation, professional operation and consistent maintenance of this appliance will ensure that it gives you the very best performance and a long, economical service life.

This manual contains the information needed to properly install this appliance, and to use and care for the appliance in a manner which will ensure its optimum performance.

SPECIFICATIONS

MODEL	VOLTS	AMPS	WATTS	POWER SUPPLY CORD
BMW206RTDU/AFU BMW206STDU/AFU	120 VAC 1Ø	10.0A	1200W	NOT SUPPLIED
	208 VAC 1Ø	6.0A	1240W	
	240 VAC 1Ø	6.9A	1650W	

FEATURES & OPERATING CONTROLS

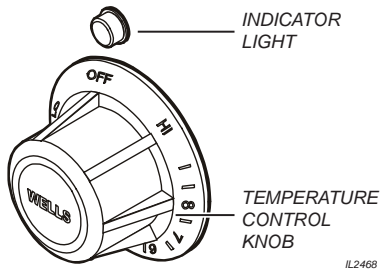

A. THERMOSTAT

1. On thermostatically controlled warmers, power is applied to the heating element according to the control knob position and the actual temperature at the temperature sensing thermobulb.
2. The desired temperature is controlled by rotating the temperature control knob. The knob has a numeric scale, where higher numbers correspond to higher temperature.
3. On warmers equipped with an indicator light, the light will glow when the thermostat is calling for heat (i.e. the element is energized).
4. The TEMPERATURE CONTROL KNOB will rotate approximately 300°, and will reach a “stop” at both ends. The OFF position is marked.

NOTE: The dial position is an indication of the temperature setting. Actual temperature will vary depending upon the type of product and food consistency.

B. MOUNTING

1. Bottom-mounted warmers require that the cutout be flanged to provide a mounting means.
2. See the Installation Instructions, supplied with the particular appliance, for details.

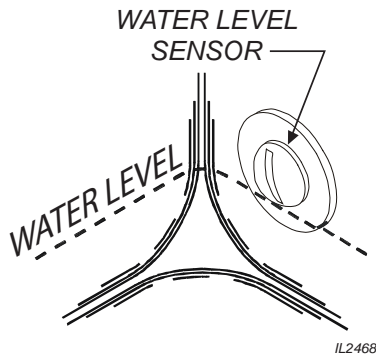

C. DRAINS

1. Suffix “D” units (e.g. BMW206ULRTD/AF) have drains for each pan, with each pan having an individual drain valve.

D. AUTOFILL

1. On AUTOFILL BMW units, water level is automatically fed into the pan whenever the thermostat is ON .
2. Water level is sensed by a WATER LEVEL PROBE in the pan.

PRECAUTIONS AND GENERAL INFORMATION

This appliance is intended for use in commercial establishments only.

This appliance is intended to hold pre-heated food for human consumption. No other use is recommended or authorized by the manufacturer or its agents.

Operators of this appliance must be familiar with the appliance use, limitations and associated restrictions. Operating instructions must be read and understood by all persons using or installing this appliance.

Cleanliness of this appliance is essential to good sanitation. Read and follow all included cleaning instructions and schedules to ensure the safety of the food product.

Disconnect this appliance from electrical power before performing any maintenance or servicing.

This appliance is not jet stream approved. Do not direct water jet or steam jet at this appliance, or at any control panel or wiring. Do not splash or pour water on, in or over any controls, control panel or wiring.

Exposed surfaces of this appliance can be hot to the touch and may cause burns.

Do not operate this appliance if the control panel is damaged. Call your Authorized Wells Service Agent for service.

The technical content of this manual, including any wiring diagrams, schematics, parts breakdown illustrations and/or adjustment procedures, is intended for use by qualified technical personnel.

Any procedure which requires the use of tools must be performed by a qualified technician.

This manual is considered to be a permanent part of the appliance. This manual and all supplied instructions, diagrams, schematics, parts breakdown illustrations, notices and labels must remain with the appliance if it is sold or moved to another location.

This appliance is made in the USA. Unless otherwise noted, this appliance has American sizes on all hardware.



WARNING: SHOCK HAZARD

All servicing requiring access to non-insulated electrical components must be performed by a factory authorized technician.

DO NOT open any access panel which requires the use of tools. Failure to follow this warning can result in severe electrical shock.



CAUTION: RISK OF DAMAGE

DO NOT connect or energize this appliance until all installation instructions are read and followed. Damage to the appliance may result if these instructions are not followed.



CAUTION: HOT SURFACE

Exposed surfaces can be hot to the touch and may cause burns.

AGENCY LISTING INFORMATION

Refer to the product nameplate for the specific appliance for agency listings. In general:

This appliance conforms to NSF Standard 4 for sanitation only if installed in accordance with the supplied Installation Instructions.

UL Listed warmers are U Listed under UL File E6070.



STD 4



E6070

UL Listed Warmers

INSTALLATION

NOTE: DO NOT discard the carton or other packing materials until you have inspected the appliance for hidden damage and tested it for proper operation. Refer to *SHIPPING DAMAGE CLAIM PROCEDURE* on the inside front cover of this manual.



WARNING: RISK OF INJURY

Installation procedures must be performed by a qualified technician with full knowledge of all applicable electrical and plumbing codes. Failure can result in personal injury and property damage.



CAUTION FIRE HAZARD

Avoid storing flammable or combustible materials in, on or near the appliance.

IMPORTANT: For warmers installed in plastic counter tops, the counter material must be protected from the heat of the warmer in order to prevent discoloration and/or deterioration. Wellsloks are not suitable for this purpose. The installer should contact the manufacturer or distributor of the countertop material for specific instructions.

Wells Bloomfield does not recommend bottom-mounted warmers be mounted in plastic counters.

UNPACKING & INSPECTION

Carefully remove the appliance from the carton. Remove all protective plastic film, packing materials and accessories from the Appliance before connecting electrical power or otherwise performing any installation procedure.

Carefully read all instructions in this manual and the Installation Instruction Sheet packed with the appliance before starting any installation.

Read and understand all labels and diagrams attached to the appliance.

Carefully account for all components and accessories before discarding packing materials. Store all accessories in a convenient place for later use.

INSTALLATION NOTES

1. Installation and start up of built-in warmers **MUST** be performed by an authorized installation company.
2. It is the responsibility of the installer to verify that this warmer installation is in compliance with the specifications listed in this manual and on the specification sheet provided.
3. It is the **RESPONSIBILITY OF THE INSTALLER** to check with the authority having jurisdiction, in order to verify that this warmer installation is in compliance with local code requirements.
4. Water supply and drain installation must meet all applicable local, state and federal plumbing codes and ordinances.
5. Refer to Installation Instructions included with the warmer for Underwriters Laboratories conditions of acceptability, electrical requirements and other installation concerns.

BUILT-IN WARMERS

1. This is a **GENERAL GUIDE**. For specific cutout dimensions and other installation details, refer to the Installation Instructions supplied with the warmer.
2. Cutout dimensions for warmer units and control panels are listed on the Installation Instructions provided with the warmer.
3. Bottom-mounted warmers require that a flange be formed in the edge of the cutout as a means of mounting the warmer to the counter. Verify style of unit (e.g square-corner, radiused-corner) before making cutout.

NOTE: Cutout dimensions are different for square-corner and radiused-corner units. Verify the dimensions are correct for the installation before making the cutout.

4. For “bottom-mounted” warmers (i.e. warmers mounted to a formed flange from underneath the counter top), apply a bead of food-grade silicone sealant to the top inside lip of the pan prior to attaching to the counter flange.

INSTALLATION

ELECTRICAL INSTALLATION

1. Refer to the product nameplate. Verify the electrical service power. Voltage and phase must match the nameplate specifications. Wiring the warmer to the wrong voltage can severely damage the unit or cause noticeably decreased performance.
2. Available electrical service amperage must meet or exceed the specifications listed on the specification sheet provided with the warmer.
3. Warmer and control unit must be connected to an appropriate building ground. Ground connection will be marked "GND" or "⏏".

NOTE: Wire gauge, insulation type and temperature rating, as well as type, size and construction of conduit, must meet or exceed applicable specifications of local codes and of the National Electrical Code.

PLUMBING INSTALLATION

For use in the State of Massachusetts, this appliance must be installed in compliance with **Massachusetts Fuel Gas and Plumbing Code CMR 248**.

1. **IMPORTANT:** All plumbing installations must be performed by a qualified plumber.
2. For units equipped with a DRAIN LINE: Some jurisdictions may require an approved air gap or other back-flow prevention device in the drain. It is the responsibility of the plumber to determine such requirement, to provide and properly install the required device.
3. For AUTOFILL units: Some jurisdictions may require an approved back-flow preventer in the water supply line. It is the responsibility of the plumber to determine such requirement, and to provide and properly install the required device.
Autofill supply must be connected to a COLD WATER line only.

NOTE: Damage caused by leaks due to improper installation is NOT covered by warranty.



CAUTION: SHOCK HAZARD

The ground lug of this appliance must be connected to a suitable building ground.

IMPORTANT:

Contact a licensed electrician to install and connect electrical power to the appliance.

IMPORTANT:

Damage due to being connected to the wrong voltage or phase is NOT covered by warranty.

IMPORTANT: Electrical installation other than as specified on the specification sheet will void the UL listing, and may void the warranty.

NOTE: Plumb connections must be made in compliance with all Federal, State and Local Plumbing Codes and Ordinances.

OPERATION



CAUTION: HOT SURFACE

Exposed surfaces can be hot to the touch and may cause burns.



CAUTION: SHOCK HAZARD

DO NOT splash or pour water onto control panel or wiring.

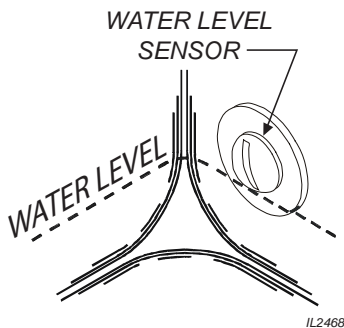

IMPORTANT: DO NOT use autofill warmers in the dry mode. This may damage the water level sensor.

Always use an inset.

DO NOT place food directly into the warmer.

DO NOT put ice into a warmer pan. This will cause condensation on the inside of the warmer. Damage caused by condensation is **NOT** covered by warranty.

Stir thick food items frequently to keep food heated uniformly.

Keep insets covered to maintain food quality and temperature.

AUTOFILL WARMERS

1. Autofill warmers sense water level by a sensor placed at the proper level. For manifolded autofill warmers, the water level sensor / fill tube is in one pan only, normally in the far left pan.
2. Water fills the pan through an inlet tube. For manifolded autofill warmers, the fill tube is normally in the far left pan. All other sections fill at the same time through the drain manifold.
3. The autofill function is active only when the thermostat for the pan with the water level sensor is turned ON.
4. Make sure the drain valve is fully closed before turning any thermostats ON.
5. The autofill function is only activated when the far left thermostat is turned ON. For manifolded autofill warmers, be sure to turn far left thermostats ON before turning any other control ON, to avoid heating a dry pan.
6. **DO NOT** use autofill warmers in the dry mode. This may damage the water level sensor probe. NEVER turn the thermostat ON for the pan with the probe and fill tube unless the entire warmer unit is to be used in the wet mode.
7. Clean water level sensor daily to maintain water level in warmer.

PRE-HEATING THE WARMER

1. Place desired pan(s) or inset(s) with appropriate adapter top on warmer.
 - a. Insets are available as accessories in 2½ qt., 4qt., 7 qt., and 11 qt. sizes with lids and adapter tops.
 - b. For dry operation, a 6" deep pan or inset is recommended.
2. Turn temperature control to HI or highest temperature setting.
3. Allow warmer to preheat for approximately 30 minutes, then set the control for the desired temperature. Be sure to keep the warmer covered during preheat and operation.

OPERATION

1. Always use an inset. **DO NOT** place food directly into the warmer.
2. **DO NOT** use metal tools, steel wool, or caustic or abrasive cleanser to clean warmer pan.

MAINTENANCE INSTRUCTIONS

CARE OF STAINLESS STEEL

Stainless steel is a marvelous material: strong, lustrous and low maintenance. With a minimum of care, it will normally retain its beauty and durability for the life of the equipment. In some applications, however, special care is required in order to maintain stainless steel's special properties.

External components, such as cabinets and control panels, are finished with a grain pattern. This pleasing finish is best maintained by cleaning with a non-abrasive cleanser applied with a soft cloth. Rub only in the direction of the grain. In the absence of visible grain, rub only along the longest axis of the appliance.

Restore stainless steel's luster by applying a polish specifically made for stainless steel. Spray on, wipe off with a soft cloth, rubbing in the direction of the grain.

Never use metal implements, wire brushes, abrasive scratch pads or steel wool to clean stainless steel.

Warmer pans, insets and other vessels are subject to a harsher environment. Wells Manufacturing uses an very high quality stainless steel (#304DDQ) for our food warmer pans. Even the highest quality stainless steel, however, is mostly iron, and will rust, pit and corrode under the following conditions:

- **Poor Water Quality:** Hard water (water with a high content of dissolved minerals) will leave mineral deposits when allowed to dry. Calcium (lime) can buildup on heated surfaces, even under water. If left unattended, hard water spots and lime buildup can lead to rusting, corrosion and pitting.
- **Contact with Chlorides:** Chlorides (specific compounds of chlorine) are found in food, table salt and many cleansers. Chlorides can attack the surface of stainless steel, resulting in corrosion and pitting.

Keep your stainless steel warmers clean and free from calcium buildup.

Use alkaline, alkaline chlorinated or non-chloride cleanser.

Use citric acid-based cleaners to remove calcium deposits.

For additional information, please read the NAFEM Stainless Steel Equipment and Cleaning Guide. Contact NAFEM at :

North American Association of Food Equipment Manufacturers

401 N. Michigan Avenue

Chicago, Illinois 60611-4267

(312) 644-6610

CLEANING INSTRUCTIONS



CAUTION: SHOCK HAZARD

Do NOT splash or pour water into or over any control panel or wiring.



CAUTION: SHOCK HAZARD

Disconnect warmer from electric power before cleaning



CAUTION: BURN HAZARD

Allow warmer to cool completely before cleaning.

DAILY CLEANING INSTRUCTIONS

PREPARATIONS: Turn control knob(s) to OFF. Allow warmer to cool before proceeding.
Remove any insets, pans and/or adapter tops.
Drain or remove water from well if used for wet operation.

FREQUENCY: Minimum - daily.

TOOLS: Mild Detergent
Solution: 10 Parts Warm Water to 4 Parts Vinegar
Plastic Scouring Pad
Clean Cloth or Sponge
Food-Grade Silicone Sealant

1. Wipe entire unit down using a clean cloth or sponge and mild detergent. Carefully wipe any debris and residue from the water level sensor.
2. Use a plastic scouring pad to remove any hardened food particles or mineral deposits. **IMPORTANT:** Do NOT use steel wool for cleaning.
3. Rinse warmer thoroughly with a vinegar and water solution to neutralize all detergent cleanser residue.
4. Inspect warmer flange-to-counter seal. Reseal with food-grade silicone sealant if necessary. Failure to do so may allow grease and water to leak into insulation and heating element, causing a potential fire and/or electric shock hazard.
5. Inspect warmer tank for damage. Damage to the outer body may allow grease and water to leak into insulation and heating element, causing a potential fire and/or electric shock hazard. Contact your Authorized Wells Service Agency to inspect warmer if water or grease contamination is suspected.
6. Close drain valve. Add proper amount of warm water. Turn control knob(s) ON and check for proper operation.

CLEANING INSTRUCTIONS

WEEKLY CLEANING INSTRUCTIONS

PREPARATIONS: Remove any insets, pans and/or adapter tops. Drain or remove water from well if used for wet operation.

FREQUENCY: Weekly, or whenever lime or scale is seen accumulating on the sides of the warmer pans.

TOOLS:
Commercial Delime Cleaner
Plastic Scouring Pad
Clean Cloth or Sponge



CAUTION: CHEMICAL BURN HAZARD

Deilimng chemicals may be caustic. Wear appropriate personal protective equipment. Follow cleaner manufacturer's instructions for safest use.

1. Add water to pans until water is at normal operating level (1" - 1 1/2" deep) or covers accumulated scale.
2. Heat water to maximum temperature (190°F or higher).
3. Pour contents of one package of commercial delime cleaner into each warmer pan. Stir to dissolve cleaner. Turn heat control OFF. Cover pans.
4. Allow solution to soak at least one hour, or overnight for heavy scale buildup.
5. Drain hot water from pans. Scrub with a plastic scouring pad. Rinse thoroughly with hot water, then dry.
6. Refill pans with hot tap water and resume operation.
7. Heavy scale buildup may require additional treatments.

TROUBLESHOOTING SUGGESTIONS

SYMPTOM	POSSIBLE CAUSE	SUGGESTED REMEDY
No power to warmer	Circuit breaker off or tripped	Reset circuit breaker
Warmer will not heat	Temperature control not set	Set control to desired temperature
Warmer trips circuit breaker	Wet insulation	Verify flange-to counter seal is sound, or reseal with food-grade silicone sealant
	Pan leaking or other internal damage	Contact your Authorized Wells Service Agency for repairs
	Internal damage	Contact your Authorized Wells Service Agency for repairs
Warmer slow to heat	Mineral deposits on pan acting as an insulator	Clean pan(s) with delime cleaner
	Wired to wrong voltage	Verify supply voltage - must match voltage on warmer nameplate
Drain-equipped unit will not hold water	Drain valve not fully closed	Check drain valve for debris and close fully
	Drain valve damaged or pan(s) leaking	Contact your Authorized Wells Service Agency for repairs
Auto-fill unit overflows	Water level sensor dirty	Clean water level sensor
	Internal damage	Contact your Authorized Wells Service Agency for repairs
Auto-fill unit does not fill	Water supply turned off or restricted	Be sure water supply is turned on and water supply hose is not pinched or twisted
	Bad Probe or other Internal Damage	Contact your Authorized Wells Service Agency for repairs
One or more pans of an auto-fill unit do not fill	Blocked drain manifold	Clean drain manifold

There are no user-serviceable components in this appliance.
 In all instances of damage or malfunction, contact your Authorized Wells Service Agency for repairs.

EXPLODED VIEW & PARTS LIST

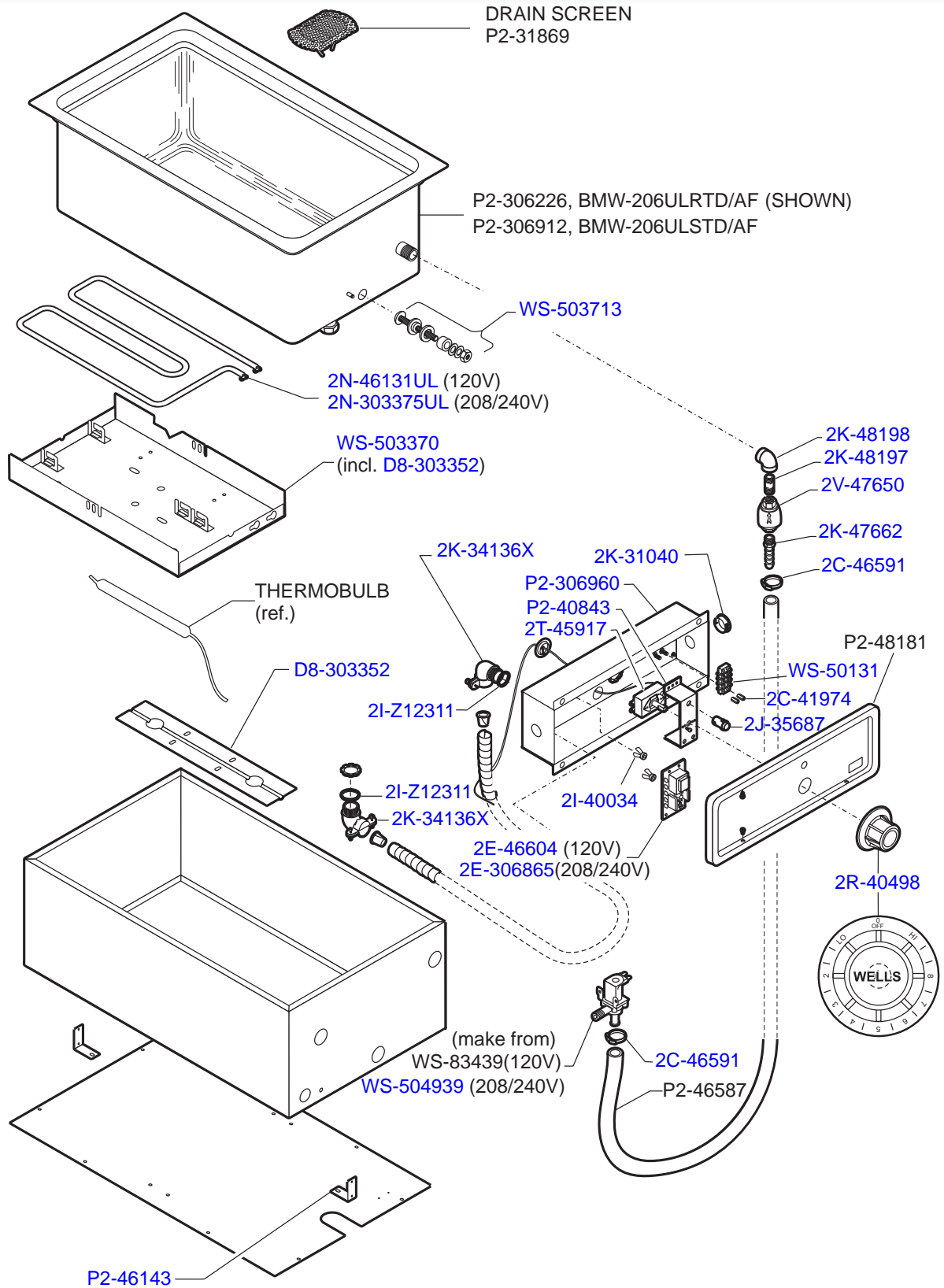

M011B.02 2M-308015 Owners Manual for Bottom-Mount Autofill Warmers

Model: BMW206RTDU/AFU, STD/AF

IL2471-011B, Rev. A, 9/20/12

WIRING DIAGRAM

WIRING DIAGRAM FOR MOD 100TD-BMW206 WARMER W/AF
120 AND 208/240V, SINGLE PHASE

MODEL	VOLTS	WATTS	SINGLE PHASE
MOD100TD	208	1240	6.0
BMW206UL	240	1650	6.9
MOD100TD	208	1650	7.9
BMW206UL	120	1200	10.0

50 / 60 HZ

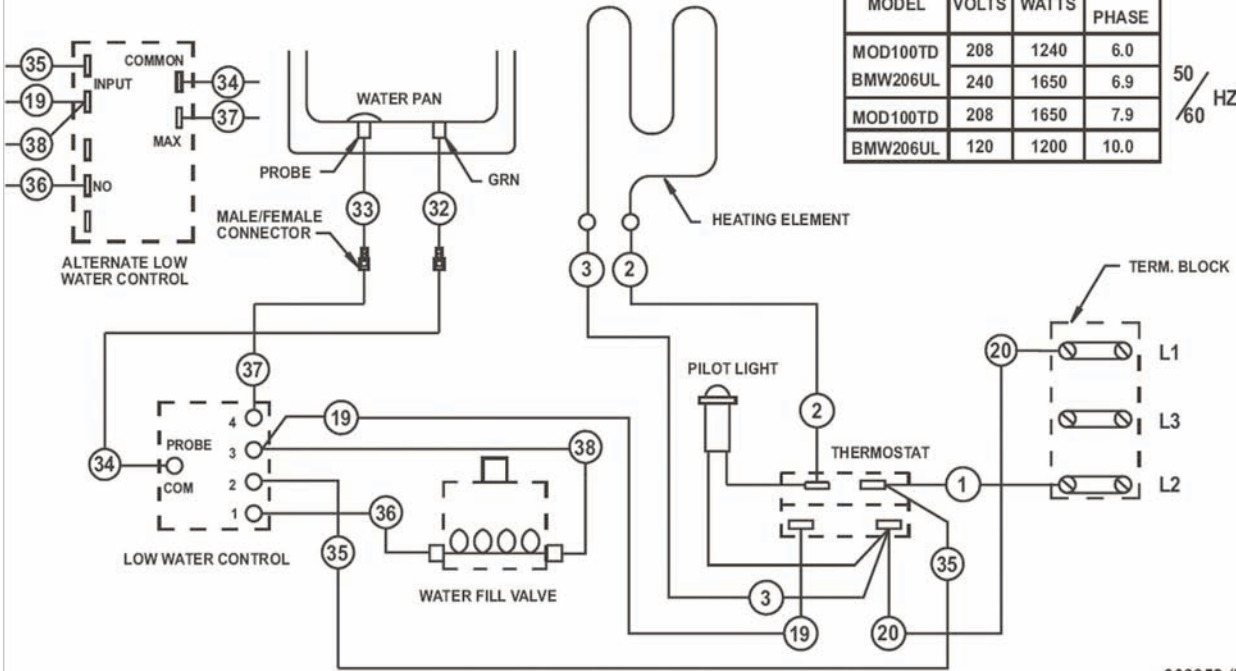

306952 (B)

PARTS & SERVICE

DESCRIPTION	PART NO.	IMPORTANT: Use only factory authorized service parts and replacement filters.
ACCESSORIES		
4 QT. ROUND INSET w/ lid	WS-20774	For factory authorized service, or to order factory authorized replacement parts, contact your Wells authorized service agency, or call:
7 QT. ROUND INSET w/ lid	WS-20587	
11 QT. ROUND INSET w/ lid	WS-20908	
11 QT. ROUND INSET w/ hinged lid	5D-21057	Wells Bloomfield, LLC 10 Sunnen Dr., St. Louis MO 63143 USA
DRAIN VALVE EXTENSION KIT, extension from drain to counter front with remote handle, for use with "D" models only, excluding "DM" models	WS-20385	Service Dept. phone: (314) 678-6314 fax: (314) 781-2714
DRAIN SCREEN	P2-31869	Service Parts Department can supply you with the name and telephone number of the WELLS AUTHORIZED SERVICE AGENCY nearest you.
OPTIONAL 72" WIRING, thermostatically controlled warmers ** ** contact factory customer service for availability		

CUSTOMER SERVICE DATA

please have this information available if calling for service

RESTAURANT _____	LOCATION _____
INSTALLATION DATE _____	TECHNICIAN _____
SERVICE COMPANY _____	
ADDRESS _____	STATE _____ ZIP _____
TELEPHONE NUMBER (____)____-_____	
EQUIPMENT MODEL NO. _____	
EQUIPMENT SERIAL NO. _____	
VOLTAGE: (check one) 120 <input type="checkbox"/> 208 <input type="checkbox"/> 240 <input type="checkbox"/>	



Wells Bloomfield proudly supports CFESA
Commercial Food Equipment Service Association

SERVICE TRAINING - QUALITY SERVICE



CUSTOMER SATISFACTION



WELLS BLOOMFIELD, LLC
10 Sunnen Dr., St. Louis, MO 63143
telephone: 314-678-6314
fax: 314-781-2714
www.wellsbloomfield.com