

Series Includes:

- PF46
- PF56
- LP46
- LP56
- OF49
- OF59



WELCOME

If you have questions about your Collectramatic equipment, please contact your corporate office, local distributor, or Winston’s Customer Care Center at 1.800.234.5286 or 1.502.495.5400, or e-mail us at customercare@winstonind.com.

CONTACT INFORMATION:

Web: www.winstonfoodservice.com
 E-mail: customercare@winstonind.com
 Phone: 1.800.234.5286 | 1.502.495.5400
 Fax: 1.502.495.5458
 Mail: 2345 Carton Drive | Louisville, KY 40299 USA

CONTENTS

Safety2-4
 Component Identification - Pressure Fryer5-6
 Component Identification - Open Fryer7-8
 Accessories9
 Assembly of Fryers..... 10
 Operating Instructions 11-15
 Daily Care 15-17
 Controls - 8000 Series 18
 Programming..... 19-27
 Aqualert® Software 28
 Warranty and Terms & Conditions 29

SAFETY

As is the case with most cooking equipment, your Collectramatic fryer should be used with caution. Please read the following warnings to avoid potential injuries.

 DANGER: Electrical Hazard

Can cause serious injury or death >> Do not attempt to service this equipment unless you are a licensed electrician or trained servicer.

Because this equipment utilizes high voltage, it should only be installed and serviced by a licensed electrician or trained servicer. Attempting to install or service the equipment yourself could result in serious, potentially fatal injuries.

If an electrical shock is felt when touching equipment, shut off power immediately (pull cord or turn off circuit breaker) and call a trained servicer for repair. Failure to do so could result in serious, potentially fatal injuries. Always turn power switch off any time equipment is not in use.

Copyright© 2020 Winston Foodservice. All rights reserved. Collectramatic is a registered trademark of Winston Industries LLC. The Collectramatic logo is a trademark of Winston Industries LLC. All other company and product names may be trademarks of their respective companies.

 WARNING: Burn Hazard

Can cause serious injury >> High Temperatures | High Voltage | Hot Cooking Oil Under Pressure

To avoid painful, scarring, life-threatening injuries, emotional disorders, or property damage, read and obey this sheet, all DANGER labels, the Owner’s Manual, and information supplied with service parts before using, cleaning, or working on this fryer.

1. **ALWAYS** check to make sure you can read all DANGER labels. Take fryer out of service immediately until all unreadable labels are replaced. Contact Winston Customer Care at 1.800.234.5286 for replacement labels.
2. **INSPECT** fryer for faulty, loose, or missing parts. If faulty, loose, or missing parts are discovered, take fryer out of service and do not operate fryer until it is repaired.
3. **USE** fryer only with Winston-approved controls.
4. **DO NOT** mix parts between Collectramatic fryer models.
5. **DO NOT** operate fryer if you feel an electrical shock. Take fryer out of service until it is repaired.
6. **DO NOT** open panels or attempt repairs if you are not a trained servicer.
7. **DO NOT** use fryer unless it is secured to prevent tip-over.
8. **DO NOT** use fryer until floor around fryer is in a clean, non-slip condition.
9. **DO NOT** stand, sit, or lean on fryer.
10. **DO NOT** place any objects, other than fryer accessories, near fryer.
11. **DO NOT** over-fill or under-fill fryer with cooking oil. Adjust hot cooking oil (at cooking temperature) so that the oil level is between the **MAXIMUM** and **MINIMUM** lines.

12. HOT LIQUIDS UNDER PRESSURE

To safely close lid:

- A. Use both hands on handlebar to lower lid.
- B. Pull handlebar completely into lid lock block so that lid lock pops up ("clank" sound) into its straight, locked position.

To safely open lid:

- A. Wait until cook cycle is finished (timer at 00:00 and buzzer sounds).
- B. Do not touch handlebar to open lid until pressing down on lid lock causes the lid to lower.
- C. Then with the lid in the lowered position, use one hand to move handlebar to open.

13. **DO NOT** open drain valve until fryer power is OFF and lid is open. Use safety gloves and place an appropriate container or filter in position under drain valve before opening valve.

14. **DO NOT** install or attach any piping or tubing to drain valve other than Winston drain valve extension.

15. **DO NOT** handle fryer basket without using safety gloves and basket hook or lift assist tool.

16. **DO NOT** stir cooking oil in collector after the first round of cooking each day. Cooking oil may come up and out of cookpot.

17. **DO NOT** clean or move fryer until you have disconnected fryer from power, completely removed lid, drained cooking oil, and removed collector. Never use "boil-out" method or water for cleaning fryer cookpot.

18. **DO NOT** splash water or use hose on outside of fryer. Use only damp towel to clean fryer surfaces outside of cookpot.

19. **DO NOT** use any liquids other than cooking oils in fryer cookpot.

20. **PURCHASE** only Winston authorized replacement parts, which will provide the most current danger warnings.

21. **ALWAYS** turn power switch to OFF anytime fryer is not in use.

22. **DO NOT** use vent ball with ball-end deadweight.

23. **INSTALLATION** of this fryer may require the use of a licensed electrician. Check local codes.

 **WARNING: Contamination Hazard**

Can cause serious illness or damage to equipment >>
Clean equipment daily to avoid potential contamination hazard.

Clean equipment daily to prevent buildup of food residue or chlorides, which can also damage stainless steel and contaminate food. Failure to follow proper cleaning procedures can void your warranty.

Prior to using equipment for the first time, perform the daily cleaning procedure listed on pages 15-17.

 **CAUTION: Electrical Hazard**

Can cause injury >> Do not attempt to service this equipment unless you are a licensed electrician or trained servicer.

1. Because this equipment utilizes high voltage, it should only be serviced by a licensed electrician or trained servicer. Attempting to service the equipment yourself could result in serious, potentially fatal injuries. Please make this page available to the servicer.
2. If an electrical shock is felt when touching equipment, shut off power immediately (either pull power cord or turn off circuit breaker) and call a trained servicer for repair. Failure to do so could result in serious, potentially fatal injuries.
3. Always turn power switch off when equipment is not in use.
4. Components to be replaced only with Winston-supplied components.
5. Wire (ground) lug on rear of equipment to be used for connection of equipotential conductor device.
6. Equipment must be grounded.

 **WARNING: Safety Hazard,**
Intended Use

Can cause serious injury or damage to equipment >>
Supervise untrained, young, or handicapped persons.

1. This equipment is not intended for use by persons (including children) with reduced physical, sensory, or mental capabilities, or lack of experience and knowledge, unless they have been given supervision or instruction concerning use of the equipment by a person responsible for their safety.
 2. Children should be supervised to ensure that they do not play with the equipment.
 3. This equipment is intended to be used for commercial applications, for example in kitchens of restaurants, canteens, hospitals and in commercial enterprises such as bakeries, butcheries, etc., but not for continuous mass production of food.
-

 **WARNING: Safety Hazard,**

Can cause serious injury or damage to equipment >>
Install equipment in such a manner that water cannot contact cooking oil in fryer.

 **CAUTION: Contamination Hazard**

Prior to using equipment for the first time, perform the daily care procedure listed on pages 15-17.

COMPONENT IDENTIFICATION - PRESSURE FRYER

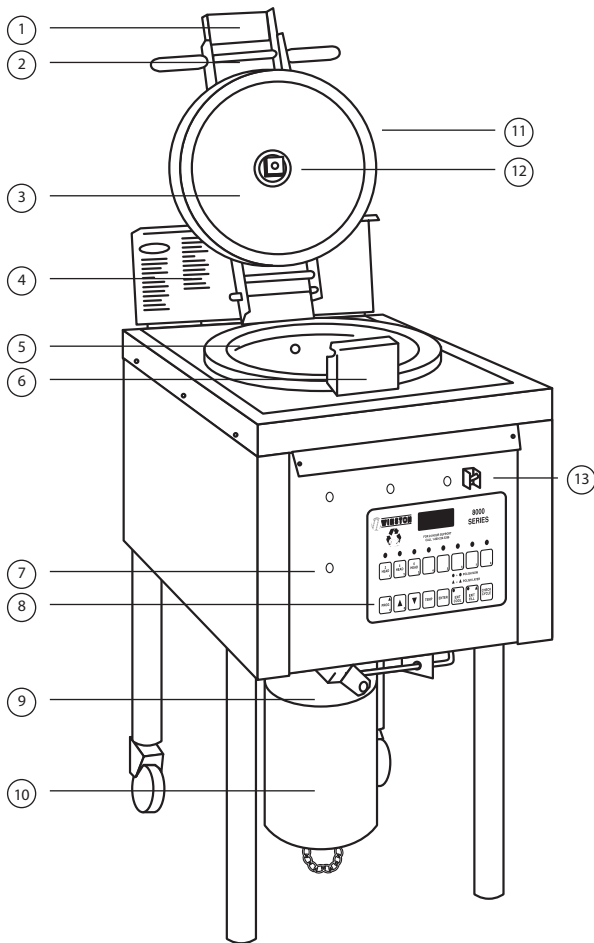

Please note that the drawings and descriptions differ from pressure fryer to open fryer.

1. **Lid Lock** - Manually operated lock that prevents opening of fryer lid prior to release of pressure through lid valve.
2. **Handlebar** - Used to raise and lower lid and secure lid to lid lock block.
3. **Lid** - (pressure fryers only) Pressurizes fryer when lowered and locked in place with heated cooking oil in cookpot.
4. **Warning Label Panel** - Instructions intended to advise operators of potential hazards involved when using fryer.
5. **Cookpot** - Stainless steel vessel that holds heated cooking oil.

6. **Lid Lock Block** - Captures lid lock and handlebar assembly. Supports basket drain hook when draining fryer basket.
7. **High Limit Thermostat Manual Reset Button** - (located behind small metal plug) Used to reset the thermostat in the event that the High Limit Thermostat Lamp turns ON.

! DANGER: Burn Hazard

Can cause damage to equipment >> If the High Limit Thermostat Lamp turns ON it may indicate a serious problem with your fryer. To reset the High Limit Thermostat, allow the cooking oil to cool to below 375°F (190°C). Press in the High Limit Reset button. When the cooking oil heats up, if the High Limit Thermostat Lamps turns ON again, turn the fryer power switch OFF, disconnect fryer from power, and call a service technician for repair. If the High Limit Thermostat Lamp tends to turn on frequently, call a service technician for repair.

8. **Control Panel** - will include the following components:
 - **Controller** - regulates cooking times and temperatures.
 - **Power Lamp** - controlled by Power Switch. Indicates electrical current is applied to fryer circuitry.
 - **Heat On Lamp** - indicates when heaters are on.
 - **High Limit Lamp** - comes on if cooking oil temperature reaches 410°F (210°C); heaters automatically shut off.
9. **Drain Valve** - When open (handle down), empties cooking oil from cookpot.
10. **Collector** - "Cold Zone" container that catches particles falling from cooking product.
11. **Lid Gasket** (pressure fryers only) - Seals between lid and cookpot to maintain pressure in cookpot (reorder #PS1891).
12. **Lid Valve** - (pressure fryers only) Spring loaded pressure release valve used to back up main vent system at rear of fryer. Also releases pressure at end of cook cycle by means of lid lock.
13. **Power Switch** - Allows operator to turn electrical power on and off.

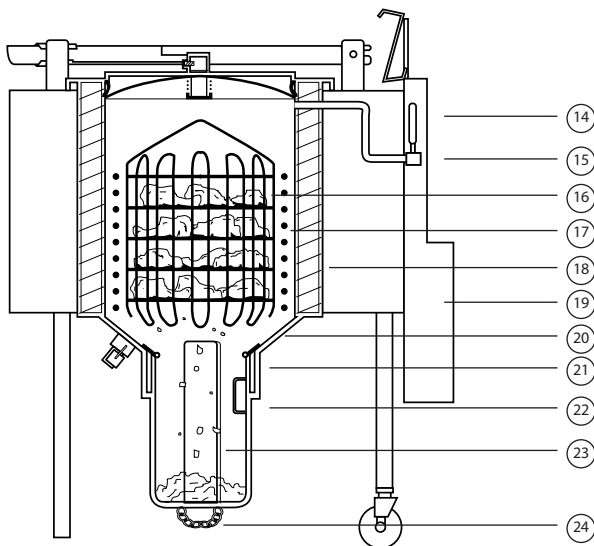

Diagram for PF Series

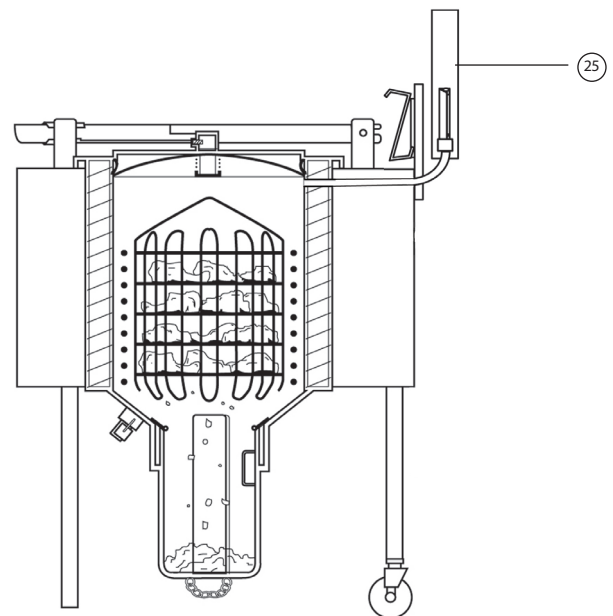
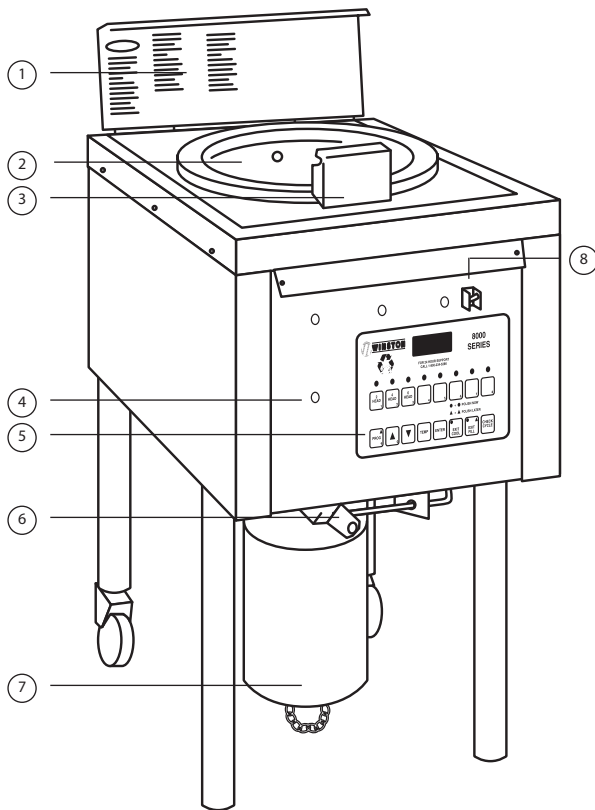

Diagram for LP series (difference noted)

- 14. **Dead Weight** - (pressure fryers only) Weight in main vent assembly that determines amount of pressure built up in cookpot when heating cooking oil with lid down.
- 15. **Vent Block** - (PF Models only) Has hole through which steam passes as controlled by dead weight assembly when fryer is pressurized.
- 16. **Clamshell Basket** - (see ACCESSORIES-page 9).
- 17. **Heater Coils** - Electrical elements that heat cooking oil.
- 18. **Insulation** - Surrounds cookpot to help maintain cooking oil temperature by reducing heat loss.
- 19. **Muffler** - (PF Models only) Collects condensed steam and muffles steam vent noise at end of cook cycle.
- 20. **Cone** - Supports basket and directs falling particles from cooking product into collector. Stirring of cooking oil should not be attempted below cone after first round of cooking each day.
- 21. **Collector Gasket** - Seals between collector and cookpot wall to maintain pressure in cookpot. (reorder #PS1892).
- 22. **Collector Lifting Loop** - With basket drain hook, means by which collector can be handled from above and pulled up through cookpot.
- 23. **Heat Plate** - (See ACCESSORIES - page 9).
- 24. **Collector Chain Handle** - handle for dumping contents of collector.
- 25. **Main Vent Assembly** - (LP Models only) Exhaust tube through which excess steam is released into the air.

COMPONENT IDENTIFICATION - OPEN FRYER



1. **Warning Label Panel** - Instructions intended to advise operators of potential hazards involved when using fryer.
2. **Cookpot** - Stainless steel vessel which holds cooking oil.
3. **Lid Lock Block** - Supports basket drain hook when draining fryer basket.
4. **High Limit Thermostat Manual Reset Button** - (located behind small metal plug) Used to reset the thermostat in the event that the High Limit Thermostat Lamp turns ON.

DANGER: Burn Hazard

Can cause damage to equipment >> If the High Limit Thermostat Lamp turns ON it may indicate a serious problem with your fryer. To reset the High Limit Thermostat, allow the cooking oil to cool to below 375°F (190°C). Press in the High Limit Reset button. When the cooking oil heats up, if the High Limit Thermostat Lamps turns ON again, turn the fryer power switch OFF, disconnect fryer from power, and call a service technician for repair. If the High Limit Thermostat Lamp tends to turn on frequently, call a service technician for repair.

5. **Control Panel** - will include the following components:
 - **Controller** - regulates cooking times and temperatures.
 - **Power Lamp** - controlled by Power Switch. Indicates electrical current is applied to fryer circuitry.
 - **Heat On Lamp** - indicates when heaters are on.
 - **High Limit Lamp** - comes on if cooking oil temperature reaches 410°F; heaters automatically shut off.
6. **Drain Valve** - When open (handle down), empties cooking oil from cookpot.
7. **Collector** (long or short) - "Cold Zone" container that catches particles falling from cooking product.
8. **Power Switch** - Allows operator to turn electrical power on and off.

- 9. **Clamshell Basket** - (see ACCESSORIES - page 9).
- 10. **Heater Coils** - Electrical elements that heat cooking oil.
- 11. **Insulation** - Surrounds cookpot to help maintain cooking oil temperature by reducing heat loss.
- 12. **Cone** - Supports basket and directs falling particles from cooking product into collector. Stirring of cooking oil should not be attempted below cone after first round of cooking each day.
- 13. **Collector Gasket** - Seals between collector and cookpot wall. (reorder #PS1892).
- 14. **Collector Lifting Loop** - With basket drain hook or long hook, means by which collector can be handled from above and pulled up through cookpot.
- 15. **Heat Plate** - (See ACCESSORIES - page 9) Heat plate is only used with long collector, not short collector.
- 16. **Collector Chain Handle** - handle for dumping contents of collector.

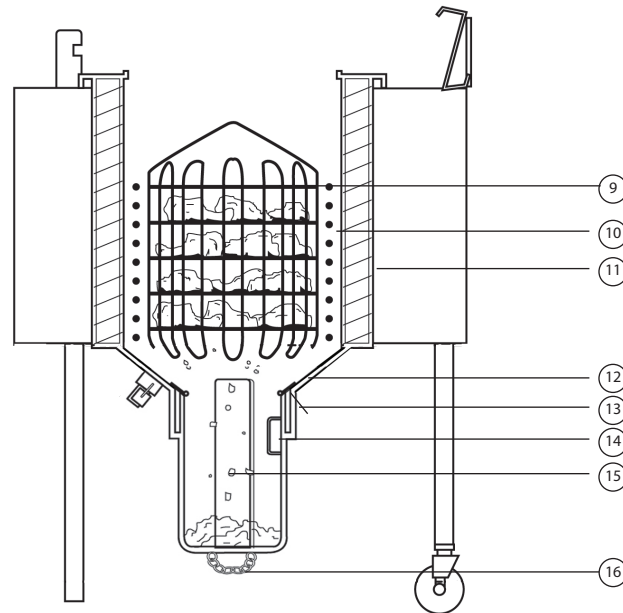

Diagram for OF Series

ACCESSORIES (sold separately)

Basket Drain Hook

(Order #PS1154/1)

- Lower and raise basket
- Remove collector
- Lower and raise heat plate

**Heat Plate**

(Order #PS1034 or PS1918)

- Transfers heat from Cooking Zone to Cold Zone to keep cooking oil hot.

**Clamshell Basket**

4 Head (Order #PS1159) or 6 Head (Order #PS1163)

- Allows product to be fully immersed and completely surrounded by cooking oil.

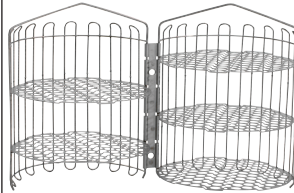
**Safety Gloves**

(Order #PS1001)

- Helps protect operator from hot cooking oil

**Stirring Tool**

(Order #PS1179)

- Used to stir cooking oil and break apart solidified pieces.

**Displacement Tool**

(Order #PS1209)

- Forces cooking oil up through drain valve to allow safe removal of collector.

**Spatula**

(Order #PS1979)

- Used to scrape residue from sides of cookpot.

**White Teflon Brush**

(Order #PS1120)

- Used to clean heaters between cooking rounds when cooking oil is hot.

**Qtr rack basket, wire**

4-hd (Order PS2838)

6-hd (Order PS2839)

Wire shelf kit (Order PS2837-25)

- Allows product to be fully immersed and completely surrounded by cooking oil.



ASSEMBLY OF FRYERS

CAUTION: Contamination Hazard

Can cause serious illness>>> Prior to using equipment for the first time, perform the daily cleaning procedure listed Under Daily Care on pages 15 through 17.

Before beginning the assembly process, wipe out cookpot and collector with damp, lint-free towel. This removes any dust or debris that may have accumulated. Never use water in the fryer.

1. After uncrating your fryer, you will find two sets of o-ring gaskets – two large and two small. (OF Models do not receive the large gaskets, which are for the lid.)

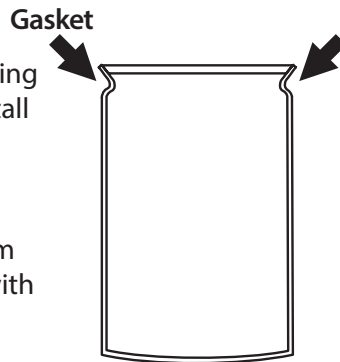

FIGURE 1

2. Lubricate the smaller o-ring with cooking oil and install in groove at top of collector (see Figure 1).
3. Install collector in bottom of fryer and gently tap with stirring tool until it seats into place.

4. Check to determine that drain valve is closed. (See Figure 2).

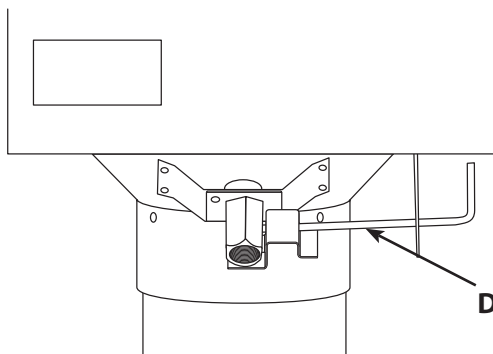

FIGURE 2

Drain Valve Closed

Rotated clockwise up and back as far as handle will move. To open, pull counter-clockwise forward and down.

5. Fill with cooking oil to one inch below Minimum fill line. Oil will expand as it is heated. Check oil level again once it has heated to cooking temperature to verify that oil level is between Minimum and Maximum marks.

DANGER: Fire Hazard

Fire or heater damage may occur when heaters are turned ON unless they are fully covered with cooking oil.

6. Lubricate large o-ring with cooking oil and install in groove around edge of lid.
7. Check to be sure that main vent assembly and dead weight (pressure fryers only) are in place at rear of fryer. (See figures 23 and 24, page 16).

OPERATING INSTRUCTIONS

FILLING

The following filling procedure is to be used when cooking oil is changed or when oil is added for the first time.

CAUTION: Contamination Hazard

Can cause serious illness>> Prior to using equipment for the first time, perform the daily cleaning procedure listed Under Daily Care on pages 15 through 17.

CAUTION: Burn Hazard

Can cause serious injury>> Cooking oil may be hot enough to burn you. Be careful when moving containers of liquid cooking oil.

DANGER: Fire Hazard

Can cause serious injury>> Fire or heater damage may occur when heaters are turned ON unless they are fully covered with cooking oil.

1. **Turn off** Power Switch.
2. **Clean Fryer** per daily cleaning procedure - see pages 15-17.
3. **Lubricate Lid Gasket and Collector Gasket** with cooking oil before placing on fryer.
4. **Check Collector and Drain Valve** - Make sure collector with gasket is seated and drain valve is closed (handle back – see Figure 3). Always place lifting loop in front. This will allow the collector to be removed with ease.
5. **Add Cooking Oil** - Liquid or solid cooking oil may be used. Melt solidified cooking oils in tender or other means and pump into fryer. Add enough cooking oil to raise liquid to within one inch of Minimum oil level line (see Figure 4, page 13). As oil heats, it expands. Check level again once oil has heated to verify that level is between Minimum and Maximum marks.
Capacities:
PF or LP46, or OF49:
Food product = 14 lbs (6.35 Kg)
Cooking oil = 64 lbs (28.8 Kg) or 8.15 gal (30.85L)

PF or LP 56, or OF59:
Food product = 18 lbs (8.2 Kg)
Cooking oil = 75 lbs (33.8 Kg) or 9.55 gal (36.15L)

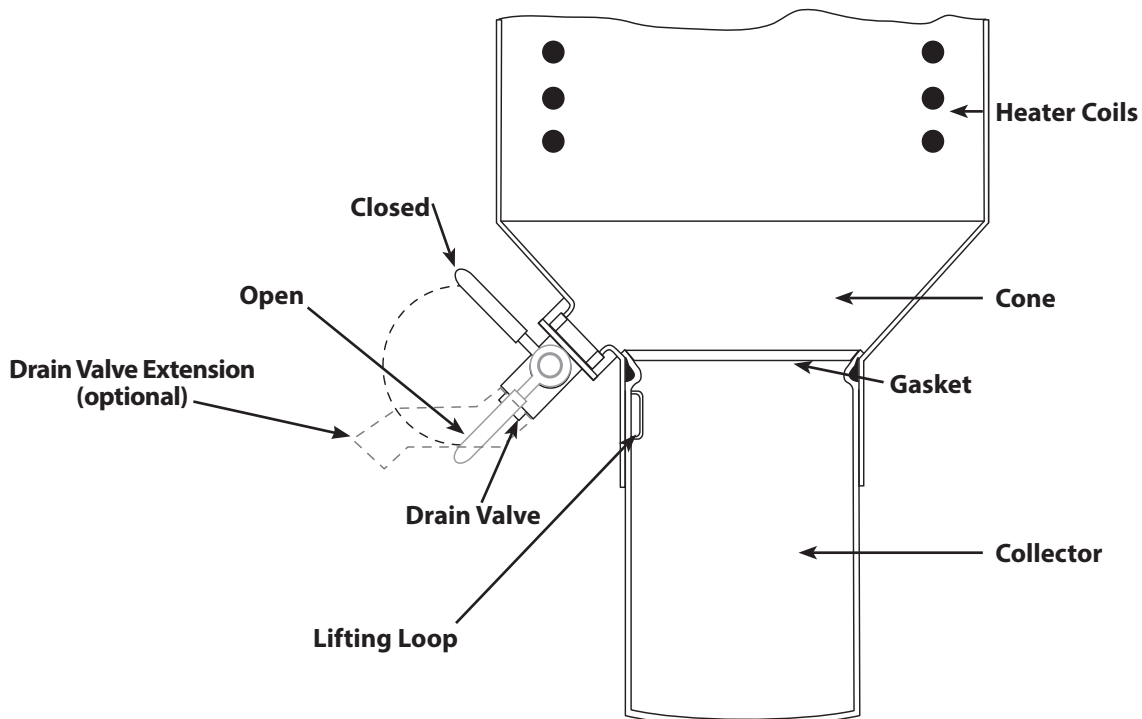

FIGURE 3 - Some features have been omitted to show greater detail.

OPERATING INSTRUCTIONS

WARM-UP

Failure to follow procedure below may result in first batch of cooked food being off-color and improperly done.

! DANGER: Fire Hazard

Fire or heater damage may occur when heaters are turned ON unless they are fully covered with cooking oil.>>Do not turn on power unless all heater coils are completely covered by cooking oil. Fill shortening to a level between the Maximum and Minimum oil level lines found on the inside of the cookpot (see Figure 4).

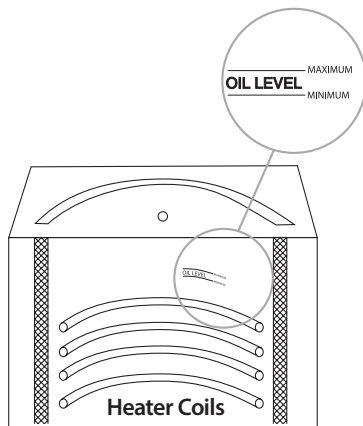

FIGURE 4

! DANGER: Fire Hazard

Can cause serious injury.>>Do not place any liquids in cookpot other than cooking oil.

1. Turn on circuit breaker and Power Switch.
2. Set controls to start warm-up process by pressing the channel button which contains the desired programmed times and temperatures (see Programming pages 19-27).
3. **STIR** Signal may come on in some older models. If **STIR** Signal comes on **IGNORE - DO NOT STIR FRYER. IF FRYER IS STIRRED AT THIS TIME, AQUALERT® SYSTEM MAY BE ACTIVATED*** - After temperature reaches 250°F display shows cooking oil temperature. It will then display Drop message.

*NOTE: See Aqualert® in on page 28 for a complete explanation.

4. Deep stir cooking oil, with stirring tool, into collector vigorously for at least 15 seconds.
- 1st STIR
5. Drop message will change to cooking oil temperature. **DO NOT** stir cooking oil while cooking oil temperature is displayed.
6. After a little while, drop message will be displayed.
7. Deep stir cooking oil, with stirring tool, into collector vigorously for at least 15 seconds.
- 2nd STIR
8. Drop message will change to cooking oil temp. **DO NOT** stir cooking oil while cooking oil temp is displayed.
9. After a little while, drop message will be displayed.
10. Deep stir cooking oil, with stirring tool, into collector vigorously for at least 15 seconds.
- 3rd STIR
11. Drop message will change to cooking oil temp. **DO NOT** stir cooking oil while cooking oil temperature is displayed.
12. After a little while, drop message will be displayed.

! CAUTION: Fire Hazard

Hot Surfaces>> Feel bottom of collector – must be hot to touch. If not, deep stir cooking oil vigorously again for at least 15 seconds.

14. Continue to repeat stirring and letting temperature rise to Drop until collector is hot to touch.
15. Lower Heat Plate into collector using basket drain hook (Figure 5).
16. Oil Level - Add or remove cooking oil so that it is at a level between the Maximum and Minimum Level marks. (Figure 4).

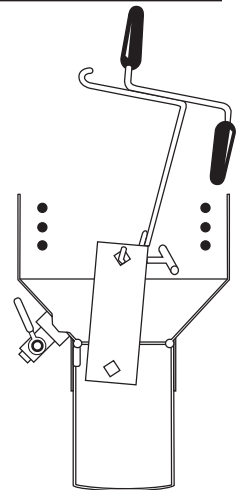

FIGURE 5

! DANGER: Fire Hazard

Can cause serious injury.>>Fire or heater damage may occur when heaters are turned ON unless they are fully covered with cooking oil.

17. When collector bottom feels hot and Drop Signal comes on, fryer is ready for cooking. NOTE: Collector Bottom **MUST BE HOT** for product to cook properly.

OPERATING INSTRUCTIONS

CLAMSHELL BASKET LOADING

The procedure outlined below illustrates the loading process for chicken pieces. Other food products should be loaded in a similar manner. Note opening in center of shelves which is accentuated to show importance of not packing products in too tightly, thus restricting cooking oil flow.

! CAUTION: Burn Hazard

Can cause serious injury.>>To help prevent product from sticking, before loading any basket for the first time each day, using safety gloves, coat a clean basket by dipping in hot cooking oil.

Load basket shelves from top down, starting at shelf #2, then #3, etc. (Do not use shelf #1 when cooking products that may float out of basket. Shelf #1 is basket lid.)

NOTES:

- Food pieces may touch but should not overlap.
- Use lower shelves when cooking less than full basket.
- Load shelves to allow good cooking oil flow around product.

6 head clamshell basket shown loaded with chicken for pressure frying. Shelf #2 is usually loaded with legs and thighs; shelf #3 - wings; shelf #4, 5, 6, - thighs, keels and ribs; shelf #7 - thighs (Figure 6).

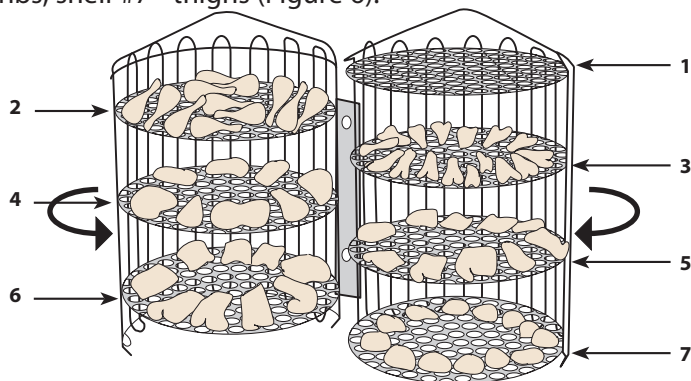

FIGURE 6

4 head clamshell basket would be loaded similarly to six head basket using shelves #2 through #5 as shown (Figure 7).

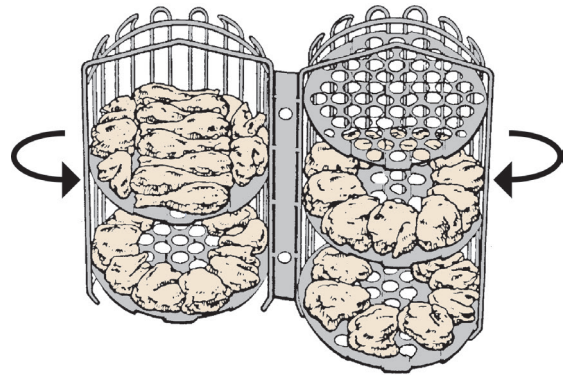

FIGURE 7

QUARTER RACK BASKET LOADING

With Quarter Rack Baskets (Figure 8), load pans and slide into rack.

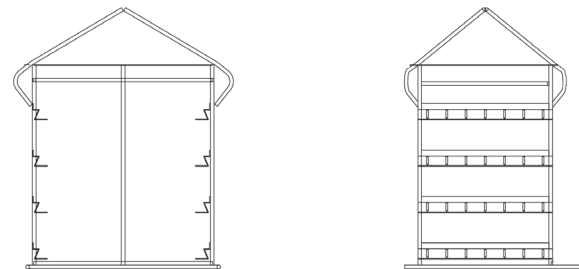
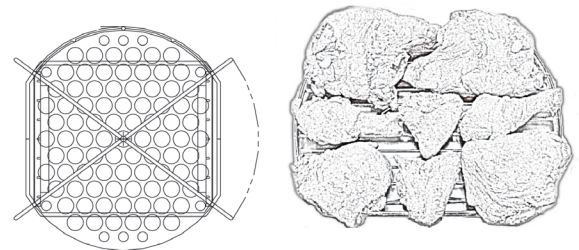

FIGURE 8

Chicken should be placed on the rails, **hanging over slightly**. Use the curve of the chicken pieces to determine how to lay chicken on the rack in a manner that will provide as much space between chicken pieces as possible.

Load from the bottom up and unload from the top down. After all chicken is placed on the rack, check to make sure pieces are not touching too much.



OPERATING INSTRUCTIONS

NOTE: Your cooking procedure may be specified to you through franchise agreement (or otherwise); if so, disregard the following. Refer to Safety, pages 2-4, regardless of procedure followed.

1. **Complete Warm-Up Process** - see OPERATION INSTRUCTIONS: WARM-UP page 12.
2. **Follow basket loading procedure on page 13.**

! DANGER: Burn Hazard

Can cause serious injury or death >> When I/OAD signal comes on, use safety gloves and basket drain hook to lower basket slowly into hot cooking oil (Figure 9).

4. **Open frying:** Leave lid open.

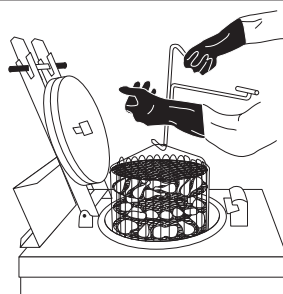

FIGURE 9

Pressure frying:

! DANGER: Burn Hazard

Can cause serious injury or death >> To safely close lid:

- A. Use both hands on handlebar to lower lid. (Figure 10)
- B. Pull handlebar completely into lid lock block so that lid lock pops up (clank sound) into its straight, locked position.

5. Start cook cycle by pressing the channel button. LED timer will begin countdown from programmed time.

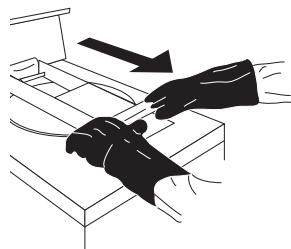

FIGURE 10

6. **OPENING LID** - at the end of the cook cycle (timer at 00:00), a buzzer will sound indicating that the lid can be opened and the basket can be removed from the fryer. Cancel the buzzer by pressing the channel button.

! DANGER: Burn Hazard

Can cause serious injury or death >> To safely open lid:

- A. Wait until cook cycle is finished (timer at 00:00 and buzzer sounds).
- B. Do not touch handlebar to open lid until pressing down on lid lock causes the lid to lower (figure 11)
- C. Then with the lid in the lowered position, use one hand to move handlebar to open (figure 12)

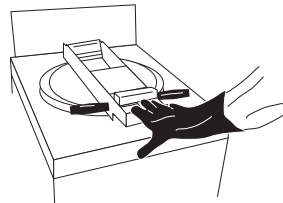

FIGURE 11

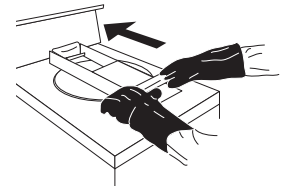

FIGURE 12

7. **Basket Removal**

! DANGER: Burn Hazard

Can cause serious injury or death >> Use safety gloves and basket drain hook to lift basket out of cooking oil. Rest basket on drain hook in lid lock block at 45° angle draining excess surface oil for 15 seconds (Figure 13).

8. **Unload Basket** (Figure 14). Place cooked products on corrugated tray and turn cavity (bone) down where applicable. Place tray in holding cabinet.

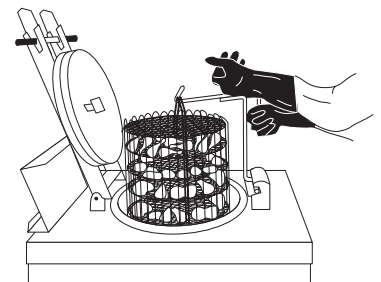

FIGURE 13

9. **Cleaning After Each Round** - scrape crust line from pot with spatula (supplied) (Figure 15). Brush heater coils on the front and back side with the white Teflon brush (supplied). Wipe excess moisture off of fryer lid with a dry towel.

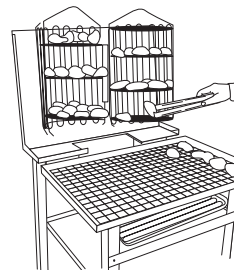

FIGURE 14

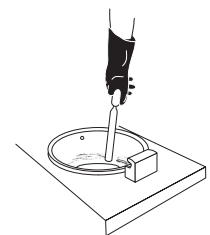

FIGURE 15

10. **! DANGER: Burn Hazard**

Can cause serious injury or death >> Should a STIR signal come on (in some older models), do not stir cooking oil below cone in fryer (see Figure 16) after the first round of cooking each day. Cracklings stirred below cone may cause hot cooking oil to rapidly rise up and out of the fryer. You can be burned or badly hurt.

11. Press 'exit cool' button to begin warm-up for cooking next round.

Cone: Do not stir below the bottom of the cone after the first round of cooking each day.

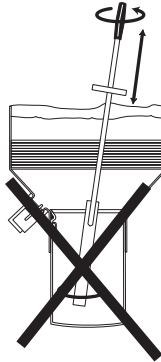

FIGURE 16

DAILY CARE

! CAUTION: Contamination Hazard

Can cause illness.>> Prior to using equipment for the first time, perform the daily cleaning procedure listed below.

Most of the following Daily Cleaning Procedures apply to both OPEN and PRESSURE fryers. Those that apply to PRESSURE fryers only are specified as such.

NOTE: Emptying the collector and filtering may have to be done at some point during the day, depending upon how many rounds are cooked and how much breading builds up in the collector. Typically 20 rounds of product may be cooked before having to empty the collector and filter the cooking oil.

! DANGER: Burn Hazard

Can cause serious injury.>> Drain cooking oil from fryer and then empty collector at least twice a day. If you don't, cooking oil may boil out of the fryer, burn you, and make floor slippery.

For All Open and Pressure Fryers

1. **Turn Fryer Off.** Turn circuit breaker OFF or disconnect electrical power from fryer.
2. **Scrape Crust Line** from cookpot with spatula and

brush heater coils (Figure 15).

3. **Place metal pan** under open collector area.

4. **! DANGER: Burn Hazard**

Can cause serious injury.>> Drain hot cooking oil only into metal containers. Place container or shortening tender under drain valve and open valve by flipping handle down. Allow cooking oil to cool before further handling. (Figure 17)

5. **Remove Heat Plate** - Inspect from above to see that cooking oil has drained out of cookpot down to level of drain valve. Wearing safety gloves, remove heat plate with basket drain hook (Figure 18) and place in

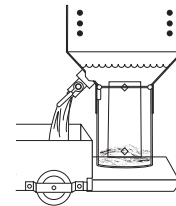

FIGURE 17

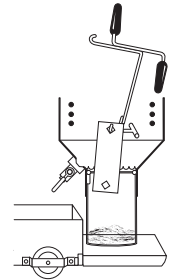

FIGURE 18

safe area to cool.

6. **! CAUTION: Burn Hazard**

Can cause serious injury.>> Wearing safety gloves, with drain valve still open, use displacement tool to force enough cooking oil up and out of drain valve to allow safe removal of collector (Figure 19).

7. **Close Drain Valve.**

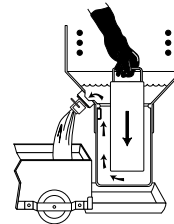

FIGURE 19

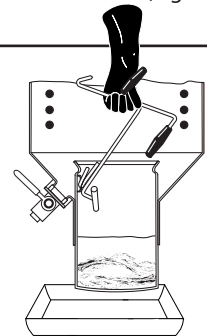

FIGURE 20

8. **! CAUTION: Burn Hazard**

Can cause serious injury.>> Wearing safety gloves, remove collector with basket drain hook placed in collector lifter loop (Figure 20).

For Pressure Fryer Models Only:

DAILY CARE (Continued)

9. Remove and Clean Collector Gasket

Note: Gasket life may be prolonged by doing the following:

- Keep spare set to alternate nightly. Lubricate with clean cooking oil before using.
- Clean gaskets after daily use and store in a container of water in cooler.
- Do not stretch gasket more than necessary to place on collector. Discard gasket if cracked or breaking.
- Never strike cookpot or collector with spatula or other tools. Gaskets may be damaged on sharp, rough edges that result from such striking.

10. ! DANGER: Burn Hazard

Can cause serious injury.>>Do not use "boil out" method of cleaning fryer or fill fryer with any liquid other than cooking oil. Fryer is made to be pressurized only with cooking oils. If pressurized with other liquids, you may be burned, badly hurt, or killed.

11. Scrub Heater Coils with white Teflon brush. Clean heaters, heater holders, and all of cookpot (Figure 21). Do not use steel wool.



FIGURE 21

12. Rinse inside of cookpot with cooking oil only.

13. Wash Accessories (using hot water only) including collector (clean gasket groove), gasket, heat plate, utensils, basket, etc., at sink. Wipe dry.

14. ! DANGER: Burn Hazard

Can cause serious injury.>>Don't splash water on outside of fryer or wash outside of fryer with hose. If you do, you may get water into hot cooking oil, causing it to boil over, or you may get electrical components wet, causing a short circuit. Clean outside of fryer with damp towel (do not use steel wool) and wipe dry.

15. ! CAUTION: Burn Hazard

Can cause serious injury.>>Muffler (on PF Models) may be hot from steam condensation. Wear safety gloves. Remove muffler (Figure 22), empty and wash in sink.

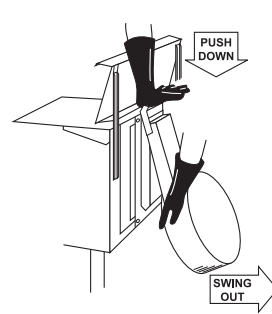

FIGURE 22

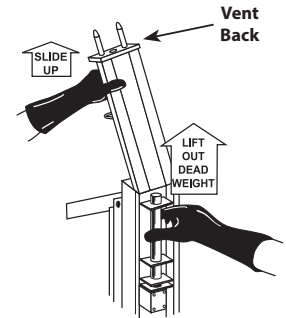

FIGURE 23 (PF Models)

16a. For PF Models: Clean Vent Components Remove deadweight and wipe out vent block (Figure 23). Clean deadweight at sink, towel dry and place back in vent assembly.

16b. For LP Models: remove deadweight from main vent assembly on rear of fryer by lifting tube. Deadweight is under tube. (See Figure 24). Rinse deadweight and tube (inside and out) with hot water at sink. Towel dry. Reassemble Deadweight and tube. Check O ring where vent tube connects.

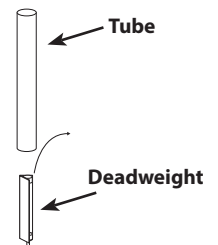

FIGURE 24 (LP Models)

DAILY CARE

Lid Cleaning Instructions (Pressure Fryers Only)

1. Remove lid from fryer and disassemble components as shown below. Remove the retainer from the lid valve before removing the lid lock and handlebar (the lid lock will help to hold the lid valve while unscrewing the retainer).

CAUTION: Burn Hazard

Can cause serious injury.>>Do not submerge the pressure gauge (if supplied) or the pressure relief valve (if supplied) in water. Do not attempt to remove the pressure gauge from the lid. Do not remove the pressure relief valve from the lid. Do not attempt to force foreign objects inside the pressure gauge or pressure relief valve.

2. Wash all parts at sink EXCEPT THE LID VALVE, PRESSURE RELIEF VALVE, AND PRESSURE GAUGE and dry with a towel. Wipe outside of gauge and lid valve with a damp cloth, then wipe dry.

3. Lubricate o-ring with cooking oil and reassemble lid. Tighten retainer hand-tight.
Note: Flat end of spring faces retainer on PF Fryer; large end of spring faces retainer on LP Fryer.
4. Lubricate lid gasket with cooking oil and place on lid in groove.

DANGER: Burn Hazard

Can cause serious injury.>>Replace lid on fryer only if fryer is free of any water.

5. When re-assembling lid make sure lip on lid lock is positioned properly into slot of lid valve.

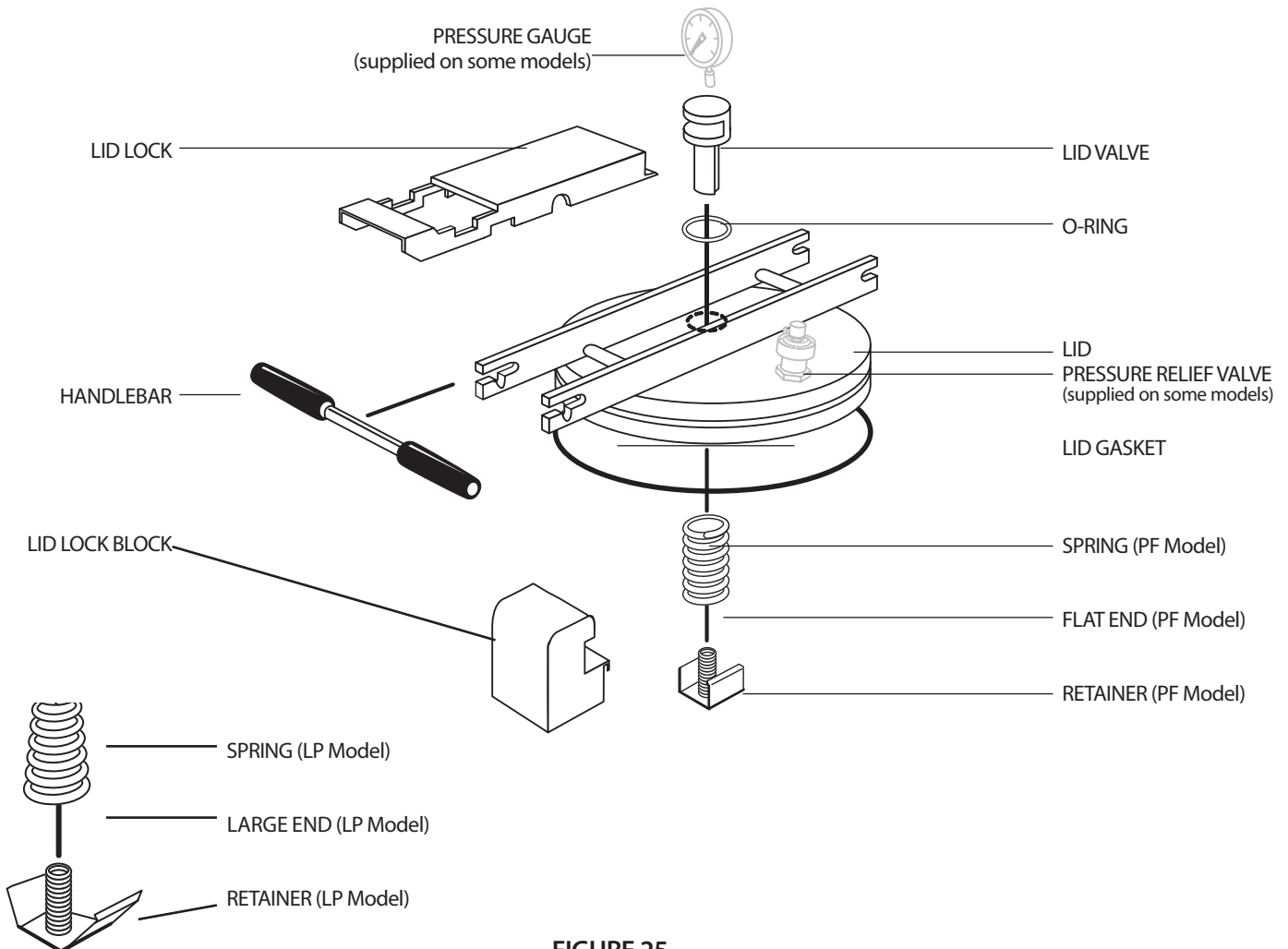
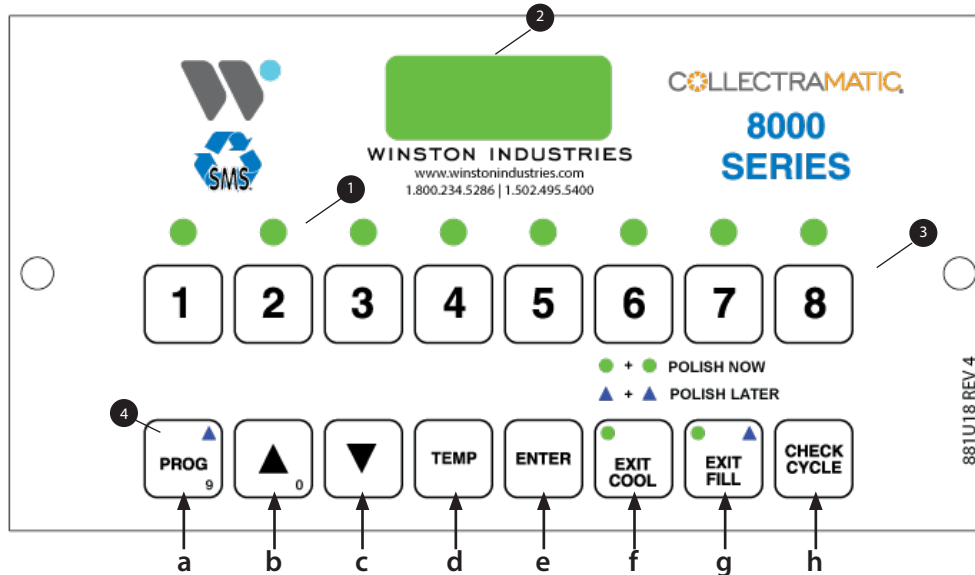

FIGURE 25



CONTROLS - 8000 SERIES



1. **LED Program Lamps** indicate which channel is selected when lit above that channel.
2. **Display** readout indicates time or temperature by pressing appropriate buttons.
3. **1 - 8 Channel Buttons** provide operator the ability to select desired cooking cycles. Also starts desired cycle after fryer has preheated.
4. **Programming Buttons**
 - a. **Program Button** - Press button to start programming sequence.
 - b. **▲ Button** - Increases value in program.
 - c. **▼ Button** - Decreases value in program.
 - d. **Temp Button** - Displays current oil temperature when depressed.
 - e. **Enter** - Enter value into programming.
 - f. **Exit Cool Button** - Switches between cool (idle) mode and heat mode. When in cool mode, oil temperature is limited to 250°F.
 - g. **Exit Fill Button** - Used during polishing mode. Polishing mode must be initialized and requires specialized training. Call Winston Customer Service for more information.
 - h. **Check Cycle button** - Displays total time of all time values added together. Then it displays all values for cycle in selected channel.

Disregard this information if model was purchased with alternate controls (or no controls).

PROGRAMMING

Programming Time/Temperature Profiles for the Winston 8000 Series Controller

The 8000 Series Controller has 16 push buttons. The eight numbered buttons in the top row are called channel buttons. The lower row of buttons are for programming the control. Programming allows one of four different processes to be assigned to each *channel*. The processes available for the 8000 Series Control are PC1, PC2, PC5, and PC6.

Process #1 (PC 1) allows assigning up to 6 different temperatures to a channel. The temperatures can be set to occur at different times during the cook cycle. For instance, a cooking cycle for a load of chicken can be set up as shown in the following table using PC 1. In this case the chicken would cook at 350°F (177°C) for 1 minute (from 15:00 down to 14:00), then the temperature setting would change to 340°F (171°C) for the next minute (from 14:00 to 13:00), and so on.

Process #2 (PC 2) allows assigning up to six different temperatures and times to a channel just like PC 1. PC 2 also **adds the capability for Load Compensation** (automatically detects the amount of product added to

the fryer and adjusts the time that the product cooks so that it is properly done when the cook cycle finishes), Straight Line Timing (like PC 1), or a combination of the two. PC 2 also allows programming of up to three different audible pre-alarms (Buzzer) to sound at any time during the cook cycle.

Process #5 (PC 5) allows assigning of one temperature and one time to a channel. Note: Process #5 may not be available on some models.

Process #6 (PC 6) allows assigning of two temperatures and two times to a channel. Note: Process #6 may not be available on some models.

When programming, the display scrolls through several screens showing the current settings for the fryer. The first two screens show the software ID numbers. The third screen displays the capacity of the fryer expressed in number of chickens it will cook at one time (4hd or 6hd). The fourth screen indicates whether it is a pressure or open type fryer. The fifth screen shows the size of the chicken the fryer is programmed to cook (certain fryer models will automatically adjust the programmed settings if the chicken size setting is changed). The sixth screen indicates whether the fryer is set to display Fahrenheit or Centigrade.

| PC 1 - 6 TEMPERATURES, 6 TIMES | | | |
|--|------|---|-------|
| (These are example settings only. Temperatures shown in Fahrenheit.) | | | |
| FIRST TEMPERATURE (H1) | 350° | FIRST TIME = total cook time (T1), H1 temp starts | 15:00 |
| SECOND TEMPERATURE (H2) | 340° | SECOND TIME = time remaining when H2 starts (T2) | 14:00 |
| THIRD TEMPERATURE (H3) | 330° | THIRD TIME = time remaining when H3 starts (T3) | 13:00 |
| FOURTH TEMPERATURE (H4) | 320° | FOURTH TIME = time remaining when H4 starts (T4) | 11:30 |
| FIFTH TEMPERATURE (H5) | 310° | FIFTH TIME = time remaining when H5 starts (T5) | 9:25 |
| SIXTH TEMPERATURE (H6) | 300° | SIXTH TIME = time remaining when H6 starts (T6) | 5:15 |



FRYER GUIDELINES - BASIC SETTINGS FOR 8000 SERIES CONTROL

| Product | Est. Cook Time (min) | Process Type | H1 | T1 | O/P | H2 | T2 | O/P | H3 | T3 | O/P | H4 | T4 | O/P | H5 | T5 | O/P | H6 | T6 | O/P |
|--|----------------------|----------------------|-----|-------|-----|-----|-------|-----|-----|------|-----|-----|------|-----|-----|-----|-----|-----|----|-----|
| Fried Chicken | | | | | | | | | | | | | | | | | | | | |
| Very Crispy (Double Breaded) | 14-15 | Process 1 (lid open) | 325 | 15:00 | O | 325 | 0:00 | N/A | | | | | | | | | | | | |
| Crispy | 14-15 | Process 1 | 350 | 15:00 | P | 325 | 13:30 | P | 310 | 6:00 | P | 300 | 1:30 | O | 300 | O | N/A | | | |
| Crispy (extended oil life) | 15-16 | Process 1 | 325 | 15:00 | O | 325 | 0:00 | | | | | | | | | | | | | |
| Medium Crisp | 14-15 | Process 1 | 350 | 15:00 | P | 290 | 13:30 | P | 300 | 5:00 | P | 300 | :30 | O | 306 | O | N/A | | | |
| Medium (ext. oil life) | 15-16 | Process 1 | 310 | 15:30 | O | 310 | 0:00 | | | | | | | | | | | | | |
| Soft | 14-15 | Process 1 | 350 | 15:00 | P | 286 | 13:30 | P | 290 | 5:00 | P | 300 | 2:00 | P | 306 | :30 | O | 306 | O | N/A |
| Soft (ext. oil life) | 15-16 | Process 1 | 290 | 15:30 | O | 290 | 0:00 | | | | | | | | | | | | | |
| Chicken Wings | 12-15 | Process 1 | 350 | 13:30 | P | 325 | 9:00 | P | 300 | 2:00 | O | 310 | 1:00 | O | 310 | O | N/A | | | |
| Chicken Strips/Filets | 7-10 | Process 1 | 325 | 8:30 | P | 290 | 7:30 | P | 300 | :30 | O | 300 | 0:00 | N/A | | | | | | |
| Chicken Nuggets | 7-10 | Process 1 | 325 | 7:30 | P | 310 | 6:00 | O | 310 | 0:00 | N/A | | | | | | | | | |
| Other Poultry | | | | | | | | | | | | | | | | | | | | |
| Turkey, Whole (12-14#) | 3-4 per lb | Process 1 | 290 | 50:00 | P | 300 | 1:00 | O | 300 | 0:00 | N/A | | | | | | | | | |
| Turkey Breast | 4 per lb | Process 1 | 290 | 15:00 | P | 300 | :30 | O | 300 | 0 | N/A | | | | | | | | | |
| Duck, Whole (Crispy) | 3-4 per lb | Process 1 | 350 | 15:00 | P | 330 | 13:30 | P | 310 | 6:00 | P | 300 | 1:30 | O | 300 | 0 | N/A | | | |
| Meats | | | | | | | | | | | | | | | | | | | | |
| Fried Ribs | 13-15 | Process 1 | 275 | 14:00 | P | 275 | :30 | O | 275 | O | N/A | | | | | | | | | |
| Pork Chops | 4-6 | Process 1 | 315 | 5:00 | P | 315 | :30 | O | 315 | O | N/A | | | | | | | | | |
| Seafood | | | | | | | | | | | | | | | | | | | | |
| Breaded Fish Filets | 4-6 | Process 5 | 350 | 5:00 | O | 350 | 0 | O | | | | | | | | | | | | |
| Shrimp | 4-6 | Process 5 | 350 | 5:00 | O | 350 | 0 | O | | | | | | | | | | | | |
| Vegetables | | | | | | | | | | | | | | | | | | | | |
| Onion Rings | 3-4 per 5 lbs | Process 5 | 350 | 3:30 | O | 350 | 0 | N/A | | | | | | | | | | | | |
| Potato Wedges | 10-12 | Process 5 | 325 | 12:00 | O | 325 | 0 | N/A | | | | | | | | | | | | |
| French Fries (#5) | 3-4 per 5 lbs | Process 5 | 350 | 3:30 | O | 350 | 0 | N/A | | | | | | | | | | | | |
| Finger Food Apps (cheese sticks, etc.) | 4-7 | Process 5 | 350 | 5:00 | O | 350 | 0 | N/A | | | | | | | | | | | | |

PROGRAMMING

By default, the controller opens the vent valve 30 seconds before the end of a pressure cook cycle. A buzzer will automatically sound at the end of the cook cycle when the timer reaches :00 (the display will then show **dOnE**) indicating it is time to open the lid (when pressure frying) and remove the cooked product. Cancel the buzzer sound by pressing the channel button.













Note: The fryer does not have to be ON to program except for "Running the Field Diagnostics" section. Also, to cancel out of the programming mode at any time, press and hold the  button for three seconds.

PROGRAMMING THE FRYER CONFIGURATION

Fryer Configuration adjusts the global fryer settings. This program allows you to set the fryer capacity from 4 to 6 head (default is 6 head), change the fryer from a pressure (default) to an open fryer, set the bird size (for frying chicken) from 2.5 lbs. (default) to 2.75 lbs., and change the temperature scale from Fahrenheit to Centigrade.

STEP 1 In sequence, press the following buttons to enter programming mode.

 then  then  then  then 

| | WHEN THE COMPUTER DISPLAYS | PRESS BUTTON/ACTION | NOTE |
|---------|----------------------------|--|--|
| Step 2 | PrOg |  | Indicates Programming mode. Press #8 to proceed. |
| Step 3 | PrCF |  | Program the fryer configuration. Press Enter to proceed. |
| Step 4 | 6 Hd |  or  | Modify the capacity setting. Choose 4Hd or 6Hd. |
| Step 5 | |  | Press ENTER to proceed. |
| Step 6 | PrES |  or  | Modify the pressure setting. Chose pressure (PrES) or open (oPEn). |
| Step 7 | |  | Press ENTER to proceed. |
| Step 8 | bi rd | | bird display momentarily. Factory setpoints for either a 2.5 lb. or 2.75 lb. bird. |
| Step 9 | 2.50 |  or  | Modify the bird size. Changing bird size automatically changes set points in certain channels for specific fryer models. |
| Step 10 | tScL | | tScL displays momentarily. |
| Step 11 | FAHr |  or  | Modify the temperature scale display. Choose Fahrenheit (FAHr) or Centigrade (Cent). |
| Step 12 | |  | Press ENTER to exit. |

Note: At any time during programming, time settings can be set to :00 indicating from that point on, the fryer will

cook at the last setting entered until the end of the cycle.



PROGRAMMING

PROGRAMMING THE SPEAKER PARAMETERS

Speaker Parameters allow you to adjust the speaker loudness and frequency (tone) settings.

STEP 1 In sequence, press the following buttons to enter programming mode.

then then then then

| | WHEN THE COMPUTER DISPLAYS | PRESS BUTTON/ACTION | NOTE |
|--------|----------------------------|---------------------|--|
| Step 2 | Prog | | Indicates Programming mode. Press #7 to proceed. |
| Step 3 | PrSP | | Program the loudness and the tone frequency. Press ENTER to proceed. |
| Step 4 | Loud | or | Loud displays momentarily. |
| Step 5 | Default is 6 bars (75%) | | Modify the speaker loudness indicated by vertical bars on display. |
| Step 6 | | | Press ENTER to proceed. |
| Step 7 | FrE | | FrE displays momentarily. |
| Step 8 | 1400 Default is 1400 | or | Modify the tone frequency in 100 Hz increments. |
| Step 9 | | | Press ENTER to exit. |

PROGRAMMING THE AUTOCOOL MODE TIMER

Automatic cool mode monitors the amount of time the fryer remains in drop mode. If the fryer is in drop mode, without cooking, for the programmed amount of time (in STEP 7 below) the controller will switch to cool mode.

STEP 1 In sequence, press the following buttons to enter programming mode.

then then then then

| | WHEN THE COMPUTER DISPLAYS | PRESS BUTTON/ACTION | NOTE |
|--------|----------------------------|---------------------|---|
| Step 2 | Prog | | Indicates Programming mode. Press #4 to proceed. |
| Step 3 | PrCL | | Program automatic cool mode parameters. Press ENTER to proceed. |
| Step 4 | CH | | CH displays momentarily. |
| Step 5 | 250F Default is 250° | or | Automatic cool mode (setback) temperature 250°F (121°C) minimum, 360°F (182°C) maximum. |
| Step 6 | | | Press ENTER to proceed. |
| Step 7 | Ct | | Ct displays momentarily. |
| Step 8 | :30 | or | Automatic cool mode timer. With the arrow buttons, modify in 1-minute increments from 0 to 60 minutes. :00 disables this feature. |
| Step 9 | | | Press ENTER to exit. |

Note: At any time during programming, time settings can be set to :00 indicating from that point on, the fryer will

cook at the last setting entered until the end of the cycle.

PROGRAMMING

PROCESS 1

Programming Process #1 (PC 1) - 6 temperatures, 6 times

STEP 2 In sequence, press the following buttons to enter programming mode.

STEP 1 First choose the channel you want to program.



| | WHEN THE COMPUTER DISPLAYS | PRESS BUTTON/ACTION | NOTE |
|---------|----------------------------|------------------------------|---|
| Step 3 | Prog | ENTER | Indicates Programming mode. Press ENTER to proceed. |
| Step 4 | Pc 1 | 1 | Press channel button #1 for selecting process #1. |
| Step 5 | | ENTER | Press ENTER to proceed. |
| Step 6 | H 1 | Heat Setpoints H1 through H6 | H1 displays momentarily. Repeat from here for H2 through H6. |
| Step 7 | 350F | ▲ or ▼ | Use arrow buttons to modify. Hold either button for fast scrolling. Will display in F or C. 250°F (121°C) minimum, 360°F (182°C) maximum. |
| Step 8 | | ENTER | Press ENTER to proceed. t1 displays momentarily. |
| Step 9 | t 1 | Heat Setpoints T1 through T6 | Repeat for t2 through t6. Remember t1=total cook time, and times t2 through t6 indicate time remaining in the cook cycle. |
| Step 10 | 15:00 | ▲ or ▼ | Use arrow buttons to modify. Hold either button for fast scrolling. Display shows MM:SS (minutes:seconds). :00 minimum, 99:55 maximum. |
| Step 11 | | ENTER | Press ENTER to proceed. |
| Step 12 | P | ▲ | Use arrow button to toggle between Open (O) and Pressure (P). |
| Step 13 | | ENTER | Controller proceeds to next heat setpoint (repeats starting at Step 6). If at final pressure setting, program mode exits. |

RETURN TO STEP 6 AND REPEAT THROUGH STEP 13 UNTIL PROGRAMMING IS COMPLETE.

Note: At any time during programming, the time setting can be set to :00 indicating from that point on, the fryer will cook at the last temperature setting entered until the end of the cycle.



PROGRAMMING

PROCESS 2

Programming Process #2 (PC 2) - 6 temperatures, 6 times, load compensation

STEP 2 In sequence, press the following buttons to enter programming mode.



STEP 1 First choose the channel you want to program.



| | WHEN THE COMPUTER DISPLAYS | PRESS BUTTON/ACTION | NOTE |
|---|----------------------------|---------------------------------|---|
| Step 3 | Prog | ENTER | Indicates Programming mode. Press ENTER to proceed. |
| Step 4 | Pc 2 | 2 | Press channel button #2 for selecting process #2. |
| Step 5 | | ENTER | Press ENTER to proceed. |
| Step 6 | H 1 | Heat Setpoints H1 through H6 | H1 displays momentarily. Repeat from here for H2 through H6. |
| Step 7 | 350F | ▲ or ▼ | User arrow buttons to modify. Hold either button for fast scrolling. |
| Step 8 | | ENTER | Press ENTER to proceed. t1 displays momentarily. |
| Step 9 | t 1 | Heat Setpoints t1 through t6 | Repeat for t2 through t6. Remember t1=total cook time, and times t2 through t6 indicate time remaining in the cook cycle. |
| Step 10 | 15:00 | ▲ or ▼ | Use arrow buttons to modify. Hold either button for fast scrolling. Display shows MM:SS (minutes:seconds). :- minimum, 99:55 maximum. |
| Step 11 | | ENTER | Press ENTER to proceed. |
| Step 12 | P | ▲ | Use arrow button to toggle between Open (O) and Pressure (P). |
| Step 13 | | ENTER | Controller proceeds to next heat setpoint (repeats starting at Step 6). If at final pressure setting, program mode exits. |
| Step 14 | Lc | ▲ | Use arrow button to toggle between Straight Time (Str) and Load Compensation (Lc). |
| Step 15 | | | Controller proceeds to next heat setpoint (restarts after Step 6). |
| Return to Step 6 and repeat through Step 15 until bu1 displays, then got to Step 15 | | | |
| Step 16 | bu 1 | Pre-Alarm Setpoints 1 through 6 | bu1 displays momentarily. Repeat Steps 16-18 for pre-alarms bu2 through bu3. |
| Step 17 | 15:00 | ▲ or ▼ | Use arrow buttons to modify. Hold either button for fast scrolling. Display shows MM:SS (minutes:seconds). |
| Step 18 | | ENTER | Press ENTER to exit programming mode. |

Note: At any time during programming, time settings can be set to :00 indicating from that point on, the fryer will

cook at the last setting entered until the end of the cycle.



PROGRAMMING

PROCESS 5

Programming Process #5 (PC 5) - 1 temperature, 1 time

Note: Not all fryers have a Process #5.

STEP 2 In sequence, press the following buttons to enter programming mode.



STEP 1 First choose the channel you want to program.



| | WHEN THE COMPUTER DISPLAYS | PRESS BUTTON/ACTION | NOTE |
|---------|----------------------------|---------------------|--|
| Step 3 | Prog | ENTER | Indicates Programming mode. Press ENTER to proceed. |
| Step 4 | Pc 5 | 5 | Press channel button #5 for selecting process #5. |
| Step 5 | | ENTER | Press ENTER to proceed. |
| Step 6 | H 1 | Heat Setpoint H1 | H1 displays momentarily. |
| Step 7 | 350F | ▲ or ▼ | Use arrow buttons to modify. Hold either button for fast scrolling. Will display in F or C. 250°F (121°C) minimum, 360°F (182°C) maximum. |
| Step 8 | | ENTER | Press ENTER to proceed. t1 displays momentarily. |
| Step 9 | t 1 | Heat Setpoint T1 | t1 displays momentarily. |
| Step 10 | 15:00 | ▲ or ▼ | Use arrow buttons to modify. Hold either button for fast scrolling. Display shows MM:SS (minutes:seconds) :00 minimum, 99:55 maximum. |
| Step 11 | | ENTER | Press ENTER to proceed. |
| Step 12 | P | ▲ or ▼ | Use arrow button to toggle between Open (O) and Pressure (P). |
| Step 13 | | ENTER | Press ENTER to exit. |

Note: At any time during programming, time settings can be set to :00 indicating from that point on, the fryer will

cook at the last setting entered until the end of the cycle.



PROGRAMMING

PROCESS 6

Programming Process #6 (PC 6) - 2 temperatures, 2 times
 Note: Not all fryers have a Process #6.

STEP 2 In sequence, press the following buttons to enter programming mode.



STEP 1 First choose the channel you want to program.



| | WHEN THE COMPUTER DISPLAYS | PRESS BUTTON/ACTION | NOTE |
|---------|----------------------------|--------------------------|---|
| Step 3 | Prog | ENTER | Indicates Programming mode. Press ENTER to proceed. |
| Step 4 | Pc 6 | 6 | Press channel button #6 for selecting process #6. |
| Step 5 | | ENTER | Press ENTER to proceed. |
| Step 6 | H 1 | Heat Setpoints H1 and H2 | H1 displays momentarily. Repeat from here for H2. |
| Step 7 | 350F | ▲ or ▼ | Use arrow buttons to modify. Hold either button for fast scrolling. Will display in F or C. 250°F (121°C) minimum, 360°F (182°C) maximum. |
| Step 8 | | ENTER | Press ENTER to proceed. t1 displays momentarily. |
| Step 9 | t 1 | Time Setpoint t1 and t2 | t1 displays momentarily. Repeat for t2. Remember t1=total cook time and time t2 indicates time remaining in the cook cycle. |
| Step 10 | 15:00 | ▲ or ▼ | Use arrow buttons to modify. Hold either button for fast scrolling. Display shows MM:SS (minutes:seconds). :- minimum, 99:55 maximum. |
| Step 11 | | ENTER | Press ENTER to proceed. |
| Step 12 | P | ▲ or ▼ | Use arrow button to toggle between Open (O) and Pressure (P). |
| Step 13 | | ENTER | Controller proceeds to next heat setpoint (repeat starting at Step 6). If at final pressure setting, program mode will exit. |

Note: At any time during programming, time settings can be set to :00 indicating from that point on, the fryer will

cook at the last setting entered until the end of the cycle.

PROGRAMMING



RUNNING THE FIELD DIAGNOSTICS

Field Diagnostics are used to help diagnose fryer problems. While running the Field diagnostics program, if a problem exists with fryer components or controller, the display will show an error message.

STEP 1 Turn fryer power switch ON.

STEP 2 In sequence, press the following buttons to enter programming mode.

 then  then  then  then 

| | WHEN THE COMPUTER DISPLAYS | PRESS BUTTON/ACTION | NOTE |
|---------|----------------------------|---|---|
| Step 3 | Prog |  | Indicates Programming mode. Press ENTER to proceed. |
| Step 4 | 8888 | | From left to right, on the 4-digit display, all segments of digit 1 light, then all segments of digit 2 light, then digit 3, and digit 4. |
| Step 5 | 88.88 | | All segments of all digits, including the colon, display. |
| Step 6 | Lon | | All the product button LEDs will light. |
| Step 7 | LoFF | | All the product button LEDs will be off. |
| Step 8 | bu 1 | | A medium volume tone will sound. |
| Step 9 | bu 2 | | A high frequency tone will sound. |
| Step 10 | HEAT | | The controller will energize the heater relay. |
| Step 11 | uEnt | | The controller will call for pressure |
| Step 12 | btn | Press each of the 16 buttons | As each button is pressed, the button number, 1 through 16, will be displayed. |
| Step 13 | | Switch Power OFF | Resets computer. |
| Step 14 | | Switch Power ON   | Switch power back ON, holding keys 9 and 10 to reset. |

Note: At any time during programming, time settings can be set to :00 indicating from that point on, the fryer will

cook at the last setting entered until the end of the cycle.



Aqualert®: Aqualert® is software built into the Collectramatic fryer controls that automatically detects the presence of water in the cookpot and prevents the fryer from being used. Aqualert® is included in all electronically controlled fryers with Winston-manufactured controls.

Aqualert works by sensing the rate of the rise in temperature of a liquid inside the fryer cookpot. Water heats up more slowly than cooking oil. When the fryer is heating to cook temperature in the warm-up phase, Aqualert sensors determine, by the rate the temperature rises in the fryer, whether the liquid is water or cooking oil. If the temperature doesn't rise fast enough, Aqualert will *think* that there is water in the fryer and the fryer will stop heating. The fryer will remain in this suspended mode until the temperature of the liquid in the fryer drops below 180°F (82°C), at which point, if you have determined there is no liquid other than cooking oil in the fryer, you should allow the fryer to make another attempt to reach the cook temperature by following the instructions below. The Aqualert sensors will once again try to determine if there is a liquid other than cooking oil in the fryer. If the fryer continues to enter Aqualert mode, contact Winston Customer Care at 1.800.234.5268 or +1.502.495.5400.

INSTRUCTIONS:

 **DANGER: Burn Hazard**

Can cause serious injury.>>DO NOT use any liquids other than cooking oil in fryer cookpot.

If the fryer is not heating up between the temperatures of 180°F (82°C) and 212°F (100°C) and the display toggles between H2O and ALRT, it is locked up due to the Aqualert® sensing program.

1. Check to see if there is water or any other liquid in the cookpot other than cooking oil (cooking oil may be in a solid or liquid state). **If any liquid other than cooking oil is present, it must be removed before operating the fryer.**
2. Check the temperature of the cooking oil in the cookpot. If it is between 180°F (82°C) and 212°F (100°C), it is locked up due to the Aqualert sensing program.

3. Stir the oil with the fryer plugging tool until the temperature of the oil drops below 180°F (82°C). At this point, the fryer heaters will come back on and the fryer will begin to heat up to the set Drop temperature. **DO NOT STIR THE OIL AGAIN UNTIL THE TEMPERATURE REACHES THE SET DROP TEMPERATURE.**
4. When the set temperature is reached, stir the oil vigorously for at least a full minute until the temperature of the oil drops well below the set temperature. **BE SURE TO STIR DOWN IN THE COLLECTOR.**

 **DANGER: Burn Hazard**

Can cause serious injury.>>DO NOT stir cooking oil in collector after first round of cooking each day. Cooking oil may come up and out of cookpot because of cracklings and product fall-off in the collector.

5. For the first frying of the day, allow fryer to heat back up to set DROP temperature. **STIR AND LET TEMPERATURE RISE BACK TO THE SET DROP TEMPERATURE AT LEAST 3 TIMES.**

6.  **CAUTION: Burn Hazard**

Can cause serious injury.>>Carefully feel the bottom, outside surface of the collector. It should be very hot to the touch. If it is not, continue to follow the stirring instructions in Steps 5 and 6 above.

7. When the collector is hot to the touch, place the Heat Plate in the collector and continue to follow the instructions under Operating Instructions (page 12, step 15).

WARRANTY AND TERMS & CONDITIONS

Limited 1 year Warranty (excluding gaskets, lamps, hoses, power cords, glass panels, fryer baskets, batteries, and evaporators). Warranty disclaimer for failure to clean.

WINSTON EXPRESSLY DISCLAIMS ALL OTHER WARRANTIES, EITHER EXPRESS OR IMPLIED, INCLUDING ANY IMPLIED WARRANTY OF FITNESS FOR A PARTICULAR PURPOSE AND ANY IMPLIED WARRANTY OF MERCHANTABILITY.

For complete details on warranty and terms & conditions of sale, go to:

<https://foodservice.winstonind.com/warranty-information/>

Both the Warranty and Terms and Conditions of Sale are integral to this document.

Need Parts?

For more information regarding genuine Winston replacement parts and accessories visit our website.

OEM parts are designed specifically for our products, and can help you save on costly repairs. Protect your warranty coverage with genuine Winston parts. <https://foodservice.winstonind.com/parts-supplies>





Winston Foodservice | 2345 Carton Drive | Louisville, KY 40299
1.800.234.5286 | 1.502.495.5400 | Fax 1.502.495.5458 | www.winstonfoodservice.com